

# **71X Series**

Process Calibrators

## Calibration Manual

## LIMITED WARRANTY & LIMITATION OF LIABILITY

Each Fluke product is warranted to be free from defects in material and workmanship under normal use and service. The warranty period for the 712, 714, 715, 717 1G, 717 30G, 717 100G, 717 300G, 717 500G, 717 1000G, 717 1500G, 717 3000G, 717 5000G, 718 1G, 718 30G, 718 100G, 718 300G, and 718Ex Calibrators is three years and begins on the date of shipment. The warranty period for the 718 Pump assembly is one year and begins on the date of shipment. Parts, product repairs and services are warranted for 90 days. This warranty extends only to the original buyer or end-user customer of a Fluke authorized reseller, and does not apply to fuses, disposable batteries or to any product which, in Fluke's opinion, has been misused, altered, neglected or damaged by accident or abnormal conditions of operation or handling. Fluke warrants that software will operate substantially in accordance with its functional specifications for 90 days and that it has been properly recorded on non-defective media. Fluke does not warrant that software will be error free or operate without interruption.

Fluke authorized resellers shall extend this warranty on new and unused products to end-user customers only but have no authority to extend a greater or different warranty on behalf of Fluke. Warranty support is available if product is purchased through a Fluke authorized sales outlet or Buyer has paid the applicable international price. Fluke reserves the right to invoice Buyer for importation costs of repair/replacement parts when product purchased in one country is submitted for repair in another country.

Fluke's warranty obligation is limited, at Fluke's option, to refund of the purchase price, free of charge repair, or replacement of a defective product which is returned to a Fluke authorized service center within the warranty period.

To obtain warranty service, contact your nearest Fluke authorized service center or send the product, with a description of the difficulty, postage and insurance prepaid (FOB Destination), to the nearest Fluke authorized service center. Fluke assumes no risk for damage in transit. Following warranty repair, the product will be returned to Buyer, transportation prepaid (FOB Destination). If Fluke determines that the failure was caused by misuse, alteration, accident or abnormal condition of operation or handling, Fluke will provide an estimate of repair costs and obtain authorization before commencing the work. Following repair, the product will be returned to the Buyer transportation prepaid and the Buyer will be billed for the repair and return transportation charges (FOB Shipping Point).

THIS WARRANTY IS BUYER'S SOLE AND EXCLUSIVE REMEDY AND IS IN LIEU OF ALL OTHER WARRANTIES, EXPRESS OR IMPLIED, INCLUDING BUT NOT LIMITED TO ANY IMPLIED WARRANTY OF MERCHANTABILITY OR FITNESS FOR A PARTICULAR PURPOSE. FLUKE SHALL NOT BE LIABLE FOR ANY SPECIAL, INDIRECT, INCIDENTAL OR CONSEQUENTIAL DAMAGES OR LOSSES, INCLUDING LOSS OF DATA, WHETHER ARISING FROM BREACH OF WARRANTY OR BASED ON CONTRACT, TORT, RELIANCE OR ANY OTHER THEORY.

Since some countries or states do not allow limitation of the term of an implied warranty, or exclusion or limitation of incidental or consequential damages, the limitations and exclusions of this warranty may not apply to every buyer. If any provision of this Warranty is held invalid or unenforceable by a court of competent jurisdiction, such holding will not affect the validity or enforceability of any other provision.

To locate an authorized service center, visit us on the World Wide Web at [www.fluke.com](http://www.fluke.com) or call Fluke using the phone numbers listed in this manual.

Fluke Corporation  
P.O. Box 9090  
Everett, WA 98206-9090  
U.S.A.

Fluke Europe B.V.  
P.O. Box 1186  
5602 BD Eindhoven  
The Netherlands

ООО «Флюк СИАЙЭС»  
125167, г. Москва,  
Ленинградский проспект дом 37,  
корпус 9, подъезд 4, 1 этаж

# Table of Contents

Title	Page
Introduction .....	1
How to Contact Fluke.....	1
Precautions and Safety Information.....	2
Explanation of International Symbols .....	5
Specifications .....	6
712 Specifications.....	7
Firmware V1.1 and Earlier .....	7
Firmware V1.2 through V1.9 .....	8
Firmware V2.0 and Later.....	9
714 Specifications.....	11
Firmware Earlier than v2.0 .....	11
Firmware V2.0 and Later.....	12
715 Specifications.....	13
Firmware Earlier than V2.0 .....	13
Firmware 2.0 and Later .....	14
717 Specifications.....	15
718 and 718Ex Specifications .....	18
719 Specifications.....	20
Basic Maintenance.....	22
Cleaning.....	22
Replacing the Battery .....	22
718Ex Approved Batteries .....	24
Replacing the Fuse.....	24
Required Equipment .....	26
Verification .....	28
Preparing for Verification .....	28
712 Verification (V1.1 and Earlier).....	28
Resistance Measure Verification.....	28
Resistance Source Verification .....	29
Keypad Test .....	29
Display Verification.....	29
712 Verification (V1.2 through V1.9) .....	30
712 Verification (V2.0 and Later).....	31
714 Verification (Earlier than V2.0).....	32
Thermocouple Measure Verification .....	32

Thermocouple Source Verification .....	33
Keypad Test .....	33
Display Verification .....	34
714 Verification (V2.0 and Later).....	34
Thermocouple Measure Verification .....	34
Thermocouple Source Verification .....	35
715 Verification (Earlier than V2.0).....	36
DC Voltage Source Verification.....	36
DC Current Source Verification.....	36
Keypad Test .....	37
DC Current Measure Verification .....	37
DC Voltage Measure Verification .....	38
Display Verification .....	38
715 Verification (V2.0 and Later).....	39
DC Voltage Source Verification.....	39
DC Current Source Verification.....	39
DC Current Measure Verification .....	40
DC Voltage Measure Verification .....	40
717 Verification .....	41
Pressure Verification .....	41
mA Measure Verification .....	47
mA Loop Power Verification.....	47
Sensor Jack Verification.....	47
718 and 718Ex Verification.....	48
Pressure Verification .....	48
Leak Test Verification.....	50
mA Measure Verification .....	51
mA Loop Power Verification (718 Only).....	51
Sensor Jack Verification.....	51
Display Verification .....	52
719 Verification .....	52
Display Verification .....	52
Pressure Verification .....	52
Leak Test Verification.....	54
mA Measure Verification .....	54
mA Source Verification.....	55
mA Loop Power Verification.....	56
Sensor Jack Verification.....	56
Calibration .....	56
Preparing for Calibration.....	56
712 Calibration (V1.1 and Earlier).....	57
Millivolts Measure .....	57
Resistance Measure .....	58
mA Measure .....	58
712 Calibration (V1.2 through V1.9).....	59
712 Calibration (V2.0 and Later) .....	60
OHMS INPUT .....	61
OHMS OUTPUT Low Range .....	61
OHMS OUTPUT High Range.....	61
714 Calibration (Earlier than V2.0).....	62
Temperature Measure.....	62
Temperature Source .....	62
Thermocouple Block Calibration .....	62
714 Calibration (V2.0 and Later) .....	63
mV OUTPUT .....	63

mV INPUT .....	63
CJC.....	64
715 Calibration (Earlier than V2.0) .....	64
mA/Volts Measure .....	64
mA/Volts Source Measure .....	65
715 Calibration (V2.0 and Later) .....	65
V INPUT .....	66
mV INPUT .....	66
mA INPUT .....	66
V OUTPUT .....	67
mV OUTPUT .....	67
mA OUTPUT .....	67
717 Calibration (Earlier than V2.0) .....	68
mA Measure .....	68
Pressure Measure .....	68
717 Calibration (V2.0 to V3.9) .....	70
mA Measure .....	70
Pressure Measure .....	70
717 Calibration (V4.0 and Later) .....	71
mA Measure .....	71
Pressure Measure .....	72
718 Calibration (Earlier than V2.0) .....	73
mA Measure .....	73
Pressure Measure .....	74
718 Calibration (V2.0 to V3.9) .....	75
mA Measure .....	75
Pressure Measure .....	76
718 Calibration (V4.0 and Later) .....	77
mA Measure .....	77
Pressure Measure .....	78
718Ex Calibration .....	79
719 Calibration (V1.0).....	81
mA Measure .....	81
mA Output Calibration.....	82
Pressure Measure .....	82
Replacement Parts and Accessories.....	84



# List of Tables

Table	Title	Page
1.	International Symbols.....	5
2.	General Specifications .....	6
3.	712 Supported RTD Types .....	7
4.	712 RTD and Ohms Simulation .....	7
5.	712 RTD and Ohms Measurement .....	8
6.	RTD Specifications.....	8
7.	Ohms Specifications.....	9
8.	RTD Specifications.....	9
9.	Ohms Measurement Specifications .....	10
10.	Ohms Source Specifications .....	10
11.	714 Temperature Measure and Thermocouple Simulate .....	11
12.	714 Millivolt Measure and Source .....	11
13.	714 Temperature Measure and Thermocouple Simulate .....	12
14.	714 Millivolt Measure and Source .....	12
15.	715 DC V Input and Output .....	13
16.	715 DC mA Input and Output.....	13
17.	715 DC V Input and Output .....	14
18.	715 DC mA Input and Output.....	14
19.	717 Pressure Specifications.....	15
20.	Pressure Display, Pressure Module Input.....	16
21.	DC mA Input.....	16
22.	717 Range and Resolution.....	17
23.	Pressure Specifications.....	18
24.	Pressure Display, Pressure Module Input.....	18
25.	DC mA Input Input.....	19
26.	718 Range and Resolution.....	19
27.	719 Pressure Sensor Input .....	20
28.	719 Pressure Module Input .....	20
29.	719 DC mA Measure and Source .....	20
30.	719 Pressure Source.....	20
31.	718Ex Approved Batteries.....	24
32.	Verifying a Blown Fuse.....	24
33.	Required Calibration Equipment .....	26
34.	712 Resistance Measure Verification.....	28
35.	712 Resistance Source Verification .....	29

36.	712 Verification RTD Values .....	30
37.	712 Verification Resistance Values.....	30
38.	712 Verification Outputs.....	31
39.	712 Verification RTD Values .....	31
40.	712 Verification Resistance Values.....	32
41.	712 Verification Outputs.....	32
42.	714 Thermocouple Measure Verification .....	32
43.	714 Thermocouple Measure Verification (mA) .....	33
44.	714 Thermocouple Source Verification (mA).....	33
45.	714 Thermocouple Source Verification (Temperature).....	33
46.	714 Thermocouple Measure Verification .....	34
47.	714 Thermocouple Measure Verification (mV) .....	35
48.	714 Thermocouple Source Verification (mV).....	35
49.	714 Thermocouple Source Verification (Temperature).....	35
50.	715 DC Voltage Source Verification (0.000 to 10.000 V).....	36
51.	715 DC Voltage Source Verification (0.00 to 100.00 V).....	36
52.	715 DC Current Source Verification.....	36
53.	715 DC Current Measure Verification .....	37
54.	715 DC Voltage Measure Verification (10.0000 to 0.0000 V).....	38
55.	715 DC Voltage Measure Verification (0.0000 mV to 100.0000 mV) .....	38
56.	715 DC Voltage Source Verification (0.000 to 20.000 V).....	39
57.	715 DC Voltage Source Verification (0.00 to 200.00 mV).....	39
58.	715 DC Current Source Verification.....	39
59.	715 DC Current Measure Verification .....	40
60.	715 DC Voltage Measure Verification (25.0000 to 0.0000 V).....	40
61.	715 DC Voltage Measure Verification (0.0000 mV to 200.0000 mV) .....	41
62.	717 Pressure Verification .....	42
63.	717 mA Measure Verification .....	47
64.	718 and 718Ex Pressure Verification.....	48
65.	718 Leak Test Verification.....	50
66.	718 and 718Ex mA Measure Verification.....	51
67.	719 Pressure Verification .....	53
68.	719 Leak Test Verification.....	54
69.	719 mA Measure Verification .....	54
70.	719 mA Source Verification.....	55
71.	Replaceable Parts and Accessories .....	84



# ***List of Figures***

<b>Figure</b>	<b>Title</b>	<b>Page</b>
1.	Proper Use of Tools (717, 718, and 718Ex Models).....	4
2.	Replacing the Battery .....	22
3.	Replacing the Battery (718 and 719 only).....	23
4.	718Ex Battery Replacement.....	23
5.	Replacing the Fuses (715 shown).....	25
6.	Replacing the Fuse (718 shown) .....	26



## **Introduction**

### **Warning**

**The information provided in this document is for the use of qualified personnel only. Do not perform the verification tests or calibration procedures described in this manual unless you are qualified to do so.**

The information in this manual deals with the 71X Series Process Calibrators (hereafter referred to as “the Calibrator” or the “71X Calibrator”). The 71X Series includes the 712, 714, 715, 717 1G, 717 30G, 717 100G, 717-15G, 717 300G, 717 500G, 717 1000G, 717 1500G, 717 3000G, 717 5000G, 717-10000G, 718 1G, 718 30G, 718 100G, 718 300G, and the 718Ex 30G, 718Ex 100G, and the 719 models.

This manual provides the following information:

- Precautions and safety information
- Specifications
- Basic maintenance (cleaning, replacing the battery and fuses)
- Verification test procedures
- Calibration and calibration adjustment procedures
- Accessories and replaceable parts

## **How to Contact Fluke**

To contact Fluke, call one of the following telephone numbers:

- Technical Support USA: 1-800-44-FLUKE (1-800-443-5853)
- Calibration/Repair USA: 1-888-99-FLUKE (1-888-993-5853)
- Canada: 1-800-36-FLUKE (1-800-363-5853)
- Europe: +31 402-675-200
- Japan: +81-3-6714-3114
- Singapore: +65-6799-5566
- China: +86-400-921-0835
- Brazil: +55-11-3530-8901
- Anywhere in the world: +1-425-446-5500

Or, visit Fluke's website at [www.fluke.com](http://www.fluke.com).

To register your product, visit <http://register.fluke.com>.

To view, print, or download the latest manual supplement, visit <http://us.fluke.com/usen/support/manuals>.

## **Precautions and Safety Information**

Use the Calibrator only as specified in this manual. Otherwise, the protection provided by the Calibrator may be impaired.

A Warning statement identifies conditions and actions that pose hazard(s) to the user; a Caution statement identifies conditions and actions that may damage the Calibrator. The following Warning and Caution statement applies to all 71X Calibrators unless noted:

### **Warning**

**To avoid possible electric shock or personal injury:**

- **Use the 718Ex Calibrator only as described in the User Manual and the Fluke 718Ex CCD (Concept Control Drawing) or the protection provided by the Calibrator may be impaired.**
- **Follow all equipment safety procedures.**
- **Inspect the Calibrator before use. Do not use it if it appears damaged.**
- **Check the test leads for continuity, damaged insulation, or exposed metal. Replace damaged test leads.**
- **When using probes, keep fingers behind the finger guards on the probes.**
- **Make sure the battery door is closed before using the Calibrator.**
- **Never apply more than 30.0 V between the input terminals, or between any terminal and earth ground.**
- **Applying more than 30.0 V to the input terminals invalidates the 718Ex Calibrator's Ex Approval and may result in permanent damage to the unit so it can no longer be used.**
- **Use the proper terminals, mode, and range for the measuring or sourcing application.**
- **When making connections, connect the COM test probe before the live test probe. When disconnecting, disconnect the live probe before the COM probe.**
- **Never use the 718Ex Calibrator with the red holster removed.**
- **Never open the 718Ex Calibrator case. Opening the case invalidates the Calibrator's Ex Approval.**
- **Replace the battery as soon as the  (low battery) symbol appears to avoid false readings that can lead to electric shock. Remove the 718Ex Calibrator from the Ex-hazardous area before opening the battery door.**
- **Use only type 9 V batteries, properly installed in the meter case, to power the meter. For the 718Ex, refer to "718Ex Approved Batteries".**
- **Remove test leads from the Calibrator before opening the battery door.**
- **When servicing the Calibrator, use only specified replacement parts.**

- Do not allow water inside the case.
- When using the Calibrator's internal pressure sensor, do not connect a pressure module at the Calibrator to avoid misleading readings. If both a pressure module and the internal pressure sensor are connected, the Calibrator displays **ONLY** the pressure module measurement. To avoid misleading readings, disconnect the pressure module connector at the Calibrator.
- Remove test leads or attached thermocouple miniplug (714 only) from the Calibrator before opening the battery door.
- Do not operate the Calibrator around explosive gas, vapor or dust.
- 717, 718, 719, and 718Ex only: To avoid a violent release of pressure in a pressurized system, shut off the valve and slowly bleed off the pressure before you attach or detach the Calibrator pressure fitting to the pressure line.
- For 718 (non-Ex) and 719 only: Use only two 9 V batteries, properly installed in the Calibrator case, to power the Calibrator.
- For 717 and 718: Turn off circuit power before connecting the Calibrator mA and COM terminals in the circuit. Place Calibrator in series with the circuit.
- Do not use in a damp or wet environment.

**⚠ Caution**

- To prevent damage to the unit under test, be sure the Calibrator is in the correct mode before connecting the test leads.
- The 71X Series Calibrators contain parts that can be damaged by static discharge. If you open the case, follow the standard practices for handling static sensitive devices. Refer to "Static Awareness".
- Models, 717, 718, and 719 only: To avoid mechanically damaging the Calibrator, do not apply torque between the pressure fitting and the Calibrator case. See Figure 1 for the proper use of tools.

- To avoid overpressure damage, do not apply pressure that exceeds limits listed in the Users Manual for the specific product.
- 717, 718, and 719 only: To avoid corrosion in the pressure sensor, use the Calibrator only with media compatible with glass, ceramic, silicon, RTV, nitrile, (Buna -N) type 303 stainless steel, and nickel.
- 718, 719 and 718Ex only: To avoid damage to the pump, use with dry air and non-corrosive gases only. Use of the optional Fluke 700-ILF In-Line Filter may help isolate the pump from contaminates.

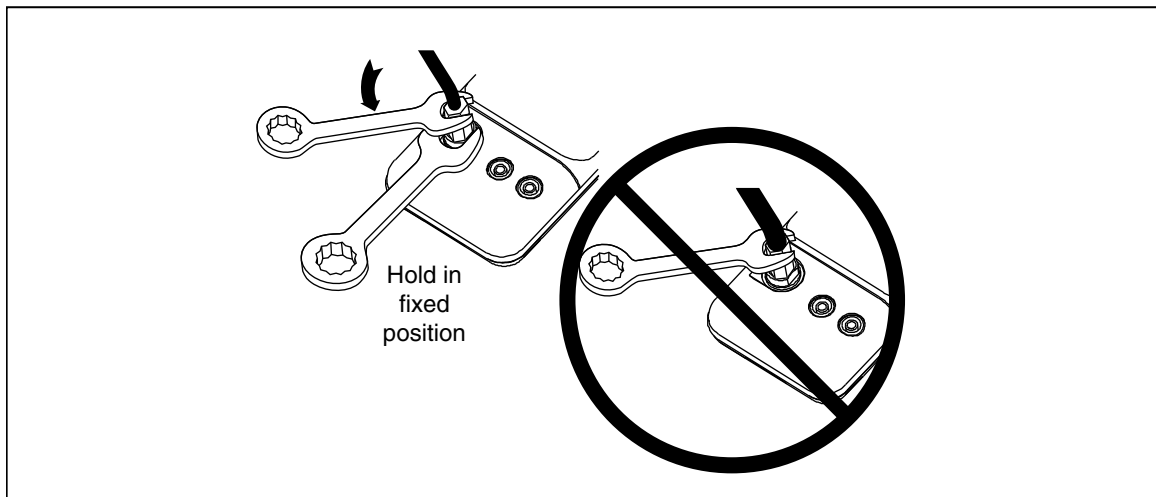















Figure 1. Proper Use of Tools (717, 718, and 718Ex Models)

kf01f.emf

## Explanation of International Symbols

The following symbols are used on the Calibrator or in this calibration manual. Table 1 explains their meaning.

**Table 1. International Symbols**

Symbol	Meaning
	Consult user documentation.
	Power ON/OFF
	Earth
	Fuse
	Battery
	WARNING. HAZARDOUS VOLTAGE. Risk of electric shock.
	WARNING. RISK OF DANGER.
	Double Insulated
	Certified by CSA Group to North American safety standards.
	Pressure
	Conforms to European Union directives
	Conforms to the European Explosive Atmospheres (ATEX) directive.
	Conforms to relevant Australian Safety and EMC standards.
	This product complies with the WEEE Directive marking requirements. The affixed label indicates that you must not discard this electrical/electronic product in domestic household waste. Product Category: With reference to the equipment types in the WEEE Directive Annex I, this product is classed as category 9 "Monitoring and Control Instrumentation" product. Do not dispose of this product as unsorted municipal waste.

## Specifications

Specifications for the 71X Calibrators are based on a one-year calibration cycle and apply for ambient temperatures from +18 °C to +28 °C unless stated otherwise. “Counts” are the number of increments or decrements of the least significant digit. General specifications for all models are in Table 2.

**Table 2. General Specifications**

Maximum voltage applied between any terminal and earth ground or between any two terminals:	30 V
Storage temperature:	712: -20 °C to 60 °C, 718Ex: -40 °C to 71 °C, 719: -30 °C to 60 °C All other models: -40 °C to 60 °C
(718Ex) Pressure Sensor Media:	Non-corrosive gasses only
Operating temperature:	-10 °C to 55 °C
Operating altitude:	3000 meters maximum
Relative humidity:	95 % up to 30 °C 75 % up to 40 °C 45 % up to 50 °C 35 % up to 55 °C
Safety	IEC 61010-1: Pollution degree 2
Electromagnetic Compatibility	
International	IEC 61326-1: Basic Electromagnetic Environment; IEC 61326-2-1 CISPR 11: Group 1, Class A  <i>Group 1: Equipment has intentionally generated and/or uses conductively-coupled radio frequency energy that is necessary for the internal function of the equipment itself.</i> <i>Class A: Equipment is suitable for use in all establishments other than domestic and those directly connected to a low-voltage power supply network that supplies buildings used for domestic purposes. There may be potential difficulties in ensuring electromagnetic compatibility in other environments due to conducted and radiated disturbances.</i> <i>Caution: This equipment is not intended for use in residential environments and may not provide adequate protection to radio reception in such environments. Emissions that exceed the levels required by CISPR 11 can occur when the equipment is connected to a test object.</i> <i>The equipment may not meet the immunity requirements of this standard when test leads and/or test probes are connected.</i>
Korea (KCC)	Class A Equipment (Industrial Broadcasting & Communication Equipment) <i>Class A: Equipment meets requirements for industrial electromagnetic wave equipment and the seller or user should take notice of it. This equipment is intended for use in business environments and not to be used in homes.</i>
USA (FCC)	47 CFR 15 subpart B. This product is considered an exempt device per clause 15.103.
Power requirements: 712, 714, 715, 717	One 9 V battery (IEC 6LR61)
Power requirements: 718	Two 9 V batteries (IEC 6LR61)
Power requirements: 718Ex	See “718Ex Approved Batteries”.
Size: 712, 714, 715, 717	34.9 mm H x 87 mm W x 187 mm L; With holster and Flex-Stand: 52 mm H x 98 mm W x 201 mm L
Size: 718, 718Ex, 719	60 mm H x 87 mm W x 210 mm L; With holster: 66 mm H x 94 mm W x 216 mm L
Weight:	
712	337 g, With holster and Flex-Stand: 587 g
714	332 g, With holster and Flex-Stand: 584 g
715	349 g, With holster and Flex-Stand: 601 g
717 30G, 717 100G	369 g, With holster and Flex-Stand: 624 g
718 30G and 718 100G and 718Ex 30G and 718Ex 100G	737 g, With holster: 992G
719	912 g: With holster



## 712 Specifications

712 Calibrator specifications vary based on the version of the instrument. To display the firmware version for your instrument, start with the 712 off, push and hold , then push the power button. Find the section heading below for the displayed version and use the specification tables in that section to test and calibrate the instrument.

### Firmware V1.1 and Earlier

**Table 3. 712 Supported RTD Types**

RTD Type	Temperature Range and Resolution	Allowable Excitation <sup>[1]</sup>
	°C	mA
Ni 120	-80.0 to 260.0	0.15 to 2.00
Pt 100 385	-200.0 to 800.0	0.15 to 2.00
Pt 200 385	-200.0 to 630.0	0.15 to 2.00
Pt 500 385	-200.0 to 630.0	0.05 to 0.80
Pt 1000 385	-200.0 to 630.0	0.05 to 0.40
Pt 100 392	-200.0 to 630.0	0.15 to 2.00
Pt 100 JIS	-200.0 to 630.0	0.15 to 2.00
	<b>Range and Resolution for Ohms Simulate and Measure</b>	
R <sup>[2]</sup>	15.0 Ω to 400.0 Ω	0.15 to 2.00
R	400.0 Ω to 1500.0 Ω	0.05 to 0.80
R	1500.0 Ω to 3200.0 Ω	0.05 to 0.40

Addresses pulsed transmitters and PICs with pulses ≥100 ms.

[1] This column is for simulate mode only. It shows the allowable excitation current from an ohmmeter or RTD measurement device connected to the Calibrator.

[2] The R annunciator signifies “resistance,” not an RTD type. Select it the same way as an RTD type.

### Resolution

RTD: 0.1 °C  
Ohms: 0.1 Ω

### Temperature Coefficient

0.005 % of ohms range per °C for temperature ranges –10 °C to 18 °C and 28 °C to 55 °C. Ohms ranges are 400 Ω, 1.5 kΩ, and 3.2 kΩ.

**Table 4. 712 RTD and Ohms Simulation**

Ohms Range	Excitation Current from Measurement Device	Accuracy, ±Ω
15 Ω to 400 Ω	0.15 mA to 0.5 mA	0.15
15 Ω to 400 Ω	0.5 mA to 2 mA	0.1
400 Ω to 1.5 kΩ	0.05 mA to 0.8 mA	0.5
1.5 kΩ to 3.2 kΩ	0.05 mA to 0.4 mA	1

Maximum input voltage: 30 V

**Table 5. 712 RTD and Ohms Measurement**

Ohms Range	Accuracy, Four-Wire $\pm\Omega$
15 $\Omega$ to 400 $\Omega$	0.1
400 $\Omega$ to 1.5 k $\Omega$	0.5
1.5 k $\Omega$ to 3.2 k $\Omega$	1
Maximum input voltage: 30 V Excitation current from 712: 0.3 mA	

*Firmware V1.2 through V1.9*

**Table 6. RTD Specifications**

RTD Type	Range °C (°F)	Accuracy (°C)			Allowable Excitation (mA)
		Input		Output	
		4-Wire	2-Wire & 3-Wire		
Ni 120	-80.0 to 260.0 (-112.0 to 500.0)	0.2	0.3	0.2	0.1 to 3.0
Pt 100 385	-200.0 to 800.0 (-328.0 to 1472.0)	0.33	0.5	0.33	0.1 to 3.0
Pt 200 385	-200.0 to 250.0 (-328.0 to 482.0)	0.2	0.3	0.2	0.1 to 3.0
	250.0 to 630.0 (482.0 to 1166.0)	0.8	1.6	0.8	
Pt 500 385	-200.0 to 500.0 (-328.0 to 932.0)	0.3	0.6	0.3	0.05 to 0.8
	500.0 to 630.0 (932.0 to 1166.0)	0.4	0.9	0.4	
Pt 1000 385	-200.0 to 100.0 (-328.0 to 212.0)	0.2	0.4	0.2	0.05 to 0.4
	100.0 to 630.0 (212.0 to 1166.0)	0.2	0.5	0.2	
Pt 100 392 (3926)	-200.0 to 630.0 (-328.0 to 1166.0)	0.3	0.5	0.3	0.1 to 3.0
Pt 100 JIS (3916)	-200.0 to 630.0 (-328.0 to 1166.0)	0.3	0.5	0.3	0.1 to 3.0
Addresses pulsed transmitters and PLCs with pulses as short as 5 ms. Allowable Excitation is for Output mode only. It shows the allowable excitation current from an ohmmeter or RTD measurement device connected to the Calibrator. Excitation current from 712: 0.2 mA. Maximum input voltage: 30 V					

**Table 7. Ohms Specifications**

Ohms Range	Input Accuracy 4-Wire $\pm\Omega$	Output Accuracy $\pm\Omega$	Allowable Excitation (mA)
0 $\Omega$ to 400 $\Omega$	0.1	0.15	0.1 to 0.5
		0.1	0.5 to 3.0
400 $\Omega$ to 1.5 k $\Omega$	0.5	0.5	0.05 to 0.8
1.5 k $\Omega$ to 3.2 k $\Omega$	1	1	0.05 to 0.4

Allowable Excitation is for Output mode only. It shows the allowable excitation current from an ohmmeter or RTD measurement device connected to the Calibrator.  
Excitation current from 712: 0.2 mA.  
Maximum input voltage: 30 V

**Resolution**

RTD: 0.1 °C  
Ohms: 0.1  $\Omega$   
Rev 1.3 or Later: < 400  $\Omega$  0.01  $\Omega$   
> 400  $\Omega$  0.1  $\Omega$

**Temperature Coefficient**

0.005 % of ohms range per °C for temperature ranges -10 °C to 18 °C and 28 °C to 55 °C. Ohms ranges are 400  $\Omega$ , 1.5 k $\Omega$ , and 3.2 k $\Omega$ .

**Firmware V2.0 and Later**

**Table 8. RTD Specifications**

RTD Type	Range °C	Accuracy (°C) *			Allowable Excitation (mA)
		Input		Source	
		4-Wire	2-Wire & 3-Wire		
Ni 120	-80.0 to 260.0	0.20	0.25	0.2	0.1 to 3.0
Pt 100 385	-200.0 to 100.0	0.20	0.28	0.2	0.1 to 3.0
	100.0 to 300.0	0.30	0.40	0.3	
	300.0 to 600.0	0.40	0.52	0.4	
	600.0 to 800.0	0.50	0.65	0.5	
Pt 200 385	-200.0 to 100.0	0.80	1.00	0.8	0.05 to 0.8
	100.0 to 300.0	0.90	1.15	0.9	
	300.0 to 630.0	1.00	1.20	1.0	
Pt 500 385	-200.0 to 100.0	0.40	0.60	0.4	0.05 to 0.8
	100.0 to 300.0	0.50	0.75	0.5	
	300.0 to 630.0	0.60	0.90	0.6	

Table 8. RTD Specifications (cont.)

RTD Type	Range °C	Accuracy (°C) *			Allowable Excitation (mA)
		Input		Source	
		4-Wire	2-Wire & 3-Wire		
Pt 1000 385	-200.0 to 100.0	0.20	0.25	0.2	0.05 to 0.4
	100.0 to 300.0	0.30	0.40	0.3	
	300.0 to 630.0	0.40	0.52	0.4	
Pt 100 392 (3926)	-200.0 to 100.0	0.20	0.28	0.2	0.1 to 3.0
	100.0 to 300.0	0.30	0.40	0.3	
	300.0 TO 630.0	0.40	0.52	0.4	
Pt 100 JIS 3916	-200.0 to 100.0	0.20	0.28	0.2	0.1 to 3.0
	100.0 to 300.0	0.30	0.40	0.3	
	300.0 to 630.0	0.40	0.52	0.4	

Addresses pulsed transmitters and PLCs with pulses as short as 5 ms.  
Excitation current from 712: 0.2 mA.  
Maximum input voltage: 30 V  
\*2-wire: Does not include lead resistance  
3-wire: Assumes matched leads

Table 9. Ohms Measurement Specifications

Ohms Range	Accuracy *	
	4-Wire	2- and 3-wire
0 Ω to 400 Ω	0.025 % ±0.05 Ω	0.025 % ±0.1 Ω
400 Ω to 4000 Ω	0.025 % ±0.05 Ω	0.025 % ±0.55 Ω

Excitation current: 0.2 mA.  
Maximum input voltage: 30 V  
\*2-wire: Does not include lead resistance  
3-wire: Assumes matched leads

Table 10. Ohms Source Specifications

Ohms Range	Excitation Current from Measurement Device	Accuracy
5 to 400 Ω	0.1 to 0.5 mA	0.025 % ±0.1 Ω
5 to 400 Ω	0.5 to 3.0 mA	0.025 % ±0.05 Ω
400 to 1500 Ω	0.05 to 0.8 mA	0.025 % ±0.5 Ω
1500 to 4000 Ω	0.05 to 0.4 mA	0.025 % ±0.5 Ω

**Resolution**

RTD: 0.1 °C  
Ohms: 0.1 Ω  
Rev 1.3 or Later: < 400 Ω 0.01 Ω  
> 400 Ω 0.1 Ω

### Temperature Coefficient

0.005 % of ohms range per °C for temperature ranges –10 °C to 18 °C and 28 °C to 55 °C. Ohms ranges are 400 Ω, 1.5 kΩ, and 4.0 kΩ.

### 714 Specifications

714 Calibrator specifications vary based on the version of the instrument. To display the firmware version for your instrument, start with the 714 off, push and hold , then push the power button. Find the section heading below for the displayed version and use the specification tables in that section to test and calibrate the instrument.

#### Firmware Earlier than v2.0

**Table 11. 714 Temperature Measure and Thermocouple Simulate**

TC Type	Resolution	Error	Reference Junction Error
J, K, T, E, L, U	0.1 °C	±(0.3 °C + 10 μV)	±0.2 °C
B, R, S	1 °C	±(0.3 °C + 10 μV)	±0.2 °C
Maximum input voltage: 30 V Temperature Coefficient: 0.05 x specified accuracy per °C for temperature ranges – 10 °C to 18 °C and 28 °C to 55 °C			

**Table 12. 714 Millivolt Measure and Source**

Range	Resolution	Accuracy
-10 mV to 75 mV	0.01 mV	±(0.025 % of range (75 mV) + 1 count)
Maximum input voltage: 30 V		

*Firmware V2.0 and Later*

**Table 13. 714 Temperature Measure and Thermocouple Simulate**

TC Type	Range °C	Accuracy °C *
J	-210.0 to 0.0	0.6
	0.0 to 800.0	0.4
	800.0 to 1200.0	0.5
K	-200.0 to 0.0	0.8
	0.0 to 1000.0	0.5
	1000.0 to 1372.0	0.7
T	-250.0 to 0.0	0.8
	0.0 to 400.0	0.4
E	-250.0 to -100.0	0.8
	-100.0 to 1000.0	0.4
R	-20.0 to 0.0	2.0
	0.0 to 1787.0	1.4
S	-20.0 to 0.0	2.0
	0.0 to 1767.0	1.4
B	600.0 to 800.0	1.4
	800.0 to 1000.0	1.5
	1000.0 to 1820.0	1.7
L	-200.0 to 0.0	0.45
	0.0 to 900.0	0.4
U	-200.0 to 0.0	0.7
	0.0 to 600.0	0.45
Maximum input voltage: 30 V		
* Includes 0.2 °C cold junction compensation (CJC) error		

**Table 14. 714 Millivolt Measure and Source**

Range	Resolution	Accuracy
-10 mV to 75 mV	0.001 mV	0.015 % ±10 µV
Maximum input voltage: 30 V		
Maximum source current is 1.0 mA		

## 715 Specifications

715 Calibrator specifications vary based on the version of the instrument. To display the firmware version for your instrument, start with the 715 off, push and hold , then push the power button. Find the section heading below for the displayed version and use the specification tables in that section to test and calibrate the instrument.

### Firmware Earlier than V2.0

**Table 15. 715 DC V Input and Output**

Range	Resolution	Accuracy, ±(% of Reading + Counts)
100 mV	0.01 mV	0.02 % + 2
10 V	0.001 V	0.02 % + 2
Input impedance: 2 MΩ (nominal), < 100 pF Overvoltage protection: 30 V Voltage drive capability: 1 mA		

**Table 16. 715 DC mA Input and Output**

Range	Resolution	Accuracy, ±(% of Reading + Counts)
24 mA	0.001 mA	0.02 % + 2
Overload protection: 125 mA, 250 V fast acting fuse mA Output: 0 % = 4 mA, 100 % = 20 mA		

### Temperature Coefficient

0.005 % of ohms range per °C for temperature ranges –10 °C to 18 °C and 28 °C to 55 °C

### Source mode

Compliance: 1000 Ω at 20 mA for battery voltage ≥6.8 V (700 Ω at 20 mA for battery voltage 5.8 to 6.8 V)

### Simulate mode

External loop voltage requirement: 24 V nominal, 30 V maximum, 12 V minimum

### Loop Power

24 V ±10 %

*Firmware 2.0 and Later*

**Table 17. 715 DC V Input and Output**

Range	Resolution	Accuracy, ±(% of Reading + Counts)
200 mV	0.01 mV	0.015 % + 2
20 V output	0.001 V	0.01 % + 2
25 V input		
Input impedance: 1 MΩ (nominal), <100 pF Overvoltage protection: fuseless Voltage drive capability: 1 mA		

**Table 18. 715 DC mA Input and Output**

Range	Resolution	Accuracy, ±(% of Reading + Counts)
24 mA	0.001 mA	0.01 % + 2
Overload protection: fuseless		

*Temperature Coefficient*

0.005 % of ohms range per °C for temperature ranges –10 °C to 18 °C and 28 °C to 55 °C

*Source mode*

Compliance: 1000 Ω at 20 mA for battery voltage ≥6.8 V (700 Ω at 20 mA for battery voltage 5.8 to 6.8 V)

*Simulate mode*

External loop voltage requirement: 24 V nominal, 30 V maximum, 12 V minimum

*Loop Power*

24 V Nominal



## 717 Specifications

Accuracy is specified for 1 year after calibration at operation temperatures of -10 °C to +55 °C. To show the firmware version, start with the unit off and push and hold the lower center button, it will be **MAX** or **SWITCH TEST**, then push **⊙**.

### Pressure

**Table 19. 717 Pressure Specifications**

Version 1.2 or Lower				
Model	Range SI	Range Metric	Max SI	Max Metric
717-30 G	(0 to 30) PSI	0 to 206.85 kPa	90 PSI	620 kPa
Version 1.3 to 3.9				
717-1G	(-1 to 1) PSI	(-7 to 7) kPa	5 PSI	34.5 kPa
717-30G	(-12 to 30) PSI	(-83 to 207) kPa	60 PSI	413 kPa
717-100G	(-12 to 100) PSI	(-83 to 690) kPa	200 PSI	1379 kPa or 1.4 MPa
717-300G	(-12 to 300) PSI	(-83 to 2068) kPa or 2.1 mPa	375 PSI	2586 kPa or 2.6 MPa
717-500G	(0 to 500) PSI	3447 kPa or 3.4 MPa	1000 PSI	6895 kPa or 6.9 MPa
717-1000G	(0-1000) PSI	6895 kPa or 6.9 MPa	2000 PSI	13790 kPa or 13.8 MPa
717-1500G	(0-1500) PSI	10342 kPa or 10.3 MPa	3000 PSI	20684 kPa or 20.7 MPa
717-3000G	(0-3000) PSI	20684 kPa or 20.7 MPa	6000 PSI	41369 kPa or 41.4 MPa
717-5000G	(0-5000) PSI	34474 kPa or 34.5 MPa	10000 PSI	68948 kPa or 69 MPa
<p><b>Accuracy:</b> Pressure Accuracy is <math>\pm 0.05</math> % of range 18 °C to 28 °C.</p> <p><b>Temperature coefficient:</b> 0.01 % of range per °C for temperature ranges of between 10 °C to 18 °C and 28 °C to 55 °C.</p>				
Version 4.0 or Higher				
Model	Range	Max	Accuracy <sup>[1]</sup>	
			6 months	1 year
717 1G	-1 to 1 PSI	5 PSI	0.050 %	0.050 %
	-7 to 7 kPa	34.5 kPa		
717 15G	-12 to 15 PSI	30 PSI	0.025 %	0.035 %
	-83 to 103 kPa	207 kPa		
717 30G	-12 to 30 PSI	60 PSI	0.025 %	0.035 %
	-83 to 207 kPa	413 kPa		
717 100G	-12 to 100 PSI	200 PSI	0.025 %	0.035 %
	-83 to 690 kPa	1.4 MPa		
717 300G	-12 to 300 PSI	375 PSI	0.035 %	0.050 %
	-83 to 2.1 mPa	2.6 MPa		
717 500G	0 to 500 PSI	1000 PSI	0.025 %	0.035 %
	0 to 3.4 mPa	6.9 MPa		

**Table 19. 717 Pressure Specifications (cont.)**

Model	Range	Max	Accuracy <sup>[1]</sup>	
			6 months	1 year
717 1000G	0 to 1000 PSI	2000 PSI	0.025 %	0.035 %
	0 to 6.9 mPa	13.8 MPa		
717 1500G	0 to 1500 PSI	3000 PSI	0.025 %	0.035 %
	0 to 10.3 mPa	20.7 MPa		
717 3000G	0 to 3000 PSI	6000 PSI	0.025 %	0.035 %
	0 to 20.7 mPa	41.4 MPa		
717 5000G	0 to 5000 PSI	10000 PSI	0.025 %	0.035 %
	0 to 34.5 mPa	69 MPa		
717 10000G	0 to 10000 PSI	15000 PSI	0.035 %	0.050 %
	0 to 69 mPa	103.4 MPa		

[1] In an RF field of 1 V/m to 3 V/m between the frequencies of 1.4 GHz to 2.0 GHz, add 120 counts to specified accuracy.

**Table 20. Pressure Display, Pressure Module Input**

Range	Resolution	Accuracy
Refer to the Instruction Sheet for the pressure module		

**Table 21. DC mA Input**

	Range	Resolution	Accuracy, ±(% of Reading + Counts)
717 Version 2.9 or lower	24 mA	0.001 mA	0.025 + 1
717 Version 3.0 or higher	24 mA	0.001 mA	0.015 + 2

**Table 22. 717 Range and Resolution**

	<b>1</b>	<b>15</b>	<b>30</b>	<b>100</b>	<b>300</b>	<b>500</b>	<b>1000</b>	<b>1500</b>	<b>3000</b>	<b>5000</b>	<b>10000</b>
Range	-1 to 1	-12 to 15	-12 to 30	-12 to 100	-12 to 300	0 to 500	0 to 1000	0 to 1500	0 to 3000	0 to 5000	0 to 10000
PSI	1.0000	15.000	30.000	100.00	300.00	500.00	1000.0	1500.0	3000.0	5000.0	10000
bar	0.0689	1.0342	2.0684	6.8947	20.684	34.474	68.947	103.42	206.84	344.74	689.48
mbar	68.948	1034.2	2068.4	6894.8	20684	34474	68948	NA	NA	NA	NA
kPa	6.8948	103.42	206.84	689.48	2068.4	3447.4	6894.8	10342	20684	34474	68948
kg/cm2	0.0703	1.0546	2.1092	7.0307	21.092	35.153	70.307	105.46	210.92	351.53	703.06
cmH2O@ 4 °C	70.309	1054.6	2109.3	7030.9	21093	35154	70309	NA	NA	NA	NA
cmH2O@ 20 °C	70.434	1056.5	2113.0	7043.4	21130	35217	70434	NA	NA	NA	NA
inH2O@ 4 °C	27.681	415.12	830.42	2768.1	8304.2	13840	27681	41521	83042	NA	NA
inH2O@ 20 °C	27.730	415.95	831.89	2773.0	8318.9	13865	27730	41595	83189	NA	NA
mmHg@ 0 °C	51.715	776.25	1551.5	5171.5	15515	25858	51715	NA	NA	NA	NA

**Overload Protection**

Fuseless overvoltage protection

**Temperature Coefficient**

0.005 % of range per °C for temperature ranges of between -10 °C to 18 °C and 28 °C to 55 °C.

**Loop Supply**

24 V dc nominal

**Pressure Module Input**

Determined by pressure module

### 718 and 718Ex Specifications

Accuracy is specified for 1 year after calibration at operating temperatures of -10 °C to +55 °C.

To display firmware version, start with the unit off, push and hold **MAX** or **SWITCH TEST** then push **Ⓞ**.

**Table 23. Pressure Specifications**

718 Version 1.3 to 3.9 718 Ex Versions Under 1.9				
Model	Range SI	Range Metric	Max SI	Max Metric
718-1G	(-1 to 1) PSI	(-7 to 7) kPa	5 PSI	34.5 kPa
718-30G	(-12 to 30) PSI	(-83 to 207) kPa	60 PSI	413 kPa
718-100G	(-12 to 100) PSI	(-83 to 690) kPa	200 PSI	1379 kPa or 1.4 MPa
718-300G	(-12 to 300) PSI	(-83 to 2068) kPa or 2.1 MPa	375 PSI	2586 kPa or 2.6 MPa
<b>Accuracy:</b> Pressure Accuracy is $\pm 0.05\%$ of range <b>Temperature coefficient:</b> .01 % of range per °C for temperature ranges of between -10 °C to 18 °C and 28 °C to 55 °C.				
718 Version 4.0 or Higher 718 Ex V 2.0 and Higher				
Model	Range	Max	Accuracy <sup>[1]</sup> Pressure accuracy is $\pm$ % of positive range	
			6 months	1 year
718-1G	-1 to 1 PSI	5 PSI	0.050 %	0.050 %
	-7 to 7 kPa	34.5 kPa		
718-30G	-12 to 30 PSI	60 PSI	0.025 %	0.035 %
	-83 to 207 kPa	413 kPa		
718-100G	-12 to 100 PSI	200 PSI	0.025 %	0.035 %
	-83 to 690 kPa	1.4 MPa		
718-300G	-12 to 300 PSI	375 PSI	0.035 %	0.050 %
	-83 to 2.1 mPa	2.6 MPa		
[1] In an RF field of 1 V/m to 3 V/m between the frequencies of 1.4 GHz to 2.0 GHz, add 120 counts to specified accuracy.				

**Table 24. Pressure Display, Pressure Module Input**

Range	Resolution	Accuracy
Refer to the Instruction Sheet for the pressure module		

**Table 25. DC mA Input**

	Range	Resolution	Accuracy, $\pm$ (% of Reading + Counts)
718: Version 2.9 and lower	24 mA	0.001 mA	0.025 + 1
718: Version 3.0 and higher	24 mA	0.001 mA	0.015 + 2
718 EX	24 mA	0.001 mA	0.02 + 2

**Table 26. 718 Range and Resolution**

	1	30	100	300
Range	-1 to 1	-12 to 30	-12 to 100	-12 to 300
PSI	1.0000	30.000	100.00	300.00
bar	0.0689	2.0684	6.8947	20.684
mbar	68.948	2068.4	6894.8	20684
kPa	6.8948	206.84	689.48	2068.4
kg/cm <sup>2</sup>	0.0703	2.1092	7.0307	21.092
cmH <sub>2</sub> O@ 4 °C	70.309	2109.3	7030.9	21093
cmH <sub>2</sub> O@ 20 °C	70.434	2113.0	7043.4	21130
inH <sub>2</sub> O@ 4 °C	27.681	830.42	2768.1	8304.2
inH <sub>2</sub> O@ 20 °C	27.730	831.89	2773.0	8318.9
mmHg@ 0 °C	51.715	1551.5	5171.5	15515
inHg@ 0 °C	2.0360	61.081	203.60	610.81

**Overload Protection**

Fuseless overvoltage protection

**Temperature Coefficient**

0.005 % of range per °C for temperature ranges of between -10 °C to 18 °C and 28 °C to 55 °C.

**Loop Supply**

718: 24 V dc nominal

718 EX: No loop Supply

**Pressure Module Input**

Determined by pressure module

## 719 Specifications

Specifications are based on a one-year calibration cycle and apply for ambient temperature from +18 °C to +28 °C unless stated otherwise. Counts are the number of increments or decrements of the least significant digit.

**Table 27. 719 Pressure Sensor Input**

Model	Range	Resolution	Accuracy <sup>[1]</sup>	Max Non-destructive Pressure
30G	-12 to 30.0 PSI	0.001	±0.025 % of positive Range (6 months calibration)	60 PSI
100G	-12 to 100.0 PSI	0.01	±0.035 % of positive Range (1-year calibration)	200 PSI

Temperature coefficient: 0.01 % of range per °C for temperature ranges -10 °C to 18 °C and 28 °C to 55 °C

[1] In an RF field of 3 V/m between the frequencies of 1.6 GHz and 2.0 GHz, add 120 counts to specified accuracy.

**Table 28. 719 Pressure Module Input**

Range	Resolution	Accuracy
(determined by Pressure Module)		

**Table 29. 719 DC mA Measure and Source**

Range	Resolution	Accuracy <sup>[1]</sup> ±(% of Reading + Counts)
24 mA	0.001 mA	0.015 + 2

Maximum load on mA source is 1000 Ω. With HART resistor on, maximum load is 750 Ω.  
Fuseless overload protection

Temperature coefficient: 0.005 % of range per °C for temperature ranges -10 °C to 18 °C and 28 °C to 55 °C

[1] In an RF field of 3 V/m between the frequencies of 150 MHz and 250 MHz, add 75 counts to specified accuracy.

### Loop Supply

24 V dc nominal

**Table 30. 719 Pressure Source**

Model	Range
30G	-11 to 36.0 PSI
100G	-11 to 120.0 PSI



# Static Awareness



Semiconductors and integrated circuits can be damaged by electrostatic discharge during handling. This notice explains how to minimize damage to these components.

1. Understand the problem.
2. Learn the guidelines for proper handling.
3. Use the proper procedures, packaging, and bench techniques.

Follow these practices to minimize damage to static sensitive parts.

To prevent electric shock or personal injury. De-energize the product and all active circuits before opening a product enclosure, touching or handling any PCBs or components.

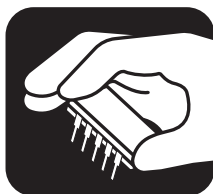

- Minimize handling.
- Handle static-sensitive parts by non-conductive edges.
- Do not slide static-sensitive components over any surface.
- When removing plug-in assemblies, handle only by non-conductive edges.
- Never touch open-edge connectors except at a static-free work station.

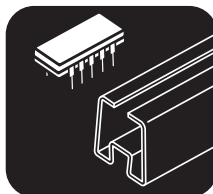

- Keep parts in the original containers until ready for use.
- Use static shielding containers for handling and transport.
- Avoid plastic, vinyl, and Styrofoam® in the work area.



- Handle static-sensitive parts only at a static-free work station.
- Put shorting strips on the edge of the connector to help protect installed static-sensitive parts.
- Use anti-static type solder extraction tools only.
- Use grounded-tip soldering irons only.

## Basic Maintenance

For maintenance procedures not described in this manual, contact an authorized service center.

### Cleaning

Periodically wipe the case with a damp cloth and mild detergent. Do not use abrasives or solvents.

### Replacing the Battery

#### **⚠⚠ Warning**

To avoid false readings, which could lead to possible electric shock or personal injury, replace the battery as soon as the battery indicator (➔) appears.

To replace the battery in models 712, 714, 715, and 717, refer to Figure 2.

To replace batteries in 718 and 719 models, refer to Figure 3.

To replace the battery in model 718Ex, refer to Figure 4 and Table 31.

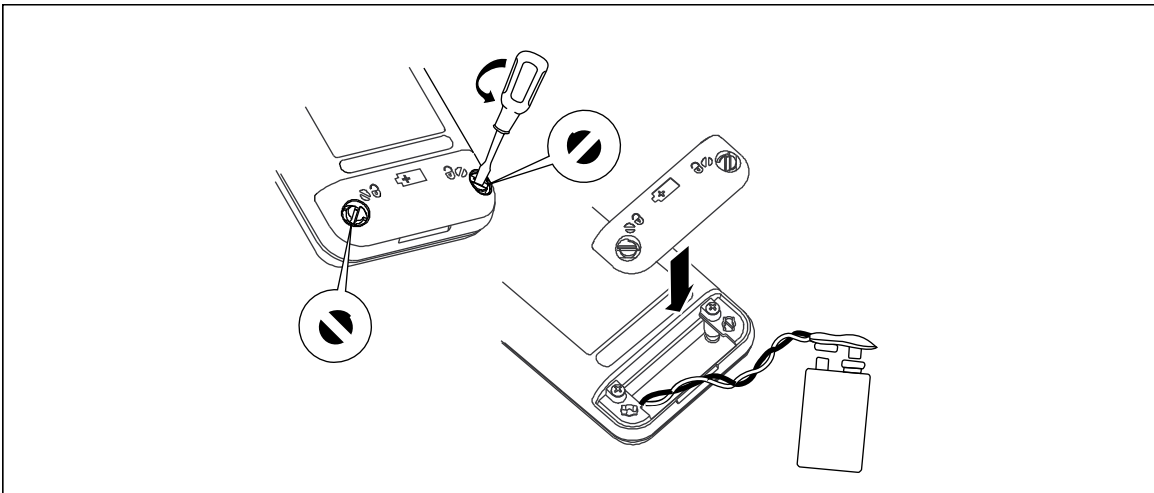
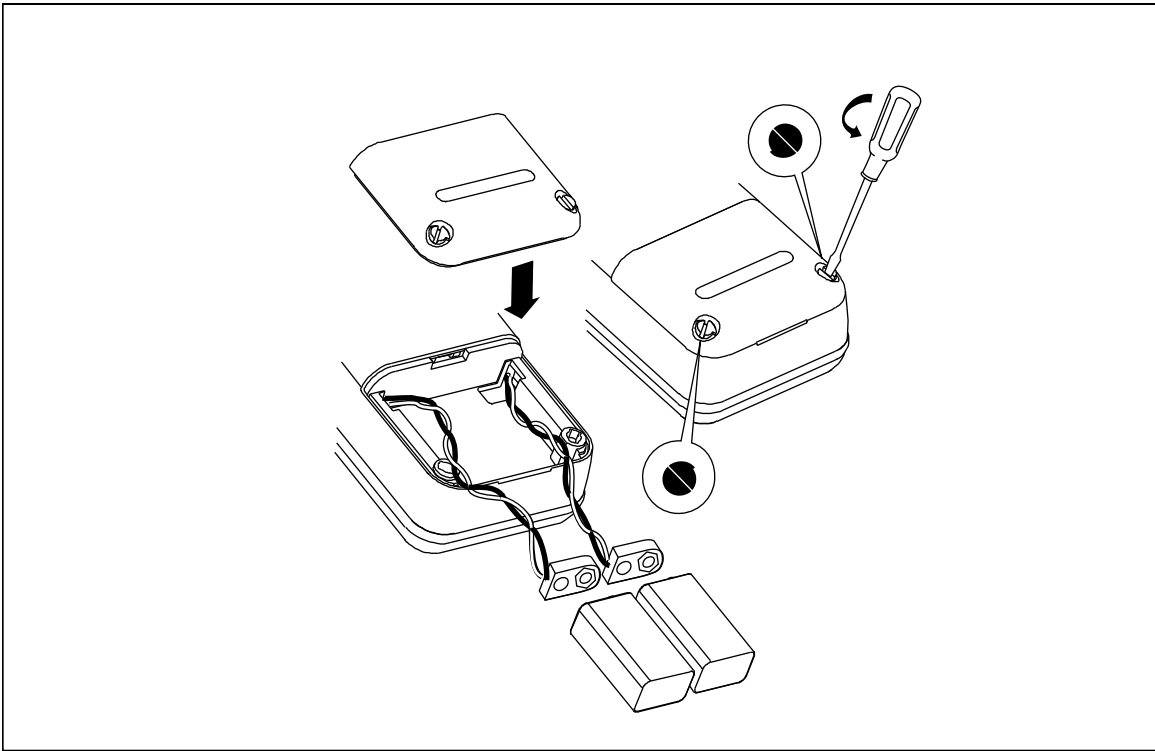

Figure 2. Replacing the Battery

it071.emf





Wh008f.emf

**Figure 3. Replacing the Battery (718 and 719 only)**

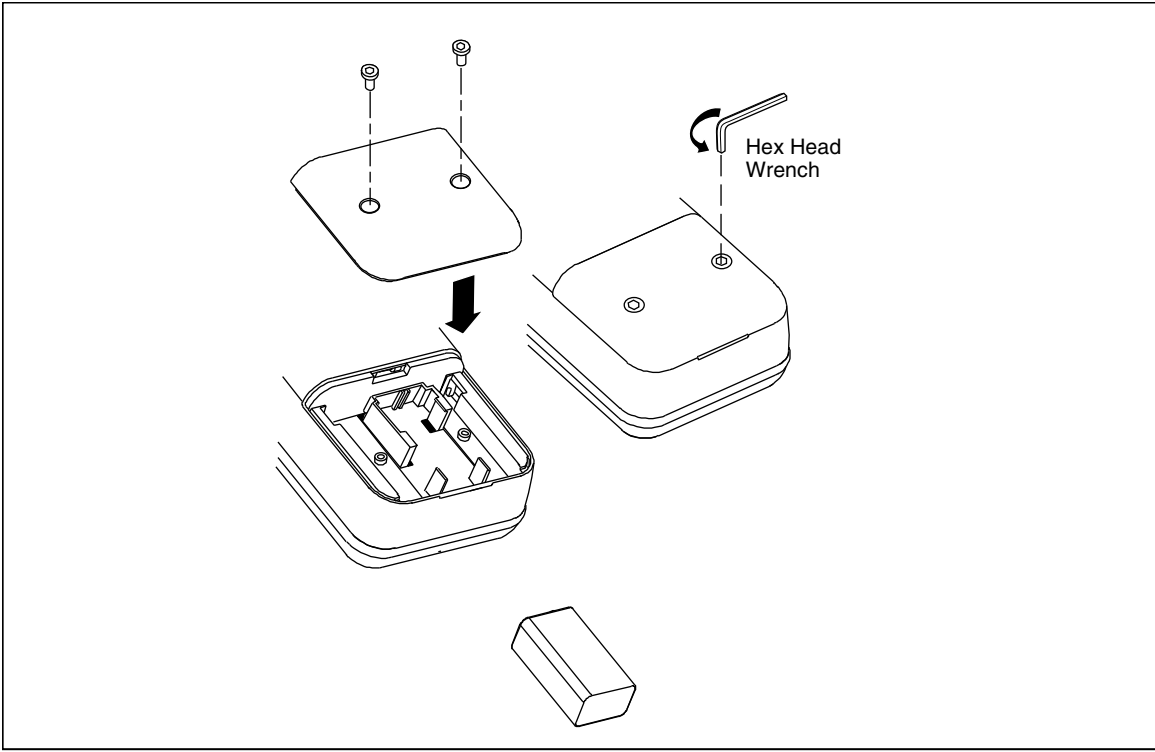

wh009f.emf

**Figure 4. 718Ex Battery Replacement**

### 718Ex Approved Batteries

For a list of 718Ex approved batteries, refer to Table 31.

**Table 31. 718Ex Approved Batteries**

Battery	Manufacturer	Type
Alkaline, 9-volt	Duracell	6LR61/MN1604
Alkaline Ultra, 9-volt	Duracell	6LR61/MX1604
Alkaline Energizer, 9-volt	Eveready	6LR61/522
Alkaline Power Line Industrial Battery, 9-volt	Panasonic	6LR61.9V

### Replacing the Fuse

#### Warning

To avoid personal injury or damage to the Calibrator, use only a **0.125A 250V fast fuse, Littelfuse® 2AG.**

To check if the fuse(s) are blown, refer to Table 32.

**Table 32. Verifying a Blown Fuse**

Calibrator Model	Determining a Blown Fuse
712 V1.1	Put the Calibrator in simulate mode (OUTPUT on the display) and check for proper resistance at the Calibrator's OUTPUT terminals. An open or very high impedance suggests fuse F1 is blown.
712 V1.2	Fuse F1 is probably blown if no current comes from the center jacks when in input 2W mode. Fuse F2 is probably blown when output mode will not work.
712 ≥V2.0	Fuseless overvoltage protection.
717 Series <V1.9 718 Series <V1.9	Fuse F1 is probably blown if the mA measurement display reading does not respond to current applied to the current (mA) inputs.
717 Series ≥V2.0 718 Series ≥V2.0 719 Series	Fuseless overvoltage protection.
714 <V1.9	Fuse F1 is probably blown if, in the input mode, the Calibrator always reads OL, even with a thermocouple connected.
714 ≥V2.0	Fuseless overvoltage protection.
715	Fuse F1 is probably blown if: <ul style="list-style-type: none"> <li>in the mA input mode, the Calibrator always reads 0.000, even with a signal applied.</li> <li>in the mA output mode, with a short across the mA OUTPUT jacks, OL is flashing on the display.</li> </ul> Fuse F2 is probably blown if: <ul style="list-style-type: none"> <li>in the V output mode, with the test leads removed from the Calibrator, the display flashes OL.</li> <li>in the V input mode, the Calibrator always displays OL, even with a signal applied that is within the measurement range.</li> </ul>
715 ≥V2.0	Fuseless overvoltage protection.
718Ex	No user serviceable fuse. An open fuse voids safety certification. The unit should be returned to Fluke for repair.

Replace the fuse(s) as follows, refer to Figures 5 and 6:

1. Remove the test leads and turn the Calibrator off.
2. Remove the battery door.
3. Remove the three Phillips-head screws from the case bottom and turn the case over.
4. Gently lift the top cover from the end nearest the input jacks until it unsnaps from the bottom cover.
5. Replace the fuse(s) with a 0.125 A 250 V fast fuse, Littelfuse® type 2AG. F1 and F2 are the same type on the 715 and 712 V1.2.
6. (712, 714, and 715 only)  
Fit the top and bottom covers together, engaging the two snaps. Make sure that the gasket is properly seated. Reinstall the three screws.

(717 and 718 only)

Carefully fit the case top and circuit board assembly together, making sure that the O-ring is properly seated between the pressure sensor and the pressure fitting on the case top. Fit the case bottom onto the case top, engaging the two snaps near the display end of the case. Reinstall the three screws.

7. Replace the battery door.

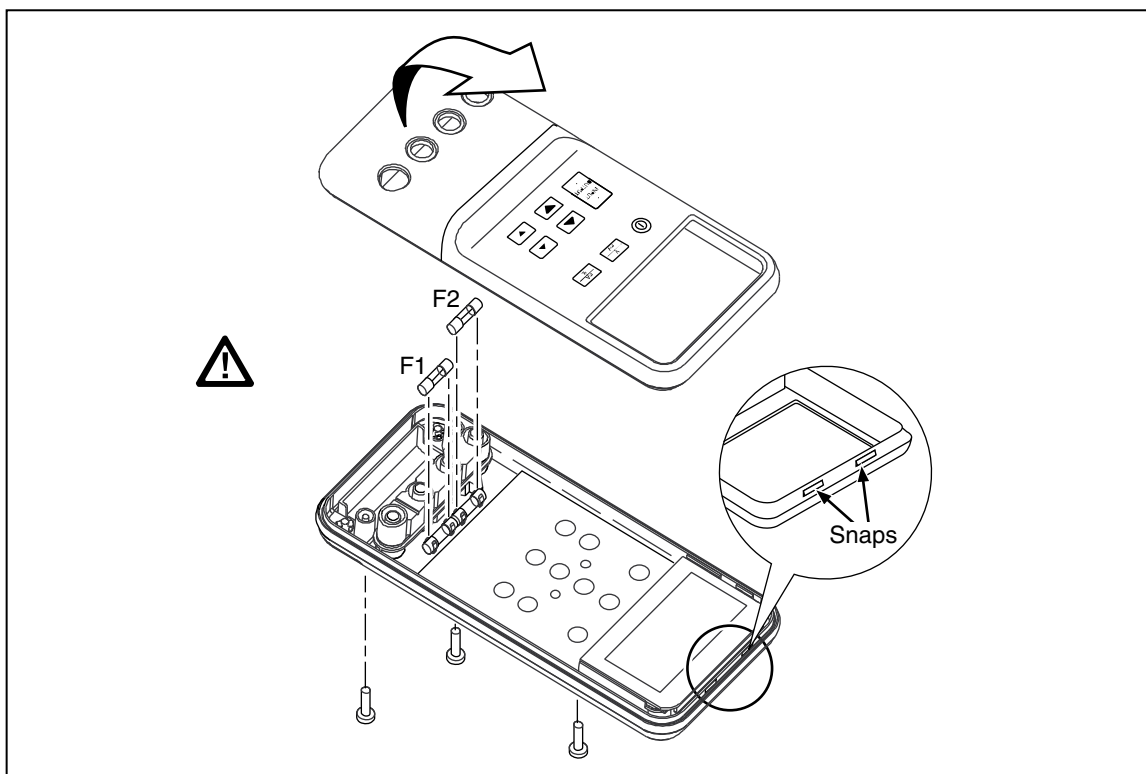

**Figure 5. Replacing the Fuses (715 shown)**

it08f.emf

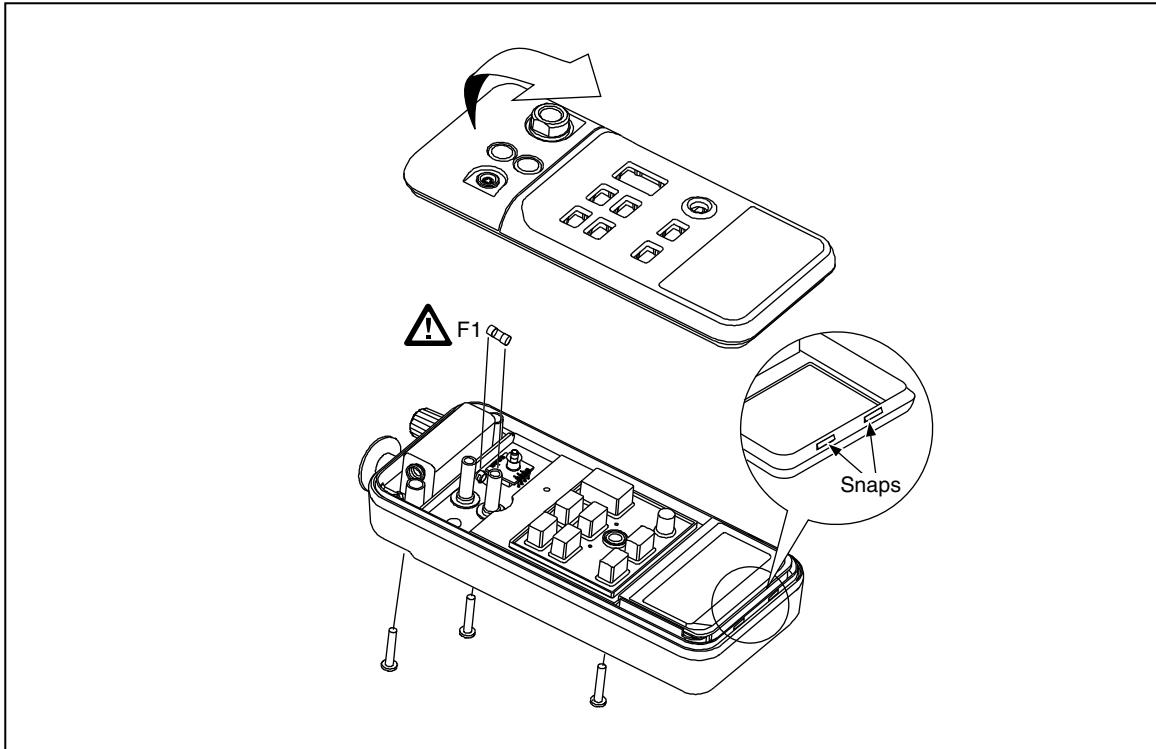

Figure 6. Replacing the Fuse (718 shown)

Wh003f.emf

## Required Equipment

The equipment required to perform the verification and calibration procedures in this manual is identified in Table 33.

Table 33. Required Calibration Equipment

Calibrator Model	Equipment	Minimum Specifications	Recommended Model
712	DC Calibrator	5 to 3000 $\Omega$ Accuracy: 70 ppm + 0.025 $\Omega$	Fluke 5520A
	Reference Multimeter	5 to 3000 $\Omega$ Accuracy: 70 ppm + 0.037 $\Omega$	Fluke 8508A
	Four Test Leads		5500A/LEADS

**Table 33. Required Calibration Equipment (cont.)**

Calibrator Model	Equipment	Minimum Specifications	Recommended Model
714	DC Calibrator	-10 to 75 mV Accuracy: 0.006 % + 0.25 mV	Fluke 5520A
	Reference Multimeter	-10 to 75 mV Accuracy: 0.006 % + 0.25 mV	Fluke 8508A
	TC to Banana Test Leads	Copper Mini-Jack to Copper Wire	
	Type J TC Test Lead		5500A/LEADS
715	DC Calibrator	0 to 10 Volts Accuracy: 0.005 % + 0.5 mV	Fluke 5520A
	Reference Multimeter	0 to 10 Volts Accuracy: 0.005 % + 0.5 mV	Fluke 8508A
	Two Test Leads		
717	DC Calibrator	0 to 24 mA	Fluke 5520A
	Reference Multimeter	0 to 24 mA Accuracy: 0.006 % + 0.25 mA	Fluke 8508A
	Dead Weight Tester	-12 to 10000 PSIG Accuracy: 0.006 % of range	
	Two Test Leads		5500A/LEADS
	700P Pressure Module		
	Load Resistors	1 k $\Omega$ and 2 k $\Omega$ 10% 0.5W	
718/718Ex	DC Calibrator	0 to 24 mA	Fluke 5520A
	Reference Multimeter	0 to 24 mA Accuracy: 0.006 % + 0.25 mA	Fluke 8508A
	Dead Weight Tester	-12 to 300 PSIG Accuracy: 0.006 % of range	
	Two Test Leads		5500A/LEADS
	700P Pressure Module		
	Load Resistors	1 k $\Omega$ and 2 k $\Omega$ 10% 0.5 W	
719	DC Calibrator	0 to 24 mA	Fluke 5520A
	Reference Multimeter	0 to 24 mA Accuracy: 0.006 % + 0.25 mA	Fluke 8508A
	Dead Weight Tester	-12 to 100 PSIG Accuracy: 0.006 % of range	DHI PPC3
	Two Test Leads		5500A/LEADS
	700P Pressure Module		
	Load Resistors	1.2 k $\Omega$ and 10% 0.5 W	

## Verification

The following verification tests check the accuracy of each Calibrator function against the Calibrator's specifications. If the Calibrator fails any of these tests, calibration adjustment or repair is required. Fluke recommends that you calibrate your 71X Calibrator once a year to ensure that it performs according to its specifications.

To perform the verification tests, it is not necessary to open the case or adjust the Calibrator. Simply make the required connections, apply the designated source stimulus and determine if the measurements fall within the acceptable range indicated.

### Note

*Throughout this section, the 71X Calibrator may be referred to as the "UUT" (unit under test). Later 71x Calibrators use automatic shutdown to preserve the batteries. When turned on, the displays will show **PS** followed by a number. The number designates minutes until shutdown. If the number is less than 10, use the arrow keys to set to 15 minutes or more.*



### Preparing for Verification

To prepare for verification, do the following:

1. Make sure fuse(s) in the UUT are intact. By referring to Table 32, you should not have to open the unit.
2. Make sure you have the required test equipment available. (Refer to Table 33.)
3. Turn on and warm up the test equipment for the time required.
4. Allow UUT to come to ambient temperature. Turn it on and allow 5 minutes for warm-up of the UUT.

### 712 Verification (V1.1 and Earlier)

#### Resistance Measure Verification

1. Push the green  key to turn on the 712. Push the  key, the  key, so that the display indicates:

INPUT TYPE R 4W

2. Configure the 712 Calibrator into a 4-wire ohms measurement:
  - Connect two test leads from the NORMAL jacks of the 5520A to the INPUT jacks (two middle jacks) on the 712 Calibrator (black to black, red to red).
  - Connect two additional test leads, also from the NORMAL jacks of the 5520A, to the 712 Calibrator (black wire to the 712 red jack labeled [3W NC] and red wire to the red jack labeled [4W NC]). All four input jacks of the 712 should now be configured in a 4-wire ohms measurement.
3. Set the Fluke 5520A to the settings in Table 34, and verify the reading as displayed on the 712 Calibrator:

**Table 34. 712 Resistance Measure Verification**





Fluke 5520A	Fluke 712
207.5 $\Omega$	207.4 to 207.6 $\Omega$
950.0 $\Omega$	949.5 to 950.5 $\Omega$
2350.0 $\Omega$	2349.0 to 2351.0 $\Omega$

4. Disconnect the test leads.

### Resistance Source Verification

1. Using four test leads, connect the four jacks of Fluke 8508A ( $\Omega$  Sense 'Hi & Lo' and Input 'Hi & Lo') to the two middle jacks of the 712 Calibrator (black to black; red to red). This puts the Fluke 8508A in a 4-wire configuration.
2. On the Fluke 8508A, select four-wire ohms measurement and up-range to the 1 k $\Omega$  range. Use the 1 k $\Omega$  range for the first test point and use the 10 k $\Omega$  range for the last two test points. Correct ranging is important in supplying the correct excitation current back into the 712 Calibrator. Otherwise the specifications may change, or the measurements may be incorrect.
3. Push the  key on the 712 Calibrator so that the display indicates:





OUTPUT

Using the large (, ), and small (, ), scroll keys, source the resistance settings in Table 35, verifying the readings on the Fluke 8508A display:



**Table 35. 712 Resistance Source Verification**

Fluke 712	Fluke 8508A
207.5 $\Omega$	.2074 to .2076 k $\Omega$
950.0 $\Omega$	.9495 to .9505 k $\Omega$
2350.0 $\Omega$	2.349 to 2.351 k $\Omega$

### Keypad Test



1. Push and hold the large  to source 950.0  $\Omega$ .
2. Push and hold the small  scroll key. Verify the numbers scrolling on the display changes in 0.1 increments, then changes in 1.0 increments, then in 10.0 increments.
3. Push and hold the small  scroll key. Verify the numbers scrolling on the display changes in 0.1 decrements, then changes in 1.0 decrements, then in 10.0 decrements.
4. Disconnect all test leads from the 712 Calibrator and push the  key to turn the Calibrator off.

### Display Verification

1. Push and hold the  key and then turn the 712 back on by pressing and releasing the green  key. This locks the 712 in a mode where all display segments are on. All segments will stay on until the  key is released.
2. Check to see that all segments of the LCD are displayed.
3. Turn the 712 off.



The 712 verification test is complete.

**712 Verification (V1.2 through V1.9)**

1. Push  button until Input comes up on the display.
2. Push  until PT100 392 JIS is on the display.
3. Push  until 4W is on the display. Set temperature standard to C.
4. Set the 5520A to 2-wire output with 2-wire compensation turned off; then make 2-wire connections on the 5520A to 4-wire connections on the 712. Set the 5520A to PT 3916 (ITS-90) mode.
5. Set the 5520A to output the RTD (resistance) values in Table 36. Verify that the temperature readings are within the limits shown for 4-wire UUT.

**Table 36. 712 Verification RTD Values**

5520A Outputs (C)	3-wire 712 Readings (C)	4-wire 712 Readings (C)
-180 (25.799 Ω)	-179.5 to -180.5	-179.7 to -180.3
100 (139.171 Ω)	99.5 to 100.5	99.7 to 100.3
550 (300.822 Ω)	549.5 to 550.5	549.7 to 550.3

6. Remove the 4-wire connection on the 712 (rightmost connection). Push  once and verify that 3W is on the display and that the temperature readings are within the limits shown for 3-wire readings. Push  to return to 4W mode.
7. Restore the 4-wire connection to the 712 and maintain 2-wire connection on the 5520A.
8. Push  until Ω is displayed.
9. Set the 5520A to source resistance, to a 2-wire output, with 2-wire compensation turned off.
10. Set the 5520A to source the resistance values in Table 37. Verify that the resistance values on the 712 are within the limits shown.

**Table 37. 712 Verification Resistance Values**

5520A Outputs (Ω)	4-wire 712 Readings (Ω)
5.00	4.90 to 5.10
300.00	299.90 to 300.10
1500.0	1499.5 to 1500.5
3000.0	2999.0 to 3001.0

11. Make 2-wire connections on the 712 to 4-wire connections on the Fluke 8508A . Set the Fluke 8508A to measure 4-wire resistance.
12. Push  until OUTPUT is displayed.
13. Set the 712 to output the resistance values in Table 38. Verify that the Fluke 8508A readings are within the limits shown.



Table 38. 712 Verification Outputs

712 Outputs (Ohms)	Fluke 8508A Readings (Ohms)
5.00	4.90 to 5.10
300.00	299.90 to 300.10
1500.0	1499.5 to 1500.5
3000.0	2999.0 to 3001.0

14. Disconnect all connections to the 712. The 712 verification test is complete.

**712 Verification (V2.0 and Later)**







1. Push  button until Input comes up on the display.
2. Push  until PT100 392 JIS is on the display.
3. Push  until 4W is on the display. Set temperature standard to C.
4. Set the 5520A to 2-wire output with 2-wire compensation turned off; then make 2-wire connections on the 5520A to 4-wire connections on the 712. Set the 5520A to PT 3916 (ITS-90) mode.
5. Set the 5520A to output the RTD (resistance) values in Table 39. Verify that the temperature readings are within the limits shown for 4-wire UUT.

Table 39. 712 Verification RTD Values

5520A Outputs (C)	3-wire 712 Readings (C)	4-wire 712 Readings (C)
-180 (25.799 Ω)	-179.72 to -180.28	-179.8 to -180.2
100 (139.171 Ω)	99.6 to 100.4	99.7 to 100.3
300 (213.957 Ω)	299.7 to 300.3	299.6 to 300.4
550 (300.822 Ω)	549.48 to 550.52	549.6 to 550.4

6. Remove the 4-wire connection on the 712 (rightmost connection). Push  once and verify that 3W is on the display and that the temperature readings are within the limits shown for 3-wire readings. Push  to return to 4W mode.
7. Restore the 4-wire connection to the 712 and maintain 2-wire connection on the 5520A.
8. Push  until Ω is displayed.
9. Set the 5520A to source resistance, to a 2-wire output, with 2-wire compensation turned off.
10. Set the 5520A to source the resistance values in Table 40. Verify that the resistance values on the 712 are within the limits shown.

**Table 40. 712 Verification Resistance Values**

5520A Outputs ( $\Omega$ )	4-wire 712 Readings ( $\Omega$ )
5.00	4.899 to 5.101
300.00	299.825 to 300.175
1500.0	1499.525 to 1500.475
30000.0	2999.15 to 3000.85

11. Make 2-wire connections on the 712 to 4-wire connections on the Fluke 8508A. Set the Fluke 8508A to measure 4-wire resistance.
12. Push  until OUTPUT is displayed.
13. Set the 712 to output the resistance values in Table 41. Verify that the Fluke 8508A readings are within the limits shown.

**Table 41. 712 Verification Outputs**

712 Outputs (Ohms)	Fluke 8508A Readings (Ohms)
5.00	4.899 to 5.101
300.00	299.825 to 300.175
1500.0	1499.525 to 1500.475
30000.0	2999.15 to 3000.85

14. Disconnect all connections to the 712. The 712 verification test is complete.

**714 Verification (Earlier than V2.0)**

**Thermocouple Measure Verification**

1. Push the  key to turn on the 714 Calibrator. Push the  key and the  key so that the display indicates:  
 INPUT    xx.x °C  
 where xx.x is some variable number; or OL (overload) may be indicated.
2. Push the  key to measure Type J thermocouple and connect the Type J thermocouple test lead from the TC jack of the Fluke 5520A to the TC jack on the 714 Calibrator, observing correct polarity.
3. Set the Fluke 5520A to output in Type J thermocouple, push the  key, and set the 5520A to the settings in Table 42, verifying the display readings on the 714:

**Table 42. 714 Thermocouple Measure Verification**

Fluke 5520A	Fluke 714
-200.00 °C	-200.9 °C to -199.1 °C
0.00 °C	-0.7 °C to +0.7 °C
1200.00 °C	1199.3 °C to 1200.7 °C

4. Disconnect the Type J thermocouple test lead and install the two-wire copper test lead from the Fluke 5520A NORMAL jacks to the 714 Calibrator TC jack, observing correct polarity.

5. On the 714 push the  key until "mV" is shown on the display.
6. Set the Fluke 5520A to the settings in Table 43 and verify the display readings on the 714 Calibrator.



**Table 43. 714 Thermocouple Measure Verification (mA)**

Fluke 5520A	Fluke 714
-10.0000 mV	-10.03 to -9.97 mV
30.0000 mV	29.97 to 30.03 mV
75.0000 mV	74.97 to 75.03 mV

7. Disconnect the copper test lead from the Fluke 5520A.





**Thermocouple Source Verification**

1. Set the Fluke 8508A to VDC and 200 mV range. Connect the two-wire copper test lead from the TC jack on the 714 Calibrator to the INPUT jacks of the Fluke 8508A.
2. Push the  key on the 714 Calibrator to indicate:  

OUTPUT    0.00 mV
3. On the 714, push the large  and  scroll keys to source the voltages in Table 44 while verifying the readings on the Fluke 8508A.

**Table 44. 714 Thermocouple Source Verification (mA)**





Fluke 714	Fluke 8508A
-10.00 mV	-10.028 to -9.972 mV
30.00 mV	29.972 to 30.028 mV
75.00 mV	74.972 to 75.028 mV

4. Push the  key on the 714 Calibrator to TYPE J and disconnect the copper wire test lead.
5. Connect the Type J thermocouple test lead from the Fluke 5520A TC jack to the TC jack on the 714 Calibrator, observing correct polarity.
6. Set the Fluke 5520A to  with 'Type J' input. On the 714, push the large  and  scroll keys to source the temperatures in Table 45 while verifying the readings on the 5520A:

**Table 45. 714 Thermocouple Source Verification (Temperature)**



Fluke 714	Fluke 5520A
0.0 °C	-0.70 °C to +0.70 °C
-200.0 °C	-200.94 °C to -199.06 °C
1200 °C	1199.33 °C to 1200.67 °C

### Keypad Test

1. On the 714 Calibrator, push the large  scroll key to 800.0 °C.
2. Push and hold the small  scroll key, verifying that the numbers scrolling on the display change in 0.1 increments, then change in 1.0 increments, then change in 10.0 increments.
3. Push and hold the  scroll key, verifying that the numbers scrolling on the display change in 0.1 decrements, then change in 1.0 decrements, then change in 10.0 decrements.
4. Scroll to 800.0 °C.
5. Push the  key on the 714 Calibrator. The display should change to:  

OUTPUT    1472.0 °F
6. Disconnect the Type J test lead from the 714 Calibrator and push the  key to turn the Calibrator off.



### Display Verification

1. Push and hold the  key and then push and release the green  key. This locks the 714 in a mode where all display segments are on. All segments will stay on until the  key is released.
2. Check to see that all segments of the display are showing.
3. Turn the 714 off.



The 714 verification test is now complete.

### 714 Verification (V2.0 and Later)

#### Thermocouple Measure Verification

1. Push the  key to turn on the 714 Calibrator. Push the  key and the  key so that the display indicates:  

INPUT        xx.x °C

where xx.x is some variable number; or OL (overload) may be indicated.
2. Push the  key to measure Type J thermocouple and connect the Type J thermocouple test lead from the TC jack of the Fluke 5520A to the TC jack on the 714 Calibrator, observing correct polarity.
3. Set the Fluke 5520A to output in Type J thermocouple, push the  key, and set the 5520A to the settings in Table 46, verifying the display readings on the 714:

**Table 46. 714 Thermocouple Measure Verification**

Fluke 5520A	Fluke 714
-200.00 °C	-200.6 °C to -199.4 °C
0.00 °C	-0.4 °C to +0.4 °C
800.00 °C	799.6 °C to 800.4 °C
1200.00 °C	1199.5 °C to 1200.5 °C

7. Disconnect the Type J thermocouple test lead and install the two-wire copper test lead from the Fluke 5520A NORMAL jacks to the 714 Calibrator TC jack, observing correct polarity.

8. On the 714 push the  key until "mV" is shown on the display.
9. Set the Fluke 5520A to the settings in Table 47 and verify the display readings on the 714 Calibrator.



**Table 47. 714 Thermocouple Measure Verification (mV)**

Fluke 5520A	Fluke 714
-10.0000 mV	-10.012 mV to -9.988 mV
30.0000 mV	29.985 to 30.015 mV
75.0000 mV	74.979 mV to 75.021 mV

10. Disconnect the copper test lead from the Fluke 5520A.





**Thermocouple Source Verification**

1. Set the Fluke 8508A to VDC and 200 mV range. Connect the two-wire copper test lead from the TC jack on the 714 Calibrator to the INPUT jacks of the Fluke 8508A.
2. Push the  key on the 714 Calibrator to indicate:  

OUPUT     0.00 mV
3. On the 714, push the large  and  scroll keys to source the voltages in Table 48 while verifying the readings on the Fluke 8508A.

**Table 48. 714 Thermocouple Source Verification (mV)**

Fluke 714	Fluke 8508A
-10.00 mV	-10.015 mV to -9.9885 mV
30.00 mV	29.9855 mV to 30.0145 mV
75.00 mV	74.97875 mV to 75.02125 mV

4. Push the  key on the 714 Calibrator to TYPE J and disconnect the copper wire test lead.
5. Connect the Type J thermocouple test lead from the Fluke 5520A TC jack to the TC jack on the 714 Calibrator, observing correct polarity.
6. Set the Fluke 5520A to  with 'Type J' input. On the 714, push the large  and  scroll keys to source the temperatures in Table 49 while verifying the readings on the 5520A:



**Table 49. 714 Thermocouple Source Verification (Temperature)**

Fluke 714	Fluke 5520A
-200.0 °C	-200.6 °C to -199.4 °C
0.0 °C	-0.4 °C to +0.4 °C
800.00 °C	799.6 °C to 800.4 °C
1200 °C	1199.5 °C to 1200.5 °C

The 714 verification test is now complete.

**715 Verification (Earlier than V2.0)**

**DC Voltage Source Verification**

1. On the 715 Calibrator turn the green  key on.
2. Push the  and the  key so that the display indicates:  

OUTPUT 0.000 V
3. Connect test leads from the Fluke 8508A input HI & LO jacks to the voltage jacks on the 715 Calibrator (black to COM and red to V).
4. Using the large  scroll button of the 715 Calibrator, push to step to the voltages in Table 50, verifying the output on the Fluke 8508A:

**Table 50. 715 DC Voltage Source Verification (0.000 to 10.000 V)**

Fluke 715	Fluke 8508A
0.000 V	-0.002 V to + 0.002 V
5.000 V	4.997 V to 5.003 V
10.000 V	9.996 V to 10.004 V

5. Push the  key on the 715 Calibrator. Display should change to:  

OUTPUT 0.00 mV
6. Using the large  key scroll button of the 715 Calibrator, push to step to the voltages in Table 51, verifying the output on the Fluke 8508A.

**Table 51. 715 DC Voltage Source Verification (0.00 to 100.00 V)**

Fluke 715	Fluke 8508A
0.00 mV	-0.02 mV to + 0.02 mV
50.00 mV	49.97 mV to 50.03 mV
100.00 mV	99.96 mV to 100.04 mV

**DC Current Source Verification**





1. Disconnect the Fluke 8508A. Push the  key on the 715 Calibrator. The display should change to:  

OUTPUT 0.000 mA
2. Connect test leads from the 715 Calibrator's mA output jacks (black to V jack and red to +LOOP jack) to the Fluke 8508A input mA jacks (black to I- and red to I+).
3. Set the Fluke 8508A function to [DC CURRENT]. Using the large  scroll button of the 715 Calibrator, push to step to the current outputs in Table 52, verifying the readings on the Fluke 8508A.

**Table 52. 715 DC Current Source Verification**



Fluke 715	Fluke 8508A
4.000 mA	3.9972 mA to 4.0028 mA
12.000 mA	11.9956 mA to 12.0044 mA
24.000 mA	23.9932 mA to 24.0068 mA

**Keypad Test**

1. Using the large  scroll key, push to step down to 12.000 mA.
2. Using the small  scroll key, push to verify that the numbers scrolling on the display change in .001 increments; then change in .01 increments; then change in 0.1 increments.
3. Using the small  scroll key, push to verify that the numbers scrolling on the display change in .001 decrements; then change in .01 decrements; then change in 0.1 decrements.
4. Scroll to 12.000 mA.
5. Push the  key on the 715 Calibrator. Display should change to:

OUTPUT 50.00 mA %

**DC Current Measure Verification**

1. Push the  key on the 715 Calibrator. Display should indicate closely to:  
INPUT -25.00 mA %
2. Push the  key and the display should change to:  
INPUT 0.000 mA
3. Connect a test lead from Red AUX terminal of the 5520A to the Fluke 8508A I+ terminal.
4. Connect a test lead from Black AUX terminal of the 5520A to the 715 Calibrator Com terminal.
5. Connect a test lead from I- terminal of the Fluke 8508A to the 715 Calibrator mA terminal.
6. Adjust the 5520A if necessary, so that the current shown on the Fluke 8508A is the same as the 5520A values shown in Table 53.
7. Verify that the display readings on the 715 Calibrator are within the limits.

**Table 53. 715 DC Current Measure Verification**

Fluke 5520A	Fluke 715
24.0000 mA	23.993 mA to 24.007 mA
12.0000 mA	11.996 mA to 12.004 mA
4.0000 mA	3.998 mA to 4.002 mA

**DC Voltage Measure Verification**

1. Push the  key on the 715 Calibrator. Display should change to:  
INPUT 0.000 V
2. Connect test leads from the output *NORMAL* jacks of the Fluke 5520A to the voltage jacks on the 715 Calibrator (black to *COM* jack and red to the *V* jack).
3. Set the Fluke 5520A for the voltage settings in Table 54 and verify the display readings on the 715 Calibrator.

**Table 54. 715 DC Voltage Measure Verification (10.0000 to 0.0000 V)**

Fluke 5520A	Fluke 715
10.00000 V	9.996 V to 10.004 V
5.00000 V	4.997 V to 5.003 V
0.0000 V	-0.002 V to +0.002 V



4. Push the  key on the 715 Calibrator. Display should indicate closely to:  
INPUT 0.00 mV
5. Set the Fluke 5520A for the mV settings in Table 55 and verify display readings on the 715 Calibrator.

**Table 55. 715 DC Voltage Measure Verification (0.0000 mV to 100.0000 mV)**

Fluke 5520A	Fluke 715
0.0000 mV	-0.02 mV to + 0.02 mV
50.0000 mV	49.97 mV to 50.03 mV
100.0000 mV	99.96 mV to 100.04 mV

6. Disconnect the test leads from 715 Calibrator and turn the green  key off.

**Display Verification**



1. Push and hold the  key and then turn the 715 back on by pressing and releasing the green  key. This locks the 715 in a mode where all display segments are on. All segments will stay on until the  key is released.
2. Check to see that all segments of the LCD are displayed.
3. Turn the 715 off.

The 715 verification test is complete.



## 715 Verification (V2.0 and Later)

### DC Voltage Source Verification

1. On the 715 Calibrator turn the green  key on.
2. Push the  and the  key so that the display indicates:  

OUTPUT    0.000 V
3. Connect test leads from the Fluke 8508A input HI & LO jacks to the voltage jacks on the 715 Calibrator (black to COM and red to V).
4. Using the large  scroll button of the 715 Calibrator, push to step to the voltages in Table 56, verifying the output on the Fluke 8508A:

**Table 56. 715 DC Voltage Source Verification (0.000 to 20.000 V)**

Fluke 715	Fluke 8508A
0.000 V	-0.002 V to + 0.002 V
5.000 V	4.998 V to 5.002 V
15.000 V	14.997 V to 15.003 V

5. Push the  key on the 715 Calibrator. Display should change to:  

OUTPUT    0.00 mV
6. Using the large  key scroll button of the 715 Calibrator, push to step to the voltages in Table 57, verifying the output on the Fluke 8508A.

**Table 57. 715 DC Voltage Source Verification (0.00 to 200.00 mV)**

Fluke 715	Fluke 8508A
0.00 mV	-0.02 mV to + 0.02 mV
50.00 mV	49.98 mV to 50.02 mV
150.00 mV	149.96 mV to 150.04 mV

### DC Current Source Verification



1. Disconnect the Fluke 8508A. Push the  key on the 715 Calibrator. The display should change to:  

OUTPUT    0.000 mA
2. Connect test leads from the 715 Calibrator's mA output jacks (black to V jack and red to +LOOP jack) to the Fluke 8508A input mA jacks (black to I- and red to I+).
3. Set the Fluke 8508A function to [DC CURRENT]. Using the large  scroll button of the 715 Calibrator, push to step to the current outputs in Table 58, verifying the readings on the Fluke 8508A.

**Table 58. 715 DC Current Source Verification**

Fluke 715	Fluke 8508A
4.000 mA	3.9976 mA to 4.0024 mA
12.000 mA	11.9968 mA to 12.0032 mA
24.000 mA	23.9956 mA to 24.0044 mA

**DC Current Measure Verification**

1. Push the  key on the 715 Calibrator. Display should indicate closely to:  
INPUT -25.00 mA %
2. Push the  key and the display should change to:  
INPUT 0.000 mA
3. Connect a test lead from Red AUX terminal of the 5520A to the Fluke 8508A I+ terminal.
4. Connect a test lead from Black AUX terminal of the 5520A to the 715 Calibrator Com terminal.
5. Connect a test lead from I- terminal of the Fluke 8508A to the 715 Calibrator mA terminal.
6. Adjust the 5520A if necessary so that the current shown on the Fluke 8508A is the same as the 5520A values shown in Table 59.
7. Verify that the display readings on the 715 Calibrator are within the limits.

**Table 59. 715 DC Current Measure Verification**

Fluke 5520A	Fluke 715
24.0000 mA	23.993 mA to 24.007 mA
12.0000 mA	11.996 mA to 12.004 mA
4.0000 mA	3.998 mA to 4.002 mA

**DC Voltage Measure Verification**

1. Push the  key on the 715 Calibrator. Display should change to:  
INPUT 0.000 V
2. Connect test leads from the output *NORMAL* jacks of the Fluke 5520A to the voltage jacks on the 715 Calibrator (black to *COM* jack and red to the *V* jack).
3. Set the Fluke 5520A for the voltage settings in Table 60 and verify the display readings on the 715 Calibrator.

**Table 60. 715 DC Voltage Measure Verification (25.0000 to 0.0000 V)**

Fluke 5520A	Fluke 715
20.00000 V	19.996 V to 20.004 V
10.00000 V	9.997 V to 10.003 V
0.0000 V	-0.002 V to +0.002 V

4. Push the  key on the 715 Calibrator. Display should indicate closely to:  
INPUT 0.00 mV
5. Set the Fluke 5520A for the mV settings in Table 61 and verify display readings on the 715 Calibrator.

**Table 61. 715 DC Voltage Measure Verification (0.0000 mV to 200.0000 mV)**

Fluke 5520A	Fluke 715
0.0000 mV	-0.02 mV to + 0.02 mV
50.0000 mV	49.98 mV to 50.02 mV
150.0000 mV	149.96 mV to 150.04 mV

6. Disconnect the test leads from 715 Calibrator and turn the green Ⓞ key off.

The 715 verification test is complete.

### 717 Verification

#### Pressure Verification

1. Carefully attach the pressure fitting of the deadweight tester to the pressure port of the 717 30G Calibrator.

*Note*

*Use Plenty of TEFLON tape when attaching pressure fitting.*

The display should read 0.00 PSI with the deadweight tester opened up to ambient air. If not, push the ZERO key until display reads 0.00 PSI.

2. Set up the deadweight tester for the sequence of PSI inputs from Table 62 to be injected into the pressure port of the 717 Calibrator.

*Note*

*In Table 62, Vacuum is only specified for V1.3 and later. To display the firmware version:*

1. Turn off the 717.
2. Push and hold the center bottom button as you push Ⓞ to turn power on.
3. Ensure the pressure has stabilized at each input before verifying the display reading.

**Table 62. 717 Pressure Verification**

717 1G, 2 Range						
	<V3.9	<V3.9	>V4 1 Yr	>V4 1 Yr	>V4 6 Mo	>V4 6 Mo
Applied	Lower Limit	Upper Limit	Lower Limit	Upper Limit	Lower Limit	Upper Limit
0.0000 PSI	-0.0010 PSI	0.0010 PSI	-0.0010 PSI	0.0010 PSI	-0.0010 PSI	0.0010 PSI
0.1000 PSI	0.0990 PSI	0.1010 PSI	0.0990 PSI	0.1010 PSI	0.0990 PSI	0.1010 PSI
0.2000 PSI	0.1990 PSI	0.2010 PSI	0.1990 PSI	0.2010 PSI	0.1990 PSI	0.2010 PSI
0.3000 PSI	0.2990 PSI	0.3010 PSI	0.2990 PSI	0.3010 PSI	0.2990 PSI	0.3010 PSI
0.4000 PSI	0.3990 PSI	0.4010 PSI	0.3990 PSI	0.4010 PSI	0.3990 PSI	0.4010 PSI
0.5000 PSI	0.4990 PSI	0.5010 PSI	0.4990 PSI	0.5010 PSI	0.4990 PSI	0.5010 PSI
0.6000 PSI	0.5990 PSI	0.6010 PSI	0.5990 PSI	0.6010 PSI	0.5990 PSI	0.6010 PSI
0.7000 PSI	0.6990 PSI	0.7010 PSI	0.6990 PSI	0.7010 PSI	0.6990 PSI	0.7010 PSI
0.8000 PSI	0.7990 PSI	0.8010 PSI	0.7990 PSI	0.8010 PSI	0.7990 PSI	0.8010 PSI
0.9000 PSI	0.8990 PSI	0.9010 PSI	0.8990 PSI	0.9010 PSI	0.8990 PSI	0.9010 PSI
1.0000 PSI	0.9990 PSI	1.0010 PSI	0.9990 PSI	1.0010 PSI	0.9990 PSI	1.0010 PSI
-0.2000 PSI	-0.2010 PSI	-0.1990 PSI	-0.2010 PSI	-0.1990 PSI	-0.2010 PSI	-0.1990 PSI
-0.4000 PSI	-0.4010 PSI	-0.3990 PSI	-0.4010 PSI	-0.3990 PSI	-0.4010 PSI	-0.3990 PSI
-0.6000 PSI	-0.6010 PSI	-0.5990 PSI	-0.6010 PSI	-0.5990 PSI	-0.6010 PSI	-0.5990 PSI
-0.8000 PSI	-0.8010 PSI	-0.7990 PSI	-0.8010 PSI	-0.7990 PSI	-0.8010 PSI	-0.7990 PSI
-1.0000 PSI	-1.0010 PSI	-0.9990 PSI	-1.0010 PSI	-0.9990 PSI	-1.0010 PSI	-0.9990 PSI
717 15G, 27 Range						
	1 Yr	1 Yr	6 Mo	6 Mo		
Applied	Lower Limit	Upper Limit	Lower Limit	Upper Limit		
0.000 PSI	-0.009 PSI	0.009 PSI	-0.007 PSI	0.007 PSI		
3.000 PSI	2.991 PSI	3.009 PSI	2.993 PSI	3.007 PSI		
6.000 PSI	5.991 PSI	6.009 PSI	5.993 PSI	6.007 PSI		
9.000 PSI	8.991 PSI	9.009 PSI	8.993 PSI	9.007 PSI		
12.000 PSI	11.991 PSI	12.009 PSI	11.993 PSI	12.007 PSI		
15.000 PSI	14.991 PSI	15.009 PSI	14.993 PSI	15.007 PSI		
12.000 PSI	11.991 PSI	12.009 PSI	11.993 PSI	12.007 PSI		
9.000 PSI	8.991 PSI	9.009 PSI	8.993 PSI	9.007 PSI		
6.000 PSI	5.991 PSI	6.009 PSI	5.993 PSI	6.007 PSI		
3.000 PSI	2.991 PSI	3.009 PSI	2.993 PSI	3.007 PSI		
-6.000 PSI	-6.009 PSI	-5.991 PSI	-6.007 PSI	-5.993 PSI		
-12.000 PSI	-12.009 PSI	-11.991 PSI	-12.007 PSI	-11.993 PSI		

**Table 62. 717 Pressure Verification (cont.)**

<b>717 30G, 30 Range</b>						
	<b>&lt;V1.2</b>	<b>&lt;V1.2</b>				
<b>Applied</b>	<b>Lower Limit</b>	<b>Upper Limit</b>				
0.000 PSI	-0.015 PSI	0.015 PSI				
6.000 PSI	5.985 PSI	6.015 PSI				
12.000 PSI	11.985 PSI	12.015 PSI				
18.000 PSI	17.985 PSI	18.015 PSI				
24.000 PSI	23.985 PSI	24.015 PSI				
30.000 PSI	29.985 PSI	30.015 PSI				
24.000 PSI	23.985 PSI	24.015 PSI				
18.000 PSI	17.985 PSI	18.015 PSI				
12.000 PSI	11.985 PSI	12.015 PSI				
6.000 PSI	5.985 PSI	6.015 PSI				
<b>717 30G, 42 Range</b>						
	<b>&lt;V3.9</b>	<b>&lt;V3.9</b>	<b>&gt;V4 1 Yr</b>	<b>&gt;V4 1 Yr</b>	<b>&gt;V4 6 Mo</b>	<b>&gt;V4 6 Mo</b>
<b>Applied</b>	<b>Lower Limit</b>	<b>Upper Limit</b>	<b>Lower Limit</b>	<b>Upper Limit</b>	<b>Lower Limit</b>	<b>Upper Limit</b>
0.000 PSI	-0.021 PSI	0.021 PSI	-0.015 PSI	0.015 PSI	-0.011 PSI	0.011 PSI
6.000 PSI	5.979 PSI	6.021 PSI	5.985 PSI	6.015 PSI	5.989 PSI	6.011 PSI
12.000 PSI	11.979 PSI	12.021 PSI	11.985 PSI	12.015 PSI	11.989 PSI	12.011 PSI
18.000 PSI	17.979 PSI	18.021 PSI	17.985 PSI	18.015 PSI	17.989 PSI	18.011 PSI
24.000 PSI	23.979 PSI	24.021 PSI	23.985 PSI	24.015 PSI	23.989 PSI	24.011 PSI
30.000 PSI	29.979 PSI	30.021 PSI	29.985 PSI	30.015 PSI	29.989 PSI	30.011 PSI
24.000 PSI	23.979 PSI	24.021 PSI	23.985 PSI	24.015 PSI	23.989 PSI	24.011 PSI
18.000 PSI	17.979 PSI	18.021 PSI	17.985 PSI	18.015 PSI	17.989 PSI	18.011 PSI
12.000 PSI	11.979 PSI	12.021 PSI	11.985 PSI	12.015 PSI	11.989 PSI	12.011 PSI
6.000 PSI	5.979 PSI	6.021 PSI	5.985 PSI	6.015 PSI	5.989 PSI	6.011 PSI
-12.000 PSI	-12.021 PSI	-11.979 PSI	-12.015 PSI	-11.985 PSI	-12.011 PSI	-11.989 PSI

**Table 62. 717 Pressure Verification (cont.)**

<b>717 100G, 112 Range</b>						
	<b>&lt;V3.9</b>	<b>&lt;V3.9</b>	<b>&gt;V4 1 Yr</b>	<b>&gt;V4 1 Yr</b>	<b>&gt;V4 6 Mo</b>	<b>&gt;V4 6 Mo</b>
<b>Applied</b>	<b>Lower Limit</b>	<b>Upper Limit</b>	<b>Lower Limit</b>	<b>Upper Limit</b>	<b>Lower Limit</b>	<b>Upper Limit</b>
0.00 PSI	-0.06 PSI	0.06 PSI	-0.04 PSI	0.04 PSI	-0.03 PSI	0.03 PSI
20.00 PSI	19.94 PSI	20.06 PSI	19.96 PSI	20.04 PSI	19.97 PSI	20.03 PSI
40.00 PSI	39.94 PSI	40.06 PSI	39.96 PSI	40.04 PSI	39.97 PSI	40.03 PSI
60.00 PSI	59.94 PSI	60.06 PSI	59.96 PSI	60.04 PSI	59.97 PSI	60.03 PSI
80.00 PSI	79.94 PSI	80.06 PSI	79.96 PSI	80.04 PSI	79.97 PSI	80.03 PSI
100.00 PSI	99.94 PSI	100.06 PSI	99.96 PSI	100.04 PSI	99.97 PSI	100.03 PSI
80.00 PSI	79.94 PSI	80.06 PSI	79.96 PSI	80.04 PSI	79.97 PSI	80.03 PSI
60.00 PSI	59.94 PSI	60.06 PSI	59.96 PSI	60.04 PSI	59.97 PSI	60.03 PSI
40.00 PSI	39.94 PSI	40.06 PSI	39.96 PSI	40.04 PSI	39.97 PSI	40.03 PSI
20.00 PSI	19.94 PSI	20.06 PSI	19.96 PSI	20.04 PSI	19.97 PSI	20.03 PSI
-12.00 PSI	-12.06 PSI	-11.94 PSI	-12.04 PSI	-11.96 PSI	-12.03 PSI	-11.97 PSI
<b>717 500G, 500 Range</b>						
	<b>&lt;V3.9</b>	<b>&lt;V3.9</b>	<b>&gt;V4 1 Yr</b>	<b>&gt;V4 1 Yr</b>	<b>&gt;V4 6 Mo</b>	<b>&gt;V4 6 Mo</b>
<b>Applied</b>	<b>Lower Limit</b>	<b>Upper Limit</b>	<b>Lower Limit</b>	<b>Upper Limit</b>	<b>Lower Limit</b>	<b>Upper Limit</b>
0.00 PSI	-0.25 PSI	0.25 PSI	-0.18 PSI	0.18 PSI	-0.13 PSI	0.13 PSI
100.00 PSI	99.75 PSI	100.25 PSI	99.82 PSI	100.18 PSI	99.87 PSI	100.13 PSI
200.00 PSI	199.75 PSI	200.25 PSI	199.82 PSI	200.18 PSI	199.87 PSI	200.13 PSI
300.00 PSI	299.75 PSI	300.25 PSI	299.82 PSI	300.18 PSI	299.87 PSI	300.13 PSI
400.00 PSI	399.75 PSI	400.25 PSI	399.82 PSI	400.18 PSI	399.87 PSI	400.13 PSI
500.00 PSI	499.75 PSI	500.25 PSI	499.82 PSI	500.18 PSI	499.87 PSI	500.13 PSI
400.00 PSI	399.75 PSI	400.25 PSI	399.82 PSI	400.18 PSI	399.87 PSI	400.13 PSI
300.00 PSI	299.75 PSI	300.25 PSI	299.82 PSI	300.18 PSI	299.87 PSI	300.13 PSI
200.00 PSI	199.75 PSI	200.25 PSI	199.82 PSI	200.18 PSI	199.87 PSI	200.13 PSI
100.00 PSI	99.75 PSI	100.25 PSI	99.82 PSI	100.18 PSI	99.87 PSI	100.13 PSI

**Table 62. 717 Pressure Verification (cont.)**

<b>717 1000G, 1000 Range</b>						
	<b>&lt;V3.9</b>	<b>&lt;V3.9</b>	<b>&gt;V4 1 Yr</b>	<b>&gt;V4 1 Yr</b>	<b>&gt;V4 6 Mo</b>	<b>&gt;V4 6 Mo</b>
<b>Applied</b>	<b>Lower Limit</b>	<b>Upper Limit</b>	<b>Lower Limit</b>	<b>Upper Limit</b>	<b>Lower Limit</b>	<b>Upper Limit</b>
0.0 PSI	-0.5 PSI	0.5 PSI	-0.4 PSI	0.4 PSI	-0.3 PSI	0.3 PSI
200.0 PSI	199.5 PSI	200.5 PSI	199.6 PSI	200.4 PSI	199.7 PSI	200.3 PSI
400.0 PSI	399.5 PSI	400.5 PSI	399.6 PSI	400.4 PSI	399.7 PSI	400.3 PSI
600.0 PSI	599.5 PSI	600.5 PSI	599.6 PSI	600.4 PSI	599.7 PSI	600.3 PSI
800.0 PSI	799.5 PSI	800.5 PSI	799.6 PSI	800.4 PSI	799.7 PSI	800.3 PSI
1000.0 PSI	999.5 PSI	1000.5 PSI	999.6 PSI	1000.4 PSI	999.7 PSI	1000.3 PSI
800.0 PSI	799.5 PSI	800.5 PSI	799.6 PSI	800.4 PSI	799.7 PSI	800.3 PSI
600.0 PSI	599.5 PSI	600.5 PSI	599.6 PSI	600.4 PSI	599.7 PSI	600.3 PSI
400.0 PSI	399.5 PSI	400.5 PSI	399.6 PSI	400.4 PSI	399.7 PSI	400.3 PSI
200.0 PSI	199.5 PSI	200.5 PSI	199.6 PSI	200.4 PSI	199.7 PSI	200.3 PSI
<b>717 1500G, 1500 Range</b>						
	<b>&lt;V3.9</b>	<b>&lt;V3.9</b>	<b>&gt;V4 1 Yr</b>	<b>&gt;V4 1 Yr</b>	<b>&gt;V4 6 Mo</b>	<b>&gt;V4 6 Mo</b>
<b>Applied</b>	<b>Lower Limit</b>	<b>Upper Limit</b>	<b>Lower Limit</b>	<b>Upper Limit</b>	<b>Lower Limit</b>	<b>Upper Limit</b>
0.0 PSI	-0.8 PSI	0.8 PSI	-0.5 PSI	0.5 PSI	-0.4 PSI	0.4 PSI
300.0 PSI	299.2 PSI	300.8 PSI	299.5 PSI	300.5 PSI	299.6 PSI	300.4 PSI
600.0 PSI	599.2 PSI	600.8 PSI	599.5 PSI	600.5 PSI	599.6 PSI	600.4 PSI
900.0 PSI	899.2 PSI	900.8 PSI	899.5 PSI	900.5 PSI	899.6 PSI	900.4 PSI
1200.0 PSI	1199.2 PSI	1200.8 PSI	1199.5 PSI	1200.5 PSI	1199.6 PSI	1200.4 PSI
1500.0 PSI	1499.2 PSI	1500.8 PSI	1499.5 PSI	1500.5 PSI	1499.6 PSI	1500.4 PSI
1200.0 PSI	1199.2 PSI	1200.8 PSI	1199.5 PSI	1200.5 PSI	1199.6 PSI	1200.4 PSI
900.0 PSI	899.2 PSI	900.8 PSI	899.5 PSI	900.5 PSI	899.6 PSI	900.4 PSI
600.0 PSI	599.2 PSI	600.8 PSI	599.5 PSI	600.5 PSI	599.6 PSI	600.4 PSI
300.0 PSI	299.2 PSI	300.8 PSI	299.5 PSI	300.5 PSI	299.6 PSI	300.4 PSI

Table 62. 717 Pressure Verification (cont.)

717 3000G, 3000 Range						
	<V3.9	<V3.9	>V4 1 Yr	>V4 1 Yr	>V4 6 Mo	>V4 6 Mo
Applied	Lower Limit	Upper Limit	Lower Limit	Upper Limit	Lower Limit	Upper Limit
0.0 PSI	-1.5 PSI	1.5 PSI	-1.1 PSI	1.1 PSI	-0.8 PSI	0.8 PSI
600.0 PSI	598.5 PSI	601.5 PSI	598.9 PSI	601.1 PSI	599.2 PSI	600.8 PSI
1200.0 PSI	1198.5 PSI	1201.5 PSI	1198.9 PSI	1201.1 PSI	1199.2 PSI	1200.8 PSI
1800.0 PSI	1798.5 PSI	1801.5 PSI	1798.9 PSI	1801.1 PSI	1799.2 PSI	1800.8 PSI
2400.0 PSI	2398.5 PSI	2401.5 PSI	2398.9 PSI	2401.1 PSI	2399.2 PSI	2400.8 PSI
3000.0 PSI	2998.5 PSI	3001.5 PSI	2998.9 PSI	3001.1 PSI	2999.2 PSI	3000.8 PSI
2400.0 PSI	2398.5 PSI	2401.5 PSI	2398.9 PSI	2401.1 PSI	2399.2 PSI	2400.8 PSI
1800.0 PSI	1798.5 PSI	1801.5 PSI	1798.9 PSI	1801.1 PSI	1799.2 PSI	1800.8 PSI
1200.0 PSI	1198.5 PSI	1201.5 PSI	1198.9 PSI	1201.1 PSI	1199.2 PSI	1200.8 PSI
600.0 PSI	598.5 PSI	601.5 PSI	598.9 PSI	601.1 PSI	599.2 PSI	600.8 PSI
717 5000G, 5000 Range						
	<V3.9	<V3.9	>V4 1 Yr	>V4 1 Yr	>V4 6 Mo	>V4 6 Mo
Applied	Lower Limit	Upper Limit	Lower Limit	Upper Limit	Lower Limit	Upper Limit
0.0 PSI	-2.5 PSI	2.5 PSI	-1.8 PSI	1.8 PSI	-1.3 PSI	1.3 PSI
1000.0 PSI	997.5 PSI	1002.5 PSI	998.2 PSI	1001.8 PSI	998.7 PSI	1001.3 PSI
2000.0 PSI	1997.5 PSI	2002.5 PSI	1998.2 PSI	2001.8 PSI	1998.7 PSI	2001.3 PSI
3000.0 PSI	2997.5 PSI	3002.5 PSI	2998.2 PSI	3001.8 PSI	2998.7 PSI	3001.3 PSI
4000.0 PSI	3997.5 PSI	4002.5 PSI	3998.2 PSI	4001.8 PSI	3998.7 PSI	4001.3 PSI
5000.0 PSI	4997.5 PSI	5002.5 PSI	4998.2 PSI	5001.8 PSI	4998.7 PSI	5001.3 PSI
4000.0 PSI	3997.5 PSI	4002.5 PSI	3998.2 PSI	4001.8 PSI	3998.7 PSI	4001.3 PSI
3000.0 PSI	2997.5 PSI	3002.5 PSI	2998.2 PSI	3001.8 PSI	2998.7 PSI	3001.3 PSI
2000.0 PSI	1997.5 PSI	2002.5 PSI	1998.2 PSI	2001.8 PSI	1998.7 PSI	2001.3 PSI
1000.0 PSI	997.5 PSI	1002.5 PSI	998.2 PSI	1001.8 PSI	998.7 PSI	1001.3 PSI
717 1000G, 10000 Range						
	V3.9	V3.9	V4 1 Yr	V4 1 Yr	V4 6 Mo	V4 6 Mo
Applied	Lower Limit	Upper Limit	Lower Limit	Upper Limit	Lower Limit	Upper Limit
0 PSI	-5 PSI	5 PSI	-5 PSI	5 PSI	-4 PSI	4 PSI
2000 PSI	1995 PSI	2005 PSI	1995 PSI	2005 PSI	1997 PSI	2004 PSI
4000 PSI	3995 PSI	4005 PSI	3995 PSI	4005 PSI	3997 PSI	4004 PSI
6000 PSI	5995 PSI	6005 PSI	5995 PSI	6005 PSI	5997 PSI	6004 PSI
8000 PSI	7995 PSI	8005 PSI	7995 PSI	8005 PSI	7997 PSI	8004 PSI
10000 PSI	9995 PSI	10005 PSI	9995 PSI	10005 PSI	9997 PSI	10004 PSI
8000 PSI	7995 PSI	8005 PSI	7995 PSI	8005 PSI	7997 PSI	8004 PSI
6000 PSI	5995 PSI	6005 PSI	5995 PSI	6005 PSI	5997 PSI	6004 PSI
4000 PSI	3995 PSI	4005 PSI	3995 PSI	4005 PSI	3997 PSI	4004 PSI
2000 PSI	1995 PSI	2005 PSI	1995 PSI	2005 PSI	1997 PSI	2004 PSI



4. Carefully vent all pressure and disconnect the 717 from the deadweight tester.

***mA Measure Verification***

1. Push  $\text{Ⓢ}$  to turn power on. The display should read:  
                   ----- mA  
 then change to:  
                   0.000 mA 0.00 PSI
2. Connect a test lead from Red AUX terminal of the 5520A to the Fluke 8508A I+ terminal.
3. Connect a test lead from Black AUX terminal of the 5520A to the 717 Calibrator Com terminal.
4. Connect a test lead from I- terminal of the Fluke 8508A to the 717 Calibrator mA terminal.
5. Adjust the 5520A if necessary, so that the current shown on the Fluke 8508A is the same as the 5520A values shown in Table 63.
6. Verify that the display readings on the 717 Calibrator are within the limits.

**Table 63. 717 mA Measure Verification**

Fluke 5520A	Fluke 717 (V2.9 and lower)	Fluke 717 (V3.0 and higher)
4.0000 mA	3.998 mA to 4.002 mA	3.997 mA to 4.003 mA
12.0000 mA	11.996 mA to 12.004 mA	11.996 mA to 12.004 mA
24.0000 mA	23.993 mA to 24.007 mA	23.994 mA to 24.006 mA

7. Disconnect the test leads and push  $\text{Ⓢ}$  to turn the power off.

***mA Loop Power Verification***

1. Hold down both LOOP POWER keys (  $\text{UNITS}$  and  $\text{Ⓢ}$  ) at the same until the screen reads:  
                   ----- LOOP mA  
 then release the keys.
2. Apply 1.2 k $\Omega$  to the mA jacks from the decade box or other resistor sources. The display should read >19 mA but <OL.
3. Push  $\text{Ⓢ}$  to turn the power off.

***Sensor Jack Verification***

1. Make sure nothing is connected to the sensor port of the Fluke 717.
2. Turn power on. The display should read:  
                   ----- mA  
 then change to:  
                   0.000 PSI
3. Plug the Fluke Pressure Module into the sensor port on the Fluke 717. The display should change to:  
                   ----- mA  
 A pressure value should appear on the screen after all the calibration constants have been down loaded.
4. Disconnect the Fluke Pressure Module and push  $\text{Ⓢ}$  to turn the Fluke 717 off.

## 718 and 718Ex Verification

This procedure is appropriate for the 718 and 718Ex. When the steps vary, the step will be labeled (718 Only) or (718Ex Only).

### Pressure Verification



#### Warning

**To avoid a violent release of pressure or vacuum, always depressurize the system slowly using the pressure/vacuum release control before detaching any pressure line.**

1. Carefully attach the pressure fitting of the deadweight tester to the pressure port of the Calibrator.

#### Note

*The use of TEFLON tape at the pressure fitting strengthens the seal.*

2. Push the green  key to turn the Calibrator on.
3. The display should read 0.00 PSI with the deadweight tester opened up to ambient air. If not, push the  key until display does read 0.00 PSI.
4. Depending if the instrument being tested is a 718(Ex) 1G, 30G, 100G, or 300G, set up the deadweight tester for the sequence of PSI inputs from Table 64 to be injected into the pressure port of the Calibrator.
5. Ensure the pressure has stabilized at each input before verifying the display reading.
6. Carefully vent all pressure and disconnect the Calibrator from the deadweight tester.

#### Note

*When verifying vacuum pressure make sure the pressure/vacuum switch is in the vacuum position. Forward (clockwise) is for pressure and backward (counter-clockwise) is for vacuum.*

**Table 64. 718 and 718Ex Pressure Verification**

718 1G, 2 Range						
	<V3.9	V3.9	V4 1 Yr	V4 1 Yr	V4 6 Mo	V4 6 Mo
Applied	Lower Limit	Upper Limit	Lower Limit	Upper Limit	Lower Limit	Upper Limit
0.0000 PSI	-0.0010 PSI	0.0010 PSI	-0.0010 PSI	0.0010 PSI	-0.0010 PSI	0.0010 PSI
0.1000 PSI	0.0990 PSI	0.1010 PSI	0.0990 PSI	0.1010 PSI	0.0990 PSI	0.1010 PSI
0.2000 PSI	0.1990 PSI	0.2010 PSI	0.1990 PSI	0.2010 PSI	0.1990 PSI	0.2010 PSI
0.3000 PSI	0.2990 PSI	0.3010 PSI	0.2990 PSI	0.3010 PSI	0.2990 PSI	0.3010 PSI
0.4000 PSI	0.3990 PSI	0.4010 PSI	0.3990 PSI	0.4010 PSI	0.3990 PSI	0.4010 PSI
0.5000 PSI	0.4990 PSI	0.5010 PSI	0.4990 PSI	0.5010 PSI	0.4990 PSI	0.5010 PSI
0.6000 PSI	0.5990 PSI	0.6010 PSI	0.5990 PSI	0.6010 PSI	0.5990 PSI	0.6010 PSI
0.7000 PSI	0.6990 PSI	0.7010 PSI	0.6990 PSI	0.7010 PSI	0.6990 PSI	0.7010 PSI
0.8000 PSI	0.7990 PSI	0.8010 PSI	0.7990 PSI	0.8010 PSI	0.7990 PSI	0.8010 PSI
0.9000 PSI	0.8990 PSI	0.9010 PSI	0.8990 PSI	0.9010 PSI	0.8990 PSI	0.9010 PSI
1.0000 PSI	0.9990 PSI	1.0010 PSI	0.9990 PSI	1.0010 PSI	0.9990 PSI	1.0010 PSI
-0.2000 PSI	-0.2010 PSI	-0.1990 PSI	-0.2010 PSI	-0.1990 PSI	-0.2010 PSI	-0.1990 PSI
-0.4000 PSI	-0.4010 PSI	-0.3990 PSI	-0.4010 PSI	-0.3990 PSI	-0.4010 PSI	-0.3990 PSI
-0.6000 PSI	-0.6010 PSI	-0.5990 PSI	-0.6010 PSI	-0.5990 PSI	-0.6010 PSI	-0.5990 PSI
-0.8000 PSI	-0.8010 PSI	-0.7990 PSI	-0.8010 PSI	-0.7990 PSI	-0.8010 PSI	-0.7990 PSI
-1.0000 PSI	-1.0010 PSI	-0.9990 PSI	-1.0010 PSI	-0.9990 PSI	-1.0010 PSI	-0.9990 PSI

**Table 64. 718 and 718Ex Pressure Verification (cont.)**

<b>718 &amp; 718Ex 30G, 42 Range</b>						
	<b>&lt;V3.9</b>	<b>&lt;V3.9</b>	<b>&gt;V4 1 Yr</b>	<b>&gt;V4 1 Yr</b>	<b>&gt;V4 6 Mo</b>	<b>&gt;V4 6 Mo</b>
<b>Applied</b>	<b>Lower Limit</b>	<b>Upper Limit</b>	<b>Lower Limit</b>	<b>Upper Limit</b>	<b>Lower Limit</b>	<b>Upper Limit</b>
0.000 PSI	-0.021 PSI	0.021 PSI	-0.015 PSI	0.015 PSI	-0.011 PSI	0.011 PSI
6.000 PSI	5.979 PSI	6.021 PSI	5.985 PSI	6.015 PSI	5.989 PSI	6.011 PSI
12.000 PSI	11.979 PSI	12.021 PSI	11.985 PSI	12.015 PSI	11.989 PSI	12.011 PSI
18.000 PSI	17.979 PSI	18.021 PSI	17.985 PSI	18.015 PSI	17.989 PSI	18.011 PSI
24.000 PSI	23.979 PSI	24.021 PSI	23.985 PSI	24.015 PSI	23.989 PSI	24.011 PSI
30.000 PSI	29.979 PSI	30.021 PSI	29.985 PSI	30.015 PSI	29.989 PSI	30.011 PSI
24.000 PSI	23.979 PSI	24.021 PSI	23.985 PSI	24.015 PSI	23.989 PSI	24.011 PSI
18.000 PSI	17.979 PSI	18.021 PSI	17.985 PSI	18.015 PSI	17.989 PSI	18.011 PSI
12.000 PSI	11.979 PSI	12.021 PSI	11.985 PSI	12.015 PSI	11.989 PSI	12.011 PSI
6.000 PSI	5.979 PSI	6.021 PSI	5.985 PSI	6.015 PSI	5.989 PSI	6.011 PSI
-12.000 PSI	-12.021 PSI	-11.979 PSI	-12.015 PSI	-11.985 PSI	-12.011 PSI	-11.989 PSI
<b>718 &amp; 718Ex 100G, 112 Range</b>						
	<b>&lt;V3.9</b>	<b>&lt;V3.9</b>	<b>&gt;V4 1 Yr</b>	<b>&gt;V4 1 Yr</b>	<b>&gt;V4 6 Mo</b>	<b>&gt;V4 6 Mo</b>
<b>Applied</b>	<b>Lower Limit</b>	<b>Upper Limit</b>	<b>Lower Limit</b>	<b>Upper Limit</b>	<b>Lower Limit</b>	<b>Upper Limit</b>
0.00 PSI	-0.06 PSI	0.06 PSI	-0.04 PSI	0.04 PSI	-0.03 PSI	0.03 PSI
20.00 PSI	19.94 PSI	20.06 PSI	19.96 PSI	20.04 PSI	19.97 PSI	20.03 PSI
40.00 PSI	39.94 PSI	40.06 PSI	39.96 PSI	40.04 PSI	39.97 PSI	40.03 PSI
60.00 PSI	59.94 PSI	60.06 PSI	59.96 PSI	60.04 PSI	59.97 PSI	60.03 PSI
80.00 PSI	79.94 PSI	80.06 PSI	79.96 PSI	80.04 PSI	79.97 PSI	80.03 PSI
100.00 PSI	99.94 PSI	100.06 PSI	99.96 PSI	100.04 PSI	99.97 PSI	100.03 PSI
80.00 PSI	79.94 PSI	80.06 PSI	79.96 PSI	80.04 PSI	79.97 PSI	80.03 PSI
60.00 PSI	59.94 PSI	60.06 PSI	59.96 PSI	60.04 PSI	59.97 PSI	60.03 PSI
40.00 PSI	39.94 PSI	40.06 PSI	39.96 PSI	40.04 PSI	39.97 PSI	40.03 PSI
20.00 PSI	19.94 PSI	20.06 PSI	19.96 PSI	20.04 PSI	19.97 PSI	20.03 PSI
-12.00 PSI	-12.06 PSI	-11.94 PSI	-12.04 PSI	-11.96 PSI	-12.03 PSI	-11.97 PSI

**Table 64. 718 and 718Ex Pressure Verification (cont.)**

718 & 718Ex 300G, 312 Range						
	<V3.9	<V3.9	>V4 1 Yr	>V4 1 Yr	>V4 6 Mo	>V4 6 Mo
Applied	Lower Limit	Upper Limit	Lower Limit	Upper Limit	Lower Limit	Upper Limit
0.00 PSI	-0.16 PSI	0.16 PSI	-0.16 PSI	0.16 PSI	-0.11 PSI	0.11 PSI
60.00 PSI	59.84 PSI	60.16 PSI	59.84 PSI	60.16 PSI	59.89 PSI	60.11 PSI
120.00 PSI	119.84 PSI	120.16 PSI	119.84 PSI	120.16 PSI	119.89 PSI	120.11 PSI
180.00 PSI	179.84 PSI	180.16 PSI	179.84 PSI	180.16 PSI	179.89 PSI	180.11 PSI
240.00 PSI	239.84 PSI	240.16 PSI	239.84 PSI	240.16 PSI	239.89 PSI	240.11 PSI
300.00 PSI	299.84 PSI	300.16 PSI	299.84 PSI	300.16 PSI	299.89 PSI	300.11 PSI
240.00 PSI	239.84 PSI	240.16 PSI	239.84 PSI	240.16 PSI	239.89 PSI	240.11 PSI
180.00 PSI	179.84 PSI	180.16 PSI	179.84 PSI	180.16 PSI	179.89 PSI	180.11 PSI
120.00 PSI	119.84 PSI	120.16 PSI	119.84 PSI	120.16 PSI	119.89 PSI	120.11 PSI
60.00 PSI	59.84 PSI	60.16 PSI	59.84 PSI	60.16 PSI	59.89 PSI	60.11 PSI
-12.00 PSI	-12.16 PSI	-11.84 PSI	-12.16 PSI	-11.84 PSI	-12.11 PSI	-11.89 PSI

**Leak Test Verification**

1. Seal off the pressure sensor input port.
2. Using the fine adjust knob, pressure-vacuum switch and internal pump, set the Calibrator to (approximately) the values in Table 65. Let the unit sit for one minute, then record the displayed value.
3. Wait for one more minute, then record a second reading. The difference between the first and the second reading is the leak rate.

**Table 65. 718 Leak Test Verification**

718 1G		718 30G	
Adjusted Pressure	Maximum Leak Rate	Adjusted Pressure	Maximum Leak Rate
-1.000 PSI	0.005 PSI/min	-10.000 PSI	0.05 PSI/min
1.000 PSI		3.000 PSI	
		30.000 PSI	
718 100G		718 300G	
Adjusted Pressure	Maximum Leak Rate	Adjusted Pressure	Maximum Leak Rate
-10.00 PSI	0.10 PSI/min	-10.00 PSI	0.3 PSI/min
3.00 PSI		3.00 PSI	
100.00 PSI		100.00 PSI	

**mA Measure Verification**

The display should indicate:

0.000mA 0.00 PSI

1. Connect a test lead from Red AUX terminal of the 5520A to the Fluke 8508A I+ terminal.
2. Connect a test lead from Black AUX terminal of the 5520A to the Calibrator Com terminal.
3. Connect a test lead from I- terminal of the Fluke 8508A to the Calibrator mA terminal.
4. Adjust the 5520A if necessary so that the current shown on the Fluke 8508A is the same as the 5520A values shown in Table 66.
5. Verify that the display readings on the Calibrator are within the limits.

**Table 66. 718 and 718Ex mA Measure Verification**

Fluke 5520A	Fluke 718 (V2.9 and lower)	Fluke 718 (V3.0 and higher)	Fluke 718Ex
4.0000 mA	3.998 mA to 4.002 mA	3.997 mA to 4.003 mA	3.997 mA to 4.003 mA
12.0000 mA	11.996 mA to 12.004 mA	11.996 mA to 12.004 mA	11.996 mA to 12.004 mA
24.0000 mA	23.993 mA to 24.007 mA	23.994 mA to 24.006 mA	23.993 mA to 24.007 mA

6. Disconnect the test leads and turn off the 718 Calibrator.

**mA Loop Power Verification (718 Only)**

1. Hold down both LOOP POWER keys ( UNITS and Ⓢ ) at the same time until the screen reads:
 

----- LOOP mA

 then release the keys.
2. Apply 1.2 kΩ to the mA jacks from the decade box or other resistor source. The display should read >19 mA but <OL.
3. Push Ⓢ to turn the Calibrator off.

**Sensor Jack Verification**

1. Make sure nothing is connected to the sensor port of the Calibrator. Push Ⓢ to turn the Calibrator on. The display should read:
 

-----

 then change to:
 

0.000
2. Plug the Fluke Pressure Module into the sensor port of the Fluke 718. The display should change to:
 

-----

 A pressure value should appear on the screen after all of the calibration constants have been downloaded.
3. Disconnect the Fluke Pressure Module and push Ⓢ to turn the Calibrator off.

### Display Verification

1. Push and hold the **ZERO** key and then push and release the green **Ⓢ** key. This locks the 718 in a mode where all display segments are on. All segments will stay on until the **ZERO** key is released.
2. Check to see that all segments of the display are showing.
3. Turn the Calibrator off. The 718 and 718Ex verification test is now complete.

### 719 Verification

This procedure is appropriate for the 719.

### Display Verification

1. Push and hold **Ⓢ**. This locks the 719 in a mode where all display segments are on. All segments will stay on until **Ⓢ** is released.
2. Check to see that all segments of the display are showing.

### Pressure Verification

#### **Warning**

**To avoid a violent release of pressure or vacuum, always depressurize the system slowly using the pressure/vacuum release control before detaching any pressure line.**

1. Carefully attach the pressure fitting of the deadweight tester to the pressure port of the Calibrator.

#### *Note*

*The use of TEFLON tape at the pressure fitting strengthens the seal.*

2. Push **Ⓢ** to turn the Calibrator on.
3. The display should read 0 PSI for the 30G and 0.00 PSI for the 100G with the deadweight tester opened up to ambient air. If not, push **ZERO** until display reads 0.00 PSI or 0.000 PSI.

#### *Note*

*The 719 vent should be closed and the pressure/vacuum switch should be in the Pressure position for pressure measurements.*

*When verifying vacuum measurement, make sure the pressure/vacuum switch is in the Vacuum position. Clockwise is for pressure and counter-clockwise is for vacuum.*

4. Setup the deadweight tester for the sequence of PSI inputs from Table 67 for the 719 being tested (30G or 100G). Ensure the pressure has stabilized at each input before verifying the display reading. Then proceed to the next value.
5. When complete, vent all pressure and disconnect the Calibrator from the deadweight tester.

**Table 67. 719 Pressure Verification**

<b>719 30G, 42 Range</b>				
	<b>1 Yr</b>	<b>1 Yr</b>	<b>6 Mo</b>	<b>6 Mo</b>
<b>Applied</b>	<b>Lower Limit</b>	<b>Upper Limit</b>	<b>Lower Limit</b>	<b>Upper Limit</b>
0.000 PSI	-0.015 PSI	0.015 PSI	-0.011 PSI	0.011 PSI
6.000 PSI	5.985 PSI	6.015 PSI	5.989 PSI	6.011 PSI
12.000 PSI	11.985 PSI	12.015 PSI	11.989 PSI	12.011 PSI
18.000 PSI	17.985 PSI	18.015 PSI	17.989 PSI	18.011 PSI
24.000 PSI	23.985 PSI	24.015 PSI	23.989 PSI	24.011 PSI
30.000 PSI	29.985 PSI	30.015 PSI	29.989 PSI	30.011 PSI
24.000 PSI	23.985 PSI	24.015 PSI	23.989 PSI	24.011 PSI
18.000 PSI	17.985 PSI	18.015 PSI	17.989 PSI	18.011 PSI
12.000 PSI	11.985 PSI	12.015 PSI	11.989 PSI	12.011 PSI
6.000 PSI	5.985 PSI	6.015 PSI	5.989 PSI	6.011 PSI
-12.000 PSI	-12.015 PSI	-11.985 PSI	-12.011 PSI	-11.989 PSI
<b>719 100G, 112 Range</b>				
	<b>1 Yr</b>	<b>1 Yr</b>	<b>6 Mo</b>	<b>6 Mo</b>
<b>Applied</b>	<b>Lower Limit</b>	<b>Upper Limit</b>	<b>Lower Limit</b>	<b>Upper Limit</b>
0.00 PSI	-0.04 PSI	0.04 PSI	-0.03 PSI	0.03 PSI
20.00 PSI	19.96 PSI	20.04 PSI	19.97 PSI	20.03 PSI
40.00 PSI	39.96 PSI	40.04 PSI	39.97 PSI	40.03 PSI
60.00 PSI	59.96 PSI	60.04 PSI	59.97 PSI	60.03 PSI
80.00 PSI	79.96 PSI	80.04 PSI	79.97 PSI	80.03 PSI
100.00 PSI	99.96 PSI	100.04 PSI	99.97 PSI	100.03 PSI
80.00 PSI	79.96 PSI	80.04 PSI	79.97 PSI	80.03 PSI
60.00 PSI	59.96 PSI	60.04 PSI	59.97 PSI	60.03 PSI
40.00 PSI	39.96 PSI	40.04 PSI	39.97 PSI	40.03 PSI
20.00 PSI	19.96 PSI	20.04 PSI	19.97 PSI	20.03 PSI
-12.00 PSI	-12.04 PSI	-11.96 PSI	-12.03 PSI	-11.97 PSI

**Leak Test Verification**

1. Seal off the pressure sensor input port.
2. Using the fine adjust knob, pressure-vacuum switch and internal pump, set the Calibrator to the values in Table 68. Let the unit sit for one minute, then record the displayed value.
3. Wait for one more minute, then record a second reading. The difference between the first and the second reading is the leak rate.

**Table 68. 719 Leak Test Verification**

719 30G		719 100G	
Adjusted Pressure	Maximum Leak Rate	Adjusted Pressure	Maximum Leak Rate
-10.00 PSI	0.05 PSI/min	-10.00 PSI	0.1 PSI/min
3.00 PSI		3.00 PSI	
30.00 PSI		100.00 PSI	

**mA Measure Verification**

The lower display should indicate:

0.000mA

1. Connect a test lead from Red AUX terminal of the 5520A to the Fluke 8508A I+ terminal.
2. Connect a test lead from Black AUX terminal of the 5520A to the Calibrator COM terminal.
3. Connect a test lead from I- terminal of the Fluke 8508A to the Calibrator mA terminal.
4. Adjust the 5520A so that the current shown on the Fluke 8508A is the same as the 5520A values shown in Table 69.
5. Verify that the display readings on the Calibrator are within the limits.

**Table 69. 719 mA Measure Verification**

Fluke 5520A	Fluke 719
4.0000 mA	3.997 mA to 4.003 mA
12.0000 mA	11.996 mA to 12.004 mA
24.0000 mA	23.993 mA to 24.007 mA

6. Disconnect the test leads and turn off the 719 Calibrator.



**mA Source Verification**

1. Turn ON the 719 Calibrator.  
When the display indicates a pressure and current value, for example:  
0.00 PSI  
0.000mA
2. Push **[mA]** three times, the lower display should read:  
Source 4.000mA  
The lower display will flash 4.000mA / OL until the circuit is complete.
3. Connect a test lead from Red Calibrator mA terminal to the Fluke 8508A I+ terminal.
4. Connect a test lead from the I-terminal of the Fluke 8508A to the Calibrator COM terminal.
5. Set the 8508A to DC mA.
6. Change the output mA value by pressing **[HOLD]** (Steps are 4 mA, 8 mA, 12 mA, 16 mA, 20 mA), or scroll the mA output value between 0...24 mA using **▲** or **▼**.
7. Verify that the current readings on the Fluke 8508 are within the limits shown in Table 70.
8. Disconnect the test leads and turn off the 719 Calibrator.

**Table 70. 719 mA Source Verification**

Fluke 719	Fluke 8508A
4.0000 mA	3.9974 mA to 4.0026 mA
12.0000 mA	11.9962 mA to 12.0038 mA
24.0000 mA	23.9944 mA to 24.0066 mA

### ***mA Loop Power Verification***

1. While turning the Calibrator on, hold down both LOOP POWER keys (ZERO and Ⓢ). The screen reads:  
----- LOOP mA
2. Release the keys.
3. Apply 1.2 kΩ to the mA jacks from the decade box or other resistor source. The lower display should read over 19 mA but less than OL.
4. Push Ⓢ to turn the Calibrator off.

### ***Sensor Jack Verification***

1. Make sure nothing is connected to the sensor port of the Calibrator. Push Ⓢ to turn the Calibrator on. The display should read:  
-----

2. Change to a near zero value, similar to:  
0.000

3. Plug the Fluke Pressure Module into the sensor port of the Fluke 719. The display should change to:  
-----

After a short wait, a pressure value should appear on the display.

4. Disconnect the Fluke Pressure Module and push Ⓢ to turn the Calibrator off.

The 719 verification test is now complete.

## ***Calibration***

Re-calibration (obtaining new calibration-constants) is required only if a Calibrator fails verification. Always re-verify after a re-calibration.

### *Note*

*Throughout this section, the 71X Calibrator may be referred to as the “UUT” (unit under test).*

### ***Preparing for Calibration***

To prepare for calibration, do the following:

1. Make sure fuse(s) in the UUT are intact. By referring to Table 38, you should not have to open the unit.
2. Make sure you have the required test equipment available. (Refer to Table 39.)
3. Turn on and warm up the test equipment for the time required.
4. Allow UUT to come to ambient temperature. Turn it on and allow 5 minutes for warm-up of the UUT.

## 712 Calibration (V1.1 and Earlier)

### Millivolts Measure

1. Hold down the  $\boxed{\text{RTD TYPE}}$  and the  $\boxed{^{\circ}\text{C}/^{\circ}\text{F}}$  key at the same time, then push and release the  $\text{\textcircled{O}}$  key.
2. When the display momentarily shows CAL, release both the  $\boxed{\text{RTD TYPE}}$  and the  $\boxed{^{\circ}\text{C}/^{\circ}\text{F}}$  keys. This puts the 712 into Cal Mode. The 712 should display:

INPUT 0.00 mV

3. Connect the test lead from the NORMAL jacks of the Fluke 5520A to the INPUT jacks (two middle jacks) on the 712 Calibrator (black to black, red to red).
4. Set the Fluke 5520A to 0.0000 mV and push  $\boxed{\text{OPR}}$ . Push any key on the 712 Calibrator. The display should read:

INPUT ---- mV

then change to:

INPUT 0.00 mV

5. Push any key on the 712 Calibrator. The display should read:

INPUT ---- mV

then change to:

INPUT 160.00 mV

6. Set the Fluke 5520A to 160.0000 mV.
7. Push any key on the 712 Calibrator. The display should read:

INPUT ---- mV

then change to:

INPUT 320.00 mV

8. Set the Fluke 5520A to 320.0000 mV.
9. Push any key on the 712 Calibrator. The display should read:

INPUT ---- mV

then change to:

INPUT 640.00 mV

10. Set the Fluke 5520A to 640.000 mV.
11. Push any key on the 712 Calibrator. The display should read:

INPUT ---- mV

then change to:

INPUT 1280.00 mV

12. Set the Fluke 5520A to 1280.000 mV.
13. Push any key on the 712 Calibrator. The display should read:

INPUT ---- mV

then change to:

INPUT 400.00 R 4W

### Resistance Measure

1. Connect two additional test leads from the NORMAL jacks of the 5520A to the 712 Calibrator (black wire to the 712 red jack labeled [3W NC] and red wire to the red jack labeled [4W NC]). All four input jacks of the 712 should now be in a 4-wire ohms measurement configuration.
2. Set the Fluke 5520A to 400.00  $\Omega$  and push  $\boxed{\text{OPR}}$ .
3. Push any key on the 712 Calibrator. The display should read:  
INPUT ---- R 4W  
then change to:  
INPUT ----

### mA Measure

1. Disconnect all four test leads from the Fluke 5520A and the 712 Calibrator.
2. Connect the two test leads from the AUX jacks on the Fluke 5520A to the middle jacks on the 712 Calibrator (black to black; red to red).
3. Push any key on the 712 Calibrator. The display will change to:  
INPUT 0.00 mA
4. Set the Fluke 5520A to 0.00000 mA and push  $\boxed{\text{OPR}}$ .
5. Push any key on the 712 Calibrator. The display should read:  
INPUT ---- mA  
then change to:  
INPUT 0.00 mA
6. Again, push any key on the 712 Calibrator, still with a 0.00000 mA input from the Fluke 5520A. The display should read:  
INPUT ---- mA  
then change to:  
INPUT 2.000 mA
7. Set the Fluke 5520A to 2.00000 mA.
8. Push any key on the 712 Calibrator. The display should read:  
INPUT ---- mA  
then change to:  
INPUT 0.500 mA
9. Set the Fluke 5520A to 0.50000 mA.
10. Push any key on the 712 Calibrator. The display should read:  
INPUT ---- mA
11. Push any key on the 712 Calibrator and the unit will automatically reset itself, with all segments momentarily being displayed. Calibrator is now out of CAL mode. Push the  $\text{\textcircled{C}}$  key to turn the Calibrator off and disconnect all test leads.

### 712 Calibration (V1.2 through V1.9)

1. Hold down  $\boxed{\text{RTD}}$  and  $\boxed{\text{C/F}}$  while turning the power on.
2. Hold the two keys until CAL is displayed, then release the two keys. The display should read:  
INPUT 15  $\Omega$
3. Connect the two test leads from the NORMAL jacks of the 5520A to the INPUT jacks (two middle jacks) on the 712 Calibrator (black to black, red to red).
4. Connect two additional test leads, also from the NORMAL jacks of the 5520A, to the 712 Calibrator (black wire to the 712 red jack labeled [3W NC] and red wire to the red jack labeled [4W NC]). All four input jacks of the 712 should now be configured in a 4-wire ohm measurement.
5. Set the Fluke 5520A to 15 $\Omega$  and push  $\boxed{\text{OPR}}$ .
6. Push  $\boxed{\text{C/F}}$ . The display should read:  
INPUT ----  $\Omega$ ,  
then change to:  
INPUT 350  $\Omega$
7. Set the Fluke 5520A to 350  $\Omega$ .
8. Push  $\boxed{\text{C/F}}$ . The display should read:  
INPUT ----  $\Omega$   
then change to:  
INPUT 500  $\Omega$ .
9. Set the Fluke 5520A to 500  $\Omega$ .
10. Push  $\boxed{\text{C/F}}$ . The display should read:  
INPUT ----  $\Omega$   
then change to:  
INPUT 3200  $\Omega$
11. Set the Fluke 5520A to 3200  $\Omega$ .
12. Push  $\boxed{\text{C/F}}$ . The display should read:  
INPUT ----  $\Omega$ .  
then change to:  
OUTPUT 17-50  $\Omega$ .
13. Using four test leads, connect the four jacks of Fluke 8508A ( $\Omega$  Sense 'Hi & Lo' and Input 'Hi & Lo') to the two middle jacks of the 712 Calibrator (black to black; red to red). This puts the Fluke 8508A in a 4-wire configuration.
14. Set the 3458A to the 1000  $\Omega$  range.
15. Push  $\boxed{\blacktriangle}$  and  $\boxed{\blacktriangledown}$  until the 712 display matches the Fluke 8508A.
16. Push  $\boxed{\text{C/F}}$ . The display should read:  
OUTPUT ----  $\Omega$   
then change to:  
OUTPUT 350.00 0.
17. Push  $\boxed{\blacktriangle}$  and  $\boxed{\blacktriangledown}$  until the 712 display matches the Fluke 8508A.

18. Push  $\text{°C/°F}$ . The display should read:

OUTPUT -----  $\Omega$

then change to:

OUTPUT 126.00  $\Omega$

19. Put the Fluke 8508A in the 10 k $\Omega$  range.

20. Push  $\blacktriangle$  and  $\blacktriangledown$  until the 712 display matches the Fluke 8508A.

21. Push  $\text{°C/°F}$ . The display should read:

OUTPUT -----  $\Omega$

then change to:

OUTPUT 2535.0  $\Omega$

22. Push  $\blacktriangle$  and  $\blacktriangledown$  until the 712 display matches the Fluke 8508A.

23. Push  $\text{°C/°F}$ . The display should read:

OUTPUT -----  $\Omega$

then the unit will reset.

24. Push the power key to turn the unit off and disconnect the test leads.

### **712 Calibration (V2.0 and Later)**

1. Hold down  $\text{RTD TYPE}$  and  $\text{°C/°F}$  while turning the power on.
2. The display shows CAL for 1 second and then xxx, where xxx is the number the times the unit has been through a calibration adjustment. When the two keys are released, PASS is displayed. One second later a zero is displayed for the most significant of the three-digit password. Use the two small arrows to change the number. After setting each digit, push  $\text{°C/°F}$ . If the password entry was correct, the 712 will go into calibration. If the password was wrong, the 712 will go into normal operation mode. The password is 217.
3. The calibration will be performed in the following order:

OHMS INPUT  
OHMS OUTPUT low range  
OHMS OUTPUT high range

### OHMS INPUT

1. In OHMS INPUT mode, the unit will display “C 15” for 1 second and then display the OHMS input using the default calibration.
2. Connect the test leads from the 5520 main Jacks to the 712 jacks in 4-wire configuration (2 wires at 5520, 4 wires at 712). The unit should read  $15.0 \Omega \pm 5\%$ .
3. Push  $\boxed{C/F}$  to go to the next calibration point. “C 400” will be displayed for 1 second and then it will display the ohms input.
4. Source  $400 \Omega$  from the 5520. The unit should read  $400.0 \Omega \pm 5\%$ .
5. Push  $\boxed{C/F}$  to go to the next calibration point. “C3200” will be displayed for 1 second and then it will display the ohms input.
6. Source  $3200 \Omega$  from the 5520. The unit should read  $3200.0 \Omega \pm 5\%$ .
7. Push  $\boxed{C/F}$  to complete OHMS INPUT calibration. “CHEC” will be displayed for 1 second. The new calibration constants are applied and the OHMS INPUT calibration can be checked.
8. Push  $\boxed{C/F}$  to go to the next mode.

### OHMS OUTPUT Low Range

1. In OHMS OUTPUT low range mode, the unit will display “15.00” and will source OHMS using the default calibration.
2. Connect the 712 to the DMM in OHMS read using 4 wire mode connection (2 wires at 712, 4 wires at DMM). The DMM should read  $15.00 \Omega \pm 5\%$ .
3. Adjust the value for OHMS OUTPUT using the arrows on the 712 keypad to source exactly  $15.00 \Omega$ .
4. Push  $\boxed{C/F}$  to go to the next calibration point. “400.00” will be displayed
5. Adjust using the arrows on the keypad to source exactly  $400.00 \Omega$ .
6. Push  $\boxed{C/F}$  to complete OHMS OUTPUT low range calibration. “CHEC” will be displayed for 1 second. The new calibration constants are applied and the calibration can be checked.
7. Push  $\boxed{C/F}$  to go to the next mode.

### OHMS OUTPUT High Range

1. In OHMS OUTPUT high range mode, the unit will display “20.0” and will source OHMS using the default calibration. Keep the connections from the previous mode. The DMM should read  $20.0 \Omega \pm 5\%$ .
2. Adjust the value for OHMS OUTPUT using the arrows on the 712 keypad to source exactly  $20.0 \Omega$ .
3. Push  $\boxed{C/F}$  to go to the next calibration point. “4000.0” will be displayed.
4. Adjust using the arrows on the keypad to source exactly  $4000.0 \Omega$ .
5. Push  $\boxed{C/F}$  to complete OHMS OUTPUT high range calibration. “CHEC” will be displayed for 1 second. The new calibration constants are applied and the calibration can be checked.
6. Push  $\boxed{C/F}$  to complete calibration.

## 714 Calibration (Earlier than V2.0)

### Temperature Measure

1. On the 714 Calibrator push and hold the  $\boxed{\text{TC TYPE}}$  and  $\boxed{\text{°C/°F}}$  keys, then turn on the 714 by pressing and releasing the  $\text{Ⓢ}$  key.
2. When the display momentarily shows CAL, release both the  $\boxed{\text{TC TYPE}}$  and  $\boxed{\text{°C/°F}}$  keys. This puts the 714 into the Cal Mode. The 714 should display:  
INPUT 0.00 mV
3. Connect the two-wire copper test lead (banana jacks to mini-connector) from the NORMAL jacks of the Fluke 5520A to the TC jack on the 714 Calibrator, observing correct polarity.

#### Note

*Copper wire must be used during this step.*

4. Set the Fluke 5520A to 0.0000 mV and push  $\boxed{\text{OPR}}$ .
5. Push any key on the 714 Calibrator. The display should read:  
INPUT ----- mV  
then change to:  
INPUT 77.00 mV
6. Set the Fluke 5520A to 77.0000 mV.
7. Push any key on the 714 Calibrator. The display should read:  
INPUT ----- mV  
then change to:  
OUTPUT mV

### Temperature Source

1. Remove the copper test lead from the 714 Calibrator.
2. Push any key on the 714 Calibrator. The display should read:  
OUTPUT ----- mV  
After a few seconds, the display should change to:  
TYPE J 0.0 °C

### Thermocouple Block Calibration

1. Connect the Type-J thermocouple test lead from the TC jack on the Fluke 5520A to the TC jack on the 714 Calibrator, observing correct polarity.

#### Note

*Type-J thermocouple wire (not copper) must be used.*

2. Set the Fluke 5520A to source Type-J thermocouple at 0.0 °C. Push  $\boxed{\text{OPR}}$ .
3. Push any key on the 714 Calibrator. The display will very quickly flash:  
TYPE J ----- °C  
then read:  
TYPE J HOLD °C
4. Wait for three to five minutes. The longer the waiting period, the more accurate the Thermo-block calibration will be.



5. Push any key on the 714 Calibrator. The display should read:

TYPE J ----- °C

then change to:

TYPE J 0.xx °C

This number represents the absolute error of the "CJC" sensor and should be below 1°C.



6. Push any key on the 714 Calibrator. The 714 should reset itself, displaying all segments momentarily. The display should then change to:

INPUT xx.x °C

where xx.x is some variable number; or OL (overload) may be indicated.



7. Push the  key to turn the Calibrator off and remove the Type J thermocouple test lead.

### 714 Calibration (V2.0 and Later)

1. On the 714 Calibrator push and hold the  and  keys, then turn on the 714 by pressing and releasing the  key.
2. The display shows CAL for 1 second and then xxx, where xxx is the number the times the unit has been through a calibration adjustment. When the two keys are released, PASS is displayed. One second later a zero is displayed for the most significant of the three digit password. Use the two small arrows to change the number. After setting each digit, push the °C/°F key. If the password entry was correct, the 714 will go into calibration. If the password was wrong, the 714 will go into normal operation mode. The password is 417.
3. The calibration will be performed in the following order:

mV OUTPUT  
mV INPUT  
CJC

### mV OUTPUT

1. In mV OUTPUT mode, the unit will display "C-10" for 1 second followed by "-10.000". The Calibrator is now sourcing mV using the default calibration. The 714 should source approximately -10.000mV through copper wire.
2. Adjust the source value using the up and down big arrows for gross and small arrows for fine, until you read -10.000mV.
3. Push  key to go to the next calibration point. "C 75" will be displayed for 1 second and then "75.000". The 714 should source approximately 75.000mV.
4. Adjust the source value until you read 75.000 mV on the DMM.
5. Push  to complete mV OUTPUT calibration.

### mV INPUT

1. In mV INPUT mode, the unit will display "C -10" for 1 second and then will display the input voltage using the default calibration.
2. Source -10.000 mV from the 5520. The unit should read approximately -10.000 mV through copper wire.
3. Push  to go to the next calibration point. "C 75" will be displayed for 1 second and then the input voltage.

4. Source 75.000 mV from the 5520. The unit should read approximately 75.000 mV.
5. Push  $\boxed{^{\circ}\text{C}/^{\circ}\text{F}}$  to complete mV INPUT calibration. "CHEC" will be displayed for 1 second. The new calibration constants are applied and the mV INPUT calibration can be checked.
6. Push  $\boxed{^{\circ}\text{C}/^{\circ}\text{F}}$  to go to the next mode.

### CJC

1. In CJC Cal Mode the unit will display "C CJC" for 1 second followed by IN 0°C for another second. Next it will display the difference between the temperature as measured by the CJC sensor and the temperature measured by a J type thermocouple.
2. Use the 5520 with J Type thermocouple wire to input a J type thermocouple signal of 0°C with CJC on.
3. When the number displayed on the 714 is stable, push the  $\boxed{^{\circ}\text{C}/^{\circ}\text{F}}$  to complete the calibration.

### 715 Calibration (Earlier than V2.0)

#### *mA/Volts Measure*

1. On the 715 Calibrator, hold down the  $\boxed{\frac{\text{V}}{\text{mV}}}$  and the  $\boxed{\frac{\text{mA}}{\%}}$  keys at the same time, then push and release the  $\text{Ⓢ}$  key.
2. When the display momentarily shows CAL, release the  $\boxed{\frac{\text{V}}{\text{mV}}}$  and the  $\boxed{\frac{\text{mA}}{\%}}$  keys. After CAL shows momentarily, the 715 will display:  
INPUT 0.000 mA
3. Connect two test leads from the AUX jacks of the Fluke 5520A to the middle mA input jacks on the 715 Calibrator (black to COM jack and red to mA jack).
4. Set the Fluke 5520A to 0.00000 mA and push  $\boxed{\text{OPR}}$ .
5. Push any key on the 715 Calibrator. The display should read:  
INPUT ---- mA  
then change to:  
INPUT 24.000 mA
6. Set the Fluke 5520A to 24.0000 mA.
7. Push any key on the 715 Calibrator. The display should read:  
INPUT ---- mA  
then change to:  
INPUT 0.000 V
8. Connect test lead from the NORMAL output jacks of the Fluke 5520A to the voltage jacks on the 715 Calibrator (black to COM jack and red to the V jack).
9. Set the Fluke 5520A to 0.0000 mV and push  $\boxed{\text{OPR}}$ .
10. Push any key on the 715. A relay will click and the display should read:  
INPUT ---- V  
then change to:  
INPUT 10.000 V
11. Set the Fluke 5520A to 10.00000 V.

12. Push any key on the 715 Calibrator. The display should read:

INPUT ---- V

then change to:

INPUT 0.00 mV

13. Set the Fluke 5520A to 0.0000 mV.

14. Push any key on the 715 Calibrator. The display should read:

INPUT ---- mV

then change to:

INPUT 100.00 mV

15. Set the Fluke 5520A to 100.0000 mV.

16. Push any key on the 715 Calibrator. The display should read:

INPUT ---- mV

then change to:

OUTPUT mV

### *mA/Volts Source Measure*

1. Remove all test leads from the 715 Calibrator.
2. Push any key on the 715 Calibrator. Display should change to:

OUTPUT ---- mV

After a couple of seconds, display should change to:

OUTPUT ---- V

After a couple more seconds, display should change to:

OUTPUT mA

3. Take one single test lead and plug one end into the V jack and the other end into the +LOOP jack of the 715 Calibrator (places a short between the two jacks).
4. Push any key on the 715 Calibrator. Display should read:

OUTPUT ---- mA

5. The 715 will then reset itself with all segments momentarily being displayed, then change to:

OUTPUT 0.0000 V

The 715 is now out of the CAL mode. Turn the green  $\odot$  key to turn the Calibrator off.

### *715 Calibration (V2.0 and Later)*

1. On the 715 Calibrator, hold down the  $\frac{V}{mV}$  and the  $\frac{mA}{\%}$  keys at the same time, then push and release the  $\odot$  key.
2. The display shows CAL for 1 second and then xxx, where xxx is the number the times the unit has been through a calibration adjustment. When the two keys are released, PASS is displayed. One second later, a zero is displayed for the most significant of the three-digit password. The 715 password is 517. Use the two small arrows to change the number. After setting each digit, push  $\frac{mA}{\%}$ . If the password entry was correct, 715 will go into calibration mode and the letter "K" will appear on the display. If the password was wrong, 715 will go into normal operation mode.

3. The calibration will be performed in the following order:

V INPUT  
mV INPUT  
mA INPUT  
V OUTPUT  
mV OUTPUT  
mA OUTPUT

### V INPUT

1. In V INPUT mode, the unit displays "CAL 0" for 1 second followed by the input voltage using the default calibration.
2. Connect the test leads from the 5520 main Jacks to the V and COM and source 0.0 V. The unit should read  $0.000V \pm 0.010V$ .
3. Push  $\left[ \begin{array}{c} \text{mA} \\ \% \end{array} \right]$  to go to the next calibration point. "CAL 25" will be displayed for 1 second and then the input voltage.
4. Source 25V from the 5520. The unit should read 25.000V with 5% tolerance.
5. Push  $\left[ \begin{array}{c} \text{mA} \\ \% \end{array} \right]$  to complete V INPUT calibration. "CHEC" will be displayed for 1 second. The new calibration constants are applied and the V INPUT calibration can be checked.
6. Set the 5520 to 0.0 and push the mA\_% key to go to the next mode.

### mV INPUT

1. In mV INPUT mode, the unit displays "CAL 0" for 1 second followed by the input voltage using the default calibration.
2. Source 0.0 mV from 5520. The unit should read  $0.00mV \pm 0.10mV$ .
3. Push  $\left[ \begin{array}{c} \text{mA} \\ \% \end{array} \right]$  to go to the next calibration point. "C 200" will be displayed for 1 second and then the input voltage.
4. Source 200 mV from the 5520. The unit should read 200.00V with 5% tolerance.
5. Push  $\left[ \begin{array}{c} \text{mA} \\ \% \end{array} \right]$  to complete mV INPUT calibration. "CHEC" will be displayed for 1 second. The new calibration constants are applied and the mV INPUT calibration can be checked.
6. Push  $\left[ \begin{array}{c} \text{mA} \\ \% \end{array} \right]$  to go to the next mode

### mA INPUT

1. In mA INPUT mode, the unit displays "CAL 0" for 1 second followed by the input mA using the default calibration.
2. Move the red test lead to mA jack.
3. Source 0.0 mA from 5520 using the AUX jacks. The unit should read  $0.000mA \pm 0.010mA$ .
4. Push  $\left[ \begin{array}{c} \text{mA} \\ \% \end{array} \right]$  to go to the next calibration point. "CAL24" will be displayed for 1 second and then the input mA.
5. Source 24mA from the 5520. The unit should read 24.000mA with 5% tolerance.
6. Push  $\left[ \begin{array}{c} \text{mA} \\ \% \end{array} \right]$  to complete mA INPUT calibration. "CHEC" will be displayed for 1 second. The new calibration constants are applied and the mA INPUT calibration can be checked.
7. Set the 5520 to STBY mode and push  $\left[ \begin{array}{c} \text{mA} \\ \% \end{array} \right]$  to go to the next mode.

### V OUTPUT

1. In V OUTPUT mode, the unit displays “C 0” for 1 second followed by “.0000”. The Calibrator is now sourcing V using the default calibration.
2. Connect the test leads from V and COM to V and COM of ....DMM. The 715 should source  $0.000V \pm 0.010V$ .
3. Adjust the source value using the up and down big arrows for gross and small arrows for fine adjustment, until you read 0.000 V on the DMM.
4. Push  $\frac{mA}{\%}$  to go to the next calibration point. “C 20” will be displayed for 1 second and then “.0000”. The 715 should source 20 V with 5% tolerance.
5. Adjust the source value until you read 20.000 on the DMM.
6. Push  $\frac{mA}{\%}$  to complete V OUTPUT calibration. “CHEC” will be displayed for 1 second. The new calibration constants are applied and the V OUTPUT calibration can be checked.
7. Push  $\frac{mA}{\%}$  to go to the next mode.

### mV OUTPUT

1. In mV OUTPUT mode, the unit displays “C 0” for 1 second followed by “0.000”. The Calibrator is now sourcing mV using the default calibration. 715 should source  $0.00mV \pm 0.10mV$ .
2. Adjust the source value using the up and down big arrows for gross and small arrows for fine, until you read 0.00mV on the DMM.
3. Push  $\frac{mA}{\%}$  to go to the next calibration point. “C 200” will be displayed for 1 second and then “0.000”. The 715 should source 200.00mV with 5% tolerance.
4. Adjust the source value until you read 200.00 mV on the DMM.
5. Push  $\frac{mA}{\%}$  to complete mV OUTPUT calibration. “CHEC” will be displayed for 1 second. The new calibration constants are applied and the mV OUTPUT calibration can be checked.
6. Push  $\frac{mA}{\%}$  to go to the next mode.

### mA OUTPUT

1. In mA OUTPUT mode, the unit displays “C 1” for 1 second followed by “.0000”. The Calibrator is now sourcing mA using the default calibration.
2. Connect the test leads from LOOP (red) and V (black) to mA and COM jacks of ....DMM. The 715 should source  $1.000mA \pm 0.010mA$ .
3. Adjust the source value using the up and down big arrows for gross and small arrows for fine adjustment, until you read 1.000mA on the DMM.
4. Push  $\frac{mA}{\%}$  to go to the next calibration point. “C 21” will be displayed for 1 second and then “.0000”. The 715 should source 21mA with 5% tolerance.
5. Adjust the source value until you read 21.000mA on the DMM.
6. Push  $\frac{mA}{\%}$  to complete mA OUTPUT calibration. “CHEC” will be displayed for 1 second. The new calibration constants are applied and the mA OUTPUT calibration can be checked.
7. Push  $\frac{mA}{\%}$  to complete the calibration and go to the normal mode.

## 717 Calibration (Earlier than V2.0)

### mA Measure

1. Hold down the **UNITS** and the **DAMP** keys at the same time, then push the green **Ⓢ** key. When the display shows CAL momentarily, release the **UNITS** and the **DAMP** keys immediately. After CAL shows, the display will automatically read:  
CAL 0.000mA
2. Connect the test leads from the AUX jacks of the Fluke 5520A to the mA jacks on the 717 Calibrator (Black to Black and Red to Red).
3. Set the Fluke 5520A to 0.00000 mA and push **OPR**.
4. Push any key on the 717 Calibrator. The display should change to:

----- 0.000mA

then to:

CAL 24.000mA

5. Set the Fluke 5520A to 24.0000 mA.
6. Push any key on the 717 Calibrator. Display should change from:

----- 24.000mA

to:

rAnGE

### Pressure Measure

1. Remove test leads from the 717 Calibrator and carefully attach the pressure fitting to the *pressure* jack on the 717 Calibrator.

#### Note

*The use of TEFLON tape at the pressure fittings strengthens the seal.*

2. For the 717 100G push the **MAX** key. For the 717 30G, push the **MIN** key. The display will flash for a short time:

----- rAnGE

then display:

CAL 0.00 PSI

3. Vent the system to ambient air to ensure 0.00 PSI.
4. Push any key on the 717 Calibrator. The display will change to read:

CAL ----- PSI

then depending on the model selected in step 2, change to either:

CAL 30.000 PSI

or

CAL 100.00 PSI

5. Set up the deadweight tester for 30 PSI (or 100 PSI) to be injected into the pressure port of the 717 Calibrator.

6. Once the pressure has stabilized, push any key on the 717 Calibrator. The display should read:  
CAL ----- PSI  
then depending on the model selected in step 2, change to either:  
CAL 15.000 PSI  
or  
CAL 50.000 PSI
7. Set the deadweight tester for 15 PSI (or 50 PSI) to be injected into the pressure port of the 717 Calibrator.
8. Once the pressure has stabilized, push any key on the 717 Calibrator. The display should read:  
CAL ----- PSI  
then the Calibrator will be out of CAL mode and in OPERATE mode. The display should read:  
0.000mA XX.xx PSI (where XX.xx is the applied pressure)  
If the display reads CALU, continue to step 9. If the 717 Calibrator is no longer in CAL mode, skip to step 11.
9. Push  to go to vacuum calibration. (Pressing any other key will end the calibration.) If you chose to calibrate vacuum, the display should read:  
CAL -12.000 PSI
10. Apply -12 PSI, wait for the vacuum standard to stabilize, then push any key. The display should show:  
-----
11. The unit will then reset power. The 717 is now out of the CAL mode and in the normal mode of operation. Vent all pressure/vacuum.

## 717 Calibration (V2.0 to V3.9)

### mA Measure

#### Note

For versions 3.00 and later, **CLR** has changed to **mA MODE**.

1. Hold down both **UNITS** and **DAMP** on the 717 Pressure Calibrator. Push and release **Ⓢ**.
2. The display shows CAL xxx, as long as **UNITS** and **DAMP** are pressed. Where xxx is a number, indicating the number of times the 717 has been through the calibration adjustment. When **UNITS** and **DAMP** are released, PASS is displayed. The password is required before you can enter the calibration mode. The password is 817. Enter the most significant digit first. The password appears below PASS. Use **CLR** to increase the displayed number, **HOLD** to decrease it. When the required digit appears, push **DAMP** to proceed to the next digit, or the password check. If the password entry was correct, the 717 will go to the CAL mode. If the password is incorrect, BAD PASS shows on the display and then the 717 returns to the normal operation mode. In the CAL mode, the 717 should display:

0.000 mA

in the upper display and

CAL 0 mA

on the lower line of the display.

The upper display shows an uncalibrated reading. This reading is approximately  $\pm 10\%$  of full scale of the applied reading. When **DAMP** is pressed, the calibration value is calculated relative to this reading. The lower display indicates what function and point is being calibrated.

3. Connect the test leads from the AUX jacks of the Fluke 5520A to the mA jacks on the 717 Calibrator (black to black and red to red).
4. Set the Fluke 5520A to 0.00000 mA and push **OPR**.
5. When 0.0 mA is sourced from the 5520A the upper display indicates about "0.000 mA". When **DAMP** is pushed, the unit establishes the calibration constant for that point and the lower display changes to "CAL 24 mA". The upper display still reflects the applied current so it does not change until after step 6 when 24 mA is applied."
6. Set the Fluke 5520A to 24.0000 mA.
7. The upper display reads approximately 24.000 mA. Push **DAMP** on the 717 Calibrator. CHEC appears on the lower display.
8. The CHEC mode allows for a quick check of the calibration constants that have just been stored. Changes to the applied current are reflected in the display. Push **DAMP** to continue. The lower display changes to:

rAnGE

### Pressure Measure

The 717 Pressure Calibrator has built-in temperature compensation. Instruments being calibrated should be in a stable temperature environment for several minutes before calibration. Calibration facilities should be maintained near 23 °C nominal.

Re-calibration (re-characterization) is performed in terms of 'PSI' pressure units. Inputs using other pressure units (ie. kPa and bar) must be mathematically converted.

#### Note

For versions 3.00 and later, **CLR** has changed to **mA MODE**.



1. Remove two-wire test lead from the 717 Calibrator and carefully attach the pressure fitting of the deadweight tester to the pressure jack on the 717 Calibrator.

*Note*

*The use of TEFLON tape at the pressure fittings strengthens the seal.*

2. The lower display shows rAnGE. This is an indication to choose the correct model of the 717 Calibrator. Choose the correct range. The appropriate range for the 717 is as follows:

717 1G (1)	717 300G (300)	717 1500G (1500)
717 30G (30)	717 500G (500)	717 3000G (3000)
717 100G (100)	717 1000G (1000)	717 5000G (5000)

The upper display shows 30, which is the default pressure range. Pressing **CLR** ( $\leq$  version 2.0) changes the sensor range to 100 PSI, pressing **HOLD** changes it back to 30 PSI. For a  $\geq$  version 3.0 push **MODE** to uprange, hold to down range. Match the displayed range to the measurement range of the 717.

3. After selecting the proper range, push **DAMP** on the 717 Calibrator.
4. Vent the system to ambient air to ensure 0.00 PSI.
5. The lower display indicates C 0 PSI and the upper display indicates the current reading. When the unit is vented (step 5) the upper display will read 0.00  $\pm$  approximately 10 % of full scale. When **DAMP** is pressed, the lower display indicates the next pressure to apply. Apply the requested pressure that shows on the lower display and when the upper reading is stable, push **DAMP**. Repeat this until CHEC appears on the display.
6. The CHEC mode allows for a quick check of the calibration constants that have just been stored. Changes to the applied pressure reflect on the display. Push **DAMP** to continue. The unit will then reset power.
7. The 717 Calibrator is now out of the CAL mode and into the normal mode of operation. Carefully vent all pressure, push **Ⓞ** to turn the Calibrator off, and disconnect all pressure fittings.

### 717 Calibration (V4.0 and Later)

#### mA Measure

1. Hold down **UNITS** and **DAMP** on the 717. Push and release **Ⓞ**.
2. The display shows CAL xxx, while **UNITS** and **DAMP** are pushed. xxx is a number that shows you the number of times the 717 has gone through the calibration adjustment. When **UNITS** and **DAMP** are released, PASS is shown.
3. A password is necessary to get in to calibration mode. The password is 817. Record the most significant digit first. The password is shown below PASS. Use **▲** to increase the number shown, **▼** to decrease it. When the necessary digit is shown, push **DAMP** to go to the next digit, or the password check. If the password entry is correct, the 717 goes to the CAL mode. If the password is incorrect, BAD PASS shows on the display and the 717 changes back to normal operation mode.
4. In the CAL mode the upper display shows an uncalibrated indication. This indication is approximately  $\pm 10$  % of full scale of the applied reading. When **DAMP** is pushed, the calibration value is calculated relative to this indication. The lower display shows the function and point that you are to calibrate.

In mA Measurement Calibration mode, the 717 will show:

mA on the upper display

and

CAL 0 mA on the lower display

5. Connect the test leads from the AUX jacks of the Fluke 5520A to the mA jacks on the 717 (black to black and red to red).
6. Set the Fluke 5520A to 0.00000 mA.
7. When 0.0 mA is sourced from the 5520A, the upper display shows approximately 0.000 mA. When **DAMP** is pushed, the unit makes the calibration constant for that point and the lower display changes to CAL 12 mA. The upper display continues to show the applied current so it does not change until after 12 mA is applied.
8. Set the Fluke 5520A to 12.0000 mA. The upper display shows approximately 12.000 mA.
9. Push **DAMP** on the 717.
10. When 12.000 mA is sourced from the 5520A, the upper display shows approximately 24.000 mA. When **DAMP** is pushed, the 717 makes the calibration constant for that point and the lower display changes to CAL 24 mA. The upper display continues to show the applied current so it does not change until after 24 mA is applied.
11. Set the Fluke 5520A to 24.0000 mA.  
The upper display shows approximately 24.000 mA.
12. Push **DAMP** on the 717. CHEC is shown on the lower display. The CHEC mode lets you quickly examine the calibration constants that you have just stored. Changes to the applied current are shown on the display.
13. Push **DAMP** to continue. The lower display changes to:  
rAnGE

### **Pressure Measure**

The 717 has built-in temperature compensation. A stable temperature environment is necessary when you calibrate the Instruments. Calibration facilities must be kept near 23 °C nominal. Re-calibration (recharacterization) is done in terms of PSI pressure units. Inputs that use other pressure units (kPa and bar, for example) must be mathematically converted.

1. Disconnect the test lead from the 717 mA jacks and carefully attach the pressure fitting of the deadweight tester to the 717 pressure jack.

#### *Note*

*Use TEFLON tape at the pressure fittings to strengthen the seal.*

The lower display shows rAnGE.

The upper display must show the full-scale range for the 717, for example:

- For the 717 15G, upper display shows 15.
  - For the 717 100G, upper display shows 100.
2. After you measure the correct range, push **DAMP** to continue.
  3. Vent the system to ambient air to make sure 0.00 PSI or 0.000 PSI.

The lower display shows 0 PSI and the upper display shows the current indication. When the unit is vented, the upper display reads  $0.00 \pm$  approximately 10 % of full scale. When **[DAMP]** is pushed, the lower display shows the subsequent pressure to apply.

4. Apply the requested pressure that shows on the lower display and when the upper indication is stable, push **[DAMP]**.
5. Do step 4 again until the lower display shows negative pressure.
6. Apply requested negative pressures, push **[DAMP]**. CHEC is shown on the lower display.
7. The CHEC mode lets you quickly examine the calibration constants that have just been stored. Changes to the applied pressure are shown on the display.
8. Push **[DAMP]** to continue. The Calibrator will restart in normal mode.
9. The 717 is now out of the calibration mode and into the normal mode of operation. Carefully vent all pressure, push **[⊙]** to turn the 717 off.
10. Disconnect all pressure fittings.

### 718 Calibration (Earlier than V2.0)

#### mA Measure

1. On the 718 Pressure Calibrator hold down both the **[UNITS]** and **[DAMP]** keys. Push and release the **[⊙]** key.
2. When the display momentarily shows CAL, release the **[UNITS]** and the **[DAMP]** keys. This puts the 718 into Cal Mode. The 718 should display:  
CAL 0.000 mA
3. Connect the test leads from the AUX jacks of the Fluke 5520A to the mA jacks on the 718 Calibrator (black to black and red to red).
4. Set the Fluke 5520A to 0.00000 mA and push **[OPR]**.
5. Push any key on the 718 Calibrator. The display should read:  
---- 0.000 mA  
then change to:  
CAL 24.000 mA
6. Set the Fluke 5520A to 24.0000 mA.
7. Push any key on the 718 Calibrator. The display should read:  
---- 24.00 mA  
then change to:  
rAnGE

### Pressure Measure

The 718 Pressure Calibrators have built-in temperature compensation. Instruments being calibrated should be in a stable temperature environment for several minutes before calibration. Calibration facilities should be maintained near 23 °C nominal.

Re-calibration (re-characterization) is performed in terms of 'PSI' pressure units. Inputs using other pressure units (ie. kPa and bar) must be mathematically converted.

1. Remove two-wire test lead from the 718 Calibrator and carefully attach the pressure fitting of the deadweight tester to the *pressure* jack on the 718 Calibrator.

#### Note

*The use of TEFLON tape at the pressure fittings strengthens the seal.*

2. At this point, the display should be indicating "rAnGE". This is an indication to choose the correct model of the 718 Calibrator.

For 718 30G, push the MIN key. For 718 100G, push the MAX key. The display will flash for a short time:

----- rAnGE

then display:

CAL 0.00 PSI

3. Vent the system to ambient air to ensure 0.00 PSI.

Push any key on the 718 Calibrator. The display will change to read:

CAL ----- PSI

then change to:

CAL 30.000 PSI

or

CAL 100.00 PSI

depending on which model /range was selected in step 2.

5. Set up the deadweight tester for either 30 PSI or 100 PSI to be injected into the pressure port of the 718 Calibrator.

Once the pressure has stabilized, push any key on the 718 Calibrator. The display should read:

CAL ----- PSI

then change to:

CAL 15.000 PSI

or

CAL 50.00 PSI

depending on which model /range was previously selected.

6. Set the deadweight tester for either 15 PSI or 50 PSI.

7. Once the pressure has stabilized, push any key on the 718 Calibrator. The display should read:  
CAL ----- PSI  
then change to:  
CALU
8. Release pressure by venting the system.
9. Push the **MIN** key to go to vacuum calibration. Otherwise, push any key to finish calibration. If calibrating vacuum, the display should show:  
CAL -12.000 PSI
10. Make sure the pressure/vacuum switch is in the vacuum position. Forward (clockwise) is for pressure and backward (counter-clockwise) is for vacuum.
11. Set up the deadweight tester to apply -12.000 PSI.
12. Wait for the pressure standard to stabilize, then push any key.
13. The display should show:  
-----
14. The unit will then reset power.
15. The 718 Calibrator is now out of the CAL mode and into the normal mode of operation. Carefully vent all pressure, push the **⊙** key to turn the Calibrator off, and disconnect all pressure fittings.

### 718 Calibration (V2.0 to V3.9)

#### mA Measure

1. Hold down both **UNITS** and **DAMP** on the 718 Pressure Calibrator. Push and release **⊙**.

#### Note

For versions 3.00 and later, **CLR** has changed to **mA MODE**.

2. The display shows CAL xxx, as long as **UNITS** and **DAMP** are pressed. Where xxx is a number, indicating the number of times the 718Ex has been through the calibration adjustment. When **UNITS** and **DAMP** are released, PASS is displayed. The password is required before you can enter the calibration mode. The password is 817. Enter the most significant digit first. The password appears below PASS. Use **CLR** to increase the displayed number, **HOLD** to decrease it. When the required digit appears, push **DAMP** to proceed to the next digit, or the password check. If the password entry was correct, the 718 will go to the CAL mode. If the password is incorrect, BAD PASS shows on the display and then the 718Ex returns to the normal operation mode. In the CAL mode, the 718 should display:

0.000 mA

in the upper display and

CAL 0 mA

on the lower line of the display.

The upper display shows an uncalibrated reading. This reading is approximately  $\pm 10\%$  of full scale of the applied reading. When **DAMP** is pressed, the calibration value is calculated relative to this reading. The lower display indicates what function and point is being calibrated.

3. Connect the test leads from the AUX jacks of the Fluke 5520A to the mA jacks on the 718 Calibrator (black to black and red to red).

4. Set the Fluke 5520A to 0.00000 mA and push **OPR**.
5. When 0.0 mA is sourced from the 5520A the upper display indicates about "0.000 mA". When **DAMP** is pushed, the unit establishes the calibration constant for that point and the lower display changes to "CAL 24 mA". The upper display still reflects the applied current so it does not change until after step 6 when 24 mA is applied."
6. Set the Fluke 5520A to 24.0000 mA.
7. The upper display reads approximately 24.000 mA. Push **DAMP** on the 718 Calibrator. CHEC appears on the lower display.
8. The CHEC mode allows for a quick check of the calibration constants that have just been stored. Changes to the applied current are reflected in the display. Push **DAMP** to continue. The lower display changes to:

rAnGE

### Pressure Measure

The 718 Pressure Calibrator has built-in temperature compensation. Instruments being calibrated should be in a stable temperature environment for several minutes before calibration. Calibration facilities should be maintained near 23 °C nominal. Re-calibration (re-characterization) is performed in terms of 'PSI' pressure units. Inputs using other pressure units (ie. kPa and bar) must be mathematically converted.

#### Note

For versions 3.00 and later, **CLR** has changed to **TRIA MODE**.

1. Remove two-wire test lead from the 718 Calibrator and carefully attach the pressure fitting of the deadweight tester to the pressure jack on the 718 Calibrator.

#### Note

The use of TEFLON tape at the pressure fittings strengthens the seal.

2. The lower display shows rAnGE. This is an indication to choose the correct model of the 718 Calibrator. Choose the correct range. The appropriate range for the 718 is as follows:

718 1G (1)

718 30G (30)

718 100G (100)

718 300G (300)

For unit with V2.0 or less, the upper display shows 30, which is the default pressure range. Pressing **CLR** changes the sensor range to 100 PSI, pressing **HOLD** changes it back to 30 PSI. For a ≥ version 3.0 push **TRIA MODE** to uprange, hold to down range. Match the displayed range to the measurement range of the 718.

3. After selecting the proper range, push **DAMP** on the 718Ex Calibrator.
4. Vent the system to ambient air to ensure 0.00 PSI.
5. The lower display indicates C 0 PSI and the upper display indicates the current reading. When the unit is vented (step 5) the upper display will read 0.00 ± approximately 10 % of full scale. When **DAMP** is pressed, the lower display indicates the next pressure to apply. Apply the requested pressure that shows on the lower display and when the upper reading is stable, push **DAMP**. Repeat this until CHEC appears on the display.

6. The CHEC mode allows for a quick check of the calibration constants that have just been stored. Changes to the applied pressure reflect on the display. Push **DAMP** to continue. The unit will then reset power.
7. The 718 Calibrator is now out of the CAL mode and into the normal mode of operation. Carefully vent all pressure, push **⊙** to turn the Calibrator off, and disconnect all pressure fittings.

### 718 Calibration (V4.0 and Later)

#### mA Measure

1. Hold down both **UNITS** and **DAMP** on the 718 Pressure Calibrator. Push and release **⊙**.  
The display shows CAL xxx, as long as **UNITS** and **DAMP** are pushed. Where xxx is a number, that tells you the number of times the 718 has been through the calibration adjustment. When **UNITS** and **DAMP** are released, PASS is shown.

2. A password is required to enter calibration mode. The password is 817. Enter the most significant digit first. The password appears below PASS. Use **▲** to increase the shown number, **▼** to decrease it. When the required digit is shown, push **DAMP** to go to the next digit, or the password check. If the password entry was correct, the 718 will go to the CAL mode. If the password is incorrect, BAD PASS shows on the display and the 718 returns to the normal operation mode.

In the CAL mode the upper display shows an uncalibrated reading. This reading is approximately  $\pm 10\%$  of full scale of the applied reading. When **DAMP** is pressed, the calibration value is calculated relative to this reading.

The lower display shows what function and point is being calibrated.

In mA Measurement calibration mode, the 718 should show:

mA on the upper display

and

CAL 0 mA on the lower display.

3. Connect the test leads from the AUX jacks of the Fluke 5520A to the mA jacks on the 718 Calibrator (black to black and red to red).
4. Set the Fluke 5520A to 0.00000 mA.

When 0.0 mA is sourced from the 5520A the upper display shows approximately 0.000 mA. When **DAMP** is pushed, the unit establishes the calibration constant for that point and the lower display changes to CAL 12 mA. The upper display still shows the applied current so it does not change until after 12 mA is applied.

5. Set the Fluke 5520A to 12.0000 mA. The upper display reads approximately 12.000 mA.
6. Push **DAMP** on the 718.

When 12.000 mA is sourced from the 5520A, the upper display shows approximately 24.000 mA. When **DAMP** is pushed, the unit establishes the calibration constant for that point and the lower display changes to CAL 24 mA. The upper display still shows the applied current so it does not change until after 24 mA is applied.

7. Set the Fluke 5520A to 24.0000 mA.  
The upper display shows approximately 24.000 mA.
8. Push **DAMP** on the 718. CHEC appears on the lower display.

The CHEC mode allows for a quick check of the calibration constants that have just been stored. Changes to the applied current are shown in the display.

9. Push **DAMP** to continue. The lower display changes to:  
rAnGE

### **Pressure Measure**

The Calibrator has built-in temperature compensation. Instruments being calibrated should be in a stable temperature environment for several minutes before calibration.

Calibration facilities should be maintained near 23 °C nominal. Re-calibration (recharacterization) is performed in terms of PSI pressure units. Inputs using other pressure units (kPa and bar, for example) must be mathematically converted.

1. Disconnect the test lead from the 718 Calibrator mA jacks and carefully attach the pressure fitting of the deadweight tester to the Calibrator's pressure jack.

#### *Note*

*The use of TEFLON tape at the pressure fittings strengthens the seal.*

The lower display shows rAnGE.

The upper display should show the full-scale range for the 718, for example:

- For the 718 1G, upper display should show 1.
- For the 718 100G, upper display should show 100.

2. After you check the proper range, push **DAMP** to continue.
3. Vent the system to ambient air to ensure 0.00 PSI or 0.000 PSI.

The lower display shows 0 PSI and the upper display shows the current reading. When the unit is vented, the upper display will show  $0.00 \pm$  approximately 10 % of full scale.

4. When you push **DAMP**, the lower display shows the next pressure to apply.
5. Apply the requested pressure that shows on the lower display and when the upper reading is stable, push **DAMP**.
6. Repeat this until lower display shows negative pressure.
7. Turn the pressure/vacuum switch to the vacuum position.
8. Apply requested negative pressure and push **DAMP**.

CHEC shows on the lower display.

The CHEC mode allows for a quick check of the calibration constants that have just been stored. Changes to the applied pressure are shown on the display.

9. Push **DAMP** to continue. The 718 will restart in normal mode.

The 718 is now out of the Calibration mode and in the normal mode of operation.

10. Carefully vent all pressure, push **Ⓢ** to turn the 718 off. Disconnect all pressure fittings.



## 718Ex Calibration

### mA Measure

1. Hold down both **UNITS** and **DAMP** on the 718Ex Pressure Calibrator. Push and release **Ⓢ**.
2. The display shows CAL xxx, as long as **UNITS** and **DAMP** are pressed. Where xxx is a number, indicating the number of times the 718Ex has been through the calibration adjustment. When **UNITS** and **DAMP** are released, PASS is displayed. The password is required before you can enter the calibration mode. The password is 817. Enter the most significant digit first. The password appears below PASS. Use **CLR** to increase the displayed number, **HOLD** to decrease it. When the required digit appears, push **DAMP** to proceed to the next digit, or the password check. If the password entry was correct, the 718Ex will go to the CAL mode. If the password is incorrect, BAD PASS shows on the display and then the 718Ex returns to the normal operation mode. In the CAL mode, the 718Ex should display:

0.000 mA

in the upper display and

CAL 0 mA

on the lower line of the display.

The upper display shows an uncalibrated reading. This reading is approximately  $\pm 10\%$  of full scale of the applied reading. When **DAMP** is pressed, the calibration value is calculated relative to this reading. The lower display indicates what function and point is being calibrated.

3. Connect the test leads from the AUX jacks of the Fluke 5520A to the mA jacks on the 718Ex Calibrator (black to black and red to red).
4. Set the Fluke 5520A to 0.00000 mA and push **OPR**.
5. When 0.0 mA is sourced from the 5520A the upper display indicates about "0.000 mA". When **DAMP** is pushed, the unit establishes the calibration constant for that point and the lower display changes to "CAL 24 mA". The upper display still reflects the applied current so it does not change until after step 6 when 24 mA is applied."
6. Set the Fluke 5520A to 24.0000 mA.
7. The upper display reads approximately 24.000 mA. Push **DAMP** on the 718Ex Calibrator. CHEC appears on the lower display.
8. The CHEC mode allows for a quick check of the calibration constants that have just been stored. Changes to the applied current are reflected in the display. Push **DAMP** to continue. The lower display changes to:

rAnGE

### Pressure Measure

The 718Ex Pressure Calibrator has built-in temperature compensation. Instruments being calibrated should be in a stable temperature environment for several minutes before calibration. Calibration facilities should be maintained near 23 °C nominal. Re-calibration (re-characterization) is performed in terms of 'PSI' pressure units. Inputs using other pressure units (ie. kPa and bar) must be mathematically converted.

1. Remove two-wire test lead from the 718Ex Calibrator and carefully attach the pressure fitting of the deadweight tester to the pressure jack on the 718Ex Calibrator.

#### Note

*The use of TEFLON tape at the pressure fittings strengthens the seal. For versions 2.0 and higher, the upper display should show the appropriate pressure sensor range. The range is set through the production process and cannot be changed.*

2. For version 2.0 and higher, skip to step 4. For version 1.9 or lower, the lower display shows rAnGE. This is an indication to choose the correct model of the 718Ex Calibrator. The appropriate range for the 718Ex 30G is 30 and 100 for the 718Ex 100G. Choose the correct range.
3. The upper display shows 30, which is the default pressure range. Pressing **CLR** changes the sensor range to 100 PSI, pressing **HOLD** changes it back to 30 PSI.
4. When proper range is shown, push **DAMP** on the 718Ex Calibrator.
5. Vent the system to ambient air to ensure 0.00 PSI.
6. The lower display indicates C 0 PSI and the upper display indicates the current reading. When the unit is vented (step 5) the upper display will read 0.00 ± approximately 10 % of full scale. When **DAMP** is pressed, the lower display indicates the next pressure to apply. Apply the requested pressure that shows on the lower display and when the upper reading is stable, push **DAMP**. Repeat this until CHEC appears on the display.
7. The CHEC mode allows for a quick check of the calibration constants that have just been stored. Changes to the applied pressure reflect on the display. Push **DAMP** to continue. The unit will then reset power.
8. The 718Ex Calibrator is now out of the CAL mode and into the normal mode of operation. Carefully vent all pressure, push **Ⓢ** to turn the Calibrator off, and disconnect all pressure fittings.

## 719 Calibration (V1.0)

### mA Measure

1. Hold down both  ZERO and  on the 719 Pressure Calibrator. Push and release .
2. The display shows CAL xxx, as long as  ZERO and  are pressed. Where xxx is a number, indicating the number of times the 719 has been through the calibration adjustment. When  ZERO and  are released, PASS is displayed.
3. A password is required to enter calibration mode. The password is 917. Enter the most significant digit first. The password appears below PASS. Use  ▲ to increase the displayed number,  ▼ to decrease it. When the required digit appears, push  to proceed to the next digit, or the password check. If the password entry was correct, the 719 will go to the CAL mode. If the password is incorrect, BAD PASS shows on the display and the 719 returns to the normal operation mode.
4. In the CAL mode the upper display shows an uncalibrated reading. This reading is approximately  $\pm 10\%$  of full scale of the applied reading. When  is pressed, the calibration value is calculated relative to this reading.
5. The lower display indicates what function and point is being calibrated.
6. In mA Measurement calibration mode, the 719 should display:  
mA on the upper display and  
CAL 0 mA on the lower display.
7. Connect the test leads from the AUX jacks of the Fluke 5520A to the mA jacks on the 719 Calibrator (black to black and red to red).
8. Set the Fluke 5520A to 0.00000 mA.
9. When 0.0 mA is sourced from the 5520A the upper display indicates approximately 0.000 mA. When  is pressed, the unit establishes the calibration constant for that point and the lower display changes to CAL 12 mA. The upper display still reflects the applied current so it does not change until after 12 mA is applied.
10. Set the Fluke 5520A to 12.00000 mA. The upper display reads approximately 12.000 mA.
11. Push  on the 719 Calibrator.
12. When 12.000 mA is sourced from the 5520A, the upper display indicates approximately 24.000 mA. When  is pressed, the unit establishes the calibration constant for that point and the lower display changes to CAL 24 mA. The upper display still reflects the applied current so it does not change until after 24 mA is applied.
13. Set the Fluke 5520A to 24.00000 mA.  
The upper display reads approximately 24.000 mA.
14. Push  on the 719 Calibrator.  
CHEC appears on the lower display.
15. The CHEC mode allows for a quick check of the calibration constants that have just been stored. Changes to the applied current are reflected in the display.
16. Push  to continue. The upper and lower display changes to - - - -. The Source, mA, Ref appear on the LCD, and the unit will proceed enters the mA output calibration section.

### *mA Output Calibration*

1. Connect a test lead across the Fluke 719 mA jacks, connecting red to black.
2. Push  to start the mA source calibration.
3. The unit will start its auto-calibration process for the mA output using an internal mA measurement circuit calibrated at previous stage. It will generate 17 different output values, measure each of them, and save the measured values as calibration points.
  - The upper display indicates measured output current in mA for the point which is being calibrated.
  - The lower display indicates expected output current in mA for the point which is being calibrated.
  - During this process the unit checks if the measured values fit in  $\pm 15\%$  range of expected values. If all 17 values are within range, the upper display indicates DONE.
  - If any of these values were out of the range, the upper display indicates ErrOr and the lower display shows the amount of errors.
  - The mA OUTPUT self-calibration takes approximately 30 seconds.
4. Push  to continue. The lower display changes to:  
rAnGE

### *Pressure Measure*

The Calibrator has built-in temperature compensation. Instruments being calibrated should be in a stable temperature environment for several minutes before calibration. Calibration facilities should be maintained near 23 °C nominal. Re-calibration (re-characterization) is performed in terms of PSI pressure units. Inputs using other pressure units (ie. kPa and bar) must be mathematically converted.

1. Disconnect the test lead from the 719 Calibrator mA jacks and carefully attach the pressure fitting of the deadweight tester to the Calibrator's pressure jack.

#### *Note*

*The use of TEFLON tape at the pressure fittings strengthens the seal.*

The lower display shows rAnGE.

The upper display should show appropriate range for the 719 as follows:

- For the 719 30G, upper display should show 30.
- For the 719 100G, upper display should show 100.

2. After checking the proper range, push  to continue.
3. Vent the system to ambient air to ensure 0.00 PSI or 0.000 PSI.  
The lower display indicates 0 PSI and the upper display indicates the current reading. When the unit is vented, the upper display will read  $0.00 \pm$  approximately 10 % of full scale. When  is pressed, the lower display indicates the next pressure to apply.
4. Apply the requested pressure that shows on the lower display and when the upper reading is stable, push .
5. Repeat this until lower display indicates negative pressure.
6. Turn the pressure/vacuum switch to the vacuum position.
7. Apply requested negative pressure, push .  
CHEC appears on the lower display.  
The CHEC mode allows for a quick check of the calibration constants that have just been stored. Changes to the applied pressure are shown on the display.
8. Push  to continue. The Calibrator will restart in normal mode.

The 719 Calibrator is now out of the Calibration mode and into the normal mode of operation. Carefully vent all pressure, push  to turn the Calibrator off, and disconnect all pressure fittings.

## Replacement Parts and Accessories

Table 71 lists the replaceable parts and accessories for the 71X Calibrators. See Figure 7 for an exploded view of the 718 Calibrator. Fluke repair is recommended for the 718Ex and no 718Ex replacement parts are listed in Table 71.

*Note*

*Not all parts listed in Table 71 are shown in Figure 7.*

**Table 71. Replaceable Parts and Accessories**

Ref. Des.	Description	PN or Model No.	Used On	Qty.
A1	Assembly	690906 691147	718 30G 718 100G	1
BT1, BT2	9V battery, ANSI/NEDA 1604A or IEC 6LR61	614487	71X	1
△F1	Fuse, 125 mA, 250V fast	686527	71X	1
△F2	Fuse, 125 mA, 250V fast	686527	715	1
H2,3,4	Case screw	832246	71X	3
H5,6	Battery door fasteners	948609	71X	2
H7,8	Bracket screw	641131	718	2
MP1	LCD Bezel	620242 620275 646866 2545064 663997 1638728 2545073 2545099 2545105 2545110 2545122 2545131 2545047 664158 664169 2545058 3315371 3322226 4058824 4058836	712 714 714 717 1G 717 30G 717 100G 717 300G 717 500G 717 1000G 717 1500G 717 3000G 717 5000G 718 1G 718 30G 718 100G 718 300G, 719 30G, 719 100G 717 15G 717 1000G	1
MP2	LCD	686490 686482  3345775 2725782  2550335	712,714,715 717,718, 719 717-8 V3.0 or later 712, 714, 715, V2.0 or later	1
MP6	1G Pump	2571725	718	1
MP6	Fluke-718, 30G/100G, Pump with clean out	2558508	718	1
MP6	Fluke-718, 300G, Pump with clean out	2632057	718	1
MP6	718-719 Vernier assembly	33774652	718-719	1
MP6	719 pump body	3345794	719	1
MP6	719 pump Motor w/Gearhead	3345802	719	1
MP7	719 Selector knob	3330284	719	1
MP7,8	Selector knob	664193	718	2
MP9	Vernier adjust knob	664190	718	1
MP10	Pump handle knob	664185	718	1
MP11,12,13	O-ring, for pressure input	146688	717,718	1

**Table 71. Replaceable Parts and Accessories (cont.)**

Ref. Des.	Description	PN or Model No.	Used On	Qty.
MP14	Spacer for pressure input	687449	717,718	1
MP20	Shield, LCD, Top Case	687092	71X	1
MP21	LCD Zebra Strip	643376	71X	2
MP22	O-ring for input/output receptacle	831933	712,715	1
MP85	Case top  with LEMO	620192 620234 620200 690997 1640322 690997 691147 3255195 2402610  2097409 2097411 3315493	712 714 715 717 30G 717 100G 718 30G 718 100G 718Ex 30 712 V2.0 or later 718EX 30G 718EX 100G 719	1
MP86	Case bottom  W/Pump Cleanout	620168 664174 3242728 2397526  3315686	71X 718 718EX 715/717 V2.0 or later 719	1
-	718 1G Top Case Decal	2546993		1
-	718 30G Top Case Decal	2547000		1
-	718 100G Top Case Decal	2547017		1
-	718 300G Top Case Decal	2547021		1
MP89, 90	Non-skid foot	824466	71X	2
MP92	Battery door	609930 664177	71X 718	1
S1	Keypad	687084 687076 687100 2113087 687068  2113087  2558474 3315673	712 714 715 718 717,718 V1.4 or less 717,718 V2.0 to V2.9 717,718 V3.0 or later 719	1
TM1	712 Instruction Sheet 714 Instruction Sheet 715 Instruction Sheet 717 30G/100G Instruction Sheet 718Ex Control Drawing (CCD)	650280 650306 650314 690013 6800013	712 714 715 717 718Ex	1
TM2 (not shown)	718 30G/100G Users Manual (on CD) 718Ex 30G/100G Users Manual (on CD) 719 Users Manual (on CD)	1549626 2097427 3316449	718 718Ex 719	1

Table 71. Replaceable Parts and Accessories (cont.)

Ref. Des.	Description	PN or Model No.	Used On	Qty.
-	Holster, yellow	664182	718	1
-	Fluke-7XX Test Lead Set	3397308	712	2
<b>ACCESSORIES</b>				
AC175	Alligator Clip, Black Alligator Clip, Red	4239092 4239050	715 718	1 1
CG81Y	Holster, Yellow	2074033	71X	1
TL20	Industrial Test Lead Set	1639457	715 717	Option
TL75	Test lead set Cap, Black Cap, Red	855742 3986568 3995524	715 717	1 1 1
Not Shown	718 Pump Rebuild Kit	2553919	718	Option
Not Shown	719 Pump Rebuild Kit	3345816	719	Option
Not Shown	71X Series Calibration Manual	available at <a href="http://www.fluke.com">www.fluke.com</a>	71X	Option
Parts are for all 71X Calibrators unless specified. ⚠ For safety, use exact replacement only.				

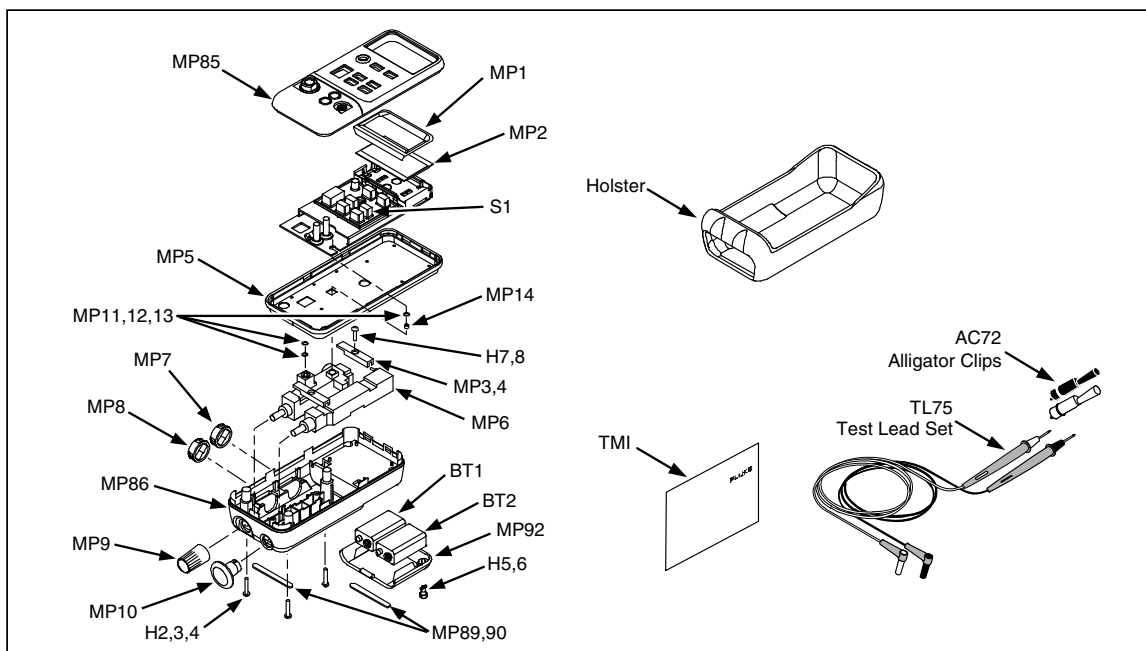

Figure 7. Replacement Parts (718 shown)

wh004f.emf