

MAX!

Radiator Thermostat basic



Operating manual

BC-RT-TRX-CyN

Package contents

Quantity	Item
----------	------

1x	MAX! Radiator Thermostat basic
1x	Danfoss RA adapter
1x	Cylinder head screw M4 x 12 mm, nut M4
1x	Support ring
2x	1.5 V LR6/mignon/AA batteries
3x	Brief instruction in German/English, French/ Dutch and Polish/Italian

Table of contents

1	Information about this manual.....	4
2	Safety instructions.....	4
3	Function.....	6
4	Device overview.....	8
5	Display content in normal mode.....	9
6	Start-up.....	9
7	Teaching-in.....	16
8	Auto/Manu.....	19
9	Boost.....	20
10	Comfort and reduction temperature.....	21
11	Child safeguard/operating lock.....	22
12	Configuration of the MAX! system.....	22
13	Restore factory settings.....	23
14	LED flashing sequences and transmission behaviour.....	24
15	Maintenance and cleaning.....	26
16	Information about radio operation.....	27
17	Technical data.....	28

Documentation © 2015 eQ-3 AG, Germany

All rights reserved. Translation from the original version in German.

Version 1.0 (05/2017)

1 INFORMATION ABOUT THIS MANUAL

Read this manual carefully before starting to use the device. Keep the manual for later consultation. If you hand over the device to other persons for use, please hand over the operating manual as well.

Symbols used:



Attention!

This indicates a hazard.



Note.

This section contains important additional information!

2 SAFETY INSTRUCTIONS



We do not assume any liability for damage to property or personal injury caused by improper use or the failure to observe the safety instructions. In such cases, any claim under warranty is extinguished! For consequential damages, we assume no liability! Especially observe the safety and handling instructions in chapter “6.2 Installation on the radiator” and the following.



Do not open the device. It does not contain any parts that can be maintained by the user. In the event of an error, have the device checked by an expert.



Do not use the device if there are signs of damage to the housing or control elements, for example, or if it demonstrates a malfunction. If you have any doubts, please have the device checked by an expert.



For safety and licensing reasons (CE), unauthorized change and/or modification of the product is not permitted.



The device may only be operated indoors and must be protected from the effects of moisture, vibrations, solar or other methods of heat radiation, cold and mechanical loads.



The device is not a toy; do not allow children to play with it. Do not leave packaging material lying around, plastic films/bags, pieces of polystyrene etc., can be dangerous in the hands of a child.



The system is only suitable for control of heaters (radiators, convection heaters, heater bars) heated by heat carriers. Any other use, e.g. on cooling systems, in-floor heating, etc., is not permitted and can lead to severe damages.



Use a dry linen cloth to clean the device. If the device is particularly dirty, you can slightly dampen the cloth to clean it. Do not use any detergents containing solvents for cleaning purposes. Make sure that no moisture will ingress into the housing.



Using this device for any purpose other than that described in this operating manual does not fall within the scope of intended use and shall invalidate any warranty or liability. This also applies to any conversion or modification work. The device is intended for private use only.

3 FUNCTION

The MAX! Radiator Thermostat basic is responsible for regulating the radiators within the MAX! system. During ventilation, the MAX! Radiator Thermostat automatically reduces the temperature in a room in order to save on energy costs.

Communication between the MAX! components is bidirectional. This ensures that the information sent reaches the recipient.

The configuration of the MAX! Radiator Thermostat depends on the system variant used. You have the possibility to choose between the following two variants:



MAX! House solution

This is the solution for the entire house. With a MAX! Cube, all settings of connected devices in your house can comfortably be made via the MAX! software.

By using the MAX! Cube, several MAX! Radiator solutions and MAX! Room solutions can be connected to a new MAX! House solution in a new installation. In this installation, the MAX! Eco Switch can optionally be integrated.



MAX! Room solution

In the room solution, the settings of all connected devices in your room can comfortably be made via the MAX! Wall Thermostat+. Up to 8 MAX! Radiator Thermostats and 8 MAX! Window Sensors can be connected and controlled via the MAX! Wall Thermostat+.

The MAX! Wall Thermostat+ has an internal sensor that measures the temperature in the room and cyclically transmits it to the radiator thermostats. With a MAX! Cube, the solution can be extended to a House solution.

4 DEVICE OVERVIEW

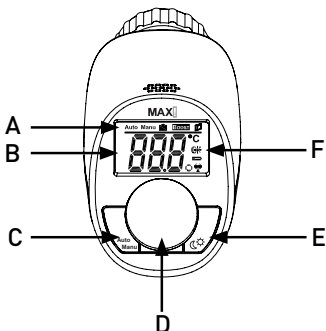

A	Automatic mode (Auto), manual mode (Manu), holiday mode (☑), boost function (BOOST), open window function (☐)
B	Display of setpoint temperature
C	Auto/Manu button, switch between automatic and manual mode, exit the holiday mode
D	Control wheel: Temperature settings, activate the boost function, confirm, start teach-in procedure
E	Switch between reduction and comfort temperature
F	Reduction/comfort temperature (☀), empty battery symbol (🔋), antenna symbol (radio synchronicity), (📶), activity symbol (🔊)

5 DISPLAY CONTENT IN NORMAL MODE

The setpoint temperature is displayed during normal operation, along with the mode. In the example, the MAX! Radiator Thermostat is in automatic mode (**Auto**) and the comfort temperature (☀) of 21.0°C is set. The antenna symbol (📶) indicates that the connection to the taught-in component has been established.



6 START-UP

6.1 INSERTING (REPLACING) BATTERIES

i In the initial state, the batteries are already inserted. Simply remove the insulation strip.

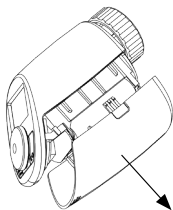

To replace the batteries, please proceed as follows:

- Press the battery compartment cover on both sides with your fingers and remove the cover by pushing it downwards.
- Insert 2 new LR6/mignon/AA (1.5 V) batteries in the battery compartment, making sure they are the right way round.





- Reattach the battery compartment cover and latch it into place.

After inserting batteries, the radiator thermostat has to be mounted on the radiator (see sec. "6.2 Installation on the radiator" on page 11). The radiator thermostat starts an adapting run afterwards (see sec. "6.3 Adaption run" on page 15).

 A battery symbol () on the display indicates that the batteries need to be replaced. After removing the empty batteries, wait approx. 1 minute before inserting the new ones.

 The service life of new alkaline batteries is approximately two years.

 Operation with rechargeable batteries is not possible.

 Never recharge standard batteries. Doing so will present a risk of explosion. Do not throw the batteries into a fire! Do not short-circuit batteries.



Never recharge standard batteries. Do not throw the batteries into a fire. Do not expose batteries to excessive heat. Do not short-circuit batteries. Doing so will present a risk of explosion.

6.2 INSTALLATION ON THE RADIATOR

The MAX! Radiator Thermostat is easy to install and can be done without draining heating water or intervening in the heating system. No special tools are required, nor does the heating have to be switched off.

The union nut attached to the radiator thermostat can be used universally and without accessories for all valves with a thread size of M30 x 1.5 from the most popular manufacturers such as

- Heimeier
- MNG
- Junkers
- Landis+Gyr (Duodyr)
- Honeywell-Braukmann
- Oventrop
- Schlösser
- Comap
- Valf Sanayii
- Mertik Maxitrol
- Watts
- Wingenroth (Wiroflex)
- R.B.M
- Tiemme
- Jaga
- Siemens
- Idmar

By means of the adapter in the delivery, the device can also be installed on radiator valves of type Danfoss RA.

6.2.1 Removing the old dial

Rotate the thermostat dial to the maximum value (1) (anti-clockwise). The thermostat dial then no longer presses against the valve spindle, making it easier to remove.

There are different ways of fixing the position of the thermostat dial:

- **Union nut:** Unscrew the union nut in an anticlockwise direction (2). The thermostat head can then be removed (3).
- **Snap-on fastenings:** Thermostat dials that have been attached using this method can be easily released by giving the lock/union nut a slight turn in the anticlockwise direction (2). The thermostat head can then be removed (3).
- **Compression fitting:** The thermostat dial is held in place by a mounting ring which is held together with a screw. Loosen this screw and remove the thermostat head from the valve (3).
- **Threaded connection with set screw:** Loosen the set screw and remove the thermostat head (3).



In case of visible damage of the existing radiator, valve or heating pipes, please consult a specialist.

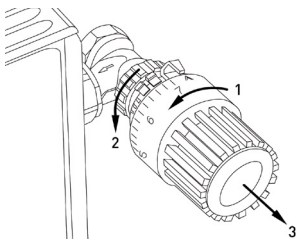

6.2.2 Danfoss RA adapter

The provided adapter is required for installation on Danfoss RA valves. The Danfoss valve bodies have elongated notches (**G**) around their circumference (see arrow), which also ensure that the adaptor is properly seated when it snaps on.



Please ensure that you do not trap your fingers between the two halves of the adapter!

During installation, please ensure that the pins inside the adapter (**H**) are lined up with the notches (**G**) on the valve. The RA adapter has been manufactured with pre-tension in order to provide a better seat. Use a screwdriver during installation if necessary, and bend it open slightly in the vicinity of the screw. Ensure that the adapter is properly clipped on. After clipping onto the valve body, please attach the adapter using the provided screw and nut.

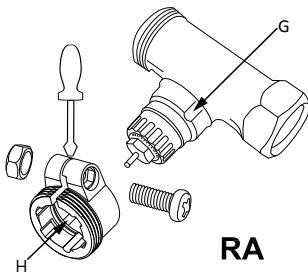

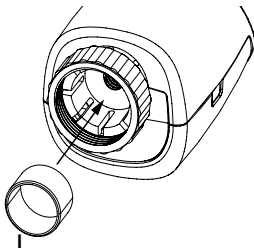

6.2.3 Support ring

The valves from different manufacturers may have tolerance fluctuations that make the radiator thermostat more loosely seated on the valve. In this case, the provided support ring (I) should be placed into the flange before mounting the radiator thermostat.



6.3 ADAPTION RUN

Once the batteries have been inserted, the motor reverses; meanwhile, "InS" and the activity symbol () are displayed. As soon as "InS" is displayed without the activity symbol () , the radiator thermostat can be mounted. This is followed by an adapting run ("AdA") to adapt the thermostat to the valve.

- Attach the radiator thermostat to the valve (see sec. "6.2 Installation on the radiator" on page 11).
- Tighten the union nut.
- Press the control wheel shortly when "InS" is displayed.

Now the radiator thermostat performs an adapting run. "AdA" and the activity symbol () are displayed; during this time, operation is not possible.

If the adapter run has been initiated prior to mounting or if an error message (F1, F2, F3) is displayed, press the control wheel; the motor reverses to the "InS" position.

 Teach-in mode can be activated even whilst "InS" is still displayed.

 If the MAX! Radiator Thermostat has not been taught-in to a MAX! Cube or Wall Thermostat+, the device automatically switches to manual operation (Manu).

7 TEACHING-IN

In order to be able to use the MAX! Radiator Thermostat in your installation, you must teach it in first. The teach-in procedure depends on the system variant used. Choose your system variant (House or Room solution) and follow the instructions below.



MAX! House solution

In the MAX! House solution all settings and programmings (e.g. week programs) can be made via the **MAX! software**.

- Put the MAX! Cube into teach-in mode. Start the local MAX! software and click on "New device" (1).
- To activate teach-in mode of the MAX! Radiator Thermostat press and hold down the control wheel for at least 3 seconds (2). The display shows the remaining teach-in time in seconds. The teach-in time is 30 seconds.

1.

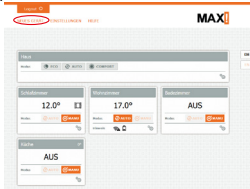

2.

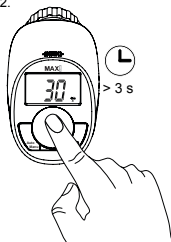

- After teaching-in has been successful, the display returns back to normal display.



As soon as the MAX! Radiator Thermostat has been taught-in to a MAX! Cube, all settings will be transmitted via radio.



The MAX! Radiator Thermostat can only be taught-in to one MAX! Cube.



If the MAX! Radiator Thermostat has already been configured via a MAX! Wall Thermostat, a factory reset has to be performed before teaching-in the device to a MAX! Cube (see sec. "13 Restore factory settings" on page 23).



MAX! Room solution

In the MAX! Room solution all settings and programmings (e.g. week programs) can be made directly via the **MAX! Wall Thermostat**.

- Press and hold down the OK button of the MAX! Wall Thermostat for at least 3 seconds to activate teach-in mode (1).
- Activate the teach-in mode of your MAX! Radiator Thermostat. Press the control wheel for at least 3 seconds. The display shows the remaining teach-in time in seconds. The teach-in time is 30 seconds.

1.

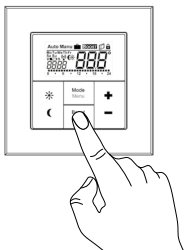

2.



After teaching-in has been successful, the display returns back to normal display.



As soon as the MAX! Radiator Thermostat has been taught-in to the MAX! Wall Thermostat, all settings such as date, time or week program will be transmitted via radio.



The MAX! Radiator Thermostat can only be taught-in to one MAX! Wall Thermostat.

8 AUTO/MANU

To switch between operating modes, press and immediately release the **Auto/Manu** button (the operating modes only become available for selection once installation is complete).

- **Auto:** Week program - automatic temperature regulation in accordance with the time profile saved (heat/reduce).



In the MAX! House solution you can individually configure your week programs via the MAX! software.



In the MAX! Room solution you can individually configure your week programs via the MAX! Wall Thermostat.

- **Manu:** Manual operation - the temperature set manually using the control wheelheel is maintained permanently.



If the operating mode is changed on one device in a room, this change is applied on all MAX! Radiator Thermostats assigned to that room.

9 BOOST

If, for example, you arrive home earlier than usual, the boost function will help you to heat the room up quickly. When activating the boost function, the heating valve is immediately opened to 80 % for 5 minutes (factory setting). The heating of a room takes longer than 5 minutes, but the heat given off by the radiator can be felt immediately.

- Press the control wheel shortly to activate the function.
- The remaining time for the function will be counted down in seconds ("b300" to "b000"). Whilst the function is active, **BOOST** is displayed.
- The activity symbol () is displayed as long as the adjusting pin opens/closes the valve.
- Once the boost time has elapsed, the radiator thermostat switches back to the mode that was active previously (Auto/Manu), with the temperature that was set previously.
- The function can be deactivated prematurely at any time by pressing the control wheel again.



The radiant heat will not have an immediate effect if the radiator is covered or concealed (e.g. by a sofa).



In the MAX! House solution you can individually configure the duration of the boost function via the MAX! software.



In the MAX! Room solution you can individually configure the duration of the boost function via the MAX! Wall Thermostat.



If the duration of the boost function is set (via the MAX! Cube or the MAX! Wall Thermostat+) so that the display exceeds 999 seconds, the display value switches from seconds to minutes.



If a long boost duration and a large valve opening have been set the radiator can get very hot. After changing the factory setting check that the radiator is not heated excessively.

10 COMFORT AND REDUCTION TEMPERATURE

The comfort and reduction temperature button () makes switching between comfort and reduction temperature simple and user friendly. The factory setting for the comfort temperature is 21.0 °C and the reduction temperature 17.0 °C.



In the MAX! House solution you can individually configure the comfort and reduction temperature via the MAX! software.



In the MAX! Room solution you can individually configure the comfort and reduction temperature via the MAX! Wall Thermostat+.

11 CHILD SAFEGUARD/OPERATING LOCK

Operation of the device can be locked to avoid settings being changed unintended (e.g. through involuntary touch).

- To activate/deactivate the operating lock, press and immediately release the **Auto/Manu** and  buttons simultaneously.
- Once the operating lock has been activated, "Loc" is displayed for 5s. After this, the temperature is displayed again.
- The operation of the MAX! Radiator Thermostat is now locked.
- To deactivate the operating lock, press both buttons once again.

12 CONFIGURATION OF THE MAX! SYSTEM



If you use the MAX! Radiator Thermostat in the MAX! House solution, you can individually change all settings of your MAX! system (e.g. configuration of week programs) via the MAX! software.



If you use the MAX! Radiator Thermostat in the MAX! Room solution, you can individually change all settings of your MAX! system (e.g. configuration of week programs) via the MAX! Wall Thermostat+.

13 RESTORE FACTORY SETTINGS



The factory settings of the MAX! Radiator Thermostat can be restored manually. Restoring the factory settings deletes all settings and information about taught-in devices.



Before restoring the factory settings of the MAX! Radiator Thermostat, first delete the device from the local MAX! software if you use the radiator thermostat in connection with a MAX! Cube.

- Remove the batteries from the MAX! Radiator Thermostat.
- Press and hold down the Auto/Manu button, the control wheel and the  button at the same time while inserting the batteries.
- Once the factory settings have been restored successfully, "rES" is displayed.

14 LED FLASHING SEQUENCES AND TRANSMISSION BEHAVIOUR

Error code on the display	Description/ problem	Solution
Battery symbol ()	Battery voltage too low	Replace batteries
F1	Valve drive sluggish	Check the installation; check whether the pin on the heating valve is stuck
F2	Actuating range too wide	Check the fastening of the actuator
F3	Adjustment range too small	Check the heating valve; check whether the valve pin is jammed
F4	Device already taught-in to a MAX! Cube or MAX! Wall Thermostat+	Make sure the device is no longer taught-in to the Cube (in the software) or the Wall Thermostat+ and perform a reset. Then you can teach-in the device again.
Slowly flashing antenna symbol ()	Connection to taught-in MAX! components lost	Check the power supply and the batteries of taught-in MAX! components
dCE + quickly flashing antenna symbol ()	Duty cycle limit reached	The device can resume radio communication after a waiting time of approx. one hour

Error code on the display	Description/ problem	Solution
LOC	Operating lock activated	Deactivate the operating lock (see sec. "11 Child safeguard/operating lock" on page 22)
CAL	Routine descaling is active	Automatic function
Battery symbol + F9	Battery voltage too low, valve moved to error position	replace batteries of radiator thermostat
Battery symbol + 10	Battery voltage much too low	replace batteries of radiator thermostat
Syn	Attempts to synchronize with known MAX! devices	/
trd	Transceiver module defect	Replace device
tSd	Temperature sensor defect or out of range	replace device or operate device in current temperature range

15 MAINTENANCE AND CLEANING



The product does not require any maintenance. Enlist the help of an expert to carry out any repairs. Clean the product using a soft, lint-free cloth that is clean and dry. You may dampen the cloth a little with lukewarm water in order to remove more stubborn marks. Do not use any detergents containing solvents, as they could corrode the plastic housing and label.

16 INFORMATION ABOUT RADIO OPERATION

Radio transmission is performed on a non-exclusive transmission path, which means that there is a possibility of interference occurring. Interference can also be caused by switching operations, electrical motors or defective electrical devices.

 The range of transmission within buildings can differ greatly from that available in the open air. Besides the transmitting power and the reception characteristics of the receiver, environmental factors such as humidity in the vicinity have an important role to play, as do on-site structural/screening conditions.

eQ-3 AG hereby declares that this device complies with the essential requirements and other relevant regulations of Directive 1999/5/EC. You can find the full declaration of conformity at www.eQ-3.de.

17 TECHNICAL DATA

Device short description:	BC-RT-TRX-CyN
Supply voltage:	2x 1.5 V LR6/mignon/AA
Current consumption:	100 mA max.
Battery life:	2 years (typ.)
Display:	LCD
Radio frequency:	868.3 MHz
Typ. open area RF range:	> 100 m
Receiver category:	SRD category 2
Duty cycle:	< 1 % per h
Method of operation:	Type 1
Degree of protection:	IP20
Degree of pollution:	2
Ambient temperature:	0 to 50 °C
Dimensions (W x H x D):	55 x 60 x 102 mm
Weight:	160 g (not incl. batteries)
Connection:	M30 x 1.5 mm
Linear travel:	4.2 mm
Spring force:	80 N (typ.)

Subject to technical changes.

Max. number of devices to be taught-in:

MAX! House solution

- max. 50 devices in max. 10 rooms,
- max. 4 MAX! Eco Switch
- per room max. 8 MAX! Radiator Thermostats⁽⁺⁾, 8 MAX! Window Sensors and 1 MAX! Wall Thermostat⁺

MAX! Room solution:

- max. 1 MAX! Wall Thermostat⁺
- max. 8 MAX! Radiator Thermostats⁽⁺⁾
- max. 8 MAX! Window Sensors



Do not dispose of the device with regular domestic waste!

Electronic equipment must be disposed of at local collection points for waste electronic equipment in compliance with the Waste Electrical and Electronic Equipment Directive.



The CE sign is a free trading sign addressed exclusively to the authorities and does not include any warranty of any properties.



For technical support, please contact your retailer.



Bevollmächtigter des Herstellers:
Manufacturer's authorised representative:

eQ-3

eQ-3 AG
Maiburger Straße 29
26789 Leer / GERMANY
www.eQ-3.de