

Oxygen meter for oxygen in gases
with integrated temperature and pressure measuring

As of Version 1.2

Operating Manual

GMH 3692



Please keep for future reference!



WEEE-Reg.-Nr. DE 93889386

Contents

1	GENERAL NOTE	2
2	DESIGNATED USE	3
3	SAFETY	3
3.1	SAFETY SIGNS AND SYMBOLS	3
3.2	SAFETY GUIDELINES	3
4	PRODUCT DESCRIPTION	4
4.1	SCOPE OF SUPPLY	4
4.2	OPERATION AND MAINTENANCE ADVICE	4
4.3	START OF OPERATION	4
4.4	ANSCHLÜSSE	5
4.5	DISPLAY ELEMENTS	5
4.6	PUSHBUTTONS	5
4.7	POP-UP CLIP	6
5	CONFIGURATION	6
6	OXYGEN MEASURING IN GASES- PLEASE NOTE	8
6.1	CHOICE OF SENSING ELEMENTS#	8
6.2	APPLICATION OF THE DIFFERENT SENSOR TYPES GGO ..., GOO ... AND GGA	8
7	CALIBRATION OF THE SENSOR	9
7.1	ONE POINT CALIBRATION (' <i>CAL 1-PT</i> ')	9
7.2	2 / 3-POINT CALIBRATION (' <i>CAL 2-PT, CAL 3-PT</i> ')	9
7.3	EVALUATION OF SENSOR STATE (<i>ELEC</i>)	9
7.4	CALIBRATION INTERVAL (<i>CalInt</i>)	10
8	INSPECTION OF THE ACCURACY / ADJUSTMENT SERVICES	10
9	SERIAL INTERFACE	10
10	ALARM („AL.“)	10
11	ERROR AND SYSTEM MESSAGES	11
12	SPECIFICATION	12
13	RESHIPMENT AND DISPOSAL	12

1 General Note

Read this document carefully and get used to the operation of the device before you use it. Keep this document within reach for consulting in case of doubt.

If the device is stored at temperatures above 50°C the battery has to be removed from the device.

NOTE: *We recommend taking out battery if device is not used for a longer period of time.*

Risk of leakage!



2 Designated Use

The GMH 3692 is measuring oxygen in air and gas mixtures either as partial pressure or as concentration in %vol.

For the measuring an external sensor of the type GOO-... or GGO... has to be connected to the MINI-DIN-socket.

Due to the properties of the sensor, it has to be calibrated regularly (e.g. at fresh air = 20.95%) to get precise values. If the sensor is used up, this will be detected during the calibration, the sensor has to be regenerated or replaced before continuing with measuring.

The safety requirements (see below) have to be observed.

The device must be used only according to its intended purpose and under suitable conditions.

Use the device carefully and according to its technical data (do not throw it, strike it, ...)

Protect the device from dirt.

3 Safety

3.1 Safety signs and symbols

Warnings are labeled in this document with the followings signs:



Caution! This symbol warns of imminent danger, death, serious injuries and significant damage to property at non-observance.



Attention! This symbol warns of possible dangers or dangerous situations which can provoke damage to the device or environment at non-observance.



Note! This symbol point out processes which can indirectly influence operation or provoke unforeseen reactions at non-observance.

3.2 Safety guidelines

This device has been designed and tested in accordance with the safety regulations for electronic devices. However, its trouble-free operation and reliability cannot be guaranteed unless the standard safety measures and special safety advises given in this manual will be adhered to when using the device.

1. Trouble-free operation and reliability of the device can only be guaranteed if the device is not subjected to any other climatic conditions than those stated under "Specification".

If the device is transported from a cold to a warm environment condensation may cause in a failure. In such case make sure the device temperature has adjusted to the ambient before trying a new start-up.

2.  If there is a risk whatsoever involved in running it, the device has to be switched off immediately and to be marked accordingly to avoid re-starting.

DANGER

Operator safety may be a risk if:

- there is visible damage to the device
- the device is not working as specified
- the device has been stored under unsuitable conditions for a longer time.

In case of doubt, please return device to manufacturer for repair or maintenance.

3.  Do not use these products as safety or emergency stop devices or in any other application where failure of the product could result in personal injury or material damage.

DANGER

Failure to comply with these instructions could result in death or serious injury and material damage.

4.  This device must not be used at potentially explosive areas! The usage of this device at potentially explosive areas increases danger of deflagration, explosion or fire due to sparking.

DANGER

4 Product Description

4.1 Scope of supply

The scope of supply includes:

- GMH 3692 with 9V-battery
- Operating manual

The necessary oxygen sensor is chosen separately due to application.

4.2 Operation and maintenance advice

1. Battery operation

If \triangle and 'bAt' are shown in the lower display the battery has been used up and needs to be replaced. However, the device will operate correctly for a certain time. If 'bAt' is shown in the upper display the voltage is too low to operate the device; the battery has been completely used up.



The battery has to be taken out, when storing device above 50 °C.

We recommend taking out battery if device is not used for a longer period of time.

After recommissioning the real-time clock has to be set again.

2. Mains operation with power supply

When using a power supply please note that operating voltage has to be 10.5 to 12 V DC.



Do not apply overvoltage!! Cheap 12V-power supplies often have excessive no-load voltage.

We, therefore, recommend using regulated voltage power supplies.

Trouble-free operation is guaranteed by our power supply GNG10/3000.

Prior to connecting the power supply to the mains make sure that the operating voltage stated at the power supply is identical to the mains voltage.

3. Treat device and sensor carefully. Use only in accordance with above specification. (do not throw, hit against etc.). Protect plug and socket from soiling.

4.3 Start of Operation

Switch the device on with the key "ON OFF". The Instrument is performing a self diagnosis, during this time all display segment are shown.

Afterwards the instrument signals, if it was user adjusted („Err“)

The device starts measurement afterwards.

4.4 Anschlüsse

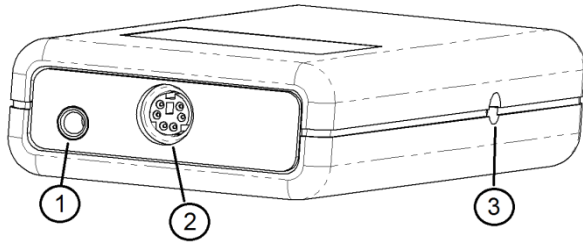

- 2. **Sensor connection** MiniDIN
- 3. **Power supply:** d.c.connector (internal pin Ø 1.9 mm) for external 10.5-12V direct voltage supply

1. **Output:** Operation as interface for the connection of galvanically isolated adapters (accessories: GRS 3100, USB 3100)

Attention: The mode of operation has to be configured (p.r.t Chapter 5) and influences the power consumption.

4.5 Display elements

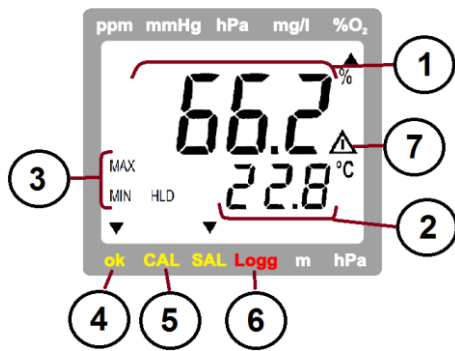

1 = **Main Display:**

Possible displays:

- Oxygen concentration in % (% O₂ Vol)
- Oxygen partialpressure (hPa or mmHg)

(change with -key)

2 = **secondary display:**

Display of sensor temperature or absolute pressure (alternating, please refer to Chapter 5. Lcd.2)

Special elements:

3 = **MIN/MAX/HLD:**

Shows, if minimum/maximum/memorized measuring value is in display
Signals, if oxygen and temperature values are stable

4 = **ok-arrow:**

Signals, if automatic calibration is in progress

5 = **CAL- arrow:**

No function

6 = **Logg - arrow**

Signals weak battery or other warning message

7 = **Warning sign:**

Die restlichen Pfeile haben in dieser Gerätevariante keine Funktion

4.6 Pushbuttons

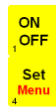

On / off key

Set/Menü

Press 2 sec.: (Menu): call configuration menu
Press shortly: Change the oxygen display unit (please refer to chapter 5)



min/max when taking measurements:

press shortly: min. or max. measured oxygen value and referring temperature and pressure values will be displayed



press for 2 sec.: the min. or max. value will be deleted



Configuration: to enter values, or change settings



Store/Enter

- Measuring: with Auto-Hold off: hold and save current measuring value ('HLD' is displayed) with Auto-Hold on: start new measuring, It is finished, when "HLD" shows in display
- Set/Menu: confirm settings, return to measuring



CAL:

- press shortly: display of sensor state rating
- press for 2 sec: start sensor calibration

4.7 Pop-up clip

Handling:

- Pull at label "open" in order to swing open the pop-up clip.
- Pull at label "open" again to swing open the pop-up clip further.

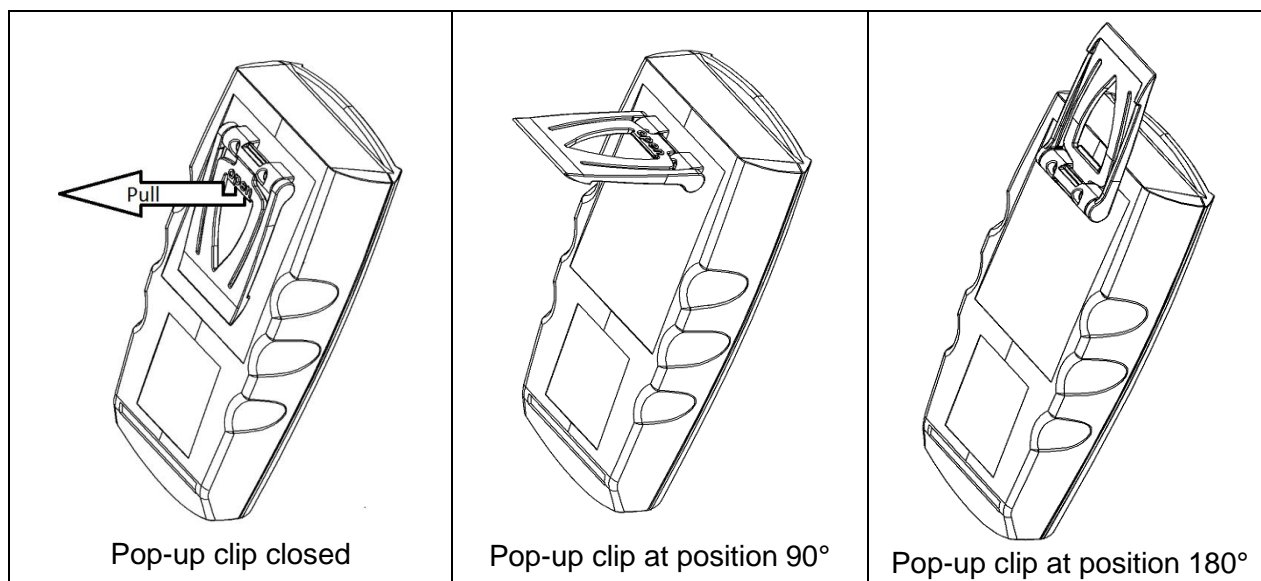

Function:



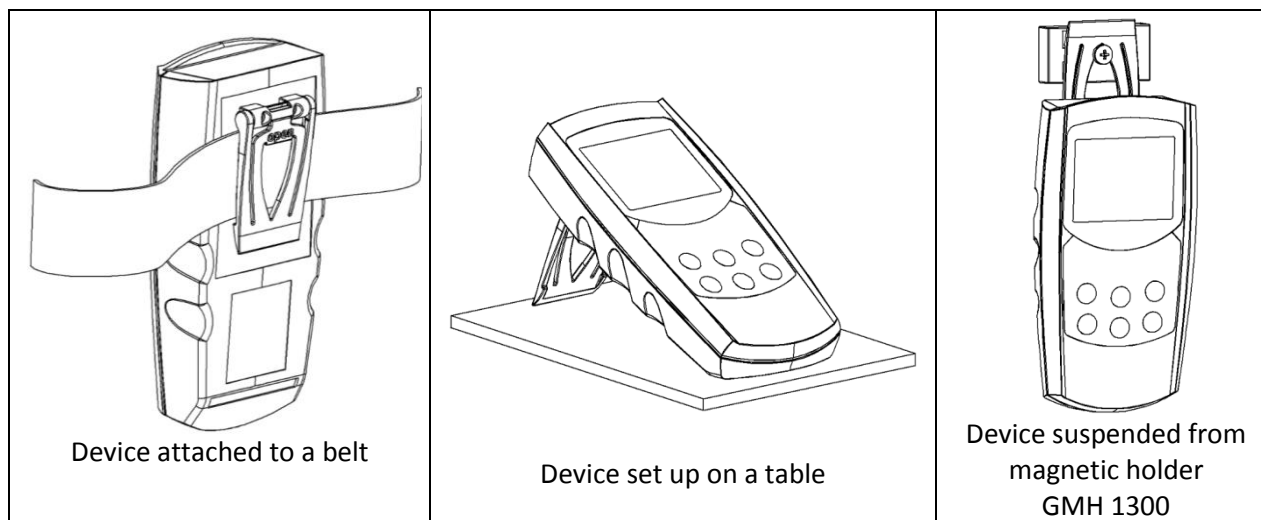

- The device with a closed pop-up clip can be plainly laid onto a table or attached to a belt, etc.
- The device with pop-up clip at position 90° can be set up on a table, etc.
- The device with pop-up clip at position 180° can be suspended from a screw or the magnetic holder GMH 1300.







5 Configuration



Some menu points depend on current device settings.

To change device settings, press „Menu“  for 2 seconds. This will activate the configuration menu (main display: "Set"). Pressing „Menu“  changes between the menus points, pressing  jumps to the referring parameters, which can be selected with key .

The parameters can be changed with  or . Pressing „Menu“  again jumps back to the main configuration menu and saves the settings. "Quit"  finishes the configuration and returns to standard measuring operation.

Menu	Parameter	Value	Description		
key Menu	key ▶	key ▲ or ▼		p.r.t	
SEt Conf	Set Configuration: General configurations				
	Ch 2	P 02	hPa	Oxygen partial pressure display in hPa	*
		P 02	mmHg	Oxygen partial pressure display in mmHg	
	Lcd.2	t		Second. display always temperature	
		P		Second. display always absolute pressure	
		P t		Second. display alternates between temperature and abs. pressure	
	Unit	t	°C	All temperatures in degree Celsius (ex works setting)	
		t	°F	All temperatures in degree Fahrenheit	
	CALP	1-Pt		Simple one point calibration at air	
		2-Pt		2 point calibration at air and 0% (e.g. N ₂) or 100 %	
		3-Pt		2 point calibration at air and 0% (e.g. N ₂) and 100 %	
	C. Int	1 ... 365		Calibration reminder period (in days)	
		oFF		No calibration reminder	
	Auto HLD	on		Auto measuring value identification Auto Hold (when logger = off)	
oFF			Standard hold function on key press (when logger = off)		
P.oFF	1 ... 120		Power-off delay in minutes. Device will be automatically switched off as soon as this time has elapsed if no key is pressed/no interface communication takes place. (ex works setting 20min)		
	oFF		Automatic power-off function deactivated (continuous operation)		
Adr		01, 11, 21, ... 91	Base address for serial interface communication (ex works setting 01)		
SEt Corr	Set Corr: Input adjustment				
	OFFS °C or °F	-5.0 °C .. 5.0 °C or. -9.0 °F .. 9.0 °F		The zero point of the temperature measuring is shifted for the entered value. This can be used to compensate sensor and instrument deviations	
		oFF		No zero adjustment for temperature measurement (=0.0°)	
		SCAL °C or °F	-5.00 ... 5.00 %		The slope of the temperature measurement is corrected by this value. This can be used to compensate sensor and instrument deviations
	oFF		No slope adjustment for temperature measurement (=0.00)		
	OFFS hPa	-20 .. 20 hPa		The zero point of the pressure measuring is shifted for the entered value. This can be used to compensate sensor deviations	
oFF			No zero adjustment for pressure measurement (=0.0°)		
SEt AL	Set Alarm: Einstellung der Alarmfunktion				
	AL. 1	on / no.5o		Messkanal Sauerstoff: Alarm an mit Hupe / Alarm an ohne Hupe	
		oFF		keine Alarmfunktion für Messkanal Sauerstoff	
	AL. n	Conc		Alarmkanal Sauerstoff: Konzentration in %	
		P.02		Alarmkanal Sauerstoff: Partialdruck in hPa oder mmHg	
	ALLo		z.B. 0.0..100.0 %	Min-Alarm-Grenze Sauerstoff (nicht bei AL. 1. oFF)	
	ALh _i		z.B. 0.0..100.0 %	Max-Alarm-Grenze Sauerstoff (nicht bei AL. 1. oFF)	
	AL. 2	on / no.5o		Alarm Temperaturmessung an mit Hupe / Alarm an ohne Hupe	
oFF			keine Alarmfunktion für Temperaturmessung		
ALLo		-5.0 ..+ 50.0 °C	Min-Alarm-Grenze Temperatur (nicht bei AL. 2. oFF)		
ALh _i		-5.0 ..+ 50.0 °C	Max-Alarm-Grenze Temperatur (nicht bei AL. 2. oFF)		



Pressing "menu" and "store" at the same time for more than 2 seconds will reset the device to factory defaults

If no key is pressed within 2 minutes the configuration will be aborted. All changes will not be saved!

6 Oxygen Measuring in Gases- Please Note

The GMH 369x is designed for measuring the oxygen partial pressure or the oxygen concentration (%vol, calculated from partial pressure and ambient pressure) in gases. Please keep in mind:

- **The sensor has to be calibrated regularly, e.g. at fresh ambient air**
- **The calibration and the measuring are pressure depending!**
The instrument automatically measures the ambient pressure, be sure, that the instrument's pressure is the same like the pressure at the sensor's membrane. For the full automatic compensation a precision pressure sensor is integrated in the instrument.
- **The sensor temperature has to be the same like the gas temperature!**
*Temperature differences may falsify the results!
Please have in mind that temperature adoption of the sensor and the air may take several hours.
A suitable ventilation or gasflow around the sensor would speed up this process significantly.*

The sensor consists of a sensing element (GOEL xxx) enclosed in a sensor housing (GGO/ GGA/GOO). When purchasing a Sensor GGO/GGA/GOO xxx, a sensor element is already integrated, e.g. a GGO 370: contains housing GGO and a sensor element GOEL 370.

6.1 Choice of Sensing Elements#

GOEL 370:

Universal sensor element with special protection measures especially for diving application ("Nitrox"). Very long life time, also suitable for application with larger CO₂ concentrations.

GOEL 380:

Fast responding for low oxygen concentration e.g. protection atmosphere below 1%, max 25%. For application without larger CO₂ concentration.



Sensors are not allowed to be used in „under-Water-Diving-Application (e.g. Rebreather)

DANGER

6.2 Application of the different sensor types GGO ..., GOO ... and GGA

GGO (closed sensor)



For measurements at atmosphere and in systems without over or under pressure the GGO... is sufficient. Additionally the GGO can be screwed tightly into systems with small over or under pressure. Attention! Mind the maximum pressure and the maximum pressure difference at the membrane. If instrument and sensor pressure are different, it will be compensated wrong!

GOO 370 / 380 (open sensor)



The sensor is equipped with drillings at the end and because of its special construction the measuring gas streams optimally around the sensor. No pressure can appear while gas blows to the sensor, which otherwise would result in erroneous measures. The temperature compensation speed of the sensor also is optimised by this design.

Especially the measuring of gases from compressed gas bottles, where the expansion of the gas leaving the bottle lowers the temperature, is optimised with regard to the temperature compensation and pressure errors. The gas flow should be chosen in a suitable range, where no overpressure can happen, esp. if the sensor is connected directly to the source e.g. by means of a tube.

GGA (closed sensor with pressure port)

Not suitable for GMH 3692

7 Calibration of the Sensor

In order to compensate for ageing of the sensor, the sensor has to be calibrated at regular intervals. The device is equipped with an easy-to-use calibration functions. We recommend to calibrate the sensor at least all 7 days, or to get maximum precision, before each measuring series.

7.1 One Point Calibration ('CAL 1-Pt')

The calibration adjusts the sensor to the oxygen content of the atmosphere (20.95%). Therefore simply expose the sensor to the ambient air (sufficient ventilation in closed rooms has to be ensured)

Start calibration: press -key for 2 seconds

The display will show 'Pt. 1' and as soon the values for oxygen and temperature are stable, the calibration will be finished

Then the electrode state resulting of the successful calibration will be shown for a short time (evaluation in 10% steps: xx% ELEC).

7.2 2 / 3-Point Calibration ('CAL 2-Pt, CAL 3-Pt')

The sensor will be automatically calibrated to the oxygen content of the atmosphere (20.95%) and one or two additional concentrations. As reference gases usually Nitrogen (0% vol O₂) or pure oxygen are used

1. **Start calibration: press -key for 2 seconds**
2. **First calibration reference: (Pt.1)**

As first reference at a 3-point calibration, the zero reference has to be applied (NULL), at a 2-point calibration either 100% or 0%(NULL).

The display will show 'Pt. 1', and the referring reference which should be applied:

- NULL for 0% oxygen
- 0.2 for pure oxygen

As long as the display blinks, no valid reference is recognised by the instrument.

As soon the values for oxygen and temperature are stable, the calibration of the first point will be finished. The instrument tells you to apply the next reference (possible references are blinking in the display).

3. **Second calibration reference: (Pt.2)**

The display will show 'Pt. 2', and the referring reference which should be applied:

- Pt. 1 for ambient air
- 0.2 for pure oxygen
- NULL for 0% oxygen

As long as the display blinks, no valid reference is recognised by the instrument.

As soon the values for oxygen and temperature are stable, the calibration of the second point will be finished. At 2-point calibration the calibration will be finished and the electrode state resulting of the successful calibration will be shown for a short time (evaluation in 10% steps: xx% ELEC).

At 3-point calibration the instrument tells you to apply the next reference (possible reference is blinking)

4. **Third calibration reference: (Pt.3)**

The display will show 'Pt. 3', and the referring reference which should be applied:

As soon the values for oxygen and temperature are stable, the calibration of the second point will be finished. At 2-point calibration the calibration will be finished and the sensor state resulting of the successful calibration will be shown for a short time (evaluation in 10% steps: xx% ELEC).



In case of error messages being displayed during the calibration process, please refer to our notes at the end of this manual! If a calibration cannot be carried out after an extended period of time, at least one of the measuring values is unstable (oxygen partial pressure, temperature).

Please check your measuring arrangements!

7.3 Evaluation of Sensor State (ELEC)

Watch sensor state: press key "CAL" shortly oncedisplay show for a short time xx% ELEC.

It will show the electrode state resulting of the last successful calibration carried out.

The valuation is displayed in 10 percent steps: 100% means optimal sensor condition. Lower values are indicating that the sensor life time will be reached soon.

Remark: But also an erroneous pressure may be the cause of low valuation values.

7.4 Calibration Interval (CAL)

You can enter the interval after which the device reminds you to recalibrate in the configuration. The interval times should be chosen according to the application and the stability of the sensor. "CAL" flashes on the display as soon as the interval has expired.

8 Inspection of the accuracy / Adjustment Services

The instrument can be sent to the manufacturer for adjustment and function test. Only the manufacturer can check all systems on correct them if necessary.

Calibration certificates – DKD-certificates – other certificates:

If device should be certificated for its accuracy, it is the best solution to return it to the manufacturer. (please specify references, e.g. 20.9 and 100%).

If the instrument is certified with its sensor, this proves for example the linearity of the measuring chain, regular recalibration by the user is still necessary!

9 Serial Interface

With an electrically isolated interface converter USB3100, GRS3100 or GRS3105 (accessory) the device can be connected to a PC.

With the GRS3105 it is possible to connect up to 5 instruments of the GMH3000 family to a single interface (please also refer to GRS3105-manual). As a precondition the base addresses of all devices must not be identical, make sure to configure the base addresses accordingly (refer menu point "Adr." in chapter 5). In order to avoid transmission errors, there are several security checks implemented (e.g. CRC).

The following standard software packages are available for data transfer:

- **GSOFT3050:** Operating and evaluation software for instruments with integrated logger function
- **EBS20M/ -60M:** 20- / 60-channel software to record and display the measuring values
- **GMHKonfig:** Software for a comfortable configuration of the device (e.g. freeware)

In case you want to develop your own software we offer a **GMH3000-development package** including

- an universally applicable 32bit Windows functions library ('GMH3000.DLL') with documentation that can be used by all 'serious' programming languages.
- Programming examples for Visual Studio 2010 (C#, C++), Visual Basic 6.0™, Delphi 1.0™, Testpoint™, Labview™

The Device has 4 Channels:

- oxygen concentration % Vol
- oxygen partial pressure in hPa or mmHg
- temperature value at the time of recording in °C or °F
- absolute pressure in hPa abs or mmHg abs

Supported Interface-functions:

1	2	3	4	Code	Name/Function	1	2	3	4	Code	Name/Function
x	x	x	x	0	read nominal value	x	x	x	x	199	read measuring type in display
x	x	x	x	3	read system status	x	x	x	x	200	read min. display range
x				12	read ID-no.	x	x	x	x	201	read max. display range
x	x	x		22	read min alarm limit	x	x	x	x	202	read unit of display
x	x	x		23	read max alarm limit	x	x	x	x	204	read decimal point of display
x	x	x	x	176	read min measuring range	x				208	read channel count
x	x	x	x	177	read max measuring range	x				222	read turn-off-delay
x	x	x	x	178	read measuring range unit	x				223	Set turn-off-delay
x	x	x	x	179	read measuring range decimal point	x				240	Reset
x	x	x	x	180	read measuring type	x				254	read program identification



The measuring and range values read via interface are always in the selected display unit!

10 Alarm („AL.“)

There are three possible settings:





Alarm off (AL. oFF), on with buzzer (AL. on), on without buzzer (AL. no.So).

Following conditions will display an alarm, when the function is activated (on or no.So):

- Value is below lower (AL. Lo) or above upper alarm rail (AL.Hi).
- Sensor error
- Low battery (bAt)
- Err.7: System error (always with buzzer)

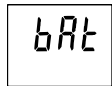
In case of an alarm and when polling the interface the "prio"-flag is set in the returned message.

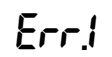





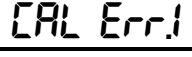

11 Error and System Messages

Display	Meaning	Remedy
	low battery voltage, device will continue to work for a short time	replace battery
	If mains operation: wrong voltage	replace power supply, if fault continues to exist: device damaged
	low battery voltage	replace battery
	If mains operation: wrong voltage	Check/replace power supply, if fault continues to exist: device damaged
No display or weird display Device does not react on keys	low battery voltage	replace battery
	If mains operation: wrong voltage	check/replace power supply, if fault continues to exist: device damaged
	system error	disconnect battery or power supply, wait some time, re-connect
	device defective	return to manufacturer for repair
	sensor error: no sensor cable connected	connect suitable sensor
	Sensor, cable or instrument defect	return to manufacturer for repair
	Value exceeding measuring range	Check: Is the value exceeding the measuring range specified? ->value too high!
	Wrong sensor connected	Check sensor
	Sensor, cable or instrument defect	return to manufacturer for repair
	Value below display range	Check: Is the value below the measuring range specified? ->value too low!
	Wrong sensor connected	Check sensor
	Sensor, cable or instrument defect	return to manufacturer for repair
	system error	return to manufacturer for repair

If “**bAt**” is flashing, the battery will be exhausted soon. Further measurements are possible for short time.

If “**bAt**” is displayed continuously the battery is ultimately exhausted and has to be replaced. Further measurements aren't possible any more.

Messages During Calibration/Adjustment

	either preset calibration interval has expired or last calibration is not valid	device has to be calibrated!
	wrong reference point at air	check sensor and reference gas
	slope too low	
	reference gas wrong sensor element is defect	check sensor and reference gas replace sensor element
	slope too high	
	reference gas wrong sensor element is defect	check sensor and reference gas replace sensor element
	incorrect calibration temperature	calibration can only be done at 0...50 °C
	Zero value to low/negative	
	sensor element is defect	replace sensor element
	zero value to high	
	reference gas wrong sensor element is defect	check sensor and reference gas replace sensor element
	incorrect calibration pressure	check calibration pressure
	signal not stable / timeout	check sensor and reference gas
	sensor not known: cannot be calibrated	check sensor and wiring

12 Specification

Measuring ranges	Oxygen concentration	0.0 ... 100.0 % O ₂ (Vol)	electrochemical sensors GGO / GOO
	Oxygen partial pressure	0 ... 1100 hPa O ₂	“ “ “
	Sensor temperature	-5.0 ... + 50.0 °C	NTC 10k (integr. in GGO / GOO cable)
	Absolute pressure	10 ... 1200 hPa abs.	integrated pressure sensor
Accuracy (instrument without sensor, at 25°C, 1000 hPa abs)	Oxygen concentration	±0.1 % O ₂ (Vol)	
	Oxygen partial pressure	± 1 hPa	
	Sensor temperature	± 0.1 °C	
Accuracy	Absolute pressure	3 hPa or 0.1% of measured value (the higher one to be applied)	
Working conditions	-20 ... 50 °C; 0 ... 95 % r.H. (not condensing)		
Nom. temperature	25°C		
Storage temp.	-20 ... 70 °C		
Connections	O ₂ & temperature	6 pole Mini-DIN Socket	
	Interface /	serial, (3.5mm audio plug), via isolated adapter GRS3100, GRS3105 or USB3100 (accessories) for PC-USB or RS232- connection	
	external supply	d.c. connector (diameter of internal pin 1.9 mm) for external 10.5-12V direct voltage supply. (suitable power supply: GNG10/3000)	
Display	4 digit 7-segment 2 lines, additional segments		
Calibration	automatic	1 -, 2- or 3-point calibration, 0%, 100% or ambient air (20.95%)	
GLP	adjustable calibration intervals (1 to 365 days, CAL warning after expiration)		
Alarm	Buzzer / visual / interface 2 channels: selectable oxygen unit and temperature		
Additional functions	Min / max / hold / auto hold		
Housing	Break-proof ABS housing		
	Protection class	Front side IP65	
	Dimensions L*B*H [mm] Weight	Without pressure port: 142 x 71 x 26 mm (L x B x H) approx. 160 g (incl. battery)	
Power supply	9V-Battery, Type IEC 6F22 (in scope of supply) or external supply		
Current consumption	Ca. 0.6 mA (if Out = Off ca. 0.4mA)		
Change battery indicator	Automatic at weak battery  and ' bAt '		
Auto-Off-Function	Device will be automatically switched off if no key is pressed/no interface communication takes place for the time of the power-off delay. The power-off delay can be set to values between 1 and 120 min.; it can be completely deactivated.		
EMI	The device corresponds to the essential protection ratings established in the Regulations of the Council for the Approximation of Legislation for the member countries regarding electromagnetic compatibility (2004/108/EG). Additional fault: <1%		

13 Reshipment and Disposal



Dispense exhausted batteries at destined gathering places.

This device must not be disposed as “residual waste”. To dispose this device, please send it directly to us (adequately stamped). We will dispose it appropriately and environmentally friendly.



All devices returned to the manufacturer have to be free of any residual of measuring media and other hazardous substances. Measuring residuals at housing or sensor may be a risk for persons or environment

DANGER



Use an adequate transport package for reshipment, especially for fully functional devices. Please make sure that the device is protected in the package by enough packing materials.