

# CAN@net II

Intelligent PC/CAN Interface

**USER MANUAL**  
ENGLISH



## **HMS Technology Center Ravensburg GmbH**

Helmut-Vetter-Straße 2  
88213 Ravensburg  
Germany

Tel.: +49 751 56146-0

Fax: +49 751 56146-29

Internet: [www.hms-networks.de](http://www.hms-networks.de)

E-Mail: [info-ravensburg@hms-networks.de](mailto:info-ravensburg@hms-networks.de)

## **Support**

For problems or support with this product or other HMS products please request support at [www.ixxat.com/support](http://www.ixxat.com/support).

Further international support contacts can be found on our webpage [www.ixxat.com](http://www.ixxat.com)

## **Copyright**

Duplication (copying, printing, microfilm or other forms) and the electronic distribution of this document is only allowed with explicit permission of HMS Technology Center Ravensburg GmbH. HMS Technology Center Ravensburg GmbH reserves the right to change technical data without prior announcement. The general business conditions and the regulations of the license agreement do apply. All rights are reserved.

## **Registered trademarks**

All trademarks mentioned in this document and where applicable third party registered are absolutely subject to the conditions of each valid label right and the rights of particular registered proprietor. The absence of identification of a trademark does not automatically mean that it is not protected by trademark law.

Document number: 4.01.0086.20000

Version: 2.0

---

<b>1</b>	<b>Introduction .....</b>	<b>5</b>
1.1	<b>Overview .....</b>	<b>5</b>
1.2	<b>Features .....</b>	<b>5</b>
1.3	<b>Support .....</b>	<b>6</b>
1.4	<b>Returning Hardware .....</b>	<b>6</b>
<b>2</b>	<b>Installation .....</b>	<b>7</b>
2.1	<b>Software Installation .....</b>	<b>7</b>
2.2	<b>Hardware Installation .....</b>	<b>7</b>
<b>3</b>	<b>Connections and Indicators .....</b>	<b>8</b>
<b>3.1</b>	<b>Pin Allocation .....</b>	<b>8</b>
3.1.1	Power Connector .....	8
3.1.2	Ethernet Socket.....	9
3.1.3	CAN Bus Connector.....	10
<b>3.2</b>	<b>Indicators.....</b>	<b>10</b>
3.2.1	Power LED (PWR) .....	11
3.2.2	Status LED (CPU).....	11
3.2.3	Ethernet LED (ETH).....	12
3.2.4	Collision LED (COL).....	12
3.2.5	Link/Data Activity LED (ACT).....	13
3.2.6	CAN LED (CAN).....	13
<b>3.3</b>	<b>CAN Bus Termination .....</b>	<b>14</b>
<b>4</b>	<b>Configuration.....</b>	<b>14</b>
<b>4.1</b>	<b>Configuration Tool .....</b>	<b>14</b>
4.1.1	Overview .....	14
4.1.2	Usage.....	15
<b>4.2</b>	<b>Resetting the Network Parameters .....</b>	<b>15</b>
<b>5</b>	<b>Appendix.....</b>	<b>17</b>
<b>5.1</b>	<b>Technical specifications .....</b>	<b>17</b>
<b>5.2</b>	<b>Default Network Settings .....</b>	<b>18</b>
<b>5.3</b>	<b>Windows Firewall Settings .....</b>	<b>19</b>
5.3.1	CAN@net II/VCI.....	19
5.3.2	CAN@net II/Generic .....	19
<b>5.4</b>	<b>Accessories .....</b>	<b>20</b>
5.4.1	CAN Bus Termination Resistor .....	20

**5.5 Notes on EMC..... 21**  
**5.6 Declaration of Conformity ..... 21**  
**FCC Compliance..... 22**

# 1 Introduction

## 1.1 Overview

This manual is intended to familiarize you with the device. Please read this manual before beginning with the installation.

For miscellaneous applications HMS offers different versions of the CAN@net II.

As a TCP/IP based PC/CAN interface for standard Windows applications the **CAN@net II/VCI** is the best choice. It offers with the Ixxat standard Windows driver interface VCI an easy to handle and wide functional interface for Windows applications. The Ixxat tools also use this standard driver interface.

The **CAN@net II/Generic** offers with a generic ASCII interface via TCP/IP the possibility to use the device in non-Windows systems such as Linux operating systems. Additionally, two CAN@net II/Generic devices can be used as a bridge. This makes it possible to connect two CAN networks which are far away from each other via TCP/IP. The CAN@net II/Generic devices receive the CAN messages of their CAN network and transmit them via TCP/IP to the other CAN@net II/Generic device. Filters can be set on configuration of the bridge, so only messages which are interesting for the other network are exchanged.

For the different CAN@net II versions, specific manuals are available. This manual describes the software installation and the programming and integration of the devices into customer applications.

## 1.2 Features

- power supply range +9 V to +32 V DC
- Freescale 32 Bit microcontroller with 150 MHz clock
- 8 MByte DRAM
- 4 MByte flash
- 1 CAN Controller PHILIPS SJA1000 with 16 MHz clock
- CAN bus interface according to ISO 11898-2, galvanically isolated
- Ethernet PHY with Auto Crossover
- 10BASE-T/100BASE-TX Ethernet

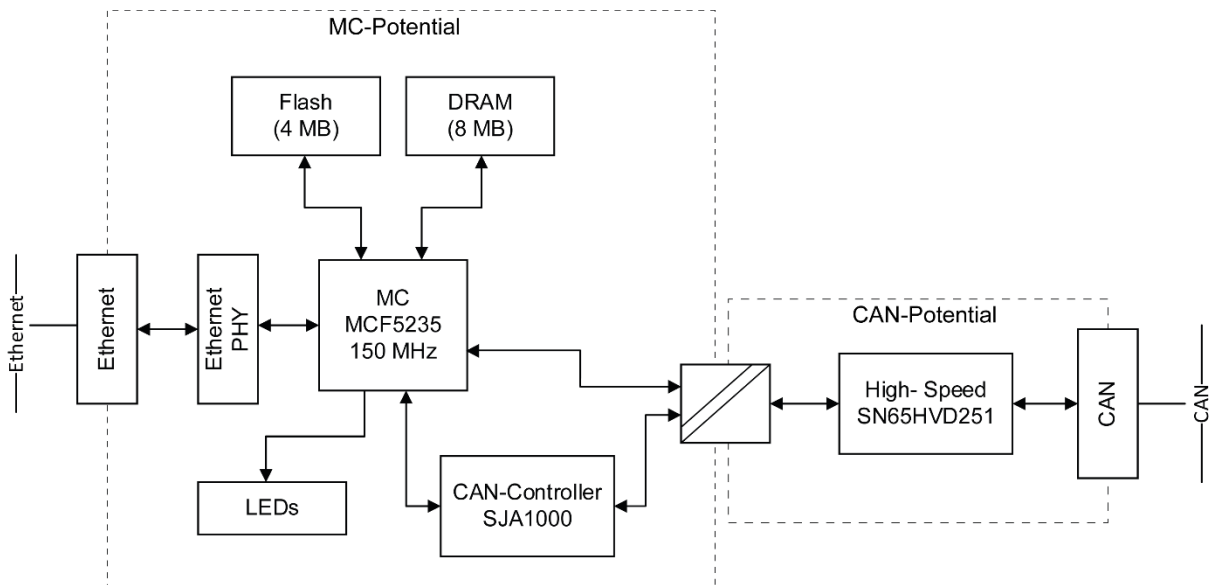

Picture 1-1: Block diagram of the CAN@net II

### 1.3 Support

For more information on our products, FAQ lists and installation tips, please refer to the support section of our website ([www.ixxat.com](http://www.ixxat.com)), which also contains information on current product versions and available updates.

If you have any further questions after studying the information on our website and the manuals, please contact our support department. The support section on our website contains the relevant forms for your support request. In order to facilitate our support work and enable a fast response, please provide precise information on the individual points and describe your question or problem in detail.

If you would prefer to contact our support department by phone, please also send a support request via our website first, so that our support department has the relevant information available.

### 1.4 Returning Hardware

If it is necessary to return hardware to us, please download the relevant RMA form from our homepage and follow the instructions on this form. In the case of repairs, please also describe the problem or fault in detail on the RMA form. This will enable us to carry out the repair quickly.

## **2 Installation**

### **2.1 Software Installation**

To operate the CAN@net II/VCI interface, a driver is required. This driver is part of the VCI (Virtual CAN Interface), which can be downloaded for free from the HMS website ([www.ixxat.com](http://www.ixxat.com)).

For the installation of the CAN driver VCI under Windows, please refer to the VCI installation manual.

For the CAN@net II/Generic bridge mode, the devices must be configured. This is described in detail in the CAN@net II/Generic manual.

### **2.2 Hardware Installation**

The CAN@net II device needs a power supply and an Ethernet connection. There is no further hardware installation necessary.

The CAN@net II can be plugged and unplugged during operation of the PC (hot-plug compatible).

It is recommended to install the VCI software before plugging in for the first time.

## 3 Connections and Indicators

### 3.1 Pin Allocation

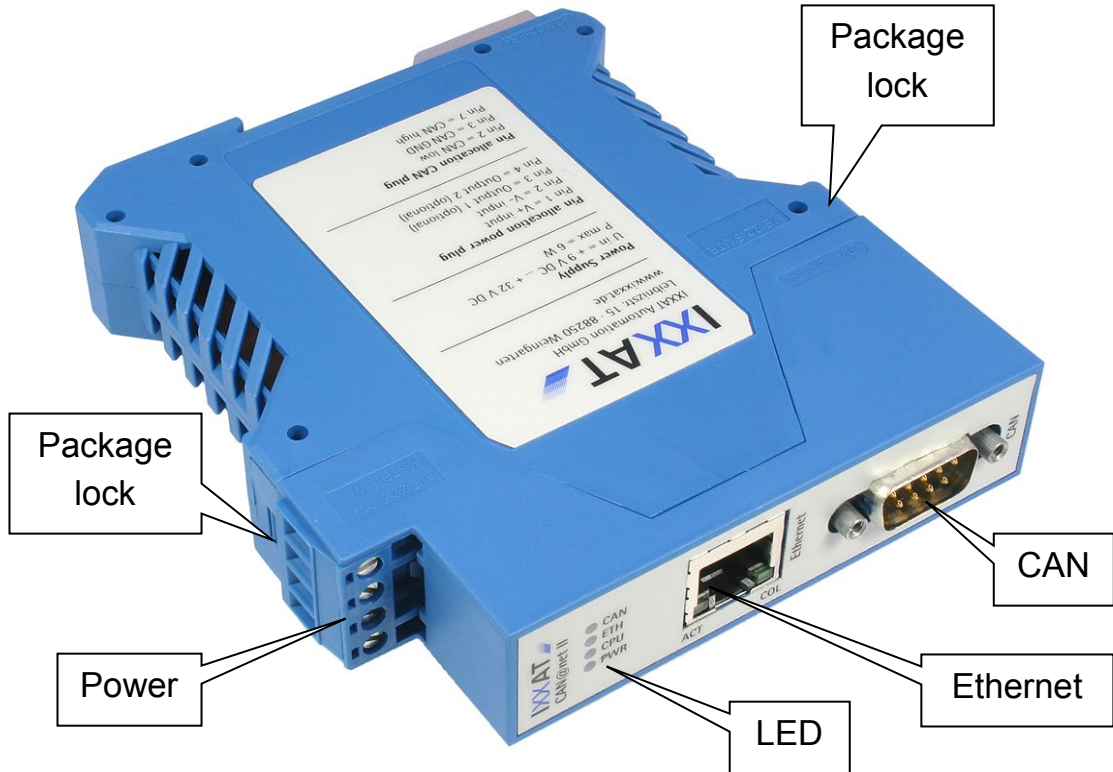

Picture 3-1: Connectors and indicators of the CAN@net II

#### 3.1.1 Power Connector

For the power connection of the CAN@net II, a screw terminal is used. For wiring, please ensure that the cross-sectional area of the cable is larger than or equal to 0.14 mm<sup>2</sup>.

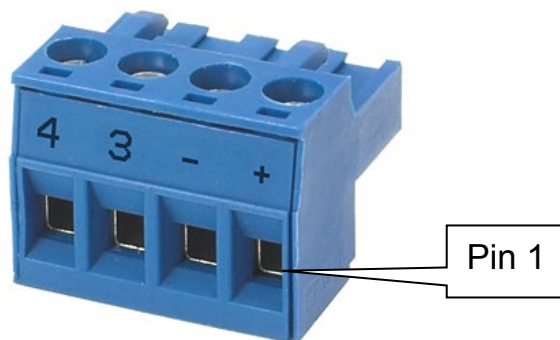

Picture 3-2: Power connector of the CAN@net II



Pin No.	Signal
1	V+ (+9 V to +32 V DC)
2	V-
3	Output 1 (optional)
4	Output 2 (optional)

---

**Table 3-1: Pin allocation of the power connector**

The power connector is just plugged into the housing and can be removed with a screwdriver or similar tool.

### 3.1.2 Ethernet Socket

The Ethernet socket is designed as a standard RJ45 socket. The pin allocation is according to the Ethernet standard. The Ethernet PHY has an auto-crossover feature, so the CAN@net II can be connected with a crossover cable or with a 1-to-1 network cable.

Pin No. RJ45	Signal
1	TX +
2	TX -
3	RX +
4	Connected to pin 5
5	Connected to pin 4
6	RX -
7	Connected to pin 8
8	Connected to pin 7

---

**Table 3-2: Pin allocation of the Ethernet socket**

The shield of the socket is connected to the ground of the printed board via a 1 nF capacitor.

### 3.1.3 CAN Bus Connector

The CAN@net II has a CAN bus interface according to ISO 11898-2. The signals of the CAN bus interface are connected to the Sub D-9 plug (see table 3-3).

Pin No. Sub D9	Signal
1	Not connected
2	CAN low
3	GND
4	Not connected
5	Not connected
6	Not connected
7	CAN high
9	Not connected
9	Not connected

Table 3-3: Pin allocation of the CAN bus connector

The shield of the CAN connector is connected to the ground of the CAN bus interface via a 1 MΩ resistor and a 1 nF capacitor.

For best noise immunity results, the shields of the CAN cables have to be grounded.

### 3.2 Indicators

The CAN@net II has six LEDs. The LEDs show the communication status of the relevant interface or the device status.

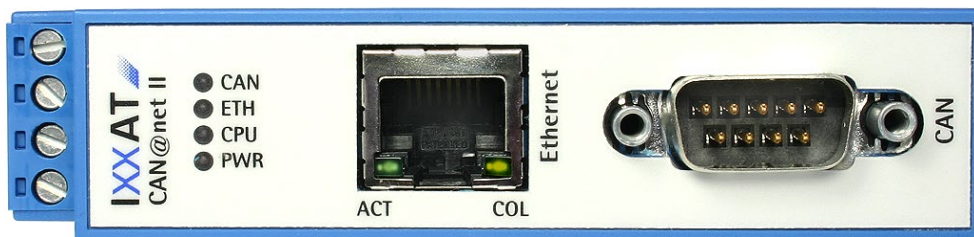

Picture 3-3: LEDs of the CAN@net II

### 3.2.1 Power LED (PWR)

The Power LED indicates the status of the power supply. If the LED is green, the power supply is working. If the LED is off, there is a problem with the power supply.

Flashing mode	Description	Causes/Hints
Off	No power	<ul style="list-style-type: none"> <li>• Device not connected to a power supply</li> <li>• Fuse of the device damaged</li> <li>• Internal power supply damaged</li> </ul>
Green	Power ok	<ul style="list-style-type: none"> <li>• Device fully functional</li> </ul>

Table 3-4: States of the Power LED

### 3.2.2 Status LED (CPU)

The two-color (green and red) LED indicates the CAN@net II device status.

Flashing mode	Description	Causes/Hints
Off	Device not ready	<ul style="list-style-type: none"> <li>• Boot manager or application firmware is not starting</li> </ul>
Green blinking (1 Hz)	Application firmware started	<ul style="list-style-type: none"> <li>• Application signals “normal” operating</li> </ul>
Green blinking (2 Hz)	Boot manager active	<ul style="list-style-type: none"> <li>• Boot manager of the device is running</li> <li>• No application on the device or the application is still not running</li> </ul>
Red	Write access to flash device	<ul style="list-style-type: none"> <li>• An application is written to the flash device</li> <li>• A configuration is written to the flash device</li> </ul>
Red blinking	Device error	<ul style="list-style-type: none"> <li>• Application or boot manager signals a device error</li> </ul>

Table 3-5: States of the Status LED

### 3.2.3 Ethernet LED (ETH)

The two-color (green and red) LED for Ethernet indicates the Ethernet communication status of the CAN@net II. For each successfully transmitted TCP/IP packet, the LED flashes green. In the case of a transmission error, the LED flashes red.

Flashing mode	Description	Causes/Hints
Off	No Ethernet communication possible	<ul style="list-style-type: none"> <li>• Device unsuccessfully initialized</li> <li>• Device not connected to Ethernet</li> <li>• No communication</li> </ul>
Green/Green blinking	TCP/IP packet(s) transmitted successfully	<ul style="list-style-type: none"> <li>• Communication present and successful</li> </ul>
Red/Red blinking	TCP/IP packet(s) not transmitted	<ul style="list-style-type: none"> <li>• TCP/IP communication not established, the cable may be damaged or no network connection</li> </ul>

Table 3-6: States of the Ethernet LED

### 3.2.4 Collision LED (COL)

The yellow LED flashes with each collision detected within the Ethernet traffic.

Flashing mode	Description	Causes/Hints
Off	No collisions	<ul style="list-style-type: none"> <li>• No collisions in the Ethernet traffic</li> </ul>
Yellow/Yellow blinking	Collision(s) detected	<ul style="list-style-type: none"> <li>• Collisions in the network traffic detected.</li> </ul>

Table 3-7: States of the Collision LED

### 3.2.5 Link/Data Activity LED (ACT)

The green LED shows the connection status of the Ethernet interface.

Flashing mode	Description	Causes/Hints
Off	No Link detected.	<ul style="list-style-type: none"> <li>• No connection to an Ethernet network</li> <li>• Network cable damaged</li> </ul>
Green	Ethernet Link detected, but no communication	<ul style="list-style-type: none"> <li>• Network connection ok, but no network traffic at the moment</li> </ul>
Green/Green blinking	Ethernet communication	<ul style="list-style-type: none"> <li>• Network traffic detected</li> </ul>

Table 3-8: States of the Link/Data Activity LED

### 3.2.6 CAN LED (CAN)

The two-color (green and red) LED for CAN flashes on each CAN message (transmitted or received) green, if there was no error detected.

If the CAN controller is in the “Error warning” or “Error passive” state, the LED flashes red on each message. In the “Bus off” state the LED is continuously red.

Flashing mode	Description	Causes/Hints
Off	No CAN communication	<ul style="list-style-type: none"> <li>• No CAN communication</li> <li>• Device not connected to CAN</li> </ul>
Green/Green blinking	CAN communication	<ul style="list-style-type: none"> <li>• With each CAN message the LED is triggered</li> </ul>
Red blinking	CAN communication, CAN controller in error state	<ul style="list-style-type: none"> <li>• CAN controller is in the “Error Warning” or “Error passive” state, the reception/transmission of CAN messages is still possible</li> </ul>
Red	Bus Off	<ul style="list-style-type: none"> <li>• CAN controller is in “Bus Off” state, no CAN communication possible</li> </ul>

Table 3-9: States of the CAN LED

### 3.3 CAN Bus Termination

There is **no** bus termination resistor for the CAN bus assembled on the CAN@net II.

As an accessory a bus termination resistor is available as a feed through connector at HMS (ordering number 1.04.0075.03000).

## 4 Configuration

### 4.1 Configuration Tool

#### 4.1.1 Overview

The configuration tool, which is installed automatically with the VCI, is used to set the network parameters of the CAN@net II.

The tool scans the network for CAN@net II devices. The detected devices are shown in the “Device List” and can be configured separately.

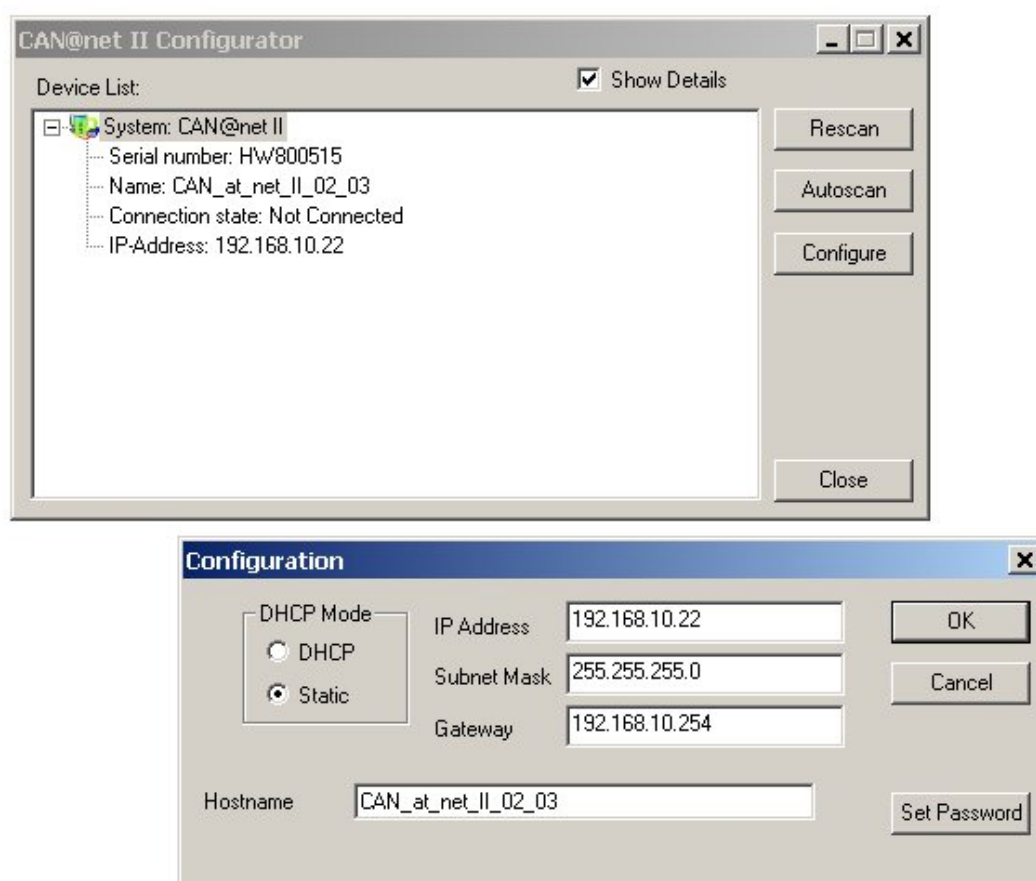

Picture 4-1: Configuration tool

### 4.1.2 Usage

When the configuration tool is started, the network is scanned for CAN@net II devices. If a device is connected to the network later, there are two possibilities for detecting the new device:

- activating the function “Autoscan”, so that the tool scans the network every 3 seconds, or
- pushing the “Rescan” button for a single network scan.

For configuring the network parameters of a CAN@net II, the desired device has to be chosen from the “Device List”. After that, the “Configure” button has to be pushed. This is only possible if the device is not connected to another application (Connection State: Not Connected).

In the configuration dialog, the DHCP mode can be activated or deactivated. The IP address, the subnet mask and the gateway can only be set in the non-DHCP mode. In addition, the hostname and the password can be set.

When “OK” is clicked, the parameters are written to the CAN@net II. For successful operation, the password has to be entered. The configuration can be stopped with “Cancel”.

The default settings of the network parameters are shown in the appendix.

### 4.2 Resetting the Network Parameters

The default settings of the network parameters can be reloaded using the DIP switch.

The following steps are necessary:

- (1) Ensure that you are electro-statically discharged.
- (2) Switch off the CAN@net II and unplug the power connector.
- (3) Separate the top housing (incl. printed board) from the bottom housing. For this, the two package locks have to be pressed in slightly.
- (4) Switch number 1 of the DIP switch to “ON”.
- (5) Put the printed board back in the bottom housing. Pay attention to the ESD plastic film, because it has to be assembled.
- (6) Connect the CAN@net II to the power supply. A green and red running light has to be displayed by the LEDs PWR, CPU, ETH and CAN.
- (7) Disconnect the CAN@net II from the power supply.
- (8) Remove the PCB from the bottom housing in a similar way to the steps described above.
- (9) Switch number 1 of the DIP switch back to “Off”.
- (10) Put the printed board including the ESD plastic film back in the bottom housing. Ensure that the package lock is active again.

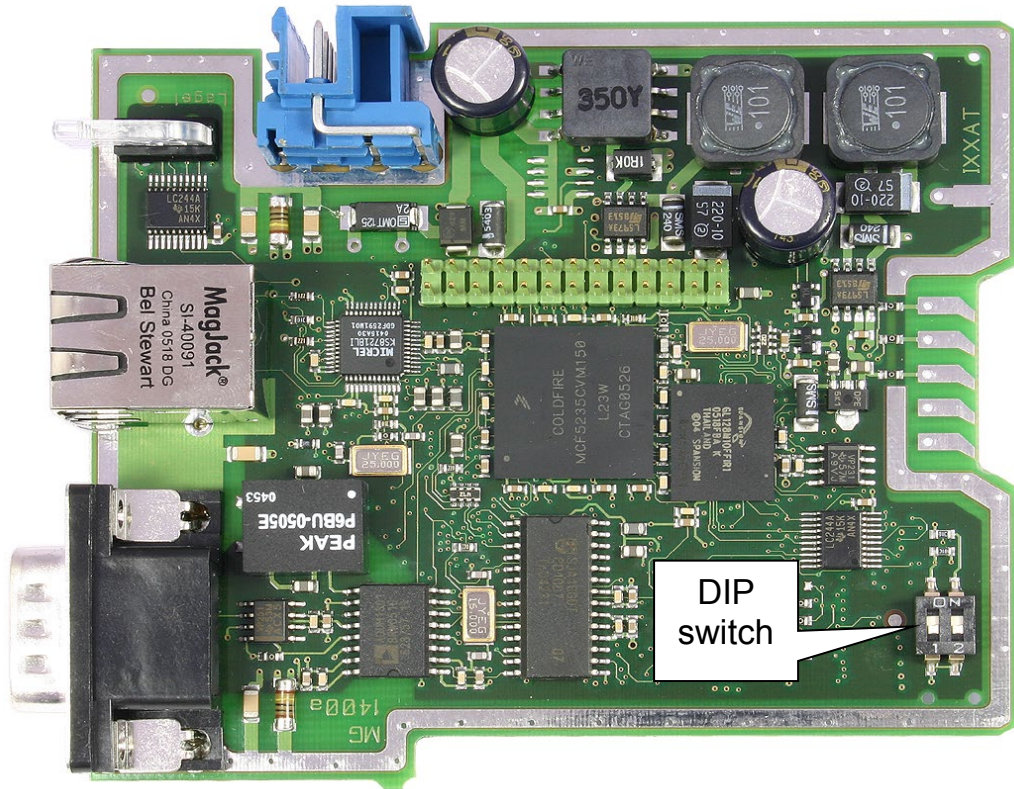

Picture 4-2: Position of the DIP switch

Switch	Position	Signal
1	Off	Normal usage (default setting)
	On	Resetting of the network parameters to the default settings
2	Off	Unused (default setting)
	On	Unused

Table 4-1: Functions of the DIP switch



## 5 Appendix

### 5.1 Technical specifications

Ethernet interface:	10/100 MBit, twisted pair
Microcontroller:	Freescale MCF5235, 150 MHz
RAM / Flash:	8 MByte SDRAM / 4 MByte
CAN controller:	internal and 1x Philips SJA1000T
CAN transceiver:	Texas Instruments SN65HVD251P
Max. number of CAN bus nodes:	120
CAN bus termination resistor:	none
CAN propagation delay:	with galvanic isolation typically 32 ns
CAN baudrates:	10 kBaud to 1 MBaud
Max. CAN message rate (with VCI, receive direction):	21000 messages/s (continuous) 21000 messages /s (burst)
Max. CAN- message rate (with VCI, transmit direction):	7200 messages /s (continuous)
Power supply:	+9 V to +32 V DC
Power consumption (normal):	typically 110 mA (at 24 V input voltage) maximum 250 mA (at 24 V input voltage)
Housing material:	Polyamide
Dimensions (L x B x H) in mm:	114.5 x 99 x 22.5
Weight:	approx. 300 g
Protection class:	IP30
Operating temperature range:	-20 °C to +70 °C
Storage temperature range:	-40 °C to +85 °C
Relative humidity:	10 to 95 %, non-condensing
Galvanic isolation:	500 V AC for 1 min
Environmental directive:	RoHS, WEEE, directive (2002/95/EC)

## 5.2 Default Network Settings

Network Parameter	Default Setting	Remark
DHCP	Active	
IP address	169. 254. (BYTE)(Serial no. – 800000)/254). (BYTE)(Serial no. – 800000)%254 + 1)	Like APIPA if no DHCP server is available
Subnet mask	255.255.0.0	
Gateway address	0.0.0.0	
Host name	CAN_at_net_II_ 4. byte of MAC address as hex- value_ 5. byte of MAC address as hex- value	
Password	IXXAT	Transmitted MD5-encrypted

**Table 5-1: Default Network Settings**

## 5.3 Windows Firewall Settings

The application and the configurator must be able to communicate through the firewall of the local PC. When the application or the configurator are run the first time, the operation system asks for permission to communicate through the firewall. To assign the permission to the application and the configurator, local administrator rights are necessary.

Another way to set the permission is via the Control Panel. Go to **Control Panel – System and Security – Windows Defender Firewall – Allowed apps**, select the application or the configurator and make the appropriate settings. To avoid the blocking of CAN@net II Configurator by the Windows Firewall, the following settings must be ensured.

### 5.3.1 CAN@net II/VCI

#### Configuration Connection:

- CAN@net II/VCI: 15000/udp
- PC: 15001/udp

#### VCI Connection:

- CAN@net II/VCI: 15000/tcp, 15001/tcp
- PC: 1024-65535/tcp

The PC must get access to the ports 15000/tcp and 15001/tcp of the CAN@net II/VCI from any port (1024-65535). From its ports 15000/tcp and 15001/tcp the CAN@net II must get access to the PC ports 1024-65535.

### 5.3.2 CAN@net II/Generic

The CAN@net II/Generic uses the port 19227/tcp. The PC must get access to the port 19227/tcp of the CAN@net II from any port (1024-65535). From its port 19227/tcp the CAN@net II must get access to the PC ports 1024-65535.

## 5.4 Accessories

### 5.4.1 CAN Bus Termination Resistor

HMS offers a bus terminal resistor as a feed through connector (order number 1.04.0075.03000).

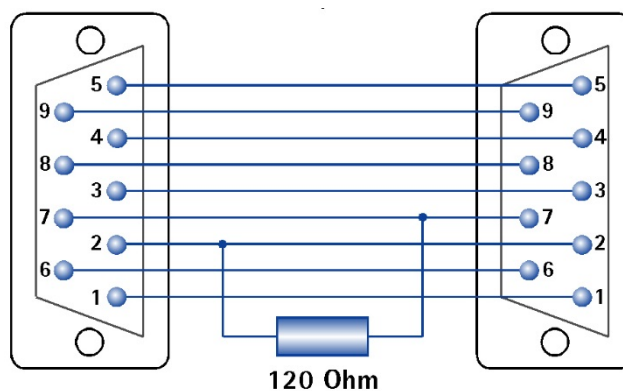

Picture 5-1: Connections of the CAN bus terminal resistor



Picture 5-2: CAN bus termination resistor

### **5.5 Notes on EMC**

The PC/CAN-Interface CAN@net II may only be used with a PC that has a CE-symbol. The CAN-bus connected to the interface must have a shielded lead. The shield braiding must be connected with low impedance to the connector housing.

### **5.6 Declaration of Conformity**

This product is in compliance with the Electromagnetic Compatibility Directive. More information about the Declaration of Conformity can be found at [www.ixxat.com](http://www.ixxat.com).

## **FCC Compliance**

### **Declaration of Conformity**

This device complies with Part 15 of the FCC Rules. Operation is subject to the following two conditions:

- this device may not cause harmful interference, and
- this device must accept any interference received, including interference that may cause undesired operation.

### **Class A Digital Device Instructions**

Note: This equipment has been tested and found to comply with the limits for a Class A digital device, pursuant to Part 15 of the FCC Rules. These limits are designed to provide reasonable protection against harmful interference when the equipment is operated in a commercial environment. This equipment generates, uses and can radiate radio frequency energy and, if not installed and used in accordance with the instruction manual, may cause harmful interference to radio communications. Operation of this equipment in a residential area is likely to cause harmful interference, in which case the user will be required to correct the interference at his own expense.