

4. Control diagram using External Digital Start Input.

4.1.1 If Start type $\overline{b-k-b}$ is selected as $\overline{b-v-p}$.

4.1.1.1 If Downcount $\overline{b-cc-b}$ =1 and $\overline{b-ut-p}$ is $\overline{b-n}$ the control diagram is shown in Figure 4.1

4.1.2 If Downcount $\overline{b-cc-b}$ =1 and $\overline{b-ut-p}$ is $\overline{b-ff}$ the control diagram is shown in Figure 4.2

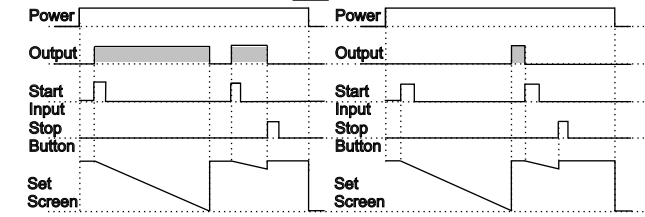

Figure 4.1

Figure 4.2

4.2.1.1 If Upcount $\overline{b-cc-b}$ =0 and $\overline{b-ut-p}$ is $\overline{b-n}$ the control diagram is shown in Figure 4.3

4.2.2.1 If Upcount $\overline{b-cc-b}$ =0 and $\overline{b-ut-p}$ is $\overline{b-ff}$ the control diagram is shown in Figure 4.4

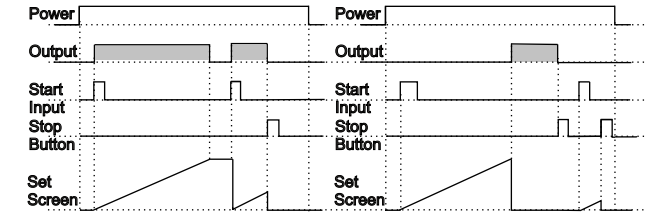
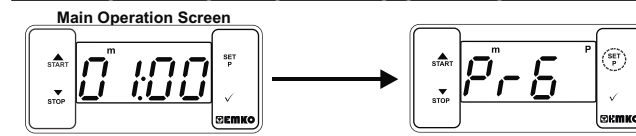

Figure 4.3

Figure 4.4

6.5 Entering To The Programming Mode, Changing and Saving Parameter



When SET button is pressed for 5 seconds, "P" led starts to blink. If programming mode entering password is different from 0, $\overline{b-5-5-5}$ Temperature Unit screen is observed instead of programming screen $\overline{b-5-5-5}$ will be observed.

Note1: If programming mode accessing password is 0, $\overline{b-5-5-5}$ Temperature Unit screen is observed instead of programming screen $\overline{b-5-5-5}$ will be observed.

Programming Mode Entering Screen
Press SET button for accessing to the password entering screen.



Password Entering Screen
Enter programming mode accessing password with increment and decrement buttons.

Password Entering Screen
Press OK button for entering the password.

Note2: If programming mode accessing password is 0, only three parameters are accessible, and the parameter values can be changed.



Filter Time of Start Input
Press SET button for accessing to the parameter value. Press increment button for accessing to the next parameter, press decrement button for accessing to the previous parameter.

Filter Time of Start Input
Change the value with increment and decrement buttons.



Filter Time of Start Input
Press OK button for saving the parameter.

Filter Time of Start Input
Press increment button for accessing to the next parameter, press decrement button for accessing to the previous parameter.

i If no operation is performed in programming mode for 20 seconds, device turns to main operation screen automatically.

EMKO

Digital Timer Controller



EZM-3735 77 x 35 DIN Size Digital Timer Controller

- 4 Digits Display
- Operation with One Set value
- Single Contact Output for Timing control (ON / OFF)
- External Start Input
- Start and Stop Possibility by front Panel
- Set value high limit boundaries
- Display can be adjusted to show Second, Minute and Hour
- Programmable Time Bases (Second, Minute, Hour)
- Adjustable internal buzzer according to Timer Stop status.
- Password protection for programming section
- Having CE mark according to European Norms

Instruction Manual. ENG EZM-3735 01 V00 07/13

1. Preface

EZM-3735 Programmable Timer can be used in package machines, production and quality control rollers, and can be adapted easily to all mechanical construction and automation system. Some application fields which they are used are below:

Application Fields
Package machines,
Quality Control rollers,
Filling Systems,
Tool Benches,
Building Automation,
Production bands

1.1 Environmental Ratings

- Operating Temperature** : 0 to 50 °C
- Max. Operating Humidity** : 90% Rh (non-condensing)
- Altitude** : Up to 2000 m.
- Forbidden Conditions:**
Corrosive atmosphere
Explosive atmosphere
Home applications (The unit is only for industrial applications)

1.2 General Specifications

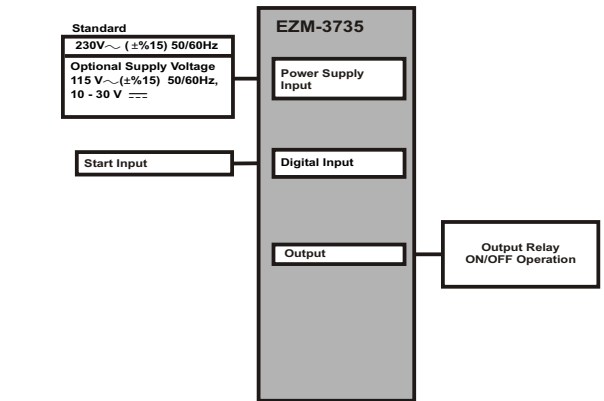

7. Specifications

Device Type	: Digital Timer
Housing & Mounting	: 76mm x 34.5mm x 71mm plastic housing for panel Mounting. Panel cut-out is 71x29mm.
Protection Class	: NEMA 4X (Ip65 at front, Ip20 at rear).
Weight	: Approximately 0.20 Kg.
Environmental Ratings	: Standard, indoor at an altitude of less than 2000 meters with none condensing humidity.
Storage / Operating Temperature	: -40 °C to +80 °C / -30 °C to +80 °C
Storage / Operating Humidity	: 90 % max. (None condensing)
Installation	: Fixed installation
Overvoltage Category	: II.
Pollution Degree	: II, office or workplace, none conductive pollution
Operating Conditions	: Continuous
Supply Voltage and Power	: 230V~ (±%15) 50/60Hz - 1.5VA : 115V~ (±%15) 50/60Hz - 1.5VA
Time Accuracy	: within ±%1 error
Digital Input	: Mechanical contact
Control Form	: ON / OFF
Relay Output	: 16(8) A@250 V ~ for Resistive load (Output Relay) (Electrical life : 100.000 switching at full load)
Display	: 14 mm Red 4 digits LED Display
LED	: S (Green), P (Green), h (Red), m(Red),s (Red), Output (Red)
Internal Buzzer	: 83dB
Approvals	: GOST-R, CE

8. Ordering Information

EZM-3735 (77x35 DIN Sizes)		A	B	C	D	E	/	F	G	H	I	/	U	V	W	Z
		5	0	0	1	/	00	00	/	0	0	0	0	0	0	0
A	Supply Voltage															
4	115V~ (±%15) 50/60Hz - 1.5VA															
5	230V~ (±%15) 50/60Hz - 1.5VA															
8	10 - 30 V ---															
E	Output															
1	Relay Output (16(8) A@250 V ~,at resistive Load, 1 NO+NC)															

All order information of EZM-3735 Digital Timer are given on the table at above. User may form appropriate device configuration from information and codes that at the table and convert it to the ordering codes. Firstly, supply voltage then other specifications must be determined. Please fill the order code blanks according to your needs.

Please contact us, if your needs are out of the standards.

~ Vac,
- Vdc
--- Vdc or Vac can be applied

1.3 Installation

A visual inspection of this product for possible damage occurred during shipment is recommended before installation. It is your responsibility to ensure that qualified mechanical and electrical technicians install this product.

If there is danger of serious accident resulting from a failure or defect in this unit, power off the system and separate the electrical connection of the device from the system.

The unit is normally supplied without a power supply switch or a fuse. Use power switch and fuse as required.

Be sure to use the rated power supply voltage to protect the unit against damage and to prevent failure.

Keep the power off until all of the wiring is completed so that electric shock and trouble with the unit can be prevented.

Never attempt to disassemble, modify or repair this unit. Tampering with the unit may result in malfunction, electric shock or fire.

Do not use the unit in combustible or explosive gaseous atmospheres.

During putting equipment in hole on the metal panel while mechanical installation some metal burrs can cause injury on hands, you must be careful.

Montage of the product on a system must be done with it's fixing clamps. Do not do the montage of the device with inappropriate fixing clamp. Be sure that device will not fall while doing the montage.

It is your responsibility if this equipment is used in a manner not specified in this instruction manual.

1.4 Warranty

EMKO Elektronik warrants that the equipment delivered is free from defects in material and workmanship. This warranty is provided for a period of two years. The warranty period starts from the delivery date. This warranty is in force if duty and responsibilities which are determined in warranty document and instruction manual performs by the customer completely.

1.5 Maintenance

Repairs should only be performed by trained and specialized personnel. Cut power to the device before accessing internal parts. Do not clean the case with hydrocarbon-based solvents (Petrol, Trichlorethylene etc.). Use of these solvents can reduce the mechanical reliability of the device. Use a cloth dampened in ethyl alcohol or water to clean the external plastic case.

1.6 Manufacturer Company

Manufacturer Information:
Emko Elektronik Sanayi ve Ticaret A.Ş.
Demirtaş Organize Sanayi Bölgesi Karanfil Sk. No:6 16369 BURSA/TURKEY
Phone : +90 224 261 1900
Fax : +90 224 261 1912

Repair and maintenance service information:
Emko Elektronik Sanayi ve Ticaret A.Ş.
Demirtaş Organize Sanayi Bölgesi Karanfil Sk. No:6 16369 BURSA/TURKEY
Phone : +90 224 261 1900
Fax : +90 224 261 1912

2. General Description

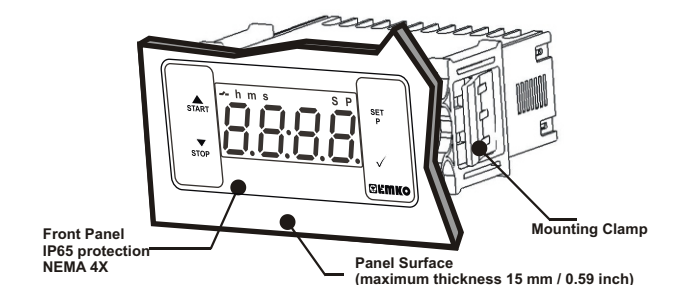

2.1 Front View and Dimensions of EZM-3735 Digital Timer

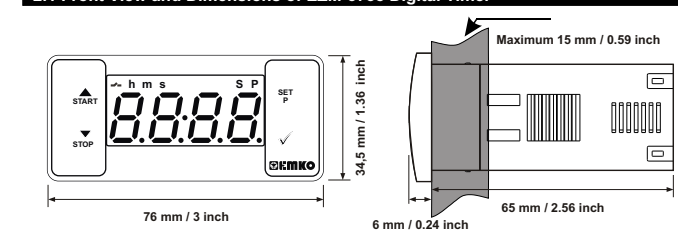

2.2 Panel Cut-Out

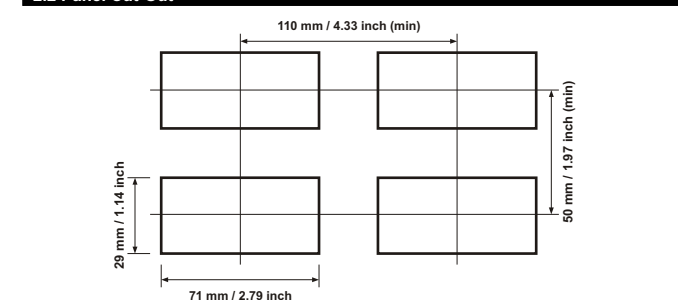

EMKO Thank you very much for your preference to use Emko Elektronik products, please visit our Your Technology Partner web page to download detailed user manual. www.emkoelektronik.com.tr

2.3 Panel Mounting

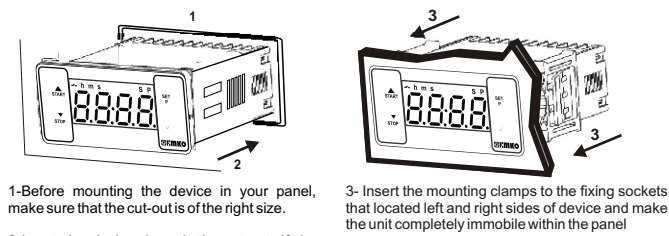

- 1- Before mounting the device in your panel, make sure that the cut-out of the right size.
- 2- Insert the device through the cut-out. If the mounting clamps are on the unit, put them before inserting the unit to the panel.
- 3- Insert the mounting clamps to the fixing sockets that located left and right sides of device and make the unit completely immobile within the panel

2.4 Removing from the Panel

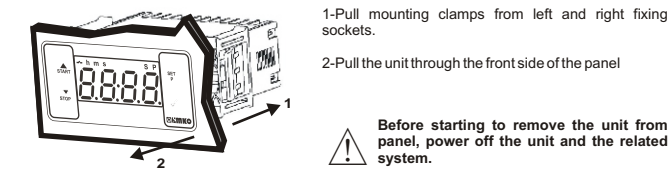

1-Pull mounting clamps from left and right fixing sockets.
2-Pull the unit through the front side of the panel

Before starting to remove the unit from panel, power off the unit and the related system.

4. Electrical Wiring Diagram

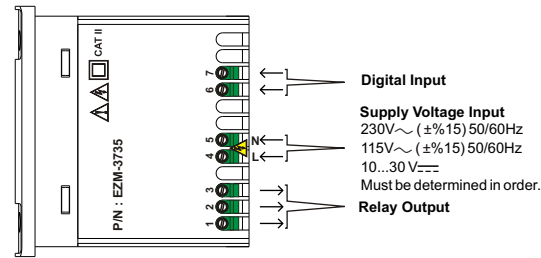

Digital Input

Supply Voltage Input
230V~ (±15%) 50/60Hz
115V~ (±15%) 50/60Hz
10...30 V=

Relay Output

4.1 Supply Voltage Input Connection of the Device

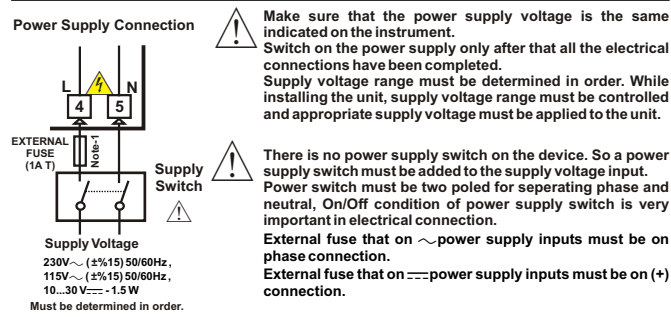

Note-1 : External fuse is recommended.

4.2 Device Label and Connection Diagram

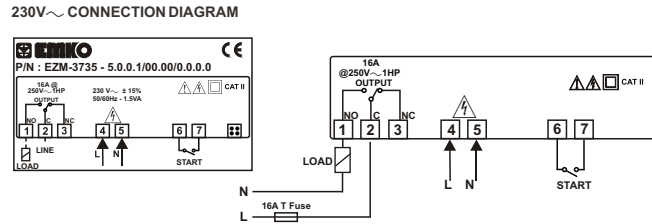

5. Front Panel Definition and Accessing to the Menus

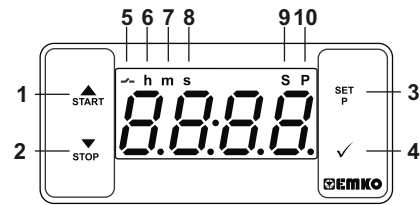

BUTTON DEFINITIONS

1. Increment Button and Start Button :

- ** It is used to increase the value in the Set screen and Programming mode.
- ** It is used for Start the Timer in the Main Screen.

2. Decrement, Silencing Buzzer and Stop Button :

- ** It is used to decrease the value in the Set screen and Programming mode.
- ** It is used to silence the buzzer.
- ** It is used for Stop the Timer in the Main Screen.

3. Set Button and Programming Button:

- ** In the main operation screen; if this button pressed, set value will be displayed. Value can be changed using increment and decrement buttons. When Enter button pressed, value is saved and returns back to main operating screen.
- ** To access the programming screen; in the main operation screen, press this button for 5 seconds.

4. Enter Button:

- ** It is used to saving value in the Set screen and programming screen.

LED DEFINITIONS

5. Output led :

- ** This led indicates that Output is active.

6. Hour led :

- ** Indicates that device is in Hour mode.

7. Minute led :

- ** Indicates that device is in Minute mode.

8. Second led :

- ** Indicates that device is in Second mode.

9. Set led :

- ** Indicates that device is in Set value changing mode.

10. Program led :

- ** Blinks in programming mode.

6. Changing and Saving Timing Set Value

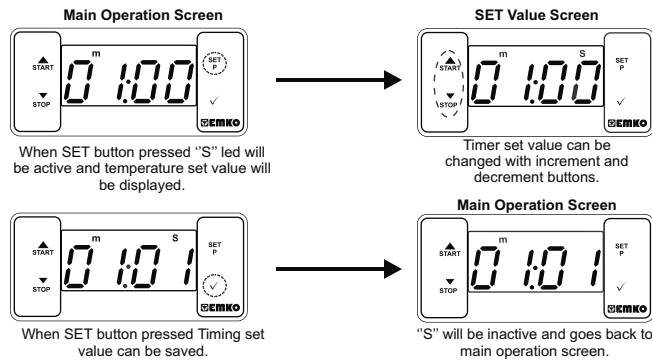

Timer set value parameter (Default=01:00)
Timer set value, can be programmed between minimum Timer set value 00:01 and UPL maximum set limit.

6.1 Programming Mode Parameter List

- rStF** Filter Time of Start Inputs (Default = 100)
It is used for protection against the electrical contact debounce or the signal that is less than the determined pulse time.
It can be adjusted from 2 to 250 msec.
- tUnit** Time Unit and Scale Selection Parameter (Default = 1)
hour Hour / Minute
It can be adjusted from 000 to 9999.
min Minute / Second
It can be adjusted from 000 to 9999.
Sec Second / 10 Millisecond
It can be adjusted from 000 to 9999
- StCrT** Start Type Selection Parameter (Default = EYP0)
EYP0 Start / Stop buttons can be used to run or stop the timer.
EYP1 Start / Stop buttons can be used to run or stop the timer.
EYP2 External Start Input can be used to run or stop the timer.
EYP3 External Start Input can only be used to run the timer. In order to stop the timer the Stop button must be used.
For detailed information refer to graphics.
- outF** Output Functions (Default = bFF)
b-n if ON is selected timer runs by start and relay contact is closed. When time is over, relay contact opens.
bFF if OFF is selected timer runs by start. When time is over, relay contact is closed.

- buF** Buzzer Function Selection Parameter (Default = 0)
If this parameter is selected 0, Buzzer is inactive. Adjustable 16 different buzzer sounds. It can be adjusted from 0 to 16.
- bon** Buzzer is active during this time (Default = - - -)
Buzzer stays active during this time. It can be adjusted from 1 to 99 seconds. When this parameter is 1, if decrement button is pressed, - - - is observed. In this condition buzzer is active till buzzer Stop button is pressed.
- drEc** Data Record (Default = 1)
0 Timer count value is saved to memory when power is disconnected and restored on power up.
1 Timer count value is not saved to memory when power is disconnected. When power up, Set value is shown on the screen.
- outL** Output Relay On Delay Time (Default = 0)
It determines how long output relay will be active. If it is 0000 second, then it operates indefinitely. It can be adjusted from 0000 to 9999 minute/second. This parameter is active only if outF = bFF.
- UPL** Maximum Set Value Parameter (Default = 01:00)
Maximum set value for set time value.
It can be adjusted from 000 to 9999. (If time value is monitored in milliseconds, Sec)
It can be adjusted from 000 to 9999. (If time value is monitored in Hours, hour or Minutes, min)
- dEcT** Timer Counting Direction (Default = 1)
0 Timer upcount. 0 to Set value.
1 Timer Downcount. Set value to 0.
- Prt** Button Protection Parameter (Default = 0)
0 Button protection is not active.
1 Button protection is active for Timer set value.
- PAS** Programming Section Access Password (Default = 0)
It is used for accessing to the programming section. It can be adjusted from 0 to 9999. If it is selected 0, password will not be asked.

6.3 Operation Graphics of ESM-3735 Digital Timer

1. Control diagram using Start / Stop buttons.

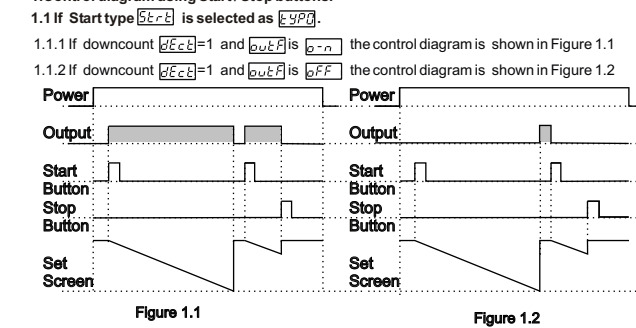

1.2 If Start type StCrT is selected as EYP0.

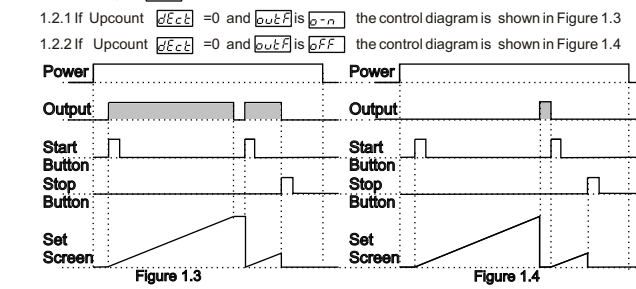

2. Control diagram using Start / Stop buttons.

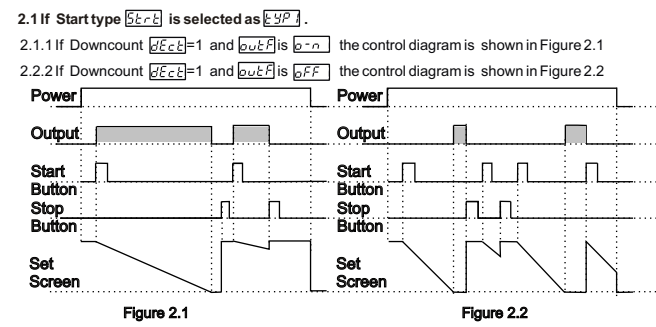

1.4 If Start type StCrT is selected as EYP1.

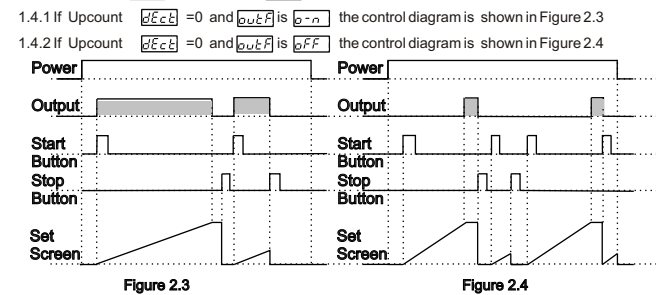

3. Control diagram using External Digital Start Input.

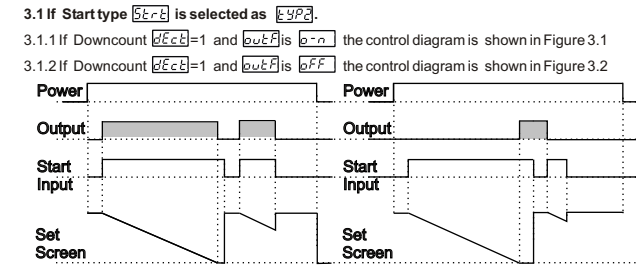

3.2.1 If Upcount dEcT = 0 and outF is b-n

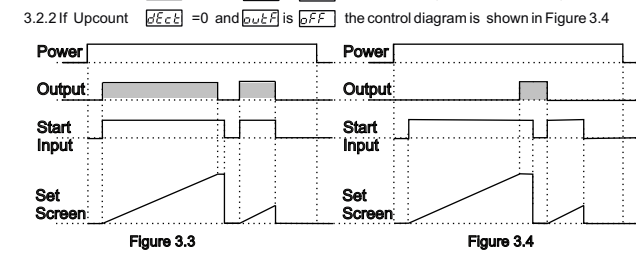

3.2.2 If Upcount dEcT = 0 and outF is bFF

