



JUMO DICON touch Two-Channel Process and Program Controller with Paperless Recorder and Touchscreen

Brief description

The DICON touch is a two-channel universal process and program controller that displays information on a vibrant screen. The device is easy to operate via a touchscreen. Both control channels use the tried-and-tested JUMO control algorithm with two possible optimization options. These enable a simple and highly-accurate startup. It also enables multiple zone control, cascade control, or other complex control tasks.

The block diagram below illustrates the various different hardware options offered by the modular hardware concept. Four analog universal inputs and up to eight external inputs can record a variety of physical measured values with high precision. The actuators can be controlled directly in the device with either an analog or digital setup. These can be expanded further through external digital outputs. Interfaces such as Modbus (master/slave), PROFIBUS, or Ethernet with Web server can be used for the communication with higher-order systems.

To ensure secure process operation, the device has a password-protected user administration with individual assignment of rights for different levels or control commands. Screen masks for controllers, program generators, recording, and for overview screens are ready-made and available. An individual process screen can be created using the configuration software. Using the extra-code recording function, important analog and digital process values can be saved so that they are tamper-proof, so that they can be graphically visualized, and so that they can be exported via interface or USB stick in a tamper-proof fashion to the PC.

The configuration software ensures that the process controller can be easily programmed, that math or logical coherences can be described, and that customer-specific linearizations can be created. In addition, tools for simulating external signals or control paths are included. These tools can also record for the duration of the startup.

A comprehensive alarm and limit-value concept as well as a flexible digital signal administration complete the "all-in-one" device.



Type 703571/...

Block diagram

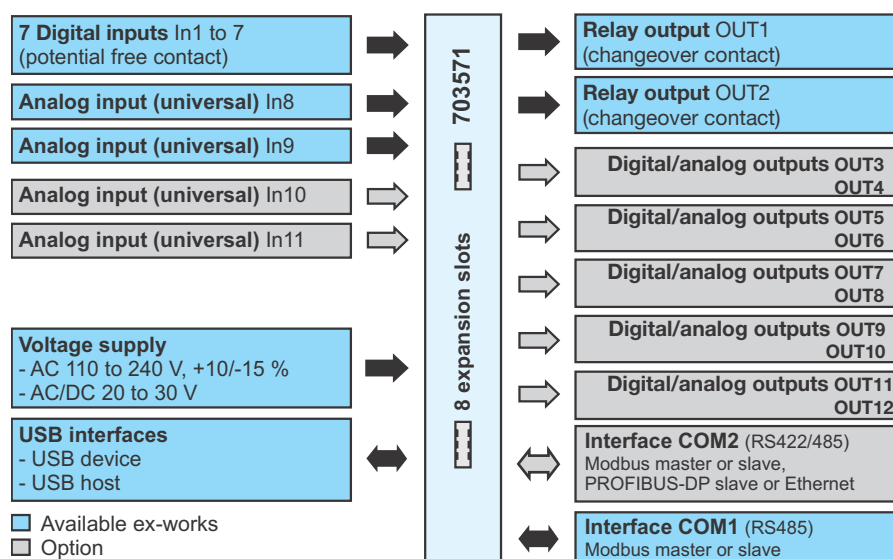

Special features

- Vibrant 3.5-inch color screen, with 320 × 240 pixels and 256 colors
- Easy-to-use program entry and program control
- Interfaces: USB host, USB device, Modbus (master/slave), PROFIBUS-DP, and Ethernet
- Integrated paperless recorder with tamper-proof data storage (extra code)
- Individual process-screen display with configurable edit boxes
- Math and logic functions
- Flexible through modular hardware
- Password-protected user administration
- Five-digit analog value display
- Individual operator level
- Control loop and output value monitoring
- Integrated timer and time switch Service and operating hours counter
- Web server for online visualization via a web browser
- Alarm transmission by email
- Protection type on the front IP66
- AMS2750/CQI-9 calibration certificate
- cUL, GL, DIN EN14597 approval applied for

Approvals/approval marks (see "Technical data")

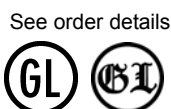



Description

Controller types

The controller can be configured as a two-state controller, three-state controller, modulating controller, continuous controller, or continuous controller with integrated position controller. The cycle time is 150 ms.

Parameter blocks

Four parameter blocks can be assigned to each controller. Each parameter block has 15 parameters. The controller structures P, I, PD, PI, and PID can be adjusted.

Self-optimization

Self-optimization also makes it possible for the controller to be matched to the control path by a user who is not a control technology expert. The way the control path reacts to changes in the actuating variable is evaluated in the process. Two different optimization processes are available. The oscillation method is preset as the standard method in the controller.

User level

Up to 25 parameters of any type from the configuration or parameter level can be included in this level. These parameters, for example, often need to be changed or made available to operating personnel (see "User administration").

User administration

Password-protected user administration guarantees safe process operation. This function allows the individual assignment of rights, enabling four users to access different levels and control commands.

Setpoint values

Up to four setpoint values can be entered for each controller channel. Toggling these setpoint values is controlled by two binary-coded digital signals. However, the setpoint values for both controllers can also be specified as an external setpoint specification via an additional analog input or an interface.

Program controller (extra code)

Ten programs with 50 sections can be programmed in the program controller. Each program can be assigned a program name and an icon.

Two setpoint values, section run times, operating contacts, tolerance bands, cycles, and parameter blocks can be assigned in each program section.

The tolerance band monitoring function monitors the actual value in an adjustable band around the setpoint value. The output signal of the tolerance band monitoring function can, for example, also be used to stop the program.

Ramp function

The ramp function allows a continuous change of the setpoint value to the ramp end value (setpoint specification) for each controller

channel. After power ON, the ramp starts at the current actual value. The slope of the ramp is determined via different gradients for a rising and falling ramp. The ramp starts at the time the setpoint value is changed or at the same time as a digital signal. The ramp function can be controlled by digital signals or via the functional level.

Limit value monitoring

There are 16 limit value monitorings each with 8 selectable alarm functions AF1 to AF8 available. The limit value can be fixed or be dependent on another value (setpoint value). Using additional parameters such as location and value of the switching differential, switch on/off delay, pulse function, type of acknowledgement and start-up alarm suppression extensive functions may be realized. Processes can be hindered through the start-up alarm suppression, for example the activation of the limit value monitoring during the start-up phase.

Math and logic function (extra code)

The math and logic module allows analog and/or digital signals to be operated. The following math formulas are available to the operators: +, -, *, /, SQRT(), MIN(), MAX(), SIN(), COS(), TAN(), **, EXP(), ABS(), INT(), FRC(), LOG(), LN(), humidity and floating average, as well as !, &, |, ^, and (and).

Difference, ratio, and humidity can also be configured on the device without extra code.

Analog inputs

The analog inputs (maximum of four) are universally configurable for RTD temperature probes, thermocouples, resistors (resistance transmitters, potentiometers), and standard signals (current, voltage). Linearizations for over 20 common measuring probes are saved. A measured value offset or a fine adjustment can be carried out to compensate for machine-specific deviations.

Due to the measuring circuit monitoring, out of range measurements (too high or too low), probe/cable break, and probe/cable short circuit are detected depending on the type of measuring probe. Due to the measuring circuit monitoring function, out of range (too high or too low), probe/cable break, and probe/cable short circuit are detected depending on the type of measuring probe so that the system is switched to a safe operating status (configurable) in the event of a fault.

Customer-specific linearization

A customer-specific linearization is additionally possible. Programming is carried out with the aid of the setup program, using a value table with 40 pairs of values or a fourth-order polynomial as a formula.

Analog outputs

Up to five analog outputs can be realized in the device. They can be used, for example, as controller outputs, setpoint value outputs, to

output results of the math formulas, or as actual value outputs. The signals are freely scalable.

Digital inputs

The signals of the seven standard digital inputs (potential-free contacts) can be used to initiate different internal functions, for example switching the parameter block, starting self-optimization, or acknowledging limit value monitoring.

Digital outputs

Up to 12 digital outputs can be realized in the device (see block diagram). They can be used as, for example, controller outputs, limit value monitoring signals, results of logic operations, or for programmer signals, etc.

External inputs

Eight external analog inputs and eight external digital inputs can each be read via an interface. The unit, range limits, and alarms can be adjusted for the external analog inputs.

Timers

Two timer functions are provided as standard. They can be used as relative timers or as weekly time switches (linked to the real-time clock).

Digital controller signals

There are eight digital control signals with different functions (OR operation, BCD operation, delay, inversion). The results are also available to control internal functions or they can be output to digital outputs.

Web server (online visualization)

This function is available with the insertion of the Ethernet interface on expansion slot COM2. All appearances in the device operating loop are automatically attainable without configuration.

Alarm transmission by email

An email alarm can be sent to up to three addresses simultaneously via a mail server.

Up to five alarm messages can be configured; the sending process is controlled by digital signals. There are five different alarm messages for this. These are linked to specific digital signals from the device.

JUMO GmbH & Co. KG

Hausadresse: Moritz-Juchheim-Straße 1, 36039 Fulda, Germany
Lieferadresse: Mackenrodtstraße 14, 36039 Fulda, Germany
Postadresse: 36035 Fulda, Germany

Telefon: +49 661 6003-727
Telefax: +49 661 6003-508
E-Mail: mail@jumo.net
Internet: www.jumo.net

**Recording function (extra code)**

Four analog channels and three digital channels can be recorded. They appear as line recorders with a time stamp. The recorder image is always present. It is only possible to use the "history" function and to extract the registry data via PCC, PCA by means of the extra code 213 recording function.

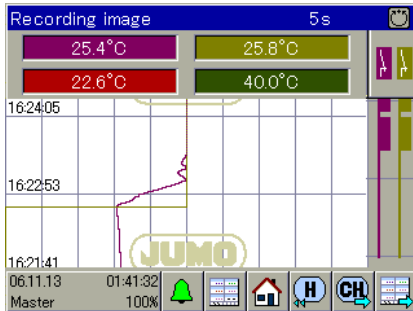
**Setup program**

The setup program makes the controller easy to configure and parameterize using a PC. Data sets can thus be created, edited, and transferred to the controller, and can be extracted from there. The data can be saved and printed. The setup program supports multiple national languages, including German, English, and French.

**External relay or logic modules
ER8 (accessories)**

By connecting two ER8 external logic modules, eight relay or digital outputs (12 V/20 mA) can be added to the device in each case. The control takes place via interface RS422/RS485. The setup program is essential for the configuration of the ER8 module that is mountable on the DIN-rail. Two ER8 modules can be connected.

Display and operating concept

The DICON touch is operated via a resistive touchscreen and also reacts to finger pressure. Commercially available pens with plastic tips can also be used.

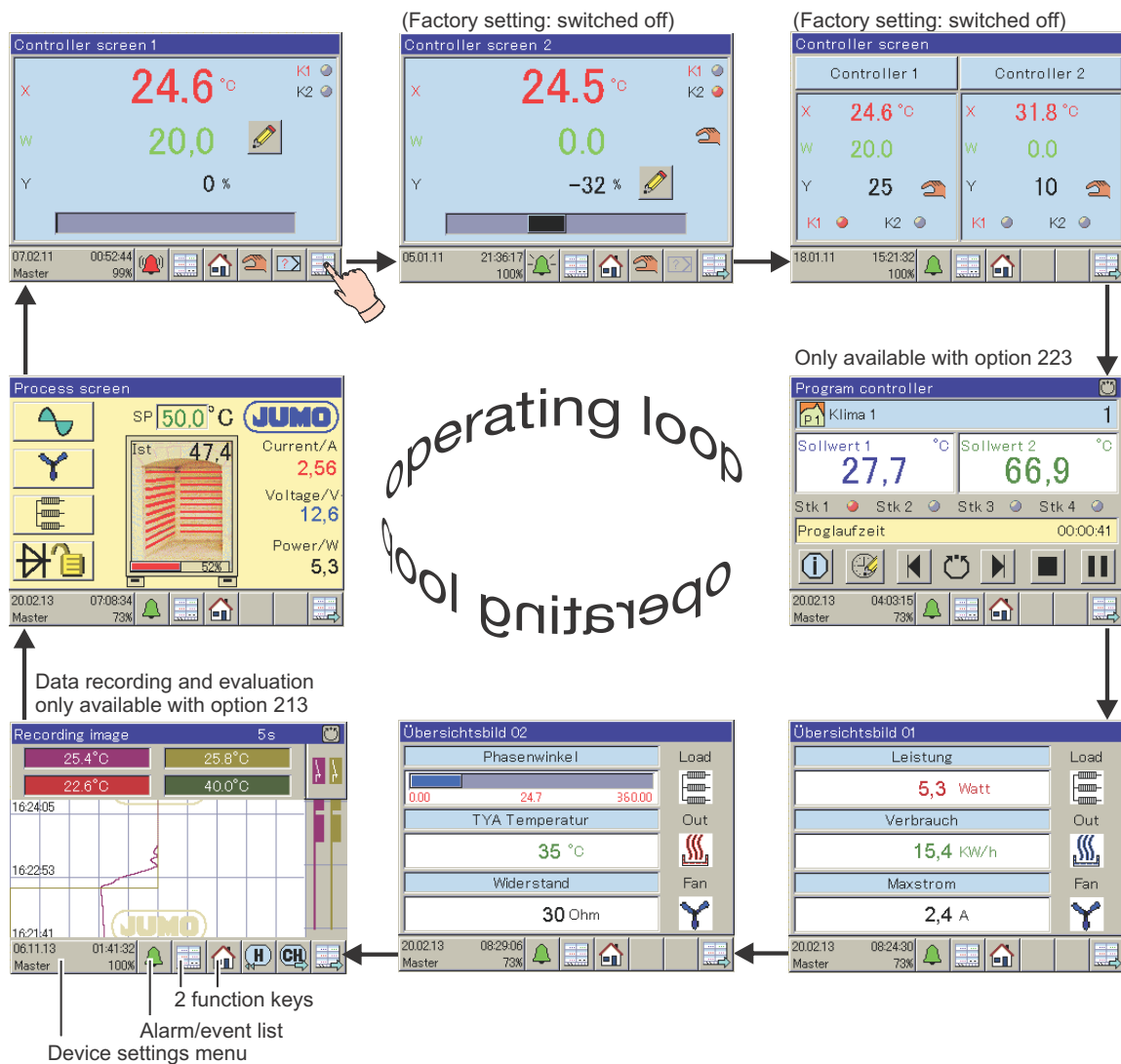
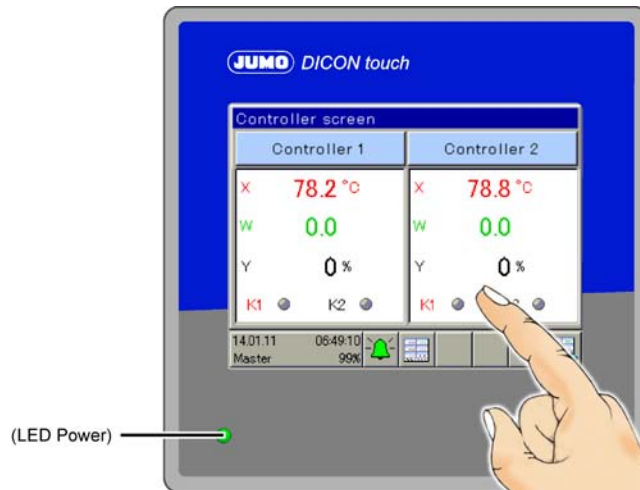



Controller parameters

The parameters and their meanings are listed in the table. Some parameters may be missing or meaningless for a particular type of controller. Three-state controllers have two controller structures that can be parameterized differently for "heating" and "cooling." Four parameter blocks can be managed for both of the controller channels.

Parameters	Value range	Default setting	Meaning
Proportional band Xp1	0 to 9999 digits	0 digits	Size of the proportional band The controller structure has no effect at 0! In the case of a continuous controller, Xp1 and Xp2 must be > 0.
Proportional band Xp2	0 to 9999 digits	0 digits	
Derivative time Tv1	0 to 9999 s	80 s	Influences the differential component of the controller output signal
Derivative time Tv2	0 to 9999 s	80 s	
Reset time Tn1	0 to 9999 s	350 s	Influences the integral component of the controller output signal
Reset time Tn2	0 to 9999 s	350 s	
Cycle time Cy1	0 to 999.9 s	20.0 s	When using a switched output, the cycle time should be chosen so that the energy supply to the process is as continuous as possible without overloading the switching elements.
Cycle time Cy2	0 to 999.9 s	20.0 s	
Contact spacing Xsh	0 to 999.9 digits	0.0 digits	Spacing between the two control contacts for three-state controllers, modulating controllers, and continuous controllers with integrated position controller
Switching differential Xd1	0 to 999.9 digits	1.0 digit	Hysteresis for switching controllers with proportional band = 0
Switching differential Xd2	0 to 999.9 digits	1.0 digit	
Actuator time TT	5 to 3000 s	60 s	Used run time range of the control valve for modulating controllers
Working point Y0	-100 to +100 %	0 %	The output level for P and PD controllers (if x = w then y = Y0)
Output level limits Y1	0 to 100 %	100 %	The maximum limit for the output level
Output value limits Y2	-100 to +100 %	-100 %	The minimum limit for the output level
Minimum relay ON time Tk1	0.000 to 60.00 s	0.000 s	Limits the frequency of switching for switched outputs
Minimum relay ON time Tk2	0.000 to 60.00 s	0.000 s	



Technical data

Analog inputs

General information

Standard number	Two universal analog inputs
Optional number	Two additional universal analog inputs via optional boards
A/D converter	Dynamic resolution up to 16-bit (for all input types)
Galvanic isolation	See chapter "Galvanic isolation"

Thermocouples

Description	Standard	Measuring range	Measuring accuracy ^a	Ambient temperature influence
Fe-CuNi "L"	DIN 43 710	-200 to +900 °C	≤ 0.25 %	≤ 100 ppm/K
Fe-CuNi "J"	DIN EN 60584	-200 to +1200 °C	≤ 0.25 %	≤ 100 ppm/K
Cu-CuNi "U"	DIN 43 710	-200 to +600 °C	≤ 0.25 %	≤ 100 ppm/K
Cu-CuNi "T"	DIN EN 60584	-200 to +400 °C	≤ 0.25 %	≤ 100 ppm/K
NiCr-Ni "K"	DIN EN 60584	-200 to +1372 °C	≤ 0.25 % ^b	≤ 100 ppm/K
NiCr-CuNi "E"	DIN EN 60584	-200 to +1000 °C	≤ 0.25 %	≤ 100 ppm/K
NiCrSi-NiSi "N"	DIN EN 60584	-100 to +1300 °C	≤ 0.25 %	≤ 100 ppm/K
Pt10Rh-Pt "S"	DIN EN 60584	-50 to 1768 °C	≤ 0.25 % ^c	≤ 100 ppm/K
Pt13Rh-Pt "R"	DIN EN 60584			
Pt30Rh-Pt6Rh "B"	DIN EN 60584	0 to 1820 °C	≤ 0.25 % ^d	≤ 100 ppm/K
Pt40Rh-Pt20Rh	ASTM E1751M-09	0 to 1888 °C	≤ 0.25 % ^e	≤ 100 ppm/K
Ir40Rh-Ir	ASTM E1751M-09	0 to 2110 °C	≤ 0.25 %	≤ 100 ppm/K
W5Re-W26Re "C"	ASTM E230M-11	0 to 2315 °C	≤ 0.25 %	≤ 100 ppm/K
W3Re-W25Re "D"	ASTM E1751M-09	0 to 2315 °C	≤ 0.25 %	≤ 100 ppm/K
Chromel®-CopeI®	GOST R 8.585-2001	-200 to +800 °C	≤ 0.25 %	≤ 100 ppm/K
Chromel®-Alumel® (like NiCr-Ni "K")	GOST R 8.585-2001	-200 to +1372 °C	≤ 0.25 %	≤ 100 ppm/K
Fe-CuNi "L"	GOST R 8.585-2001	-200 to +800 °C	≤ 0.25 %	≤ 100 ppm/K
Smallest measuring span		Type L, J, U, T, K, E, N, Chromel®-Alumel®: 100 K Type S, R, B, D, C, W3Re/W26Re, Chromel®-CopeI®: 500 K		
Measuring range start/end		Freely programmable within the limits in steps of 0.1 K		
Cold junction	GOST R	Pt100 internal, thermostat constant or external temperature probe		
Reference point accuracy (internal)		± 1 K		
Reference point temperature (external)		0 to +100 °C adjustable		
Sampling rate		Controller 1(2): 150 ms in total		
Input filter		Digital filter, 2nd order, filter constant can be set from 0 to 10.00 s		
Special features		Can also be programmed in °F		

^a The accuracy values refer to the maximum measuring range. Smaller measuring ranges lead to reduced linearization accuracy.

^b The accuracy values are first guaranteed from -150°.

^c The accuracy values are first guaranteed from 0 °C

^d The accuracy values are first guaranteed from 300 °C

^e The accuracy values are first guaranteed from 600 °C.



RTD temperature probe

Description	Standard	Measuring range	Measuring accuracy ^a	Ambient temperature influence
Pt50 Two-wire circuit Three-wire circuit	DIN EN 60751	-200 to +850 °C	≤ 0.05 %	≤ 50 ppm/K
Cu50 Two-wire circuit Three-wire circuit	IEC 60 317	-50 to +200 °C	≤ 0.15 %	≤ 50 ppm/K
Pt100 Two-wire circuit Three-wire circuit	DIN EN 60751	-200 to +850 °C	≤ 0.05 %	≤ 50 ppm/K
Pt500 Two-wire circuit Three-wire circuit	DIN EN 60751	-200 to +850 °C	≤ 0.1 %	≤ 50 ppm/K
Pt1000 Two-wire circuit Three-wire circuit	DIN EN 60751	-200 to +850 °C	≤ 0.1 %	≤ 50 ppm/K
Ni100 Two-wire circuit Three-wire circuit	DIN 43760	-60 to +250 °C	≤ 0.15 %	≤ 50 ppm/K
Ni1000 Two-wire circuit Three-wire circuit	DIN 43760	-60 to +250 °C	≤ 0.1 %	≤ 50 ppm/K
KTY11-6 Two-wire circuit		-50 to +150 °C	≤ 1 %	≤ 50 ppm/K
Pt50 Two-wire circuit Three-wire circuit	GOST 6651-99	-200 to +850 °C	≤ 0.05 %	≤ 50 ppm/K
Pt100 Two-wire circuit Three-wire circuit	GOST 6651-94	-200 to +850 °C	≤ 0.05 %	≤ 50 ppm/K
Cu50 Two-wire circuit Three-wire circuit	GOST 6651-94	-50 to +200 °C	≤ 0.15 %	≤ 50 ppm/K
Cu100 Two-wire circuit Three-wire circuit	GOST 6651-94	-50 to +200 °C	≤ 0.15 %	≤ 50 ppm/K
Smallest measuring span		15 K		
Measuring current		Pt100 approx. 250 µA, Pt1000 approx. 100 µA		
Sensor lead resistance		Max. 10 Ω per cable for two-wire and three-wire circuits		
Lead compensation		Not required for a three-wire circuit. For a two-wire circuit, the lead compensation can be compensated for in the software by correcting the process value.		
Measuring range start/end		Freely programmable within the limits in steps of 0.1 K		
Sampling rate		Controller 1(2): 150 ms in total		
Input filter		Digital filter, 2nd order; filter time constant can be set from 0 to 100 s		
Special features		Can also be programmed in °F		

^a The accuracy values refer to the maximum measuring range. Smaller measuring ranges lead to reduced linearization accuracy.



Standard signals

Description	Measuring range	Measuring accuracy ^a	Ambient temperature influence
Freely scalable voltage Input resistance R _E > 500 kΩ Input resistance R _E > 100 kΩ	DC 0(2) to 10 V DC 0 to 1 V 0 to 100 mV	≤ 0.1 %	≤ 100 ppm/K
Smallest measuring span	5 mV		
Measuring range start/end	Freely programmable within the limits in steps of 0.01 mV		
Current (voltage drop ≤ 2 V), freely scalable	DC 0(4) to 20 mA	≤ 0.1 %	≤ 100 ppm/K
Smallest measuring span	0.5 mA		
Measuring range start/end	Freely programmable within the limits in steps of 0.01 mA		
Limits in accordance with NAMUR recommendation NE 43 in case of deviation above/below measured range		Signal type 2 to 10 V	Signal type 4 to 20 mA
Measurement information M		1.9 to 10.25 V	3.8 to 20.5 mA
Failure information A for deviation below measured value/short-circuit ("NAMUR Low")		≤ 1.8 V	≤ 3.6 mA
Failure information A for deviation above measured value/probe break ("NAMUR High")		≥ 10.5 V	≥ 21 mA
Sampling rate	Controller 1(2): 150 ms in total		
Input filter	Digital filter, 2nd order; filter constant can be set from 0 to 10.0 s		
Galvanic isolation	See Chapter "Electrical data", page 10 and Chapter "Galvanic isolation", page 12		
Resistance transmitter	Min. 100 Ω, max. 10 kΩ	≤ 0.5 % ^b	≤ 100 ppm/K
Connection type	Resistance transmitter: three-wire circuit		
Smallest measuring span	60 Ω		
Sensor lead resistance	Max. 10 Ω per cable for two-wire and three-wire circuits		
Resistance values	Freely programmable within the limits in steps of 0.1 Ω		
Sampling rate	Controller 1(2): 150 ms in total		
Input filter	Digital filter, 2nd order, filter constant can be set from 0 to 10.00 s		

^a The accuracy values refer to the maximum measuring range. Smaller measuring ranges lead to reduced linearization accuracy.

^b The accuracy values refer to the maximum measuring range (initial resistance R_a + loop resistance R_S + end resistance R_e).

Measuring circuit monitoring

In the event of a malfunction, the outputs move to a defined (configurable) status.

Measuring probe	Out of range	Probe/cable short circuit	Probe/cable break
Thermocouple	is detected	is not detected	is detected
RTD temperature probe	is detected	is detected	is detected
Voltage 2 to 10 V 0 to 10 V 0 to 1 V	is detected is detected is detected	is detected is not detected is not detected	is detected is not detected is not detected
Current 4 to 20 mA 0 to 20 mA	is detected is detected	is detected is not detected	is detected is not detected
Resistance transmitter	is not detected	is not detected	is detected

Digital inputs

Standard number	7
Control	Potential-free contact



Analog outputs

Per optional board (OUT3, 5, 7, 9 and OUT11 are possible)

1 analog output (configurable) A/D converter 12 bit resolution Voltage DC 0(2) to 10 V Current DC 0(4) to 20 mA	Load resistance R_{load}	Accuracy	Ambient temperature influence
	$\geq 500 \Omega$	$\pm 0.25 \%$	$\pm 100 \text{ ppm/K}$
	$\leq 500 \Omega$	$\pm 0.25 \%$	$\pm 100 \text{ ppm/K}$

Digital outputs

Standard

Two relay outputs (changeover contact) Switching capacity Contact life	Max. 3 A at AC 250 V, resistive load 150,000 operations at nominal load
--	--

Per optional board

One relay output (changeover contact) Switching capacity Contact life	Max. 3 A at AC 250 V, resistive load 150,000 operations at nominal load
Two relay outputs (N/O contact) ^a Switching capacity Contact life	Max. 3 A at AC 250 V, resistive load 150,000 operations at nominal load
One solid state relay, two solid state relay for motor actuators Switching capacity Protection circuitry	1 A at AC 230 V, resistive load Varistor
One logic output (voltage supply for transmitter)	DC 0/22 V, max. 30 mA (short-circuit proof)
Two logic outputs	DC 0/12 V max. 20 mA (short-circuit proof, not galvanically isolated)
Two PhotoMOS [®] relays ^b	DC 50 V, max. 200 mA, (galvanically isolated from each other, not short-circuit proof) AC 35 V, max. 200 mA, (galvanically isolated from each other, not short-circuit proof)

^a Combining a mains voltage circuit with a protective low-voltage circuit on the "dual normally open contact" option is not admissible.

^b PhotoMOS is a registered trademark of Panasonic Corporation.

Controllers

Controller types	Inverse/direct two-state controller, three-state controller, three-state modulating controller, inverse/direct continuous controller, continuous controller with integrated position controller
Controller structures	P, PD, PI, PID
Sampling rate	150 ms
Parameter blocks	Four parameter blocks per controller

Screen

Resolution, size	320 × 240 pixels, 3.5 "
Type, number of colors	TFT color screen, 256 colors
Brightness setting	Adjustable on the device
Device operation	Via resistive touchscreen
Screensaver	Via waiting period or control signal
Display operating life	50 000 h



Electrical data

Voltage supply Connection Voltage	At the back via screw terminals AC/DC 20 ... 30 V, 48 to 63 Hz or AC 110 to 240 V +10/-15 %, 48 to 63 Hz	
Power consumption	At voltage supply 230 V: max. 38.1 VA/11.5 W At voltage supply 24 V: max. 21.9 VA/11.5 W	
Inputs and outputs Connection Conductor cross section	At the back via screw terminals Max. 2.5 mm ² , wire or strand with end sleeve	
Electrical safety	According to DIN EN 61010-1 Overvoltage category III, pollution degree 2	
Electromagnetic compatibility Interference emission Interference immunity	According to DIN EN 61326-1 Class A - For industrial applications only Industrial requirements	
Memory data recorder	Memory cycle	Recording interval
When recording:	1 s	approx. 44 days
4 analog signals	5 s	approx. 220 days
3 digital signals	10 s	approx. 441 days
	60 s	approx. 2646 days (7 years, 91 days)

Environmental influences

Ambient/storage temperature range	-5 to +55 °C/-30 to +70 °C
Resistance to climatic conditions	Humidity 3K3 (DIN EN 60721-3-3) with extended temperature range, rel. humidity ≤ 95 % mid-year without condensation

Case

Case type	Plastic front frame with metal case barrel
Front frame dimensions	96 mm × 96 mm
Panel cut-out	92 ^{+0.8} mm × 92 ^{+0.8} mm according to DIN IEC 61554
Close mounting	Spacing between the panel cut-outs, min. 35 mm horizontally and min. 80 mm vertically
Panel thickness	Max. 5 mm
Depth behind panel	Max. 130 mm
Mounting	Four mounting brackets
Operating position (including the viewing angle of the TFT color screen)	Any Horizontal ±65°, vertical +40 to -65°
Protection type	Front IP66, rear IP20, according to DIN EN 60529
Weight (fully fitted)	approx. 1000 g

Approvals/approval marks

Approval mark	Testing agency	Certificate/certification number	Inspection basis	Valid for
GL - hardware GL - software	Germanischer Lloyd	11 172-14 HH	Environmental Category C EMC 1	Besides the marked modules for expansion slots, see order details
c UL us	Underwriters Laboratories	Approval submitted	UL 61010-1	All modules
GOST		Approval submitted		All modules

Connection elements

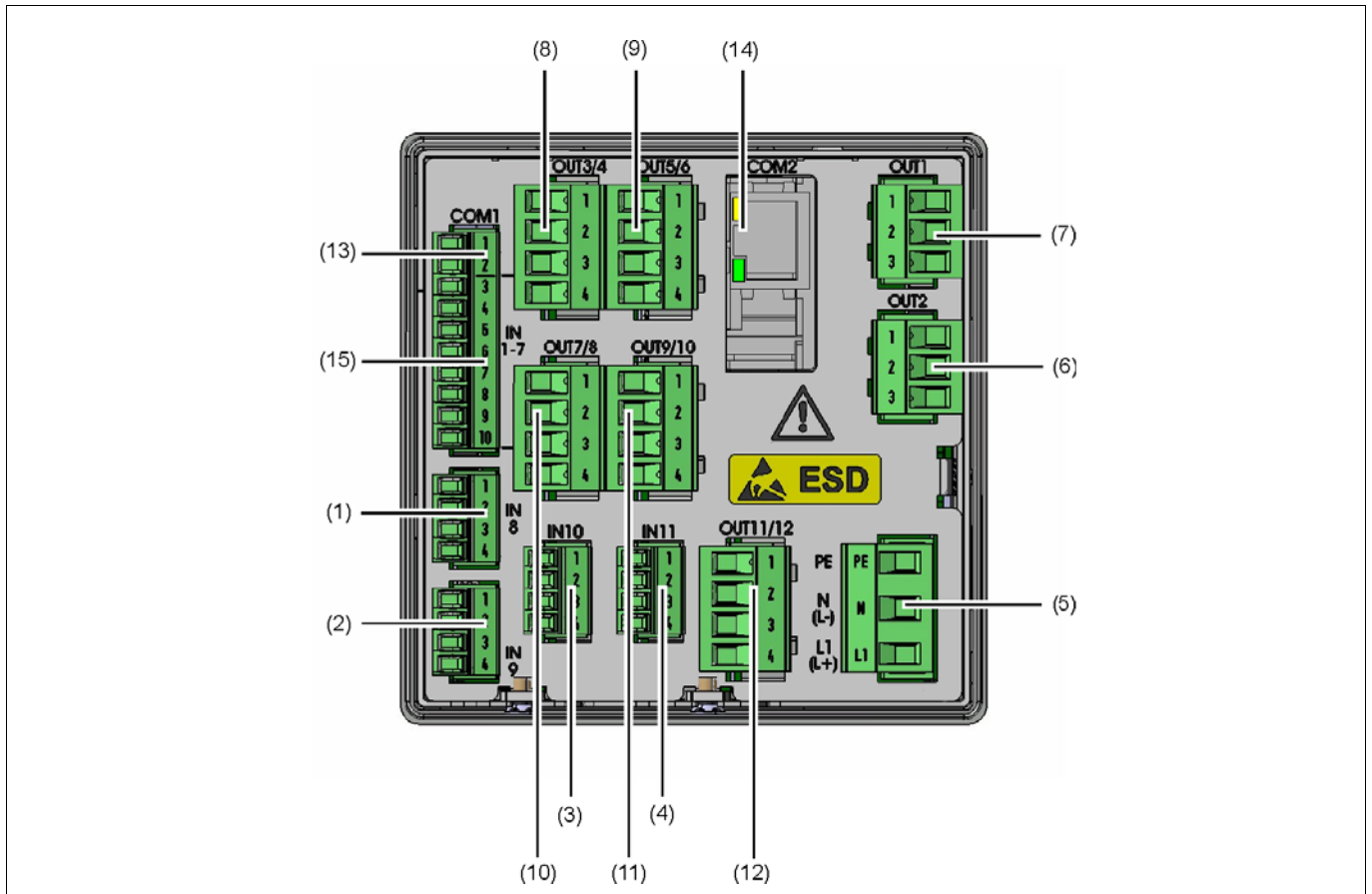

- | | |
|--|--|
| (1) Analog input IN8 | (2) Analog input IN9 |
| (3) Expansion slot for analog input IN10 | (4) Expansion slot for analog input IN11 |
| (5) Voltage supply
AC 240 V +10/-15 %, 48 to 63 Hz, max. 38.1 VA
AC/DC 20 to 30 V, 48 to 63 Hz,
max. 21.9 VA / 11.5 W | (6) Relay output OUT2 |
| (7) Relay output OUT1 | (8) Expansion slot for outputs OUT3/4 |
| (9) Expansion slot for outputs OUT5/6 | (10) Expansion slot for outputs OUT7/8 |
| (11) Expansion slot for outputs OUT9/10 | (12) Expansion slot for outputs OUT11/12 |
| (13) COM1 interface RS485 | (14) Expansion slot for COM2 interface |
| (15) Digital inputs IN1 to 7 | |



Galvanic isolation

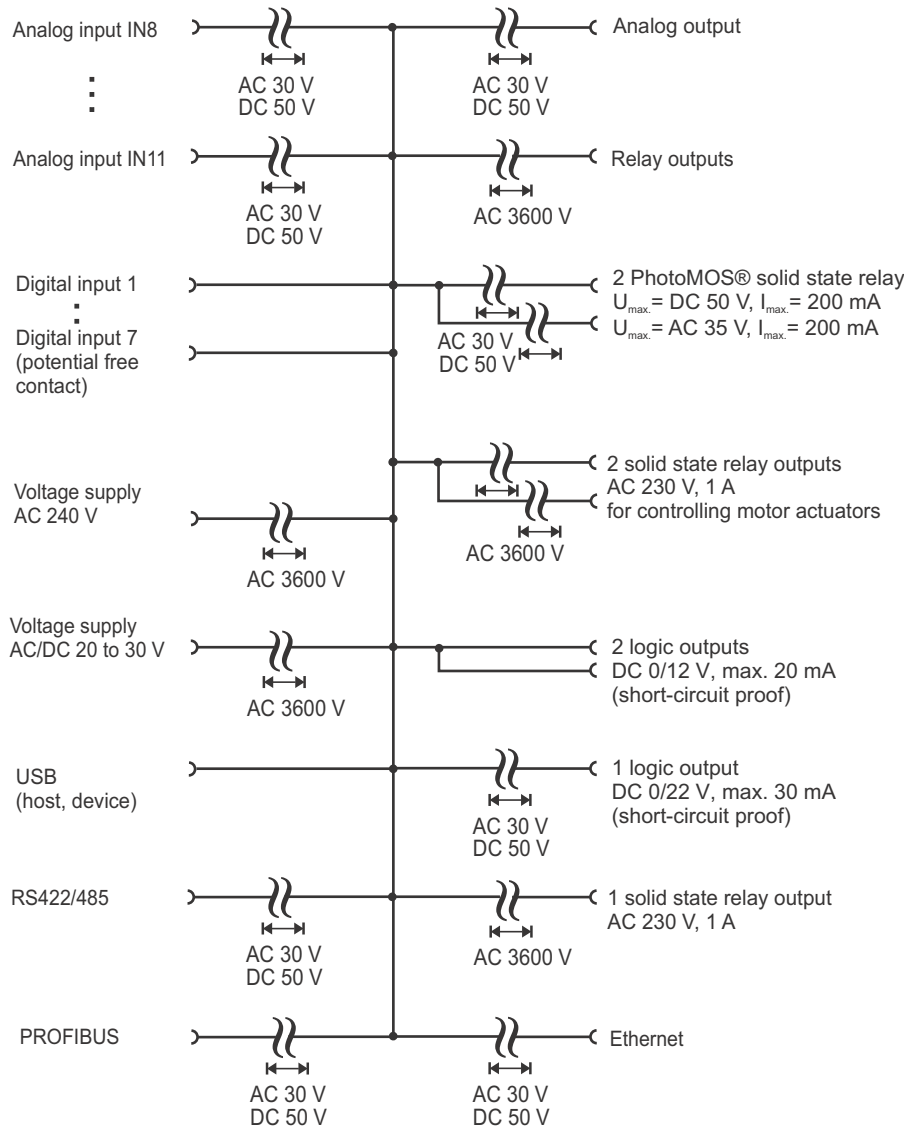

Connection diagram

The connection diagram included in the data sheet provides initial information about the connection options. Only use the installation instructions or the operating manual for the electrical connection. The know-how and the correct technical implementation of the safety warnings/instructions contained in these documents are the prerequisite for the installation, electrical connection, and initial start as well as for the safety during operation.

Analog inputs

Input IN8, IN9 as standard

Two analog inputs can be added to input (IN10), (IN11) optional boards

Connection	(Connection element) Input	Symbol and terminal designation
Thermocouple	(1) IN8 (2) IN9 (3) IN10 (4) IN11	
RTD temperature probe Two-wire circuit		
RTD temperature probe Three-wire circuit		
Voltage DC 0(2) to 10 V		
Voltage DC 0 to 1 V		
Voltage DC 0 to 100 mV		
Current DC 0(4) to 20 mA		
Resistance transmitter A = Start E = End S = Slider		

Analog outputs

One analog output can be added to output OUT 3/4 to 11/12 using optional boards

Connection	(Connection element) Input	Symbol and terminal designation
One analog output DC 0/2 to 10 V or DC 0/4 to 20 mA (configurable)	(8) OUT3/4 (9) OUT5/6 (10) OUT7/8 (11) OUT9/10 (12) OUT11/12	

Digital inputs

Input IN1 to 7 as standard (cannot be extended)

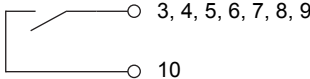
Connection	(Connection element) Input	Symbol and terminal designation
Digital input, potential-free contact as standard	(15) IN1 to 7	

Digital outputs

OUT1 and OUT2 as standard

The controller is fitted with two relay outputs (changeover contacts) as standard.

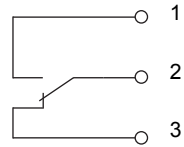
Connection	(Connection element) Output	Symbol and terminal designation
Relay output (changeover contact)	(6) OUT2 (7) OUT1	

Outputs OUT 3/4 to 11/12 are expandable using the following optional boards

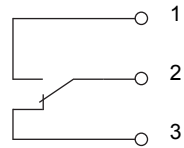
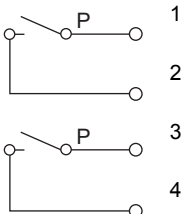
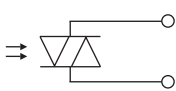
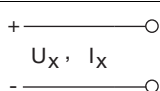
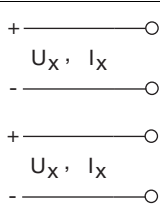
Connection	(Connection element) Output	Symbol and terminal designation
One relay output (changeover contact)	(8) OUT3/4 (9) OUT5/6 (10) OUT7/8 (11) OUT9/10 (12) OUT11/12	
Two relay outputs (N/O contact) ^a		
One solid state relay AC 230 V, 1 A		
One logic output DC 0/22 V, max. 30 mA (short-circuit proof)		
Two logic outputs DC 0/12 V max. 20 mA (short-circuit proof, not galvanically isolated from each other)		

Connection	(Connection element) Output	Symbol and terminal designation
Two PhotoMOS® relays ^b max. DC 50 V, 200 mA max. AC 35 V, 200 mA (galvanically isolated)		
Two solid state relays AC 230 V, 1 A (for controlling the left and right-hand motor actuators, galvanically isolated)		

^a Combining a mains voltage circuit with a protective low-voltage circuit on the "dual normally open contact" option is not admissible.

^b PhotoMOS is a registered trademark of Panasonic Corporation.



Voltage supply (according to nameplate)

AC 230V (DC 24V)



Connection	(Connection element)	Symbol and terminal designation
Protection conductor	PE	
Neutral conductor	N (L-)	N
Line conductor	L1(L+)	L1

Interfaces

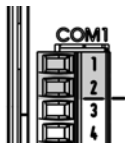
USB device, USB host and COM1 interfaces as standard

Connection	(Connection element)	Symbol and terminal designation				
USB device interface	(21)					
USB host	(20)					
COM1 serial interface RS485 (galvanically isolated)	(13)	 <table style="display: inline-table; vertical-align: top; margin-left: 10px;"> <tr> <td>1 TxD+/RxD+</td> <td>Transmission/received data +</td> </tr> <tr> <td>2 TxD-/RxD-</td> <td>Transmission/received data -</td> </tr> </table>	1 TxD+/RxD+	Transmission/received data +	2 TxD-/RxD-	Transmission/received data -
1 TxD+/RxD+	Transmission/received data +					
2 TxD-/RxD-	Transmission/received data -					

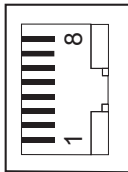
COM2 interface can be expanded using optional boards

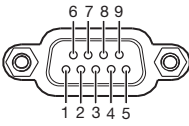
Connection	(Connection element)	Symbol and terminal designation								
Ethernet	(14)	 <table style="display: inline-table; vertical-align: top; margin-left: 10px;"> <tr> <td>1 TX+</td> <td>Transmission data +</td> </tr> <tr> <td>2 TX-</td> <td>Transmission data -</td> </tr> <tr> <td>3 RX+</td> <td>Received data +</td> </tr> <tr> <td>6 RX-</td> <td>Received data -</td> </tr> </table>	1 TX+	Transmission data +	2 TX-	Transmission data -	3 RX+	Received data +	6 RX-	Received data -
1 TX+	Transmission data +									
2 TX-	Transmission data -									
3 RX+	Received data +									
6 RX-	Received data -									
Serial interface RS422 (galvanically isolated)		 <table style="display: inline-table; vertical-align: top; margin-left: 10px;"> <tr> <td>1 RxD+</td> <td>Received data +</td> </tr> <tr> <td>2 RxD-</td> <td>Received data -</td> </tr> <tr> <td>3 TxD+</td> <td>Transmission data +</td> </tr> <tr> <td>4 TxD-</td> <td>Transmission data -</td> </tr> </table>	1 RxD+	Received data +	2 RxD-	Received data -	3 TxD+	Transmission data +	4 TxD-	Transmission data -
1 RxD+	Received data +									
2 RxD-	Received data -									
3 TxD+	Transmission data +									
4 TxD-	Transmission data -									
Serial interface RS485 (galvanically isolated)		 <table style="display: inline-table; vertical-align: top; margin-left: 10px;"> <tr> <td>3 TxD+/RxD+</td> <td>Transmission/received data +</td> </tr> <tr> <td>4 TxD-/RxD-</td> <td>Transmission/received data -</td> </tr> </table>	3 TxD+/RxD+	Transmission/received data +	4 TxD-/RxD-	Transmission/received data -				
3 TxD+/RxD+	Transmission/received data +									
4 TxD-/RxD-	Transmission/received data -									
PROFIBUS-DP		 <table style="display: inline-table; vertical-align: top; margin-left: 10px;"> <tr> <td>3 RxD/TxD-P (B)</td> <td>Transmission/received data +</td> </tr> <tr> <td>5 DGND</td> <td>Ground</td> </tr> <tr> <td>6 VP (+5 V)</td> <td>Voltage supply</td> </tr> <tr> <td>8 RxD/TxD-N (A)</td> <td>Transmission/received data -</td> </tr> </table>	3 RxD/TxD-P (B)	Transmission/received data +	5 DGND	Ground	6 VP (+5 V)	Voltage supply	8 RxD/TxD-N (A)	Transmission/received data -
3 RxD/TxD-P (B)	Transmission/received data +									
5 DGND	Ground									
6 VP (+5 V)	Voltage supply									
8 RxD/TxD-N (A)	Transmission/received data -									

Dimensions

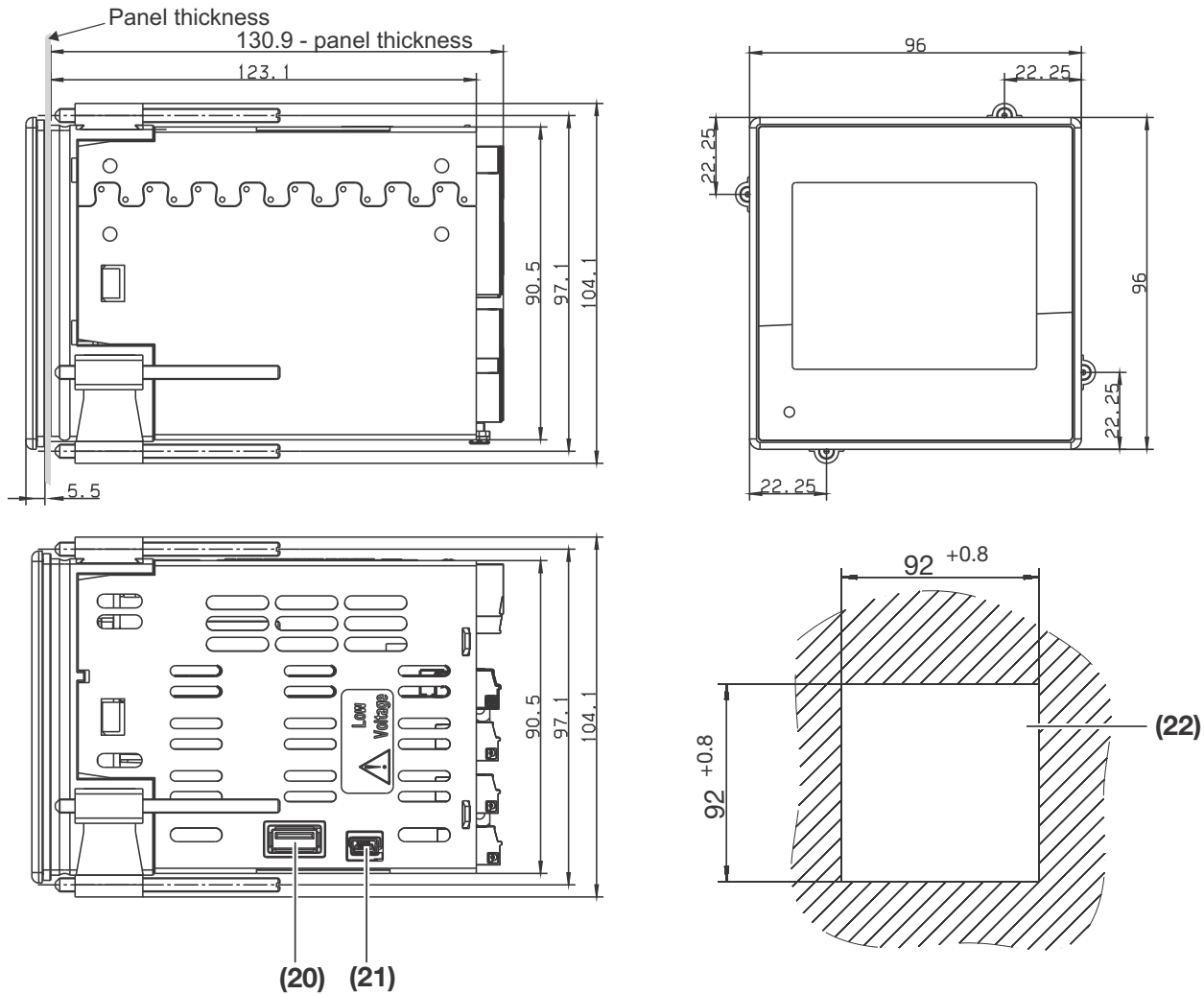

- (20) USB host interface
- (22) Panel cut-out

- (21) USB device interface for setup

Scope of delivery

- 1 controller in the ordered version
- 1 Operating Manual B 703571.0
- 1 panel seal 4 retaining elements for panel installation



Order details

(1) Basic type	
703571	JUMO DICON touch - two-channel process and program controller with RS485 interface
(2) Version	
8	Standard with default settings
9	Customer-specific configuration (specifications in plain text)
(3) National language of display texts	
01	German
02	English
03	French
(4) Input IN10	
00	Not used
10	Analog input (universal)
(5) Input IN11	
00	Not used
10	Analog input (universal)
(6) Outputs OUT3/4	
00	None
11	One relay (changeover contact)
12	Two relays (N/O contact)
13	One solid-state relay 230 V, 1 A
14	One logic output DC 0/22 V max. 30 mA ^a
15	Two logic outputs 0/12 V, 20 mA
16	One analog output
17	Two PhotoMOS® relays ^b
20	Two solid state relays 230 V, 1 A for motor actuator (double slot: OUT3/4 and OUT7/8) ^a
(7) Outputs OUT5/6	
00	None
11	One relay (changeover contact)
12	Two relays (N/O contact)
13	One solid-state relay 230 V, 1 A
14	One logic output 0/22 V, max. 30 mA ^a
15	Two logic outputs 0/12 V, 20 mA
16	One analog output
17	Two PhotoMOS® relays
20	Two solid state relays 230 V, 1 A for motor actuator (double slot: OUT5/6 and OUT9/10) ^a
(8) Outputs OUT7/8 (only available for assignment with module 20 on OUT3/4)	
00	None
11	One relay (changeover contact)
12	Two relays (N/O contact)
13	One solid-state relay 230 V, 1 A
14	One logic output 0/22 V, max. 30 mA ^a
15	Two logic outputs 0/12 V, 20 mA
16	One analog output
17	Two PhotoMOS® relays
(9) Outputs OUT9/10 (only available for assignment with module 20 on OUT5/6)	
00	None
11	One relay (changeover contact)
12	Two relays (N/O contact)
13	One solid-state relay 230 V, 1 A
14	One logic output 0/22 V, max. 30 mA ^a

JUMO GmbH & Co. KG

Hausadresse: Moritz-Juchheim-Straße 1, 36039 Fulda, Germany
 Lieferadresse: Mackenrodtstraße 14, 36039 Fulda, Germany
 Postadresse: 36035 Fulda, Germany

Telefon: +49 661 6003-727
 Telefax: +49 661 6003-508
 E-Mail: mail@jumo.net
 Internet: www.jumo.net



15	Two logic outputs 0/12 V, 20 mA
16	One analog output
17	Two PhotoMOS® relays
(10) Outputs OUT11/12	
00	None
11	One relay (changeover contact)
12	Two relays (N/O contact)
13	One solid-state relay 230 V, 1 A
14	One logic output 0/22 V, max. 30 mA ^a
15	Two logic outputs 0/12 V, 20 mA
16	One analog output
17	Two PhotoMOS® relays
(11) Voltage supply	
23	AC 110 to 240 V +10/-15 %, 48 to 63 Hz
25	AC/DC 20 to 30 V, 48 to 63 Hz ^a
(12) COM2 interface	
00	Not used
08	Ethernet
54	RS422/485 Modbus RTU
64	PROFIBUS-DP ^a
(13) DIN-tested	
000	Without approval
056	With DIN approval
(14) GL-tested	
000	Without approval
062	With GL approval
(15) Extra code	
000	Without extra code
213	Recording function
214	Math and logic module
223	Program controller
879	AMS2750/CQI-9 ^c

^a GL approval still not available



^b PhotoMOS is a registered trademark of Panasonic Corporation

^c For the calibration certificate the channels to be checked are to be defined with the thermocouple type and the desired measuring points.

Order code (1) / (2) - (3) - (4) (5) - (6) (7) (8) (9) (10) - (11) - (12) / (13) , (14) , (15)
 [] / [] - [] - [] [] - [] [] [] [] [] - [] - [] / [] , [] , [] , ...^a
Order example 703571 / X - X - X X - X X X X X X - X - X / X , X , X

^a List extra codes in sequence, separated by commas.

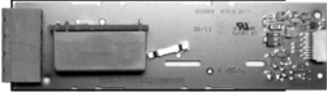
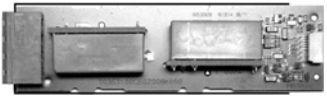
Accessories

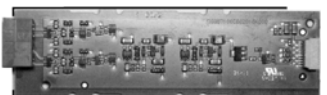
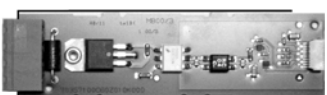
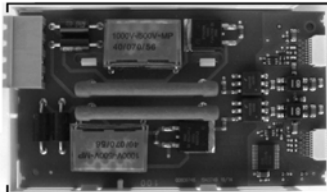
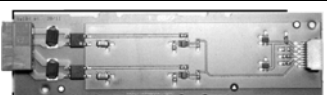
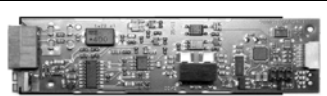
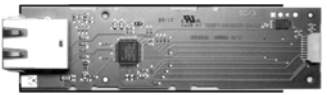
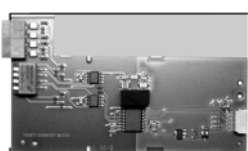
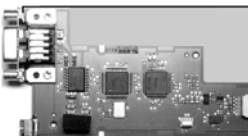
Item		Parts no.
Modules for expansion slots:		
One analog input (universal)		00581159
One relay output (changeover contact)		00581160
Two relay outputs (N/O contact)		00581162
One logic output DC 0/22 V, max. 30 mA		00581165
Two logic outputs DC 0/12 V max. 20 mA		00581168
One solid state relay AC 230 V, 1 A		00581164
Two solid state relays AC 230 V, 1 A for motor actuator		00621574
Two PhotoMOS® relays ^a DC 50 V, max. 200 mA, AC 35 V, max. 200 mA		00581171
One analog output (universal)		00581169
Ethernet interface		00581174
Serial interface RS422/RS485		00581172
PROFIBUS-DP interface		00581173

^a PhotoMOS is a registered trademark of Panasonic Corporation

JUMO GmbH & Co. KG

Hausadresse: Moritz-Juchheim-Straße 1, 36039 Fulda, Germany
Lieferadresse: Mackenrodtstraße 14, 36039 Fulda, Germany
Postadresse: 36035 Fulda, Germany

Telefon: +49 661 6003-727

Telefax: +49 661 6003-508

E-Mail: mail@jumo.net

Internet: www.jumo.net



General accessories

Article	Part no.
Program editor/startup	00607139
Setup/program editor	00606496
PCA3000/PCC JUMO software package 709701/709702	00431884
USB cable A-connector mini B-connector 3 m	00506252