

METRISO INTRO, BASE, TECH

Insulation, Low Resistance and Voltage Measurement Instrument

3-349-812-03
3/12.15



Features Overview of Both Instrument Variants

METRISO	INTRO	BASE	TECH
Article number	M550N	M5500	M550P
Measurements			
R _{INS} U = 1000 V	✓	—	✓
R _{INS} U = 250, 500 V	✓	✓	✓
R _{INS} U = 50, 100 V	—	✓	✓
R 10 Ω ... 10 kΩ	—	✓	✓
R _{LO} 0.17 Ω ... 10 Ω	✓	✓	✓
U 0 ... 1000 V	✓	—	✓
U 0 ... 500 V	✓	✓	✓
Display Functions			
Backlit display	✓	✓	✓
Limit value LED (green/red) for: Additional acoustic signal, limit value per VDE 0100	R _{INS} R _{LO}	R _{INS} R _{LO}	R _{INS} R _{LO}
LED for dangerous contact voltage (when switched off)	—	✓	✓
LCD symbol for external voltage	✓	✓	✓
Battery level display	✓	✓	✓
Special Functions			
Discharge capacitive devices under test	✓	✓	✓
Safety shutdown (UBatt < 8 V)	✓	✓	✓
Features			
CAT II 1000 V / CAT III 600 V / CAT IV 300 V	✓	—	✓
Measuring category CAT III 600 V / CAT IV 300 V	✓	✓	✓
10 MΩ test resistor	—	✓	✓
DAkKS calibration certificate	—	✓	✓

Scope of delivery:

- 1 Insulation and resistance measuring instrument
- 1 DAkKS calibration certificate (not METRISO INTRO)
- 1 Set batteries (8 ea. in battery holder) (not METRISO INTRO)
- 1 Carrying strap
- 1 Alligator clip (not METRISO INTRO)
- 1 KS17-4 cable set
- 1 Condensed operating instructions
- 1 Supplement Safety Information
- 1 Detailed operating instructions for download from our website at www.gossenmetrawatt.com

Battery Compartment Lid and Location of the Fuses (housing bottom)

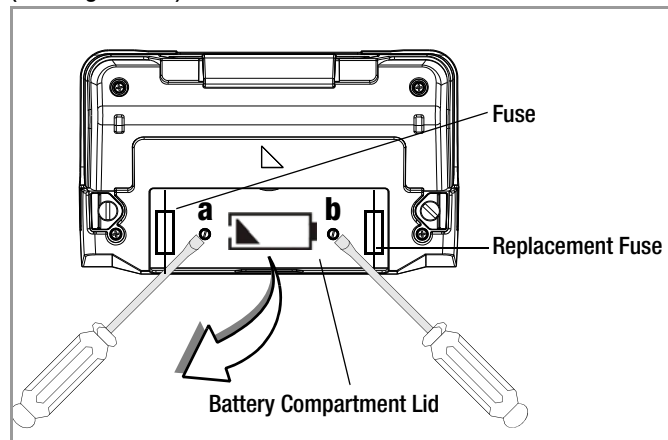

Inserting the Battery Holder (side view)

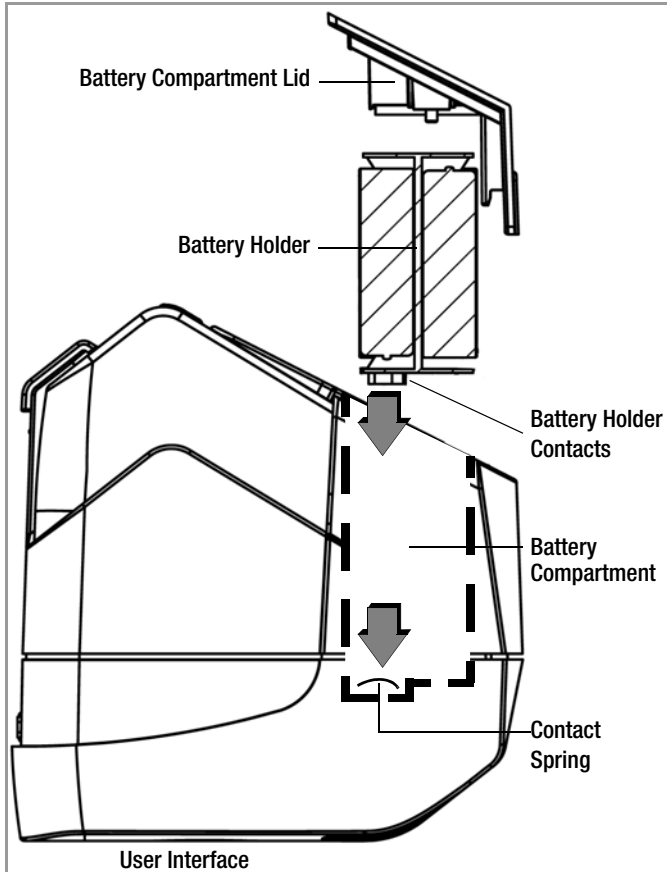

Connections (housing top)

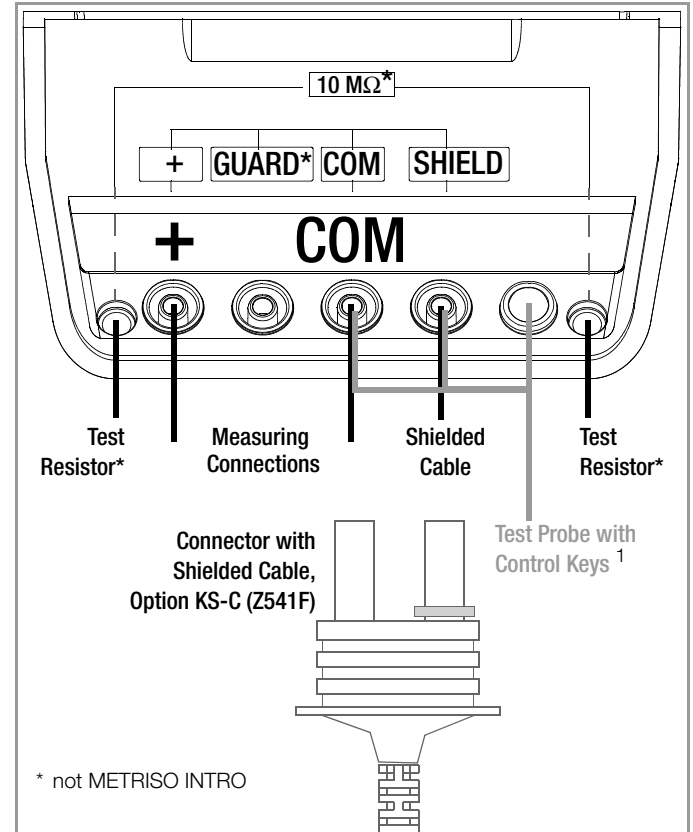

* not METRISO INTRO

¹ Z550A accessory as option: Test probe with a key for triggering measurement, and an additional key for illuminating the measuring point, including shielded plug-in connector cable



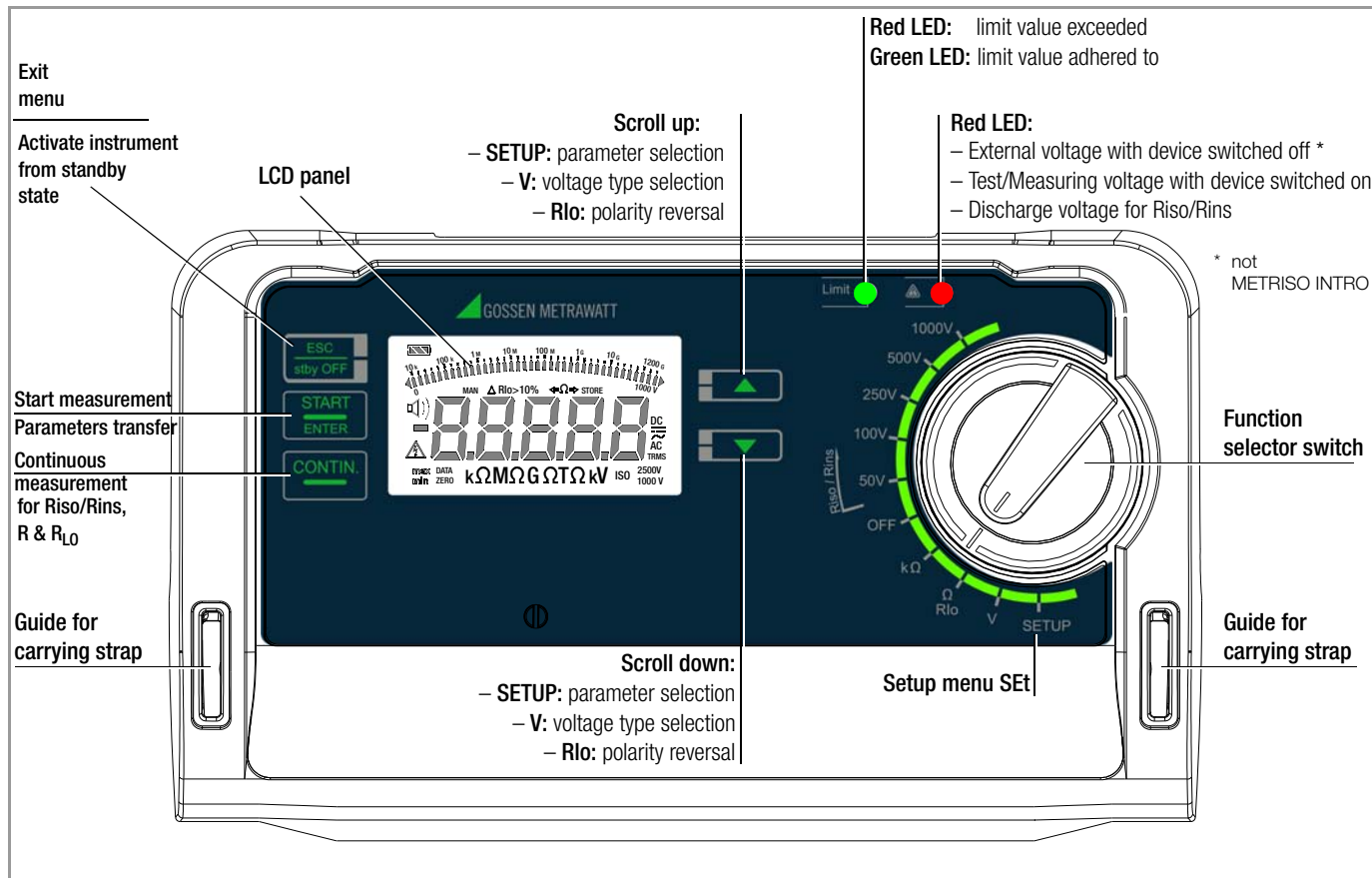

User Interface (Example METRISO TECH)

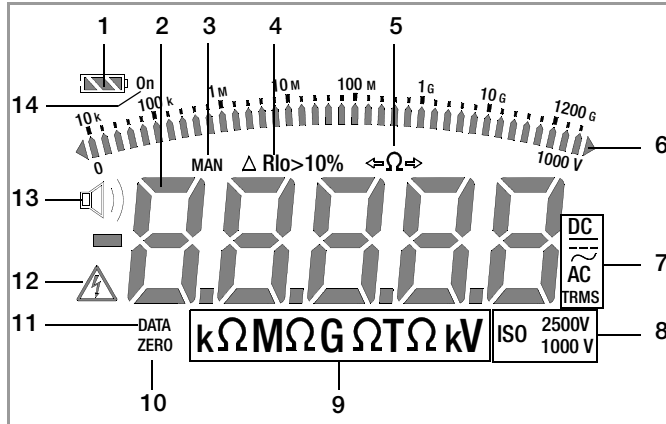



Digital Display Symbols



Battery level indicator

-  Battery full
-  Battery OK
-  Battery weak
-  Battery (almost) dead, $U < 8.5 \text{ V}$

- 1  Battery level indicator
- 2 Digital display with decimal point and polarity display
- 3 **MAN:** *Low-resistance measurement:*
manual measuring range selection active
- 4 **Rlo:** *Low-resistance measurement:*
special case for automatic low-resistance measurement with measurement in both directions of current flow: both measured values are displayed where $\Delta Rlo > 10\%$
- 5 *Low-resistance measurement:*
polarity reversal display (reversed current flow direction) $\Omega \rightarrow$ or $\leftarrow \Omega$
- 6 Analog display pointer: bar graph or pointer, see A.diSP parameter on page 12
Triangle at display: indicates overranging
- 7 **DC/AC:** Selected current type
- 8 **ISO xxxV:** *Insulation resistance measurement: selected test voltage*
- 9 **$\Omega \text{ V}$:** Unit of measure
- 10 **ZERO:** Cable compensation for low-resistance measurement is active, see rLEAd parameter on page 11
- 11 **DATA:** *Blinks* during measurement
Static: measured value is stable
- 12  Warning regarding dangerous voltage:
 $U > 50 \text{ V AC/DC}$
- 13  Acoustic signal (beeper) active for exceeded limit values, see bBEEP parameter on page 12
- 14 **ON** Instrument is continuously on (except with switch in OFF position), see APOFF parameter on page 12

Contents	Page	Contents	Page
1 Applications	7	Insulation Measuring Instrument	23
2 Safety Features and Precautions	8	10 Characteristic Values	24
3 Initial Start-Up	9	11 List of Abbreviations and their Meanings	28
3.1 Battery test	9	12 Maintenance	28
3.2 Installing or Replacing Batteries	9	12.1 Battery and Rechargeable Battery Operation	28
3.3 Query and Set Device Parameters – SETUP Function	10	12.2 Fuses	29
3.3.1 Paths to the Various Parameters	10	12.2.1 Fuse Link – FUSE Message	29
3.3.2 Querying Parameters – InFo Menu (as moving letters)	11	12.2.2 Electronic Fuse	30
3.3.3 Entering Parameters – Set Menu	11	12.3 Housing	30
3.3.4 Default Settings	13	13 Recalibration	30
4 General Operation	14	14 Appendix	31
4.1 Switching On, Monitoring and Switching Off	14	14.1 Sample Connection Layouts for Insulation Resistance Measurement	31
4.2 Measured Value Display	15	14.2 Attaching the strap to the test instrument	34
5 Measuring Insulation Resistance – R_{iso}/R_{ins} Function	16	14.3 Attaching the Test Probe Holder to the Carrying Strap	34
5.1 Connection	16	14.4 Technical Data for Measurement Cables (scope of delivery: KS17-4 safety cable set)	35
5.2 Performing the Measurement	16	14.5 Optional Accessories (not included)	36
5.3 Ending the Measurement	17	14.5.1 Application Test Probe for Remote Triggering (Option Z550A)	36
6 Measuring Direct, Alternating and Pulsating Voltage – V Function	18	15 Repair and Replacement Parts Service Calibration Center and Rental Instrument Service	37
7 Measuring Resistance – $k\Omega/\Omega$ Function (METRISO BASE/TECH)	19	16 Product Support	37
8 Measuring Low-Value Resistance (up to 10 Ohm) – R_{LO} Function	20		
8.1 Measurement with Automatic Polarity Reversal – AUTO Function	21		
8.2 Measurement with Manual Polarity Reversal – MAN Function	22		
8.3 Taking Measurement Cables and Extension Cables into Account (up to 10 Ohm) – ZERO Function (Roffset)	23		
9 Test Resistor for Insulation Measurement for Checking the			

1 Applications

These instruments fulfill all requirements of applicable European and national EC directives. We confirm this with the CE mark. The relevant declaration of conformity can be obtained from GMC-I Messtechnik GmbH.

METRISO INTRO/BASE/TECH insulation and resistance measuring instruments allow for quick and efficient testing of protective measures in accordance with DIN VDE 0100, ÖVE-EN 1 (Austria), NIV/NIN SEV 1000 (Switzerland), and regulations specific to additional countries.

The device is equipped with a microprocessor and complies with IEC/EN 61 557 / VDE 0413 regulations:

- Part 1: General requirements
- Part 2: Insulation resistance measuring instruments
- Part 4: Instruments for the measurement of resistance at earthing conductors, protective conductors and bonding conductors
- Part 10: Combined measuring equipment for testing, measuring or monitoring protective measures

As well as requirements per VDE 0701-0702:
Repair, modification and inspection of electrical appliances.

The test instrument is especially well suited for:

- Systems set-up
- Initial start-up
- Periodic testing
- Troubleshooting in electrical systems

The following measurements and tests can be performed with the insulation measuring instruments:

- Insulation resistance
- Low-resistance
- Voltage

The following can also be tested by using a shielded measurement cable:

- Floor covering electrostatic discharge capability

2 Safety Features and Precautions

The electronic measuring and test instrument is manufactured and tested in accordance with safety regulations IEC/EN 61010-1 / VDE 0411-1 and EN 61557. When used for its intended purpose, safety of the operator, as well as that of the instrument, is assured.

Read the operating instructions thoroughly and carefully before using your instrument. Follow all instructions contained therein.

The measuring and test instrument may not be placed into service:

- If the battery compartment lid has been removed
- If external damage is apparent
- If connector cable or measuring adapters are damaged
- If the instrument no longer functions flawlessly
- After extraordinary damage due to transport
- After long periods of storage under unfavorable conditions (e.g. humidity, dust or extreme temperature)

Opening of Equipment / Repair

The equipment may be opened only by authorized service personnel to ensure the safe and correct operation of the equipment and to keep the warranty valid.

Even original spare parts may be installed only by authorized service personnel.

In case the equipment was opened by unauthorized personnel, no warranty regarding personal safety, measurement accuracy, conformity with applicable safety measures or any consequential damage is granted by the manufacturer.

Meaning of Symbols on the Instrument



Warning concerning a source of danger (attention: observe documentation!)



Protection class II device

CAT II / III

Device assigned to measuring categories METRISO INTRO/TECH:
CAT II 1000 V / CAT III 600 V / CAT IV 300 V
METRISO BASE:
CAT III 600 V / CAT IV 300 V



EC mark of conformity



The device and included batteries may not be disposed of with the trash. Further information regarding the WEEE mark can be accessed on the Internet at www.gossenmetrawatt.com by entering the search term "WEEE".

Calibration Seal (blue seal):

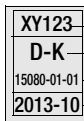

Consecutive number

Deutsche Akkreditierungsstelle GmbH – calibration lab

Registration number

Date of calibration (year – month)

See also "Recalibration" on page 30.

3 Initial Start-Up

3.1 Battery test

Four different battery symbols, ranging from fully depleted to fully charged, continuously indicate the momentary charge level in the upper left-hand corner of the display

If battery voltage has fallen below the allowable lower limit, the pictograph shown at the right appears. The instrument does not function if the batteries have been depleted excessively, and no display appears.



3.2 Installing or Replacing Batteries

New batteries must be inserted for initial start-up, or **if only one filled segment remains in the battery symbol**.



Attention!

Before opening the battery compartment (see page 5 for location), disconnect the instrument from the measuring circuit (mains) at all poles.

Eight 1.5 V size AA batteries in accordance with IEC LR 6 are required for operation of the insulation measuring instrument. Use new alkaline manganese batteries only.

Rechargeable NiCd or NiMH batteries may also be used. These can only be recharged externally. We recommend rechargeable NiMH batteries.

Always replace batteries in complete sets.

Dispose of batteries in an environmentally sound fashion.

- ⇨ Loosen both slotted screws for the battery compartment lid on the back, and remove the lid.
- ⇨ Remove the battery holder and insert eight 1.5 V size AA batteries with correct polarity in accordance with the symbols.



Attention!

Make sure that all of the **batteries are inserted with correct polarity**. If just one battery is inserted with reversed polarity, it will not be recognized by the instrument and may result in leakage from the batteries.

- ⇨ Push the battery holder into the battery compartment such that the battery holder's contacts touch the contact springs at the bottom of the battery compartment (see drawing on page 3).
If the battery holder is not inserted as specified, the instrument cannot be supplied with power.
- ⇨ Replace the battery compartment lid and retighten the screws.



Attention!

The instrument may only be placed into service if the battery compartment lid is securely fastened!

3.3 Query and Set Device Parameters – SETUP Function

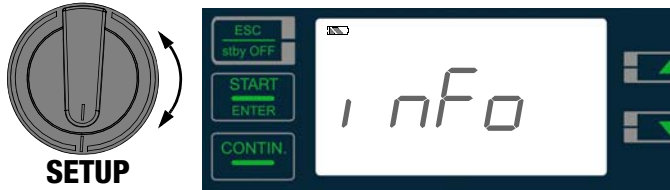

- ⇨ Turn the rotary switch to the **SETUP** position.
 - Info* appears at the display.
 - ⇨ Press **ENTER** to query battery voltage or firmware version.
 - ⇨ Then select the desired operating parameters with the scroll keys and acknowledge by pressing the **ENTER** key.
- The desired information is displayed in the scroll mode (moving letters).

3.3.1 Paths to the Various Parameters

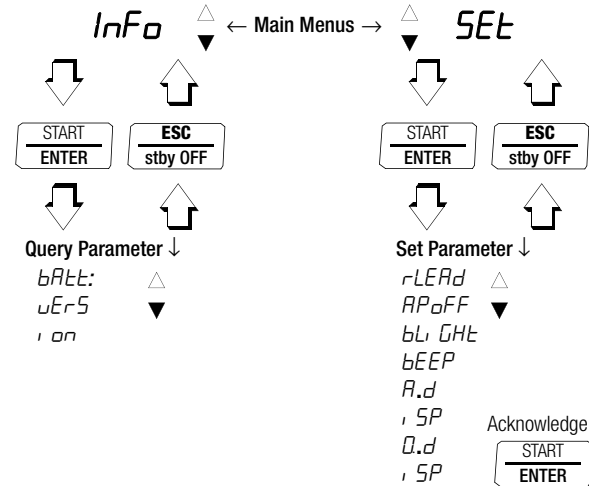

List of all parameters (alphabetical order)

Parameter	Page: Header
<i>0.d, SP</i>	13: 0.diSP – Show/Hide Leading Zeros
<i>R.d, SP</i>	12: A.diSP – Analog Display: Select Display Mode
<i>APoFF</i>	12: APoFF – Specified Time for Automatic Shutdown and Continuous ON
<i>bAtt</i>	11: bAtt – Query Battery Voltage
<i>bEEP</i>	12: bEEP – Acoustic Indication of Exceeded Limit Values
<i>bLi GHt</i>	12: bLiGt – Switching LCD Illumination On/Off
<i>CoP</i>	For service purposes only
<i>InFo</i>	11: Querying Parameters – InFo Menu (as moving letters)
<i>Li LEd</i>	13: LiLEd – Optical Indication of Limit Value Violations
<i>SEt</i>	11: Entering Parameters – SEt Menu
<i>vErS</i> <i>ion</i>	11: vErSion – Query Firmware Version
<i>rLEAd</i>	11: rLEAd – Offset Resistance for Low-Resistance Measurement

3.3.2 Querying Parameters – InFo Menu (as moving letters)

bAtt – Query Battery Voltage

InFo  *bAtt: 12.05 V.*

vErSion – Query Firmware Version



InFo  *bAtt: ▽ vErS, ion: 1.0.0*

3.3.3 Entering Parameters – SEt Menu

rLEAd – Offset Resistance for Low-Resistance Measurement

Measurement cable ohmic resistance can be subtracted from the measurement results automatically. Offset must be determined and saved to memory via the *rLEAd* parameter to this end.

- Connect the measurement cables to the + and **COM** jacks.
- Short circuit the two test probes connected to the measurement cables (including extension cables).
- Select the *rLEAd* parameter and acknowledge by pressing the **ENTER** key. Select *ZEro* and acknowledge by pressing the **START** key in order to trigger measurement of offset resistance:

InFo ▽ *SEt*  *rLEAd* 
ZEro / *CLEAr* Δ ▽ 

Low-resistance measurement as described in section 8.1 is conducted in both directions with automatic polarity reversal.



Note

If the test probes are not short circuited, the **Short LEAdS** prompt appears at the display.

The measurement results, i.e. the resistance of the two measurement cables, are subtracted from future low-resistance measurements as an offset value, and **ZERO** appears in the footer.

After selecting the *CLEAr* parameter and acknowledging by pressing the **ENTER** key, you're provided with the opportunity of performing future measurements without using the offset. If this is the case, **ZERO** is no longer displayed. In this case, measurement cable resistance is included in the measurement.

APoFF – Specified Time for Automatic Shutdown and Continuous ON

Shutdown time *APoFF* can be specified with this parameter. The instrument is switched off automatically if the measured value remains unchanged for a long period of time and if none of the keys or the rotary switch have been activated before specified *APoFF* time (entered in minutes) has elapsed.

The selected on-time has as substantial influence on battery service life.

If the *on* setting is selected, the instrument is set for long-term measurement and **ON** appears at the display to the right of the battery symbol. In this case, the instrument can only be switched off manually.

InFo ▽ *SEt* START
ENTER *rLEAd* ▽ ... ▽ *APoFF*

START
ENTER *10 ... 59 min on* Δ ▽ START
ENTER

(10 minutes = default setting)

bLiGt – Switching LCD Illumination On/Off

Automatic deactivation of display illumination after xx seconds (after the last time the rotary switch is actuated) can be selected in order to extend the battery service life. As soon as a new measuring function is selected or started, illumination is reactivated. When set to *oFF*, illumination is permanently deactivated.

InFo ▽ *SEt* START
ENTER *rLEAd* ▽ ... ▽ *bLiGt*

START
ENTER *15 / 30 / 45 / 90 s oFF* Δ ▽ START
ENTER

(15 seconds = default setting)

bBEEp – Acoustic Indication of Exceeded Limit Values

This parameter allows you to decide whether or not exceeded limit values will be indicated acoustically.

on = acoustic indication activated

InFo ▽ *SEt* START
ENTER *rLEAd* ▽ ... ▽ *bBEEp*

START
ENTER *on / oFF* Δ ▽ START
ENTER

(*on* = default setting)

A.diSP – Analog Display: Select Display Mode

One of two different display modes can be selected for the analog display:

- *bARrG*: bar graph
- *POiNt*: pointer

InFo ▽ *SEt* START
ENTER *rLEAd* ▽ ... ▽ *A.diSP*

START
ENTER *bARrG / POiNt* Δ ▽ START
ENTER

(*POiNt* = default setting)

0.diSP – Show/Hide Leading Zeros

This parameter determines whether or not leading zeros will appear in the measured value display.

Info ▾ *SEt*

START
ENTER

rLEAd ▾ ... ▾ *0.di SP*

START
ENTER

0000.0: with leading zeros (default value)

0.0: leading zeros suppressed

△ ▾

START
ENTER

LiLEd – Optical Indication of Limit Value Violations

This parameter allows you to decide whether or not limit value violations will be indicated optically.

on = optical indication activated

Info ▾ *SEt*

START
ENTER

rLEAd ▾ ... ▾ *LiLEd*

START
ENTER

on / oFF △ ▾

START
ENTER

(on = default setting)

3.3.4 Default Settings

Previously entered changes can be undone, and default settings can be restored. This may be advisable under the following circumstances:

- After the occurrence of software or hardware errors
- If you are under the impression that the instrument does not work correctly
- ⇒ Disconnect the device from the measuring circuit.
- ⇒ Briefly remove the batteries (see also section 3.2).
- ⇒ Press and hold the

ESC
stby OFF

 key,
and reinsert the batteries.

After hearing two acoustic signals, the instrument has been restored to its default settings.

4 General Operation

The test leads are connected to the “+” and “COM” jacks.

Measuring High-Value Resistance with the KS-C Probe (Option)

When measuring electrostatic discharge capacity for floor coverings, the shielded cable should also be connected to the **COM** and **SHIELD** jacks (KS-C accessory set, “cable set consisting of measurement cable and high-resistance measurement cable for measurements in the $G\Omega$ range”, see diagram). Be sure to observe color coding.

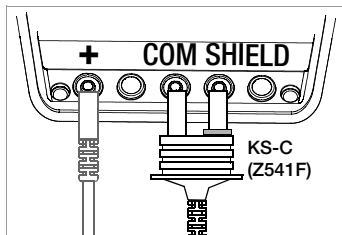

For measuring with the Test Probe for Remote Triggering (Option Z550A) see section 14.5.1.

4.1 Switching On, Monitoring and Switching Off

If battery voltage falls below the allowable limit value ($U < 8\text{ V}$) the instrument cannot be switched on, or it is immediately switched off.





Measurement cannot be started in the resistance measuring ranges in the event of external voltage.

The instrument only switches itself off automatically after completion of an automatic measuring sequence, and after the predetermined on-time has expired (**APOFF** parameter in **SETUP** switch position, see page 12). On-time is reset to its original value as defined in the setup menu, as soon as any key or the rotary function switch is activated.

If the instrument is switched off automatically with the rotary switch in any position other than **OFF**, it can be reactivated by pressing the **stby OFF** key.

The instrument can be switched off manually by turning the rotary switch to the **OFF** position.

Optical Indicators

LED	Status	Function – Cause
	Green	Limit value indication ¹ <ul style="list-style-type: none"> Measured insulation resistance does not violate the limit value. Measured low-resistance Rlo does not violate the limit value.
	Red	Limit value indication ¹ <ul style="list-style-type: none"> Measured insulation resistance has fallen short of the selected limit value. Measured low-resistance Rlo does has exceeded the permissible limit value.
	Red	External voltage when on or off (not M550N) and during discharge ² Dangerous voltage of greater than 50 V is present at the measurement inputs: <ul style="list-style-type: none"> Initialization of the (insulation) resistance and low-resistance measurements is disabled. The discharging cycle has not yet been completed, e.g. residual voltage at capacitive devices under test Test/Measuring voltage with device switched on Dangerous voltage of greater than 50 V is present at the measurement inputs.
LCD	Status	Functions
	Display	External voltage when off, and during discharge Dangerous voltage of greater than 50 V is present at the measurement inputs: <ul style="list-style-type: none"> Initialization of the insulation resistance and low-resistance measurements is disabled. Test voltage applied during insulation measurement The discharging cycle has not yet been completed, e.g. residual voltage at capacitive devices under test

¹ Prerequisite: The LiLED parameter is set to on (see page 13).

² Function testing should be executed regularly (see following section on testing LEDs).

Testing the LED which Indicates the Detection of External Voltage when Switched Off – OFF Switch Position

- ⇨ Apply a voltage of greater than 50 V (+ and COM jacks).
- ⇨ Turn the rotary switch to the V position.
- ⇨ Read the voltage value at the LCD.
- ⇨ Turn the rotary switch to the OFF position.

Test results: If applied voltage is unchanged and the LED which indicates the detection of external voltage lights up red, the LED is OK. In this case, the LED reliably indicates external voltage even when the instrument is switched off. We recommend executing this test at regular intervals.

Limit Values for Insulation and Low-Resistance Measurements

Limit 	METRISO	INTRO	BASE	TECH
		(M550N)	(M5500)	(M550P)
Limit R_{ISO} / R_{INS}	50 k Ω @ $U_{ISO}/U_{INS} = 50$ V	—	✓	✓
	100 k Ω @ $U_{ISO}/U_{INS} = 100$ V	—	✓	✓
	500 k Ω @ $U_{ISO}/U_{INS} = 250$ V	✓	✓	✓
	1 M Ω @ $U_{ISO}/U_{INS} = 500$ V	✓	✓	✓
	1 M Ω @ $U_{ISO}/U_{INS} = 1000$ V	✓	—	✓
Limit R_{LO}	2 Ω	✓	✓	✓

Acoustic Signals

Limits can also be indicated acoustically by setting the **bEEP** parameter to **on** (see page 12).

The loudspeaker symbol  appears in this case.

- Low-Resistance Measurement: Signal when $R_{LO} < 2 \Omega$ (Continuity test)
- Insulation Measurement: Signal when $R_{INS} < \text{limit value}$

4.2 Measured Value Display

The following appear at the LCD panel:

- Measured value in digital format
- Measured value in analog format as bar graph or pointer
- Unit of measure

Measured values for automatic measuring sequences are retained at the display as digital values until the next measurement sequence is started, or until automatic shut-off occurs.

If the upper range limit is exceeded, **OL** appears at the display, thus indicating overranging.

If the lower range limit is fallen short of, **uF** appears at the display, thus indicating underranging.

Either a bar graph or a pointer can be selected for the analog display (see **AdiSP** parameter on page 12).

5 Measuring Insulation Resistance – Riso/Rins Function

5.1 Connection



Note

Checking the Measurement Cables

Before performing insulation measurement, the test probes on the measurement cables should be short-circuited in order to assure that the instrument displays a value very close to 0Ω (see section 8). This makes it possible to detect interrupted measurement cables, which simulate high insulation resistance.

For this instrument, **fuse testing** is only performed after switching from one insulation resistance measuring range to another. When further measurements are performed in the same measuring range, fuse testing is dispensed with for the sake of a faster test procedure.

- ⇨ Connect the device under test to the + and **COM** jacks.

Sample connection layouts for insulation resistance measurement are included in section 14.1. Insulation resistance can only be measured at voltage-free objects. If mains voltage or external voltage is applied to the measurement inputs, measurement cannot be started. This is indicated by the **high-voltage symbol** which appears at the display.

5.2 Performing the Measurement

Note: Condensation must be ruled out when performing measurements at close to the freezing point.

- ⇨ Select the measuring function and the desired test voltage with the rotary switch, e.g. $R_{ISO} 100V$.

The momentarily selected test voltage (nominal voltage) appears in the bottom right-hand corner of the display.

- ⇨ Start an individual measurement by briefly pressing the **START** key, or initiate continuous measurement by briefly pressing the **CONTIN** key.

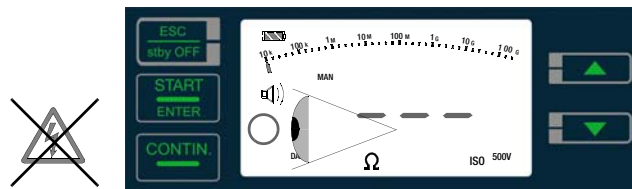
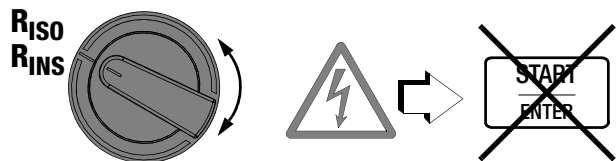
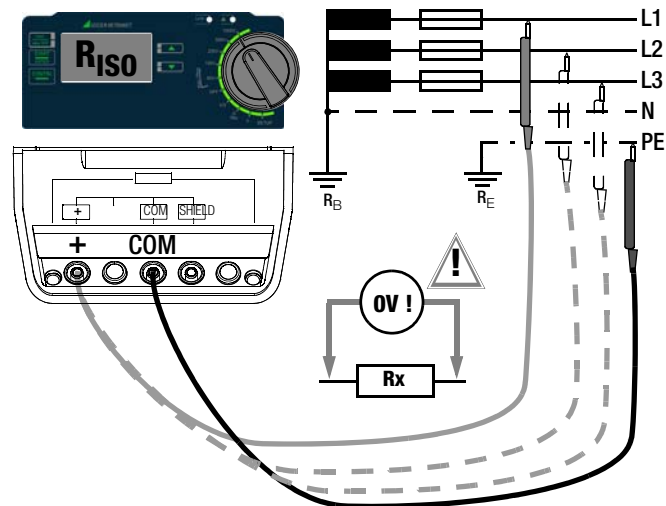



DATA blinks at the display until the measured value has settled in.



Attention!

Do not touch the instrument's terminal contacts during insulation resistance measurements!

If nothing has been connected to the terminal contacts, or if a resistive load component has been connected for measurement, your body would be exposed to a current of approximately 1 mA at a voltage of 1000 V. The resulting electrical shock is not life endangering. However, the noticeable shock may lead to injury (e.g. resulting from a startled reaction etc.).



Note

Three-Phase Systems

All conductors (L1, L2, L3 and N) must be measured against PE!



Note

The instrument's batteries are exposed to excessive stress during insulation resistance measurement. For this reason it's advisable to perform individual rather than continuous measurements.

5.3 Ending the Measurement

Individual measurement: Measurement is ended automatically as soon as the measured value has settled in.

Continuous measurement is ended by briefly pressing the **ESC** key.

In either case, the measured value is retained at the 7-segment display. When discharging begins, the unit of measure for the bar graph changes from Ω to V. The length of the bar graph is continuously reduced as voltage at the device under test drops.

Special Case: Capacitive Devices Under Test



Caution!

If measurement is performed at a capacitive object such as a long cable, it becomes charged with up to approx. 1000 V (test voltage)! Touching such objects is life endangering!

When an insulation resistance measurement has been performed on a capacitive object it is automatically discharged by the instrument. Contact between the object and the instrument must nevertheless not be interrupted. Do not disconnect until:

- The **caution LED (> 50 V)** is no longer illuminated
- The **high-voltage symbol** is no longer displayed
- The analog **bar graph** has dropped to a value of less than 50 V

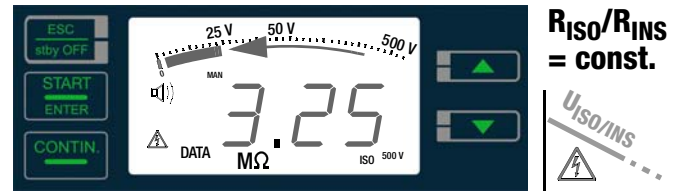

6 Measuring Direct, Alternating and Pulsating Voltage – V Function

You can measure direct voltage, as well as sinusoidal alternating voltage with frequencies ranging from 45 to 65 Hz with this test instrument.

- Select the V measuring function with the rotary switch.
- Select the desired voltage type with the scroll keys: direct voltage (DC), alternating voltage (AC TRMS) or pulsating voltage (DC + AC TRMS)
- Connect the measurement cables to the + and **COM** jacks.
- Contact the measuring point with both test probes.

The measured value is displayed directly (without pressing the **START** key) in analog format at the bar graph and in digital format at the 7-segment display.

- After completing the measurement, switch the instrument off by turning the rotary switch to the **OFF** position.

The **ESC**, **START** and **CONTIN.** keys are disabled in this case.

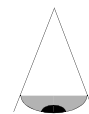
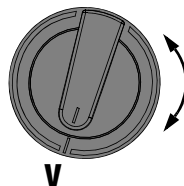
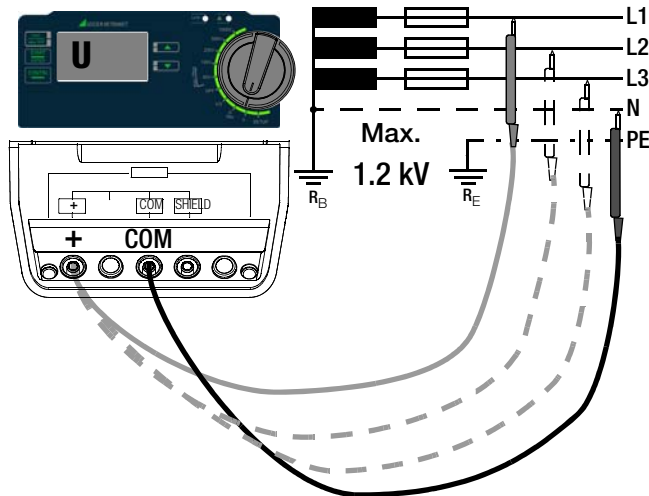

Note

Input impedance for the voltage measuring range is 10 M Ω .



7 Measuring Resistance – k Ω / Ω Function (METRISO BASE/TECH)

- Connect the device under test to the + and COM jacks.

Resistance can only be measured at voltage-free objects. If mains voltage or external voltage is applied to the measurement inputs, measurement cannot be started.

This is indicated by the **high-voltage symbol** which appears at the display.

- Select measuring function k Ω or Ω with the rotary switch.
- Start an individual measurement by briefly pressing the **START** key, or initiate continuous measurement by briefly pressing the **CONTIN** key.

DATA blinks at the display until the measured value has settled in.

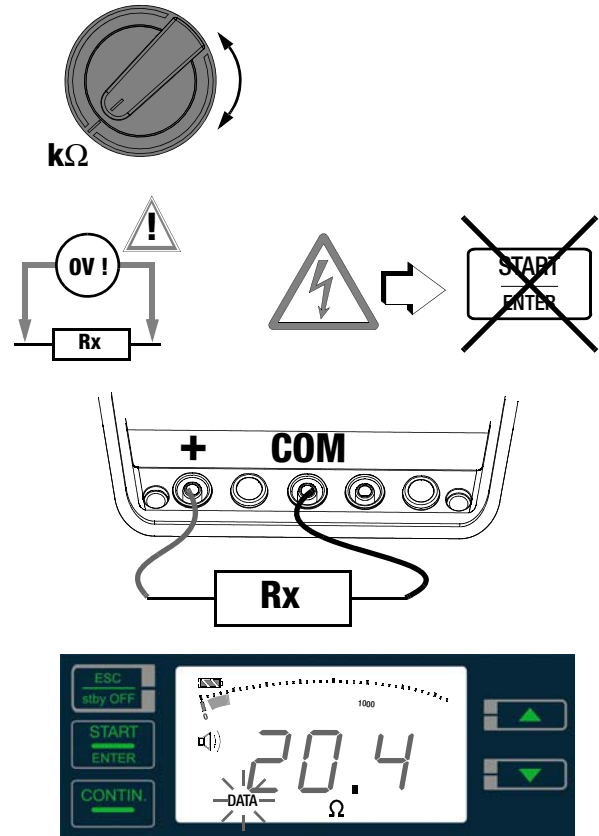

8 Measuring Low-Value Resistance (up to 10 Ohm) – R_{LO} Function

According to the regulations, the measurement of low-value resistance at protective conductors, earth conductors or equipotential bonding must be performed with (automatic) polarity reversal of the test voltage, or with current flow in one or the other direction.



Attention!

In the measuring function R_{LO}, measurements are performed with **currents about 200 mA**.

Please check before measuring whether your DUT or your circuit is designed for these high current values.

Connection



Note

Low-value resistance can only be measured at voltage-free objects.

- Connect the device under test to the **+** and **COM** jacks.
- Select the **Rlo** measuring function with the rotary switch.



Attention!

The measurement cannot be started until the test probes are in contact with the device under test.

If voltage is present at the device under test ($U > 10\text{ V}$), the display is switched to voltage measurement. The display is not returned to low-resistance measurement until voltage is less than approximately 8 V. If resistance is greater than 10 Ω , **OL** pears at the display.

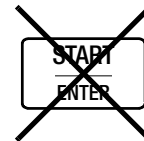
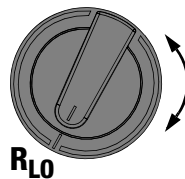
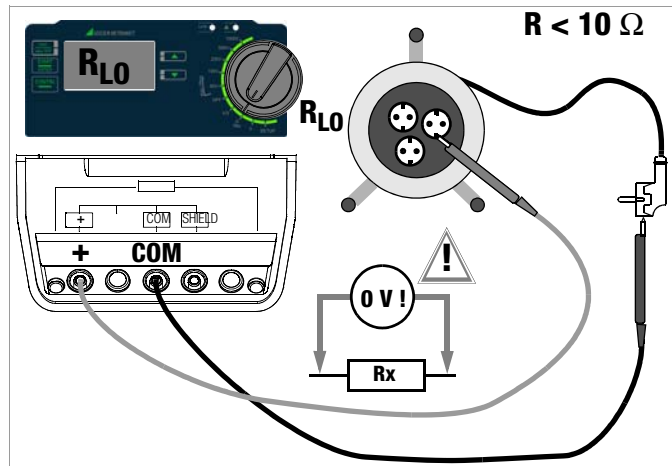

Measurement Types

You can choose one of two different types of measurement:

- Measuring sequence with automatic polarity reversal (reversal of current flow direction)
- Manual measurement with specified current flow direction

8.1 Measurement with Automatic Polarity Reversal – AUTO Function

Automatic polarity reversal is selected as a default value. **MAN** does **not** appear at the display.

- ◊ Start measurement in both current flow directions by briefly pressing the **START** key for one-time polarity reversal or start continuous measurement for permanent polarity reversal by briefly pressing the **CONTIN.** key.

After the measuring sequence has been started, the instrument performs measurement with automatic polarity reversal, first with current flow in one direction ($\Omega \rightarrow$), and then in the other ($\leftarrow \Omega$). **DATA** blinks at the display until the measured value has settled in. The larger (worst) measured value is displayed. $\leftarrow \Omega \rightarrow$ appears at the display.

Difference > 10%

If, during measurement with automatic polarity reversal, the difference between $\Omega \rightarrow$ and $\leftarrow \Omega$ is greater than 10%, the resistance values for both polarities (current flow directions) are displayed separately (separated by an underscore). $\Delta R_{Lo} > 10\%$ appears at the display.

Limit Value Indication

If the measured value is less than or equal to 2Ω , the **Limit** LED lights up green. If the measured value is greater than 2Ω , the LED lights up red. As a prerequisite, the **LiLED** parameter must be set to “on” (see page 13).

Resistances which do not demonstrate a stable value until after a “settling in period” should not be measured with automatic polarity reversal. Measurement with automatic polarity reversal may

lead to varying and/or inflated measurement values, and thus to an ambiguous reading.

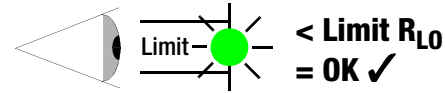

AUTO: $\Omega \rightarrow$ $\leftarrow \Omega$ $\Delta R_{Lo} \leq 10\% ? \leftarrow \Omega \rightarrow$
 $\Delta R_{Lo} > 10\% ? \leftarrow \Omega \ \& \ \Omega \rightarrow$



8.2 Measurement with Manual Polarity Reversal – MAN Function

In order to determine whether or not the obtained results are independent of current flow direction, measurement can be performed separately for both directions.

- ⇨ Press the $\Delta \nabla$ scroll keys to this end, depending upon the desired current flow direction:
MAN and $\Omega \rightarrow$ or **MAN** and $\leftarrow \Omega$ appear at the display.
- ⇨ Start an individual measurement by briefly pressing the **START** key, or initiate continuous measurement by briefly pressing the **CONTIN** key.

DATA blinks at the display until the measured value has settled in.

Differing results indicate voltage at the device under test (e.g. thermovoltage or unit voltages).

Measurement results can be distorted by parallel connected impedances at load current circuits and by equalizing current, especially in systems which make use of “overcurrent protection devices” (previous neutralization) without an isolated protective conductor. Resistances which change during measurement (e.g. inductance), or a poor contact, can also cause distorted measurements.

Examples of resistances whose values may change during measurement include:

- Incandescent lamp resistance with changing values caused by warming due to measuring current
- Resistances with a large inductive component

In order to assure unambiguous measurement results, causes of error must be located and eliminated.

MAN: Rlo $\Omega \rightarrow$
MAN: Rlo $\leftarrow \Omega$

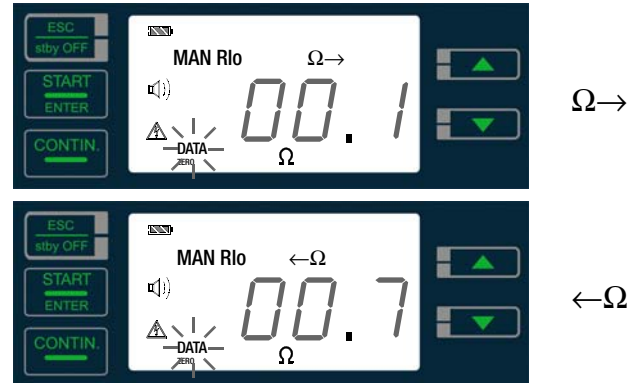

8.3 Taking Measurement Cables and Extension Cables into Account (up to 10 Ohm) – ZERO Function (Roffset)

Measurement cable ohmic resistance can be subtracted from the measurement results automatically. Proceed as follows:

- With the switch in the **SETUP** position and the **SET** menu at the display, select the **rLEAd** parameter. Refer to page 11 for further instructions.

During future low-resistance measurements for which cable resistance is to be taken into account, ZERO appears at the display and cable resistance R_{Offset} is subtracted. Perform low-resistance measurement as described above in the preceding pages.



Note

The cable resistance R_{Offset} which is stored in menu **SET** under parameter **rLEAd** can only be deleted under this parameter by selecting setting **CLEAr**, see page 11.

9 Test Resistor for Insulation Measurement for Checking the Insulation Measuring Instrument

According to section 5.3.1.2 of VDE 0105-100 (EN 50110-1), the following applies: "These measuring instruments must be tested before, and if applicable after use."

The two outermost jacks on the connection panel must be connected to each other internally via a 10 M Ω test resistor to this end.

The sum of test resistor and cable resistance (for both cables), including test probes, amounts to 10 M Ω \pm 5%. This value allows for quick self-testing.

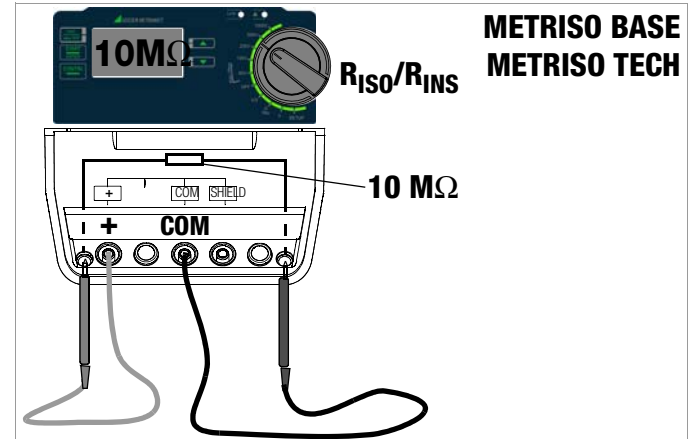

- Connect the measurement cables to the **+** and **COM** jacks.
- Insert the test probes into the above described jacks.
- Select the $R_{\text{ISO/INS}}$ measuring function with the rotary switch, as well as the desired test voltage, e.g. $R_{\text{ISO}} 100\text{V}$.
- Press the start key and view the measurement results.

10 Characteristic Values

Meas. Qty.	UIISO				Range	Measuring Range	Resolution	Open-Circuit Voltage U_{0max}	Test Current	Intrinsic Uncertainty	Measuring Uncertainty	Overload Capacity
RINS	BASE/TECH: 50 V BASE/TECH: 100 V INTRO: 250 V ... 1000 V BASE: 250 V / 500 V TECH: 250 V / 500 V / 1000 V	100 k	10.0 k Ω ... 99.9 k Ω	0.1 k	50 V/100 V: 1.25 U_{ISO} 250 V / 500 V / 1000 V: 1.1 U_{ISO}	$I_N = 1 \text{ mA}$ $I_K \leq 5 \text{ mA}$	$\pm(5\% \text{ rdg.} + 3 \text{ d})$	$\pm(7\% \text{ rdg.} + 3 \text{ d})$	METRISO BASE: 600 V AC/DC TRMS METRISO INTRO METRISO TECH: TRMS			
		1 M	100 k Ω ... 999 k Ω	1 k								
		10 M	1.00 M Ω ... 9.99 M Ω	10 k								
		100 M	10.0 M Ω ... 99.9 M Ω	100 k								
		1 G	100 M Ω ... 999 M Ω	1 M								
		10 G	1.00 G Ω ... 9.99 G Ω	10 M								
		100 G	10.0 G Ω ... 99.9 G Ω	100 M								
200 G	100 G Ω ... 199 G Ω	1 G										
U AC/DC	METRISO BASE METRISO INTRO METRISO TECH	100 V	10.0 V ... 99.9 V	0.1 V	—	—	$\pm(2.5\% \text{ rdg.} + 3 \text{ d})$	$\pm(5\% \text{ rdg.} + 3 \text{ d})$	600 V AC/DC TRMS			
		500 V	100 V ... 510 V ¹⁾	1 V								
		100 V	10.0 V ... 99.9 V	0.1 V								
		1000 V	100 V ... 999 V ²⁾	1 V								
RLO		10 Ω	0.17 ... 9.99 Ω	0.01 Ω	4 V < U_0 < 6 V	200 mA $\leq I$ \leq 260 mA	$\pm(2.5\% \text{ rdg.} + 3 \text{ d})$	$\pm(5\% \text{ rdg.} + 3 \text{ d})$	METRISO BASE: 600 V AC/DC TRMS METRISO INTRO METRISO TECH: 1000 V AC/DC TRMS			
R	METRISO BASE METRISO TECH Display range as of 01.0 Ω	100 Ω	10.0 ... 99.9 Ω	0.1 Ω	$U_0 \text{ max. } 15 \text{ V}$	1 mA $\leq I$ \leq 1,3 mA	$\pm(2.5\% \text{ rdg.} + 3 \text{ d})$	$\pm(5\% \text{ rdg.} + 3 \text{ d})$	METRISO BASE: 600 V AC/DC TRMS METRISO TECH: 1000 V AC/DC TRMS			
1 k Ω	100 ... 999 Ω	1 Ω										
10 k Ω	1.00 ... 9.99 k Ω	10 Ω										

¹⁾ Display range up to 600 V

²⁾ Display range up to 1.2 kV

³⁾ the indicated accuracy is only achieved with the shielded high-resistance measuring cable KS-C (article no. Z541F)*

⁴⁾ does not conform to DIN EN 61557-2

⁵⁾ up to 5 Ω

Reference Conditions

Reference temperature	+ 23 °C ±3 K
Relative humidity	40 ... 75%
Measured quantity frequency	45 Hz ... 65 Hz
Measured quantity waveform	Sine, deviation between TRMS and rectified value < 1%
Battery voltage	9.5 V ±0.1 V
Test resistance	10 MΩ ±1%

Electrical Safety

Standard	
VDE regulation	VDE 0411, part 1, 1994-03
Protection class	II
Pollution degree	2
Measuring category	METRISO INTRO/TECH: CAT II 1000 V / CAT III 600 V / CAT IV 300 V METRISO BASE: CAT III 600 V / CAT IV 300 V
Fuses	
Fuse link	FF315mA/1000V, effective in all resistance measuring ranges, 1 additional replacement fuse in the battery compartment
Elektronic fuse	for protecting low-resistance and resistance measurement R _{LO} and R

Power Supply

Batteries	8 ea. 1.5 V mignon cells (8 ea. size AA) (alkaline manganese per IEC LR14) or 8 rechargeable NiMH batteries (must be recharged externally)
Nominal range of use	8.5 ... 12 V
Battery test	Battery capacity display with battery symbol in 4 segments:  . Querying of momentary battery voltage via menu function.
Battery saver circuit	Automatic shutdown of display illumination after 15 second s (after the last time the rotary switch is actuated) can be set via the <i>BL</i> , <i>GHE</i> parameter. The test instrument is automatically switched to the standby mode* when the measured value remains unchanged and none of the controls are activated during this time. * Specified time " <i>AP_{OFF}</i> " (entered in minutes) adjustable via SETUP menu (default setting approx. 10 min).
Service life	For R _{ISO} (1000 V / 1 MΩ) and R _{LO} with 20 second on-time and 1 measurement each for a duration of 5 seconds – With batteries (alkaline manganese): 900 measurements – With rechargeable batteries (2000 mAh): 850 measurements
Safety shutdown	If supply voltage is too low, the instrument is switched off, or cannot be switched on. When the rotary switch is set to the OFF position, the instrument is completely disconnected from the batteries (after approximately 10 seconds).

Electromagnetic Compatibility (EMC)

Interference emission	EN 61326-1:2006 class B
Interference immunity	EN 61326-1:2006

Ambient Conditions

Accuracy	
temperature range	0 ... +40 °C
Operating temperature	-10 ... +50 °C
Storage temp. range	-25 ... +70 °C (without batteries)
Relative humidity	Up to 75% (max. 85% during storage/transport), no condensation allowed
Elevation	Max. 2000 m
Calibration interval	1 year (recommended)

Mechanical Design

Dimensions	225 x 130 x 140 mm
Weight	Approx. 1.4 kg with batteries
Protection	Housing: IP 52, measurement cables and connectors: IP 40 per DIN VDE 0470, part 1 / EN 60529, housing category 2

Extract from table on the meaning of IP codes

IP XY (1 st digit X)	Protection Against Foreign Object Entry	IP XY (2 nd digit Y)	Protection Against Penetration by Water
2	≥ 12.5 mm dia.	2	Dripping (at 15° angle)
3	≥ 2.5 mm dia.	3	Spraying water
4	≥ 1.0 mm dia.	4	Splashing water
5	Dust protected	5	Jet-water
6	Dust-proof	6	Powerful water jets

Displays

Digital display

With additional bar graph or pointer depending on selection with *R.d.*, *5P* parameter, backlit (transflective); leading zeros can be suppressed at the digital display depending on *D.d.*, *5P* parameter;
overranging indicated with *DL* at display;
dimensions: 65 x 36 mm

Limit LED



LED

LED lights up red to indicate an exceeded limit value
LED lights up green to indicate adherence to the limit value

LED lights up red to indicate:

- the presence of an **external voltage** before insulation testing ($U > 50 \text{ V}$) with the device switched on or off (device switched off not with M550N)
- the presence of the **test/measuring voltage** during (insulation) measurement ($U > 50 \text{ V}$) the presence of a **residual voltage** after insulation testing ($U > 50 \text{ V}$) with the device switched on or off



at LCD

Detection of external voltage at the LCD with the device switched on where $U \text{ DC} > 50 \text{ V}$ and $U \text{ AC} > 40 \text{ V}$ (50 Hz) for all measuring functions

Display Values in Consideration of Measuring Uncertainty

Table for determining minimum display values for insulation resistance in consideration of the instrument's measuring uncertainty.

Limit Value	Minimum Display Value	Limit Value	Minimum Display Value
020 k Ω	025 k Ω		
100 k Ω	111 k Ω	100 M Ω	111 M Ω
200 k Ω	219 k Ω	200 M Ω	219 M Ω
500 k Ω	541 k Ω	500 M Ω	541 M Ω
0.20 M Ω	0.25 M Ω		
0.50 M Ω	0.57 M Ω		
1.00 M Ω	1.11 M Ω	1.00 G Ω	1.11 G Ω
2.00 M Ω	2.19 M Ω	2.00 G Ω	2.19 G Ω
5.00 M Ω	5.41 M Ω	5.00 G Ω	5.41 G Ω
10.0 M Ω	11.1 M Ω	10.0 G Ω	11.1 G Ω
20.0 M Ω	21.9 M Ω	20.0 G Ω	22.6 G Ω
50.0 M Ω	54.1 M Ω	50.0 G Ω	55.9 G Ω

Table for determining maximum display values for low-value resistance in consideration of the instrument's measuring uncertainty.

Limit Value	Maximum Display Value	Limit Value	Maximum Display Value
0.15 Ω	0.11 Ω		
0.20 Ω	0.16 Ω	5.00 Ω	4.72 Ω
0.50 Ω	0.44 Ω	10.0 Ω	9.47 Ω
1.00 Ω	0.92 Ω	20.0 Ω	17.7 Ω
2.00 Ω	1.87 Ω	50.0 Ω	44.7 Ω

Voltage at Device Under Test During Insulation Resistance Measurement

Measuring voltage U_x at the device under test depending upon its resistance R_x at nominal voltage $U_N = 100, 250, 500$ and 1000 V:

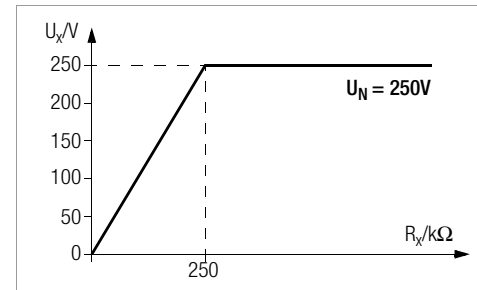
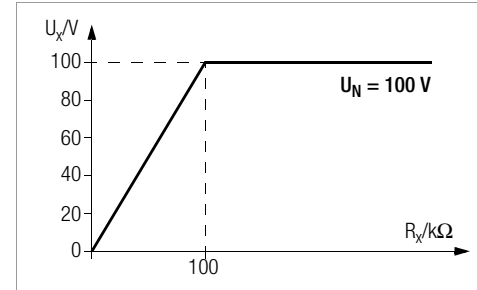

11 List of Abbreviations and their Meanings

Voltage

- U_{ISO} Test voltage or nominal voltage
 $U_{AC/DC}$ Measured voltage (sinusoidal alternating voltage)

Resistance

- LIMIT Limit value for insulation resistance or low-value resistance
Offset Correction value for measurement cable resistance
 R_{ISO} Insulation resistance
 R_{LO} Low-value resistance (cable resistance)

Fuse

- FUSE "Blown fuse" message

12 Maintenance

12.1 Battery and Rechargeable Battery Operation

When only one filled segment remains in the battery symbol, install a new set of batteries or charge the rechargeable batteries. Check to make sure that no leakage has occurred at batteries or rechargeable batteries at short, regular intervals, or after the instrument has been in storage for a lengthy period of time.

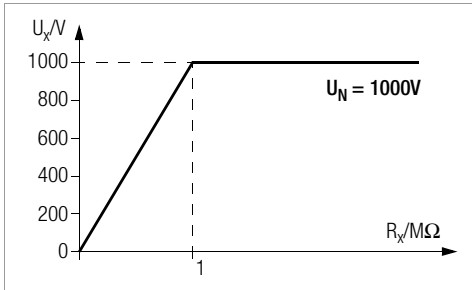
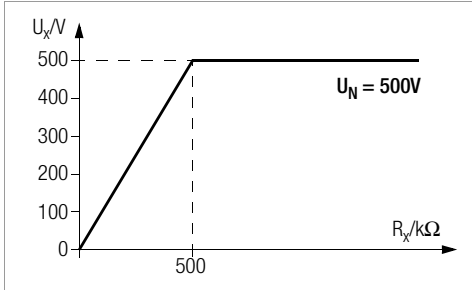



Note

Prior to lengthy periods of rest (e. g. holiday), we recommend removing the (rechargeable) batteries. This helps to prevent excessive depletion or leakage of batteries, which, under unfavourable circumstances, may cause damage to the instrument.

If leakage has occurred, the electrolyte must be carefully and completely removed with a damp cloth before installing new batteries.

Replacing the Batteries

See section 3.2 and section 12.3.

12.2 Fuses

If a fuse has blown due to overload, a corresponding message error appears at the LCD panel. The instrument's voltage measuring ranges are nevertheless still functional.

12.2.1 Fuse Link – FUSE Message

This fuse is active in all resistance measuring ranges except for voltage measurement. A replacement fuse is included in the battery compartment (FF315mA/1000V).



Attention!

Disconnect the instrument from the measuring circuit before opening the battery compartment lid in order to replace the fuse (refer to page 5 for location)!

Checking the Fuse

If a resistance measuring range is selected with the rotary switch with a blown or defective fuse in the instrument, and if the instrument is turned on with the switch in this position, *FUSE* appears at the LCD. Prerequisite: The + and **COM** measurement jacks are not short circuited.

After eliminating the cause of error and replacing the defective fuse, the *FUSE* message is cleared after the instrument has once again been switched on.



Attention!

Severe damage to the instrument may occur if incorrect fuses are used.

Only original fuses from GMC-I Messtechnik GmbH assure required protection by means of suitable blowing characteristics.

Short-circuiting of fuse terminals or the repair of fuses is prohibited!

The instrument may be damaged if fuses with incorrect ampere ratings, breaking capacities or blowing characteristics are used!

Replacing the Fuse

- ⇨ Open the battery compartment lid by loosening the two screws.
- ⇨ Remove the defective fuse and insert a new one. A replacement fuse is included in the battery compartment.
- ⇨ Insert the new fuse.
- ⇨ Replace the battery compartment lid and retighten the screws.

12.2.2 Electronic Fuse

This fuse protects low-resistance (R_{lo}) and resistance measurements (k Ω) from overloading (electronic hardware circuit).

„EL-Fu“ appears when the fuse blows.

- ⇒ Eliminate the cause of overloading. This error message must be cleared by switching to **OFF** position.

12.3 Housing

No special maintenance is required for the housing. Keep outside surfaces clean. Use a slightly dampened cloth or a plastic cleaner for cleaning. Avoid the use of cleansers, abrasives or solvents.

Return and Environmentally Sound Disposal

The **instrument** is a category 9 product (monitoring and control instrument) in accordance with ElektroG (German electrical and electronic device law). This device is subject to the RoHS directive. Furthermore, we make reference to the fact that the current status in this regard can be accessed on the Internet at www.gossenmetrawatt.com by entering the search term WEEE.

We identify our electrical and electronic devices in accordance with WEEE 2012/19/EU and ElektroG using the symbol shown at the right per DIN EN 50419.



These devices may not be disposed of with the trash.

Please contact our service department regarding the return of old devices (see address in section 15).

If you use **batteries** or **rechargeable batteries** in your instrument or accessories which no longer function properly, they must be duly disposed of in compliance with the applicable national regulations.

Batteries or rechargeable batteries may contain harmful substances or heavy metal such as lead (Pb), cadmium (Cd) or mercury (Hg).

The symbol shown to the right indicates that batteries or rechargeable batteries may not be disposed of with the trash, but must be delivered to collection points specially provided for this purpose.



13 Recalibration

The measuring tasks performed with your instrument, and the stressing it's subjected to, influence aging of its components any may result in deviation from the specified levels of accuracy.

In the case of strict measuring accuracy requirements, as well as in the event of use at construction sites with frequent stress due to transport and considerable temperature fluctuation, we recommend a relatively short calibration interval of once per year. If your instrument is used primarily in the laboratory and indoors without considerable climatic or mechanical stressing, a calibration interval of once every 2 to 3 years is sufficient as a rule.

During recalibration* at an accredited calibration laboratory (DIN EN ISO/IEC 17025), deviations from traceable standards demonstrated by your measuring instrument are documented. Ascertained deviations are used to correct displayed values during later use of the instrument.

We would be happy to perform DAkkS or factory calibration for you at our calibration laboratory. Further information is available at our website:

www.gossenmetrawatt.com (→ Company → DAkkS Calibration Center or → FAQs → Question and Answers Regarding Calibration).

Recalibration of your instrument at regular intervals is essential for the fulfillment of requirements according to quality management systems per DIN EN ISO 9001.

* Examination of the specification, as well as adjustment, are not included in calibration. However, in the case of our own products, any required adjustment is performed and adherence to the specification is confirmed.

14 Appendix

14.1 Sample Connection Layouts for Insulation Resistance Measurement

Insulation Resistance Measurement per DIN VDE 0100, Part 600

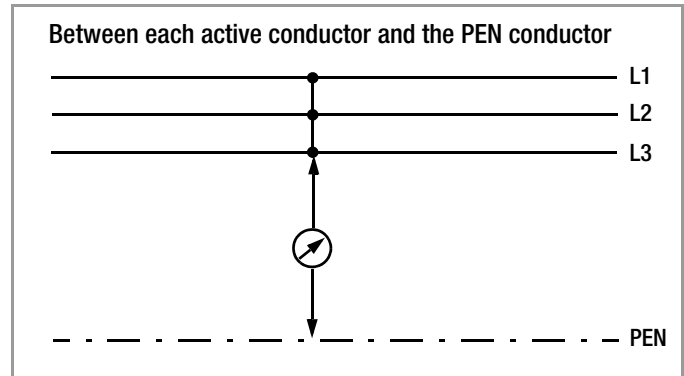
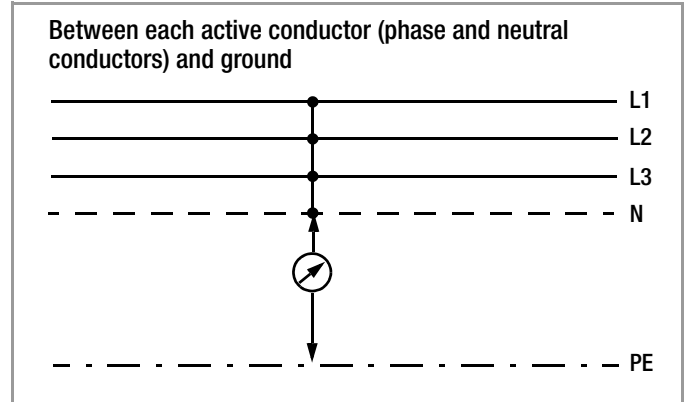
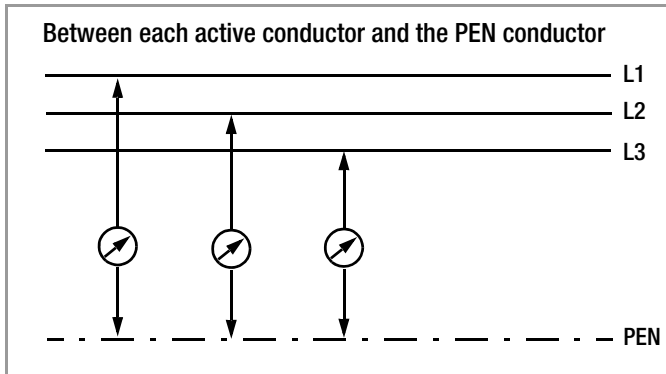
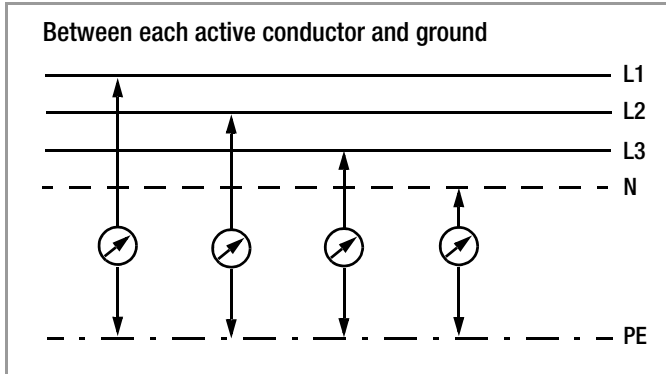

Insulation Resistance Measurement in Different Types of Systems

TN-S

- With or without consumer
- N – PE, separately

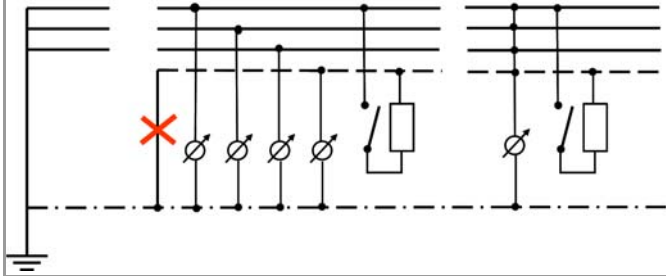

TN-C

- With or without consumer
- N – PE, together

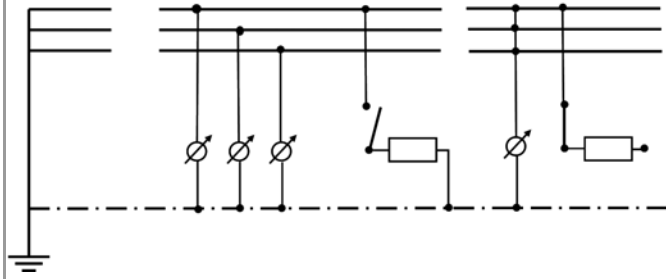

TT

- With or without consumer

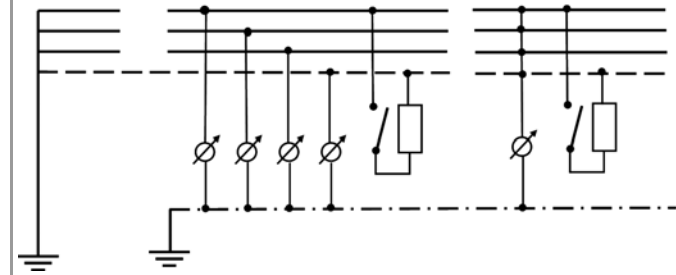

3-phase current (switched at all poles)



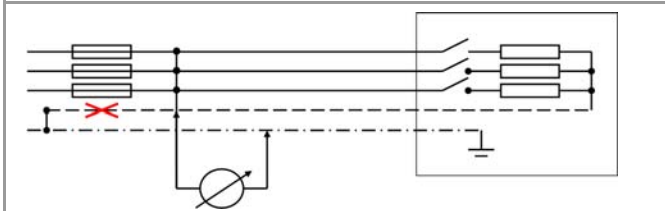

Caution:

- Open the overcurrent protective device
- Disconnect the N conductor
- Jumper the L and N conductors
- Insulation measurement between L conductors and N to PE
- Device switch can be open – if single-pole

In the distributor: individual and combined measurements

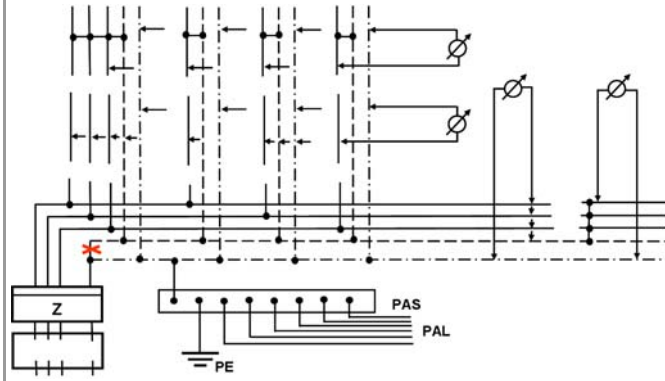

14.2 Attaching the strap to the test instrument

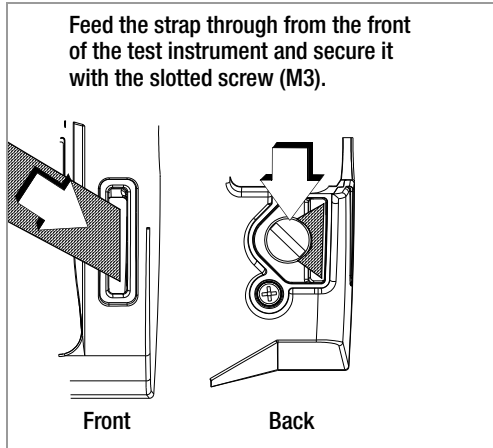

14.3 Attaching the Test Probe Holder to the Carrying Strap

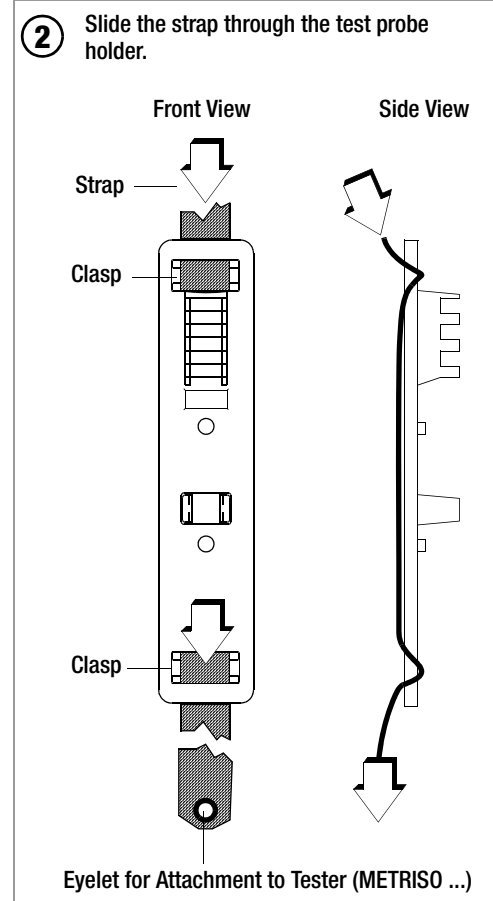
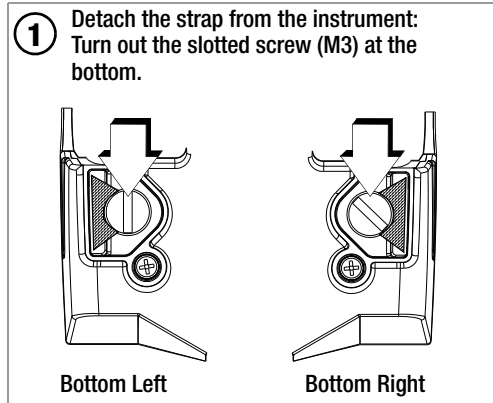

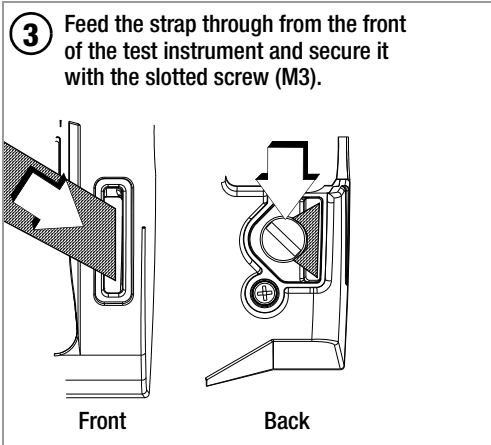

14.4 Technical Data for Measurement Cables (scope of delivery: KS17-4 safety cable set)

Electrical Safety

Maximum rated voltage	600 V	1000 V	1000 V
Measuring category	CAT IV	CAT III	CAT II
Max. rated current:	1 A	1 A	16 A
With safety cap attached	•	•	—
Without safety cap	—	—	•

Ambient Conditions (EN 61010-031)

Temperature	-20 °C ... + 50 °C
Relative humidity	Max. 80%
Pollution degree	2

Using the KS17-4



Attention!

Observe the instrument's maximum values for electrical safety. Measurements per DIN EN 61010-031 may only be performed in environments in accordance with measuring categories III and IV with the safety cap attached to the test probe at the end of the measurement cable.

In order to establish contact inside 4 mm jacks, the safety caps have to be removed by prying open the snap fastener with a pointed object (e.g. the other test probe).

14.5 Optional Accessories (not included)

ISO Calibrator 1 (material no. M662A)

Calibration adapter for testing the accuracy of instruments used for measuring insulation resistance and low-resistance for test voltages up to 1000 V (per VDE 0413, parts 1, 2, 4 and 10)

KS-C (material no. Z541F)

Cable set consisting of measurement cable and shielded high-resistance measurement cable for measurements in the GΩ range

KY95-3 (material no. Z110J) (METRISO BASE/TECH: scope of delivery 1 piece) Alligator clips (1 pair) for KS17-4 and KS-C

1081 probe (material no. GTZ3196000R0001) Triangular probe for floor measurements per EN 1081, DIN VDE 0100-600 (Standing-Surface Insulation)

KS24 (material no. GTZ3201000R0001) Cable set consisting of a 4 m long extension cable with a permanently attached test probe at one end and a contact protected socket at the other end, and 1 alligator clip which can be plugged onto the test probe

Test Probe for Remote Triggering

(material no. Z550A)

Optional plug-on measurement cable with a triggering key on the test probe and an additional key for illuminating the measuring point, including shielded, plug-in connector cable.

14.5.1 Application Test Probe for Remote Triggering (Option Z550A)

When inserting the 3-pole plug, make sure that the jack plug is inserted in the START/STOP position. Press and align the 3-pole plug such that it is placed flush on the connection terminal. This is the only way to assure that the three contacts of the jack plug are properly connected with the command cables.

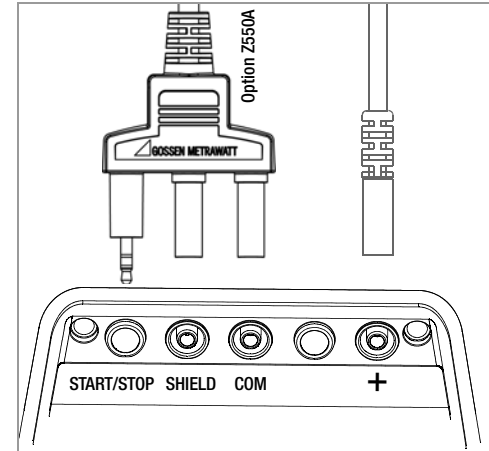

15 Repair and Replacement Parts Service Calibration Center* and Rental Instrument Service

If required please contact:

GMC-I Service GmbH
Service Center
Thomas-Mann-Str. 20
90471 Nürnberg, Germany
Phone: +49 911 817718-0
Fax: +49 911 817718-253
e-mail: service@gossenmetrawatt.com
www.gmci-service.com

This address is only valid in Germany.

Please contact our representatives or subsidiaries for service in other countries.

* **DAkkS Calibration Laboratory for Electrical Quantities D-K-15080-01-01**
accredited per DIN EN ISO/IEC 17025:2005

Accredited quantities: direct voltage, direct current value, direct current resistance, alternating voltage, alternating current value, AC active power, AC apparent power, DC power, capacitance, frequency, temperature

Competent Partner

GMC-I Messtechnik GmbH is certified in accordance with DIN EN ISO 9001:2008.

Our DAkkS calibration laboratory is accredited by the Deutsche Akkreditierungsstelle GmbH (National accreditation body for the Republic of Germany) in accordance with DIN EN ISO/IEC 17025:2005 under registration number D-K-15080-01-01.

We offer a complete range of expertise in the field of metrology: from **test reports** and **proprietary calibration certificates** right on up to **DAkkS calibration certificates**.

Our spectrum of offerings is rounded out with free **test equipment management**.

An on-site **DAkkS calibration station** is an integral part of our service department. If errors are discovered during calibration, our specialized personnel are capable of completing repairs using original replacement parts.

As a full service calibration laboratory, we can calibrate instruments from other manufacturers as well.

16 Product Support

If required please contact:

GMC-I Messtechnik GmbH
Product Support Hotline
Phone: +49 911 8602-0
Fax: +49 911 8602-709
e-mail: support@gossenmetrawatt.com

Edited in Germany • Subject to change without notice • PDF version available on the Internet



GMC-I Messtechnik GmbH
Südwestpark 15
90449 Nürnberg, Germany

Phone: +49 911 8602-111
Fax: +49 911 8602-777
e-mail: info@gossenmetrawatt.com
www.gossenmetrawatt.com