



維弘科技股份有限公司
PROFAN TECHNOLOGY CORP.

Date:2016.2.16

SPECIFICATION FOR APPROVAL

DESCRIPTION: Axial AC Fan

DIMENSIONS: 172x150x51mm

MODEL: P2175HBT-ETS

824 台灣高雄縣燕巢鄉安招村安南二路 50 巷 30 號

NO. 30 Lane50, 2nd Rd., Yanchao ship town,

Kaohsiung Hsien, Taiwan

TEL:(07)6163604

FAX:(07)6169601

Email: sales@profantec.com.tw

Axial AC FAN

MODEL: P2175HBT-ETS

CHARACTERISTICS

- 1. Motor Design : Reliable capacity-run Motor**
- 2. Insulation Resistance : 500Megohms minimum at 500 VDC**
- 3. Dielectric Strength : 1500 VAC for one minute**
- 4. Motor Protection : Thermal or impedance Protected & Class A**
- 5. Noise Level : Measured in a semi-anechoic chamber with background noise level below 15 dB(A). The fan is running in free air with microphone at a distance of one meter from the fan intake.**
- 6. Air Performance : Measured by a double chamber. The Value are recorded when the fan speed is Stable at rated voltage.**
- 7. Tolerances : $\pm 10\%$ on rated power and current.**

SPECIFICATIONS

Model: P2175HBT-ETS

1. Rated Voltage	:	230VAC 50/60Hz
2. Operating Voltage Range	:	210~250VAC
3. Starting Voltage	:	150VAC
4. Rated Speed(±5%)	:	2650/3100 rpm
5. Airflow	:	359/409 m³/h
6. Static Pressure	:	0.55/0.6 in-H₂O
7. Rated Current	:	0.11/0.12 A
8. Power	:	24/26 W
9. Noise	:	55/59 dB
10. Direction of Rotation	:	clockwise viewed front fan blade
11. Connect	:	Terminals(3±0.1mm 2 pin 110 male terminal)
12. Operating Temperature	:	-10 to +70Deg.C
13. Bearing System	:	Bearing System
14. Weight	:	930g
15. Storage temperature/humidity	:	+25~+70Deg.C / 0~45%
16. Operating humidity	:	0 ~ 70%
17. Power wire	:	22 AWG
18. Life expectance in normal environment use	:	20000 hours

PERFORMANCE 50/60Hz

P-Q Curve

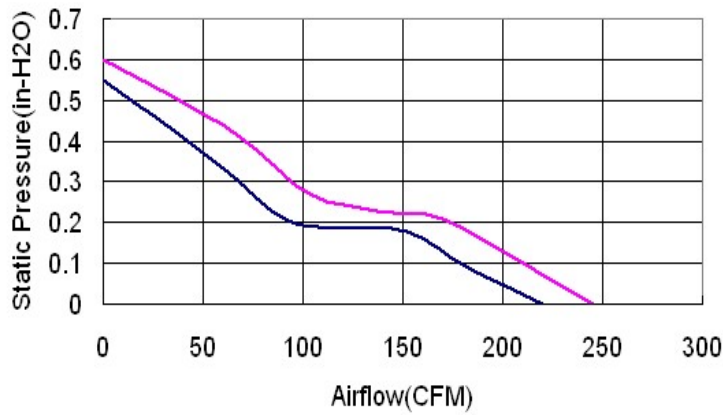

MATERIAL

1. Frame	:	DIE-CAST ALUMINUM
2. Impeller	:	Steel

DIMENSIONS

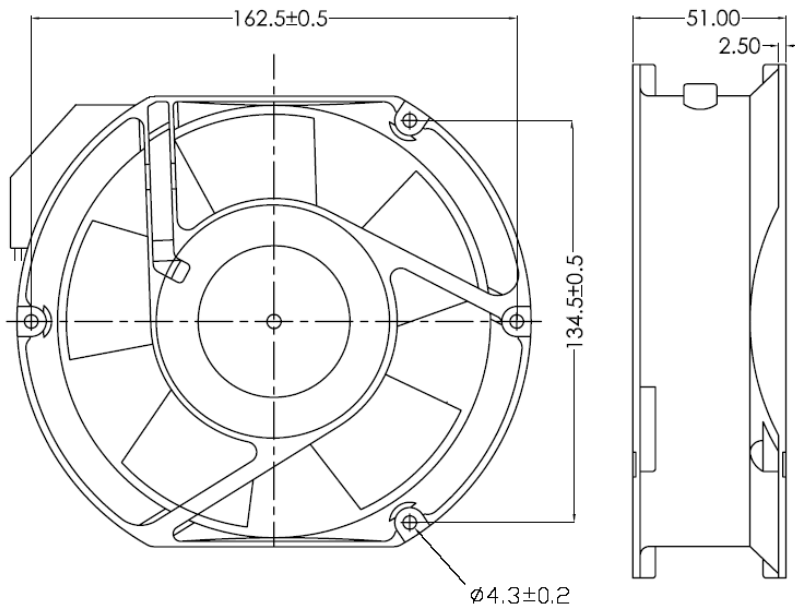

unit: mm

Notes

- 1. The suitability of the motor for use when exposed to water, oil, and chemicals, x-rays ,ultraviolet rays and the like have not been determined.**
- 2. Plastic fan have been proved that don't suit to use UV environment, but steel fan could.**
- 3. The acceptability of the motor leads and terminal assembly should be determined for each application with regard to wire size, temperature limitation and other particular aspects which might be required in the end product.**
- 4. No guarantee on the products against the safety problem or failure caused by power dust, drop of water or insect.**
- 5. Always ensure that fans are stored according to the storage temperature specified. Do not store in an environment with a high humidity level. If the fans were stored for longer than 6 months.**
- 6. Fan must be securely and adequately grounded. This can be accomplished by connecting a separate ground wire to the fan frame with a self-threading screw (not furnished) in the hole provided.**
- 7. Protect the power cable from coming in contact with sharp objects.**
- 8. Lock and tag power disconnect to prevent unexpected application of power.**
- 9. Refer to Profan Catalog or label for a complete list of cordset. Plug cordset into fan and connect to 115 volt or 230 volt power source.**
- 10. Make certain that the power source conforms to the requirements of your equipment.**
- 11. Profan axial fan are designed to mount in vertical and horizontal direction only. Arrows stamped on housing indicate direction of blade rotation and airflow.**
- 12. Capacitor starting fan don't suit to use on welding machine.**
- 13. Product has one year limited warranty.**