

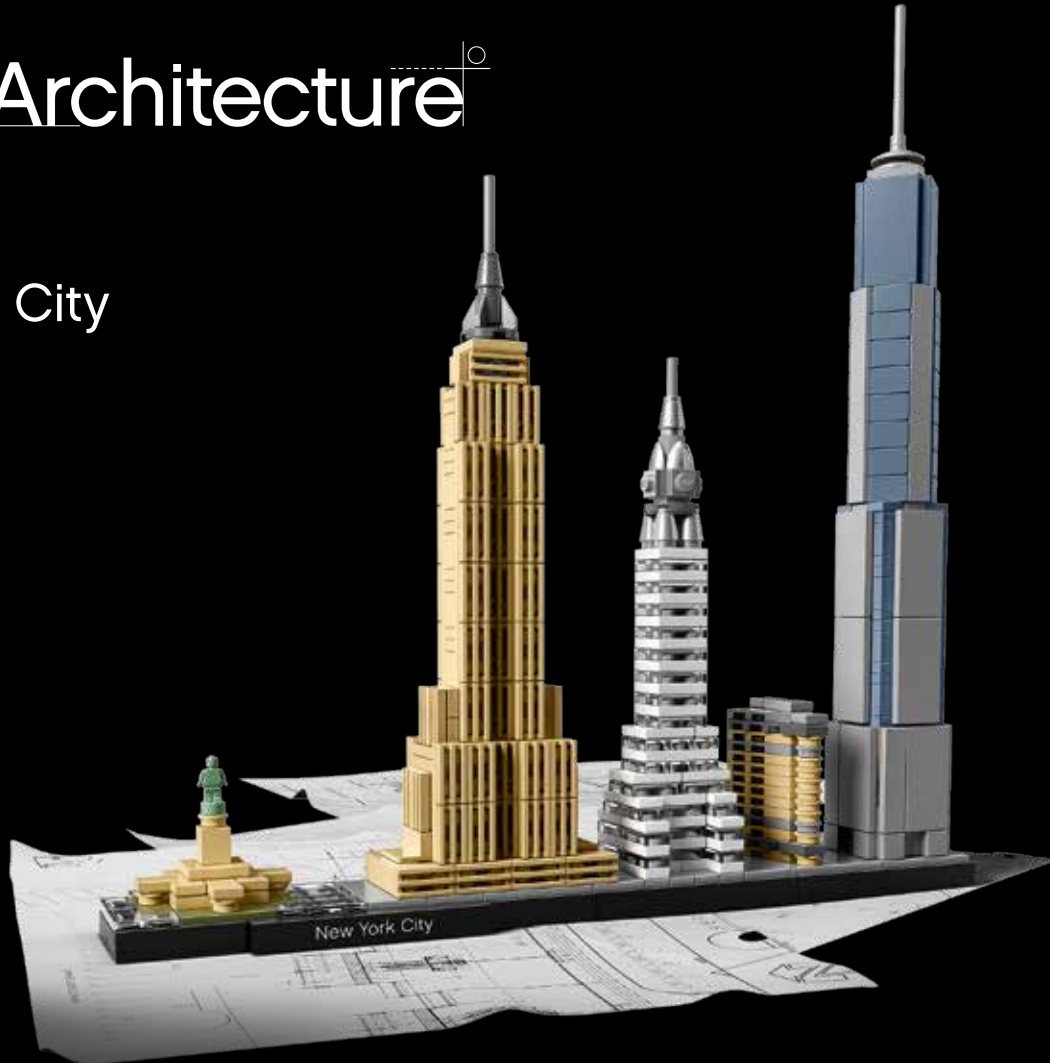

Architecture

21028
New York City
New York, USA



New York City

Home to one of the most iconic skylines in the world, New York City sits at the point where the Hudson River meets the Atlantic Ocean.

The city consists of five boroughs—Brooklyn, Queens, Manhattan, the Bronx and Staten Island—and can trace its roots back to 1624, when Dutch colonists founded a trading post called New Amsterdam. Renamed New York in 1664, it has been the United States' largest city since 1790. Today almost 8.5 million people live in an area of just 305 sq. miles (790 km²), which also makes it the most densely populated city in the country.

The city's architecture mixes traditional structures with modern designs, but the skyline is most famous for its skyscrapers. With more than 550 structures over 330 ft. (100 m) high, only Hong Kong has a greater number of tall buildings.

With three of the world's ten most visited attractions—Times Square, Central Park and Grand Central Station—the city is a popular tourist destination with 56 million visitors in 2014. It is often claimed that New York City is the most photographed city in the world.

[“New York is the
only real city-city.”]

Truman Capote



One World Trade Center

As the main building of the World Trade Center complex, the new One World Trade Center tower stands as both a shining beacon for the downtown business district and a bold addition to the New York skyline.

The building was completed in May 2013, when the final section of the 408 ft. (124 m) spire was installed, bringing the structure's height to a symbolic 1,776 ft. (541 m)—a deliberate reference to the year when the United States Declaration of Independence was signed.

Designed by architect David M. Childs from the New York office of Skidmore, Owings & Merrill, the tower ascends from a cubic base, its edges slanting back to form eight isosceles triangles with a perfect octagon near its middle, culminating in a glass parapet at the top.

The enclosed One World Observatory allows visitors a spectacular view of the surrounding city from 1,250 ft. (381 m) above street level. At night, an intense beam of horizontal light is projected from the spire and is visible over 1,000 ft. (300 m) above the tower.

[“There is something in the New York air that makes sleep useless.”]

Simone de Beauvoir



The Statue of Liberty

Standing on Liberty Island at the entrance to New York Harbor, the Statue of Liberty was a welcoming signal to millions of immigrants and a symbol of freedom and democracy in the United States.

Designed by the French sculptor Frédéric Auguste Bartholdi and given as a gift to the United States from the people of France, the robed female figure represents the Roman goddess Libertas. In one hand she raises a torch, in the other she holds a tablet inscribed with the date of the American Declaration of Independence, July 4, 1776.

The 151 ft. (46 m) tall copper statue was constructed in France and shipped in pieces to the completed pedestal on what was then called Bedloe's Island. The dedication ceremony in October 1886 was presided over by President Grover Cleveland and marked by New York's first ever ticker-tape parade.



The Statue of Liberty

Flatiron Building

Although never the tallest building in New York, or even the first building in the United States with a triangular ground plan, the Flatiron Building remains one of New York's most memorable structures.

Sitting on the intersection where Fifth Avenue and Broadway cross, the Flatiron's famous form was dictated by the shape of the plot of leftover land that lay undeveloped as the city raced northward during the second half of the 19th century. In 1901 the architect Daniel H. Burnham was hired to design a new showcase headquarters on the site for Chicago-based contractors The Fuller Company.

Burnham's radical design created a great deal of debate as the massive structure neared completion in 1902. Many New Yorkers believed that the unstable building would fall over at the first gust of wind. The Flatiron withstood both the criticism and the strong winds and, over a century later, stands tall as a groundbreaking engineering marvel.

Valued today at \$190 million, the Flatiron Building continues to function as a popular retail and office space. In 2009, Sorgente Group of America acquired the majority of the Flatiron Building.



Chrysler Building™

At 1,046 ft. (319 m) the Chrysler Building was the world's tallest building for 11 months before being surpassed by the Empire State Building in 1931. It remains the tallest steel-supported brick building in the world and is seen as an outstanding example of classic Art Deco architecture.

It was designed by New York architect William Van Alen for Walter P. Chrysler, chairman of the Chrysler Corporation, and construction commenced in September 1928. Almost 400,000 rivets were used in the creation of the steel skeleton and over 3.8 million bricks were manually laid as the building took shape.

As the building would be the headquarters for an automobile company, many of the architectural details including the gargoyles were modeled after Chrysler automobile parts. The iconic stainless-steel crown is composed of seven radiating arches ending in a 125 ft. (38 m) long spire.

Declared a US National Historic Landmark in 1976, the Chrysler Building is consistently rated one of the finest buildings in New York by architects and scholars. Since the observation deck on the 71st floor officially closed in 1945, visitors today can still view the spectacular Art Deco lobby.

[“The Chrysler Building...
was one of the
most accomplished
essays in the style.”]

John Julius Norwich



Chrysler Building

Empire State Building

Located in Midtown Manhattan on Fifth Avenue between West 33rd and West 34th streets, the 1,454 ft. (443 m) tall skyscraper was the world's tallest building when it was completed in April 1931. It remained so for nearly 40 years and is still the fourth tallest skyscraper in the United States and the 25th tallest in the world.

Named after the nickname for the State of New York, the Empire State, the distinctive Art Deco-style structure was designed by Brooklyn-born architect William F. Lamb. Construction began in early 1930 and was completed only 410 days later—12 days ahead of schedule. President Herbert Hoover officially opened the 102-story building on May 1, 1931 when he turned on the building's lights directly from Washington.

Over 3.5 million tourists visit the building's 86th floor observation deck every year to experience a unique panoramic view of New York City. Widely regarded as

an American cultural icon, the Empire State Building was hailed as one of the Seven Wonders of the Modern World by the American Society of Civil Engineers in 1994.

[“From the ruins, lonely
and inexplicable as
the sphinx, rose the
Empire State Building”]

F. Scott Fitzgerald



Empire State Building

["... it's probably the only city which
in reality looks better than on the
postcards, New York."]

Milos Forman



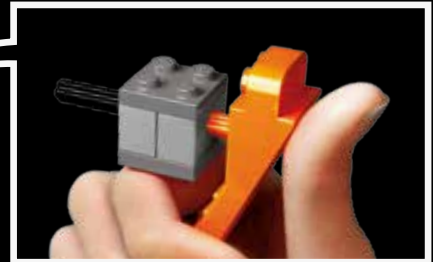
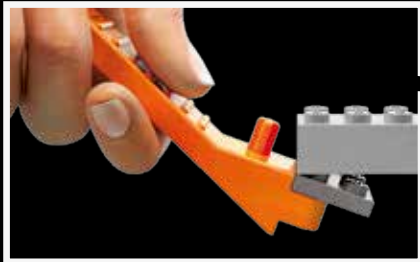

LEGO.com/brickseparator

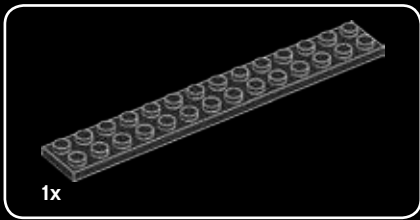

1

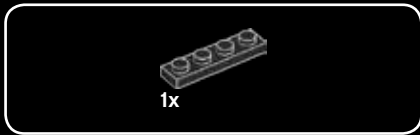
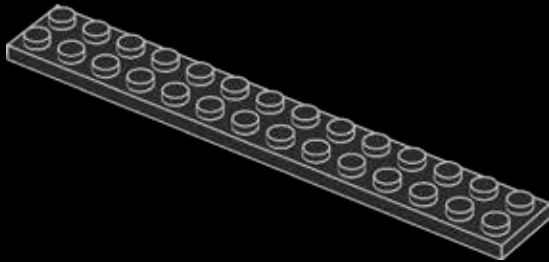

2

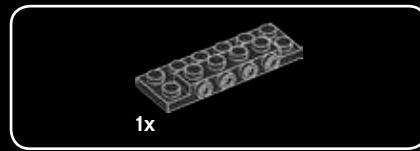
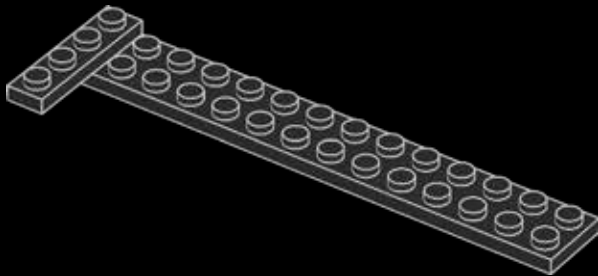

3

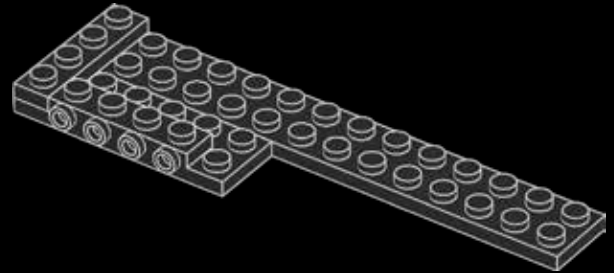

4

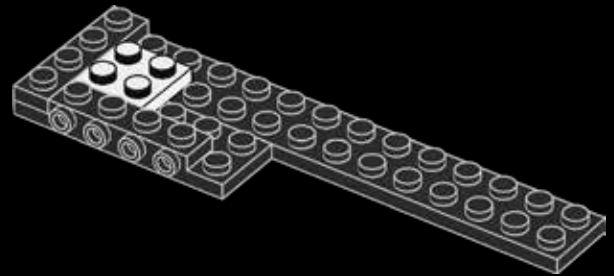

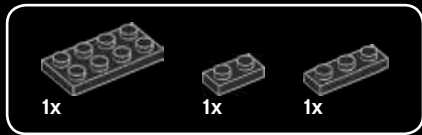

5

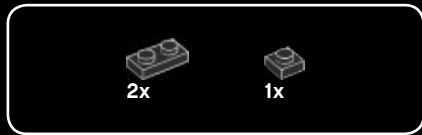
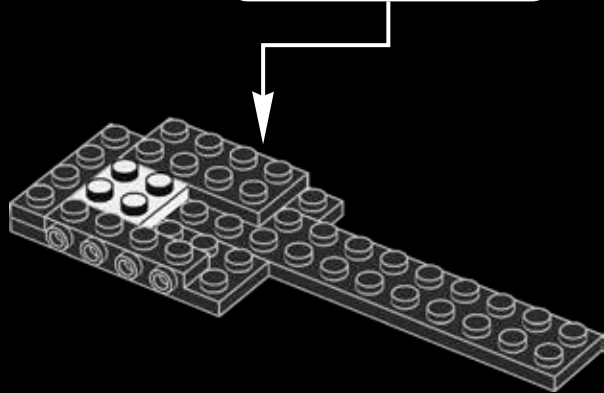
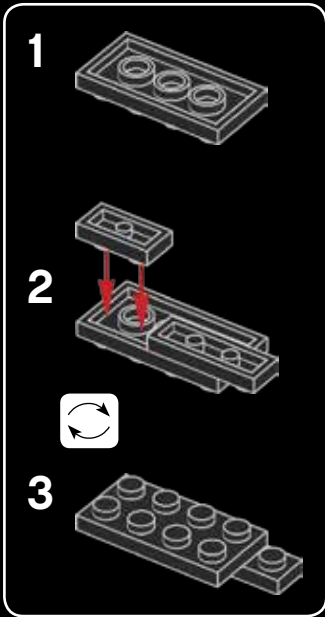

6

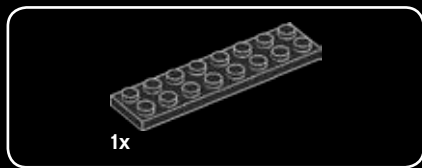
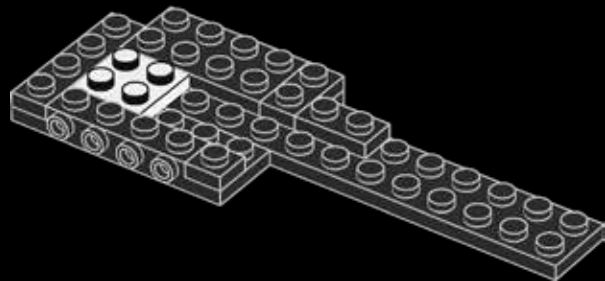

7

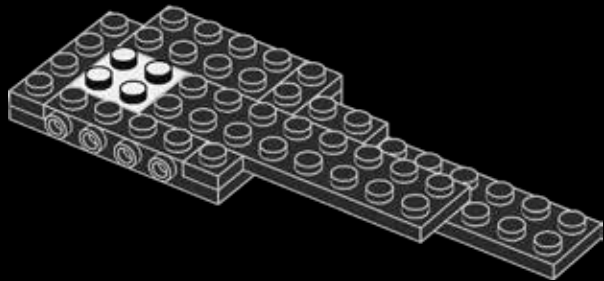



8

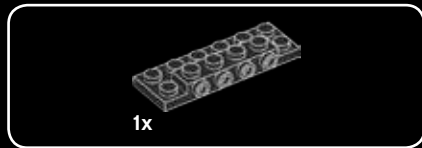
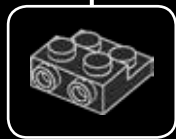
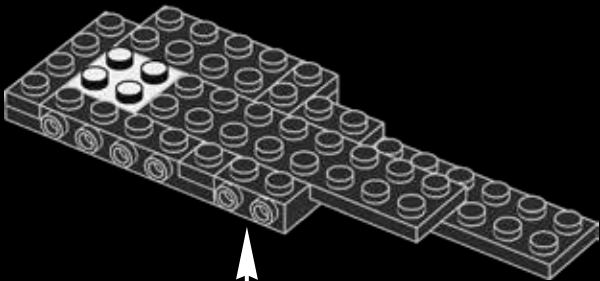

9

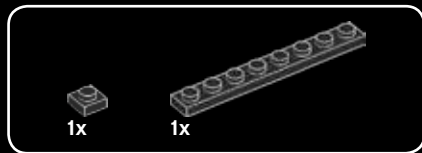
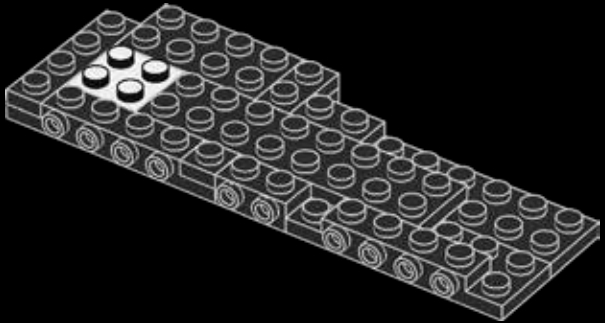

10

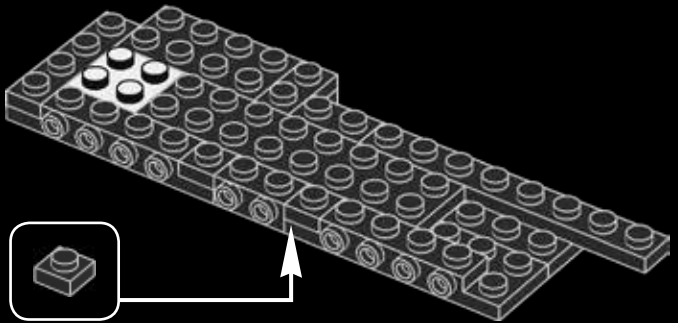

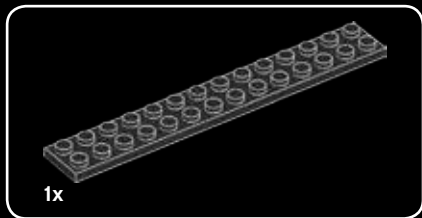

11

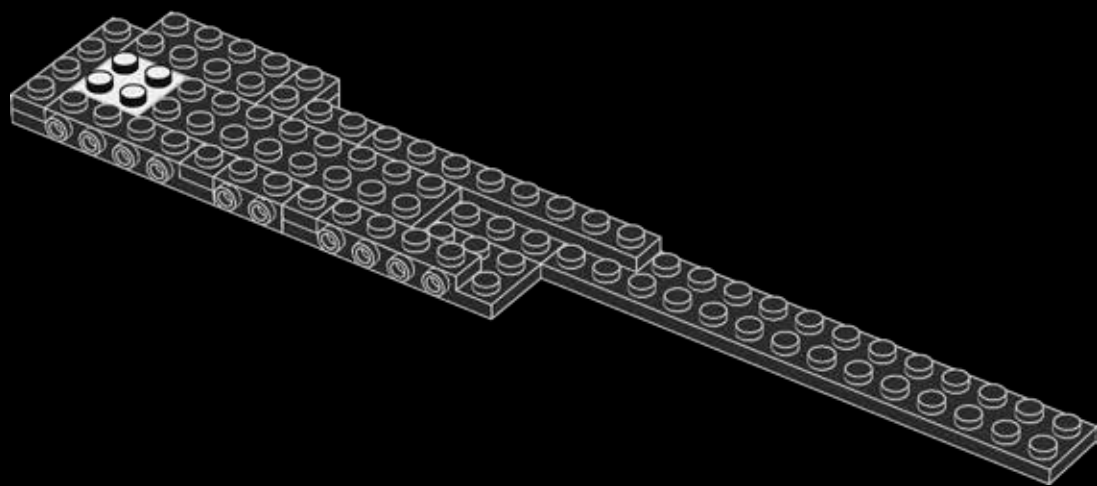

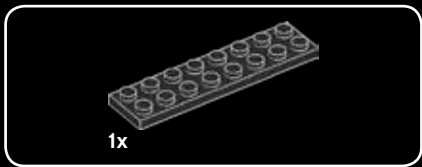

12

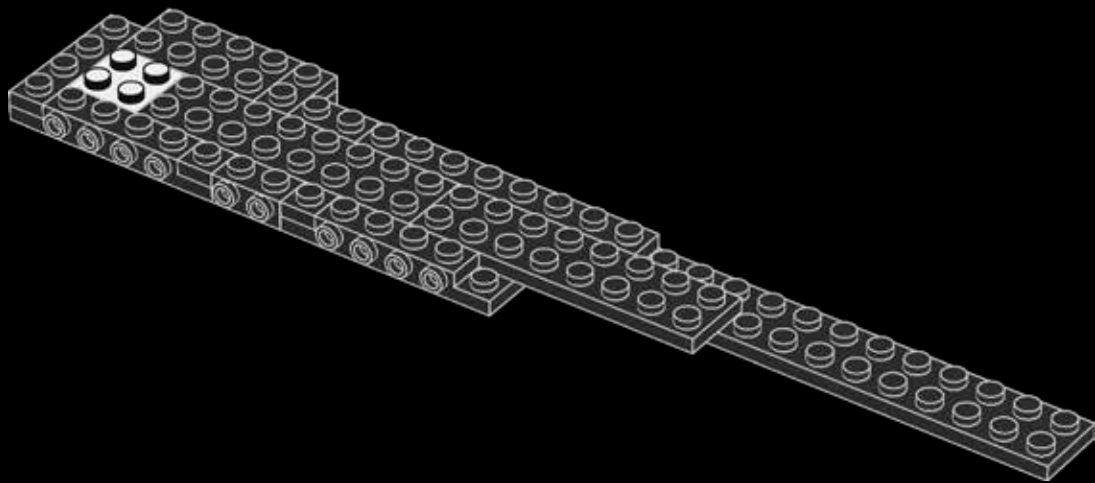



13

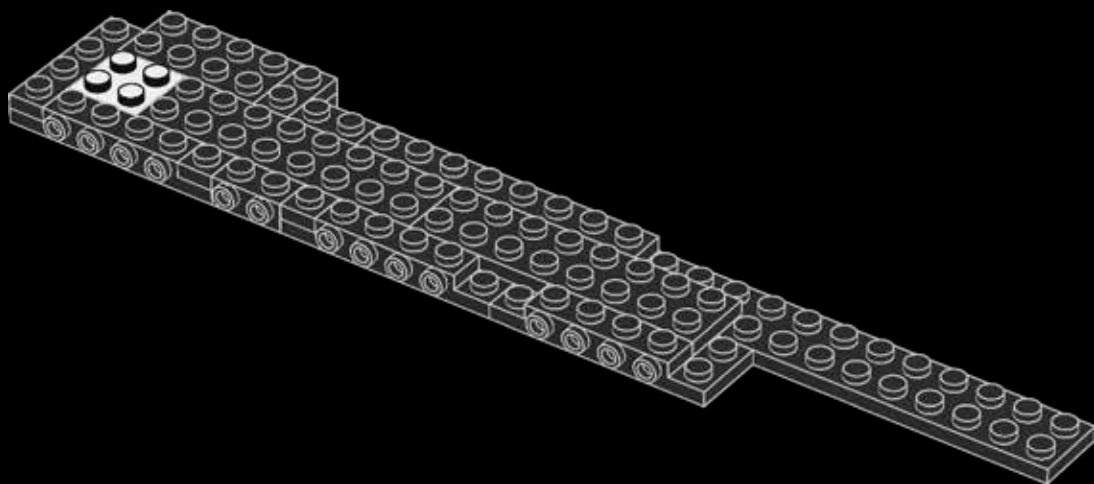

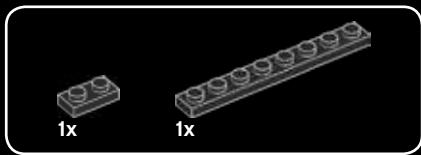

14

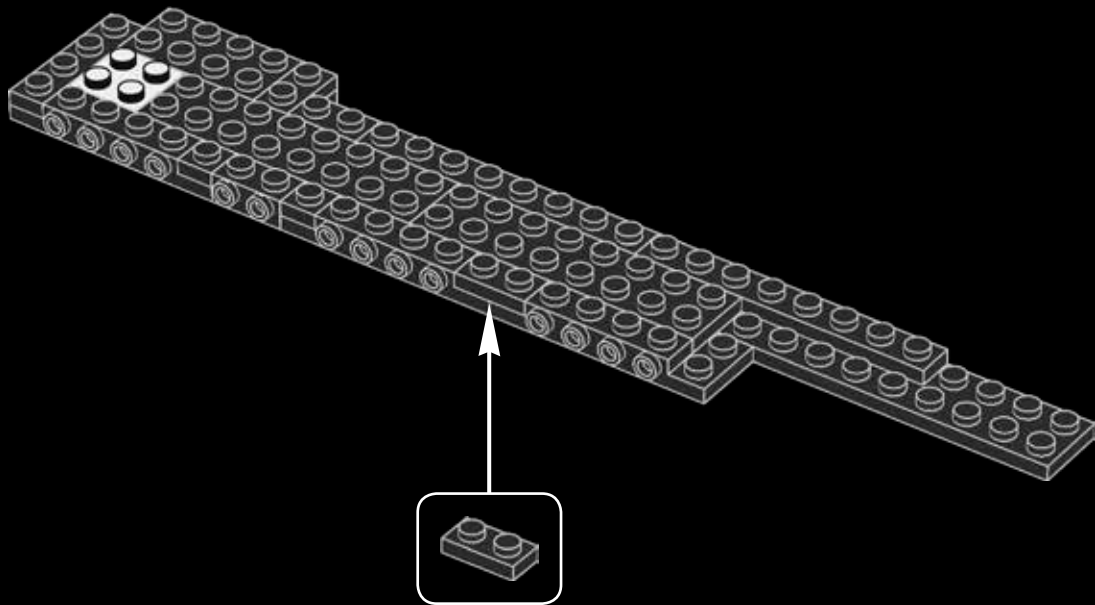

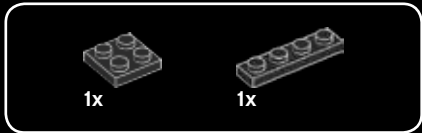

15

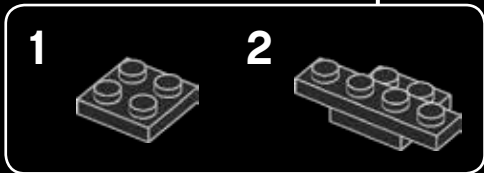
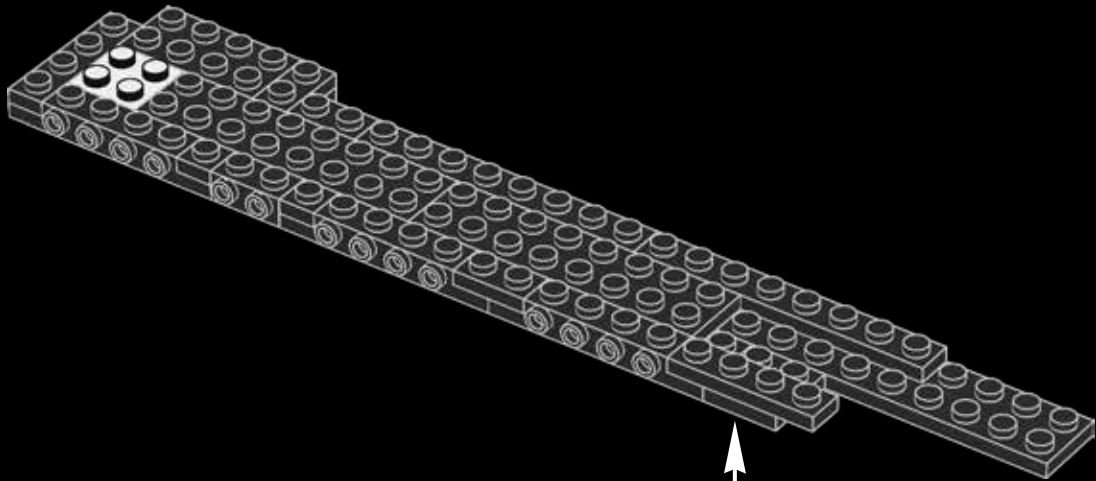

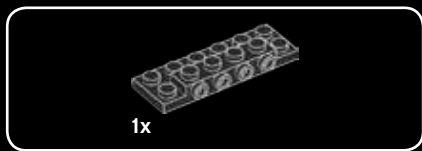

16

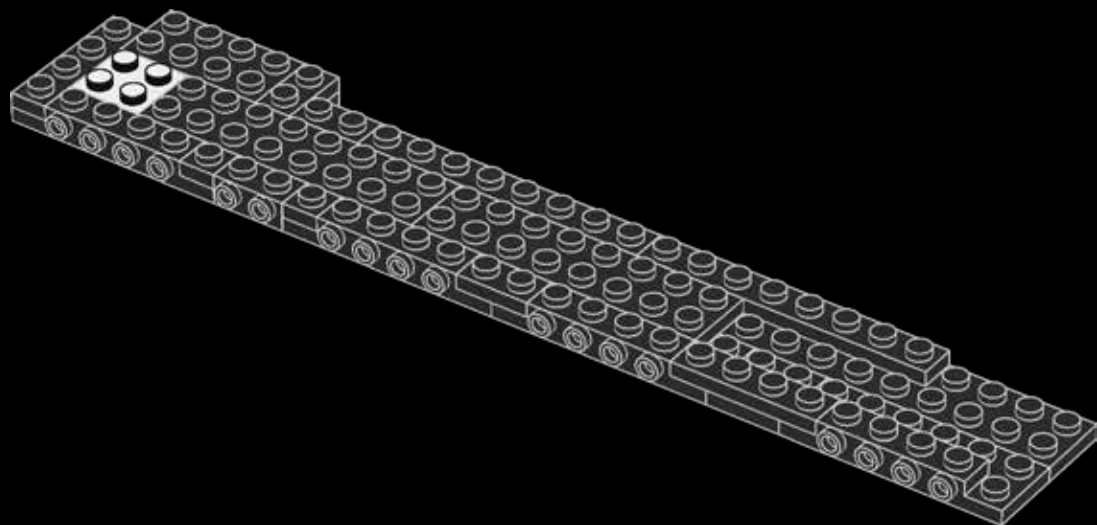

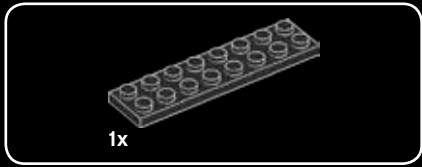

17

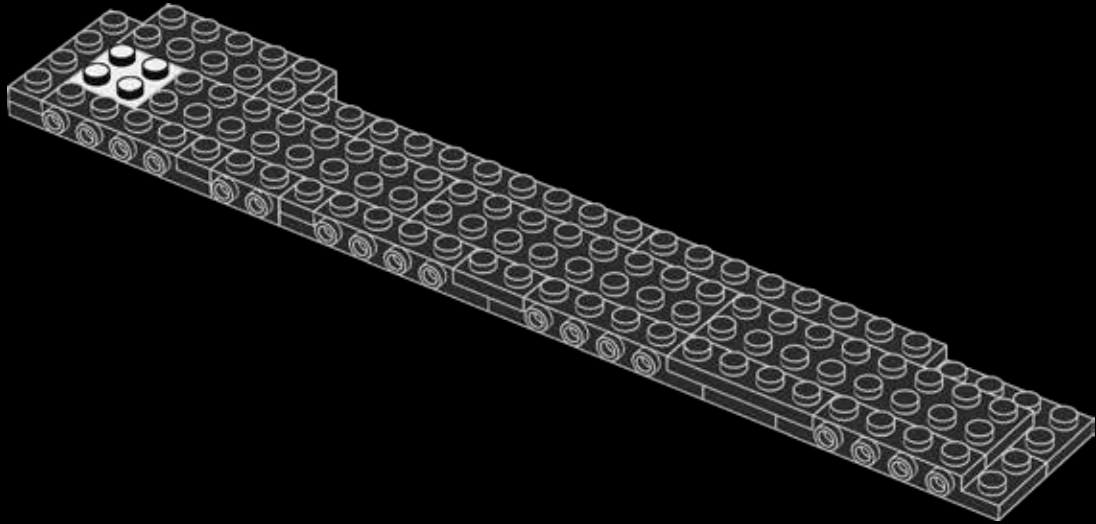

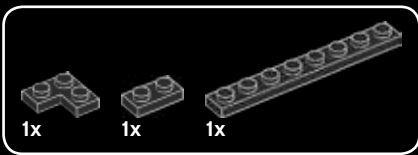

18

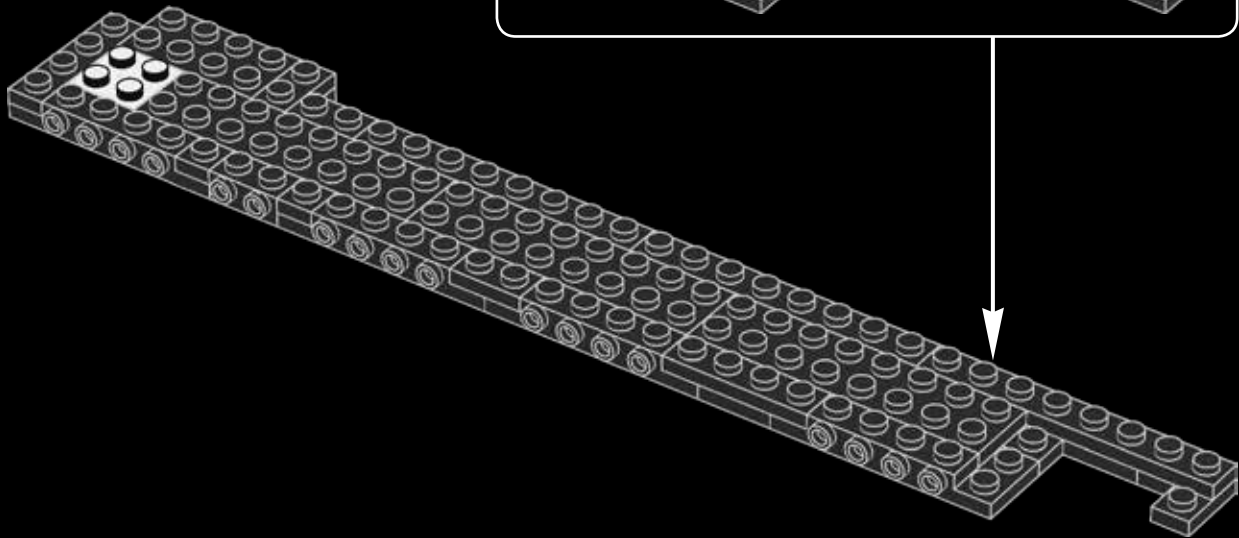
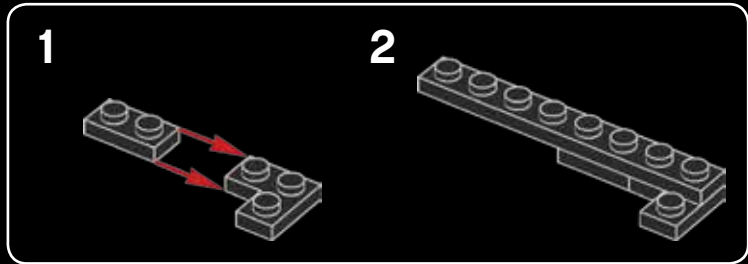



1x

19

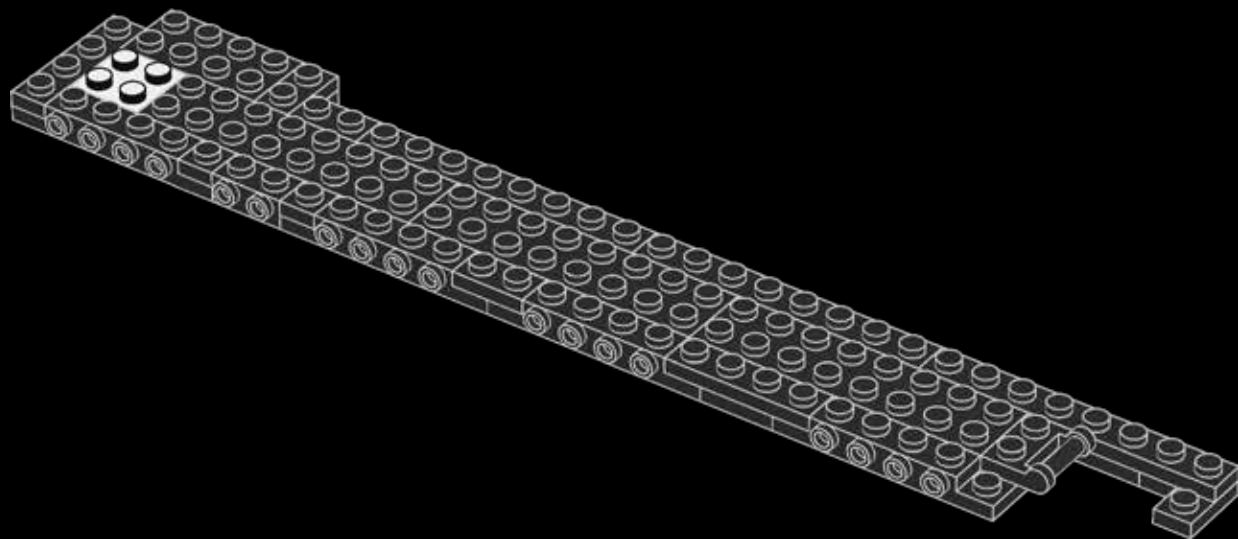



20

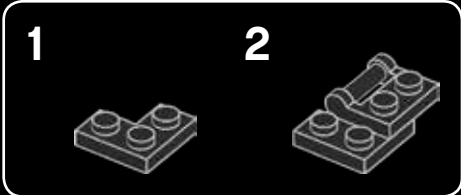
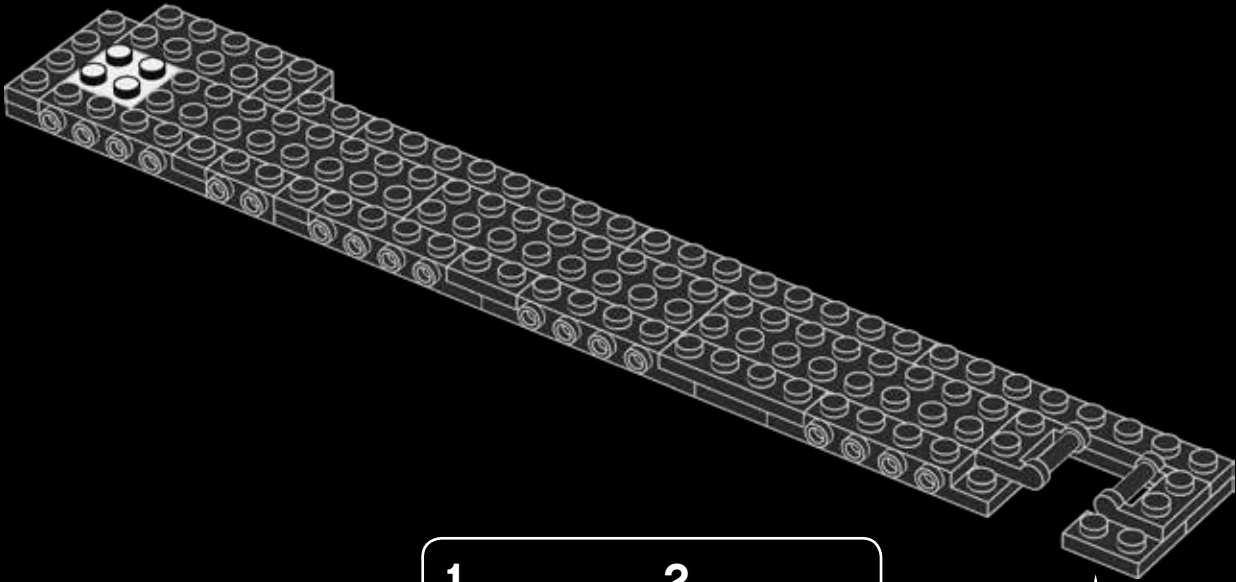



21

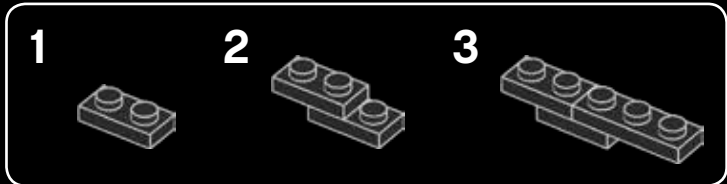
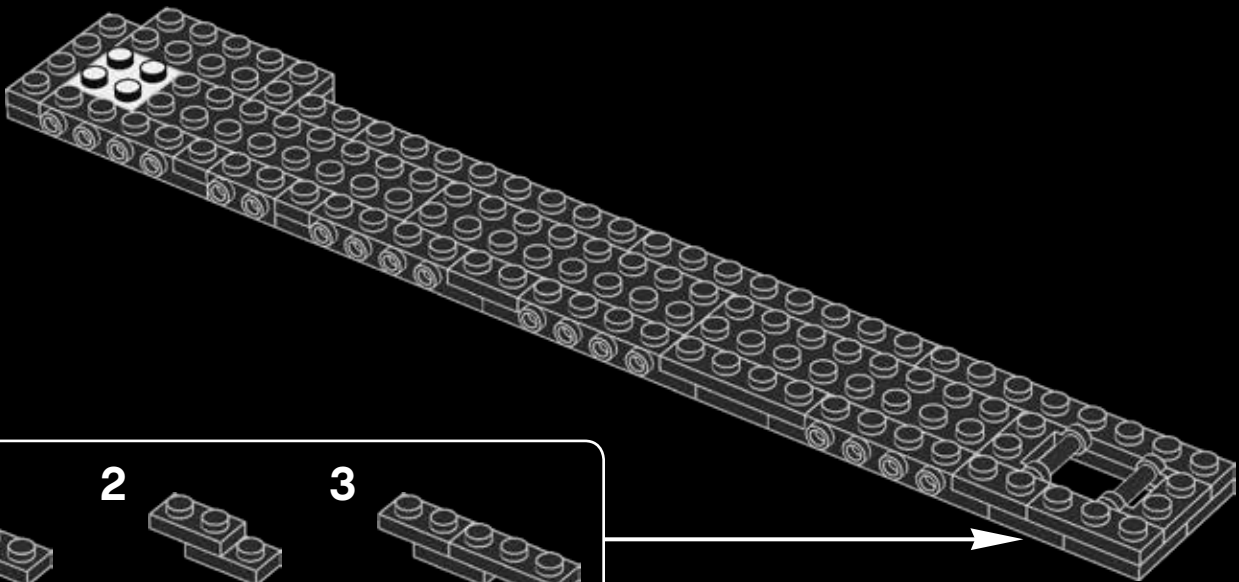

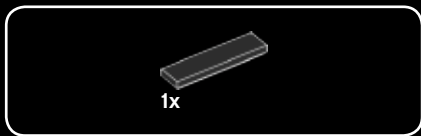

22

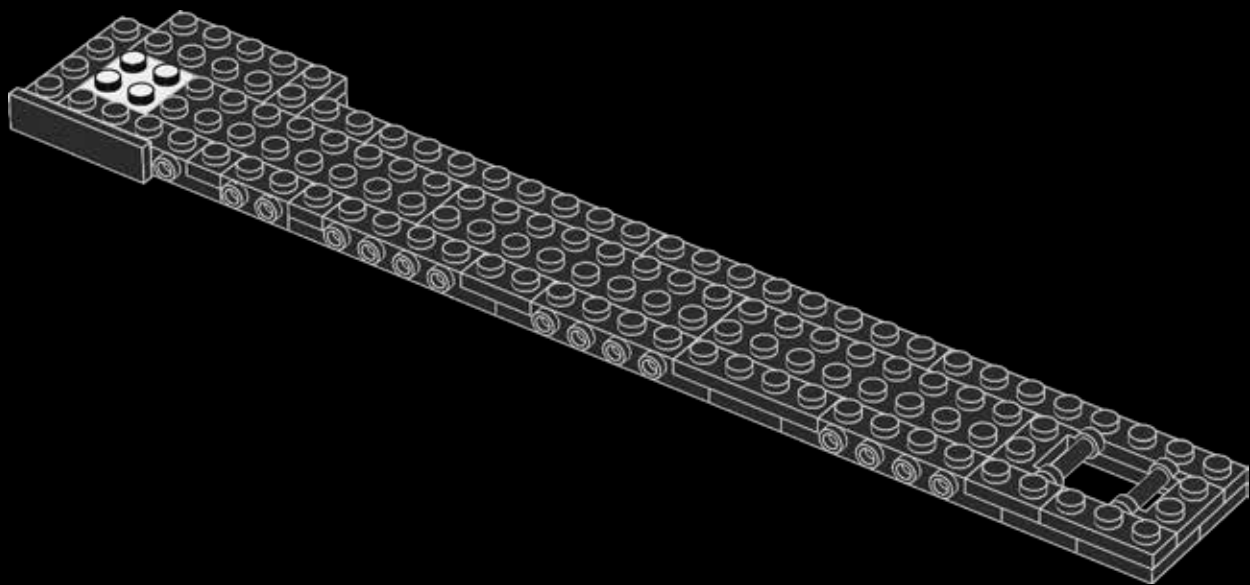

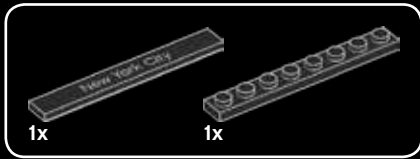

23

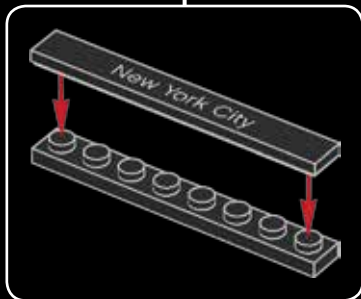
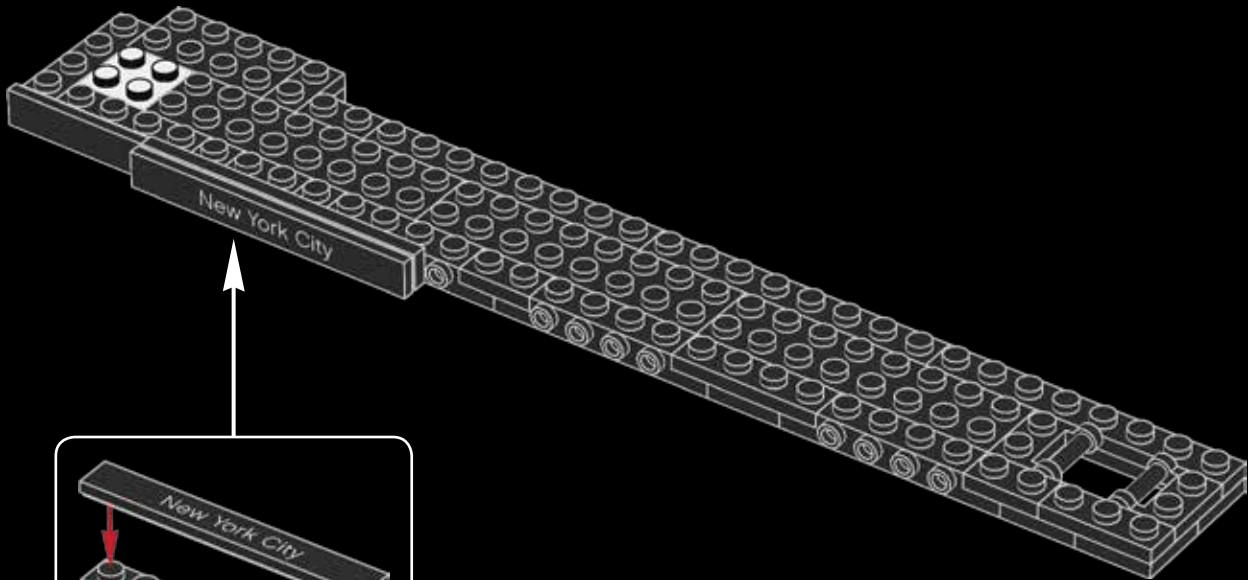

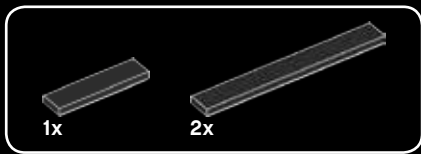

24

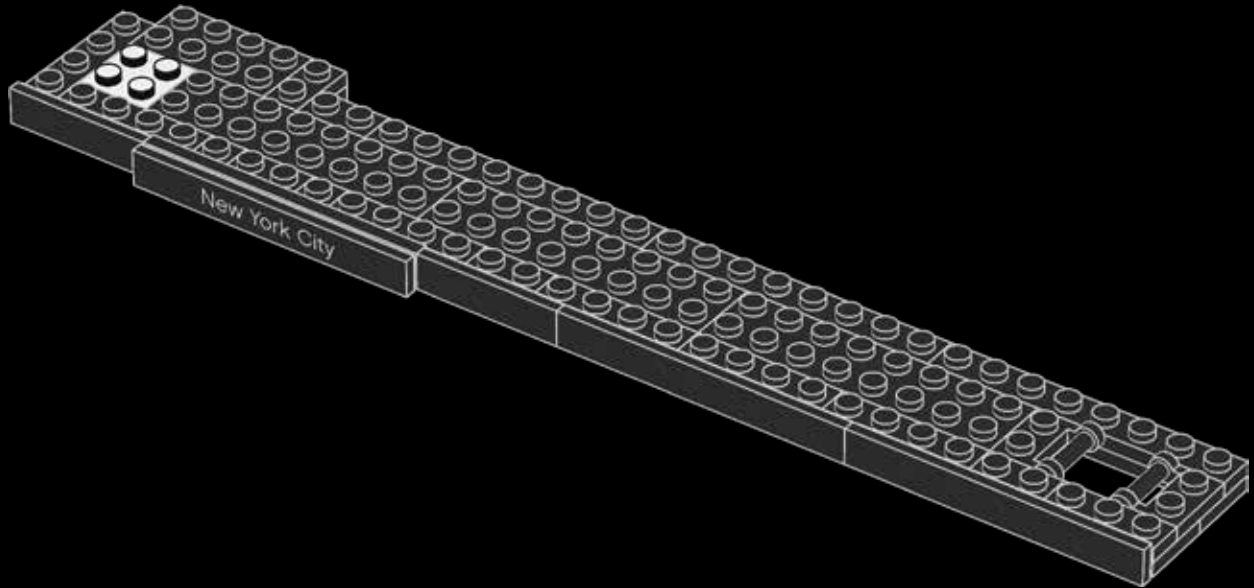



2x

25

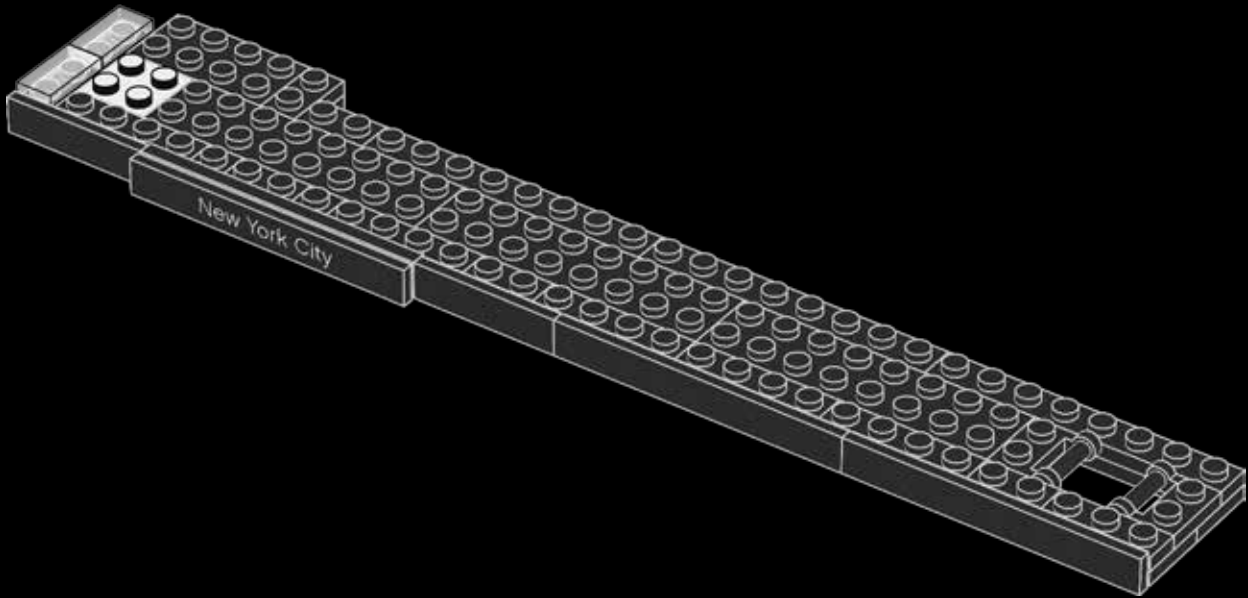

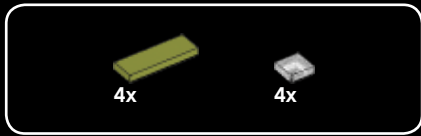

26

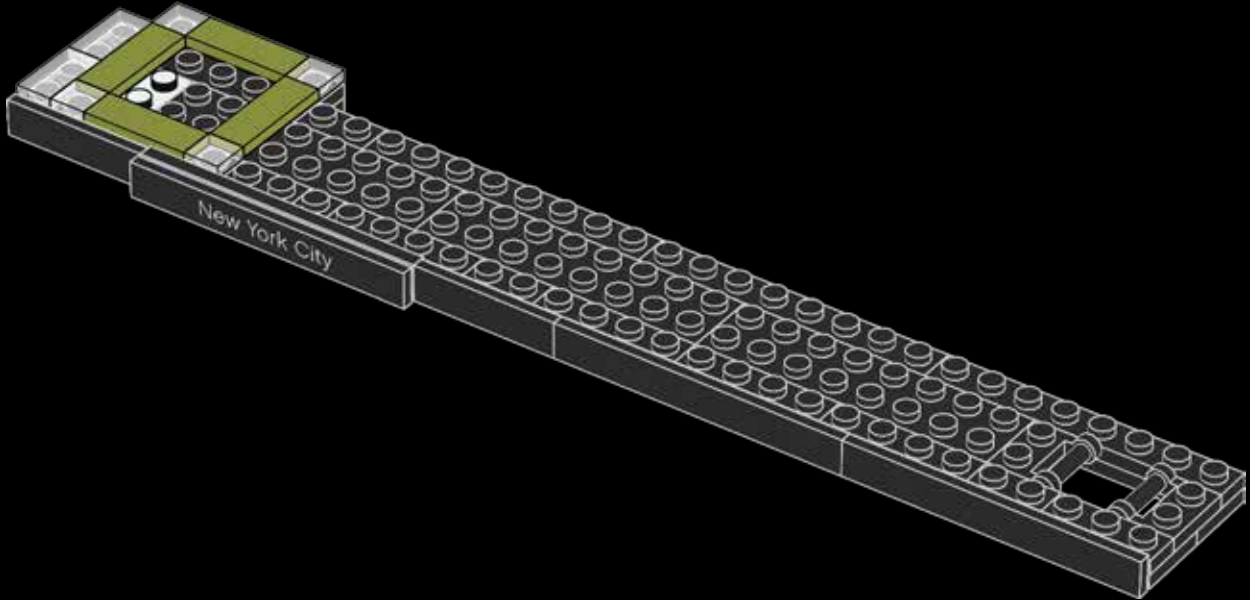



4x

27

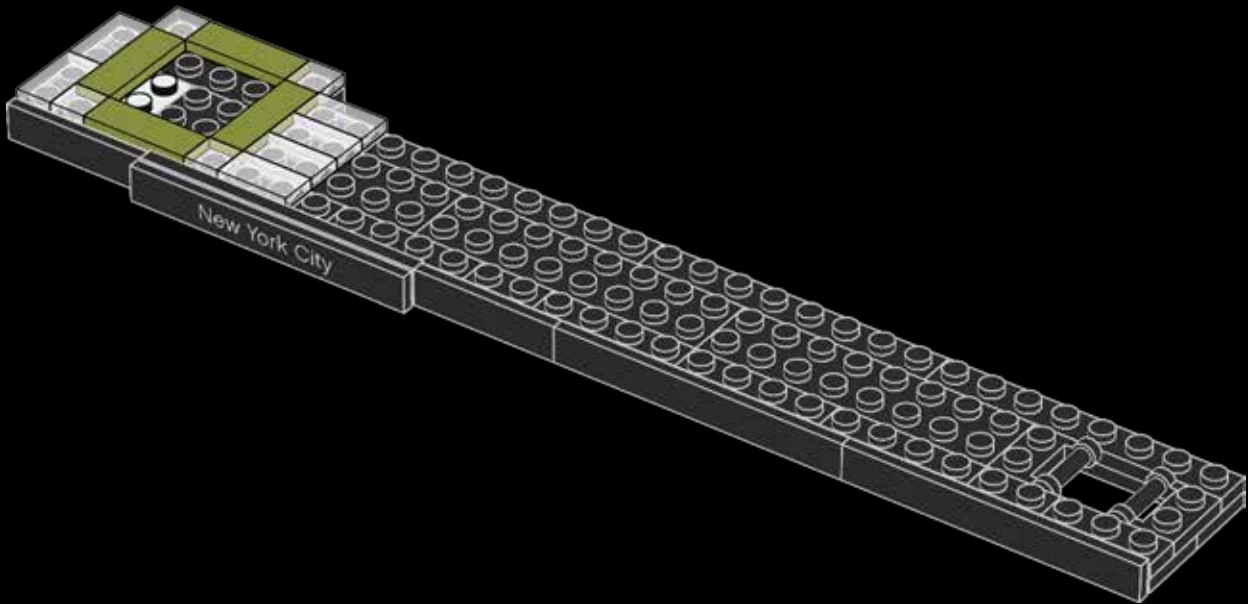

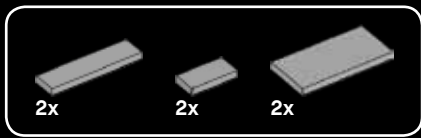

28

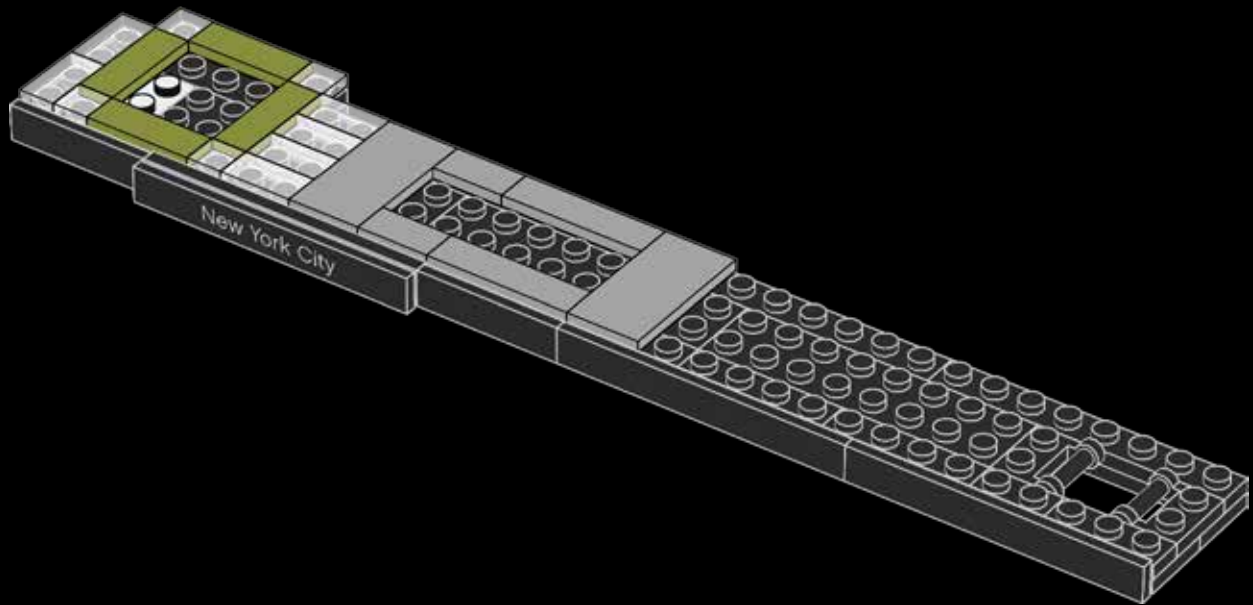



29

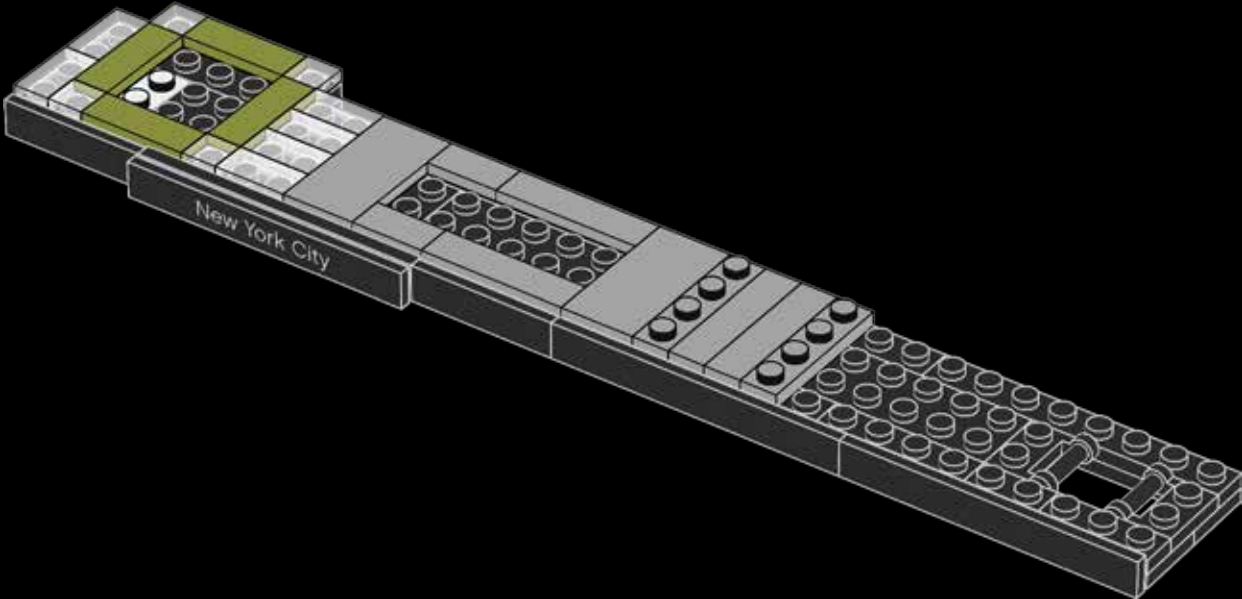

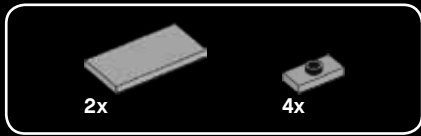

30

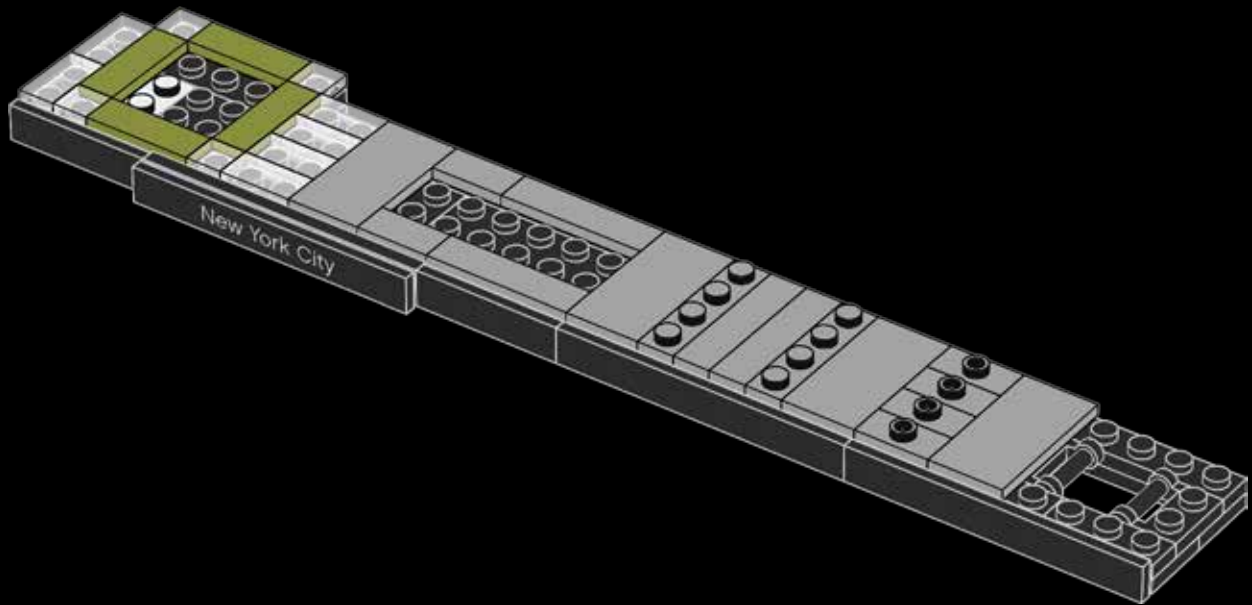



2x



2x

31

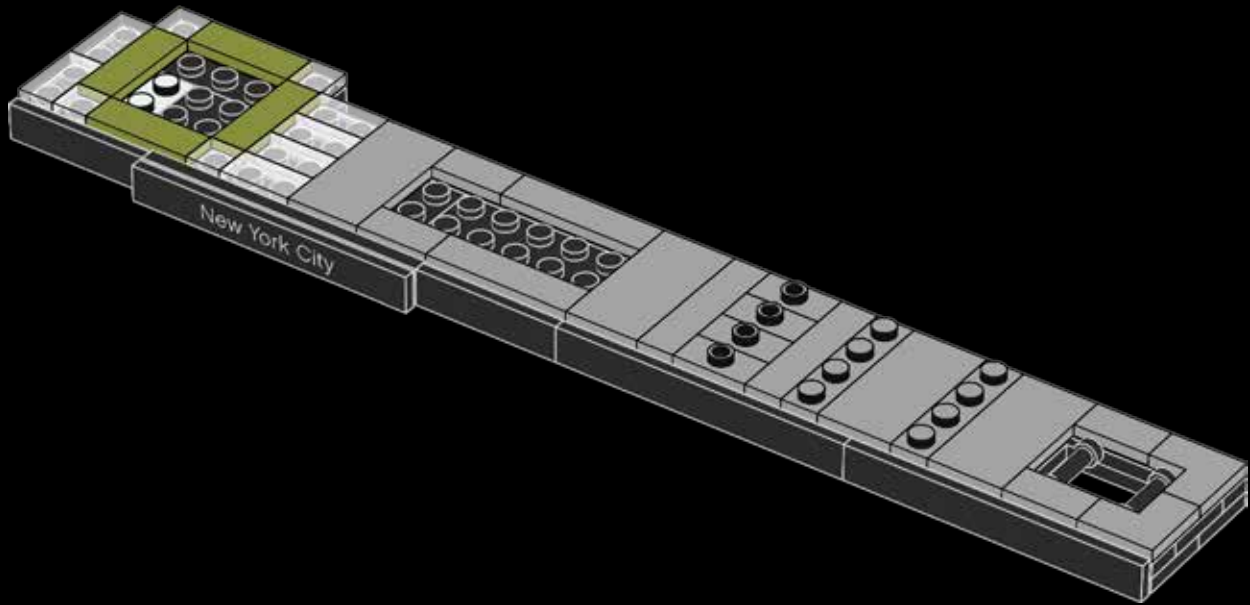

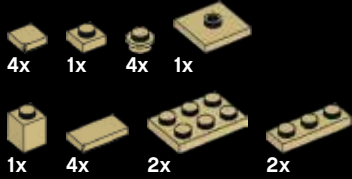

32

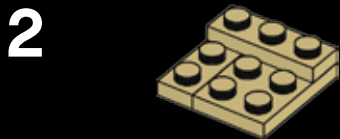
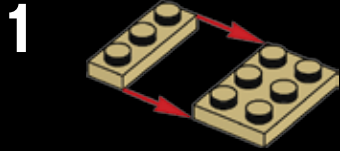

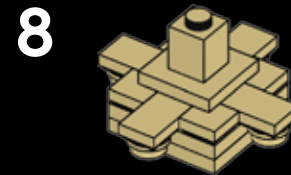
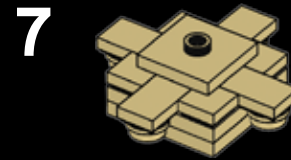
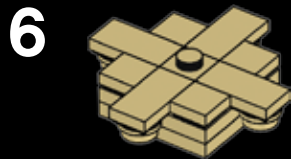
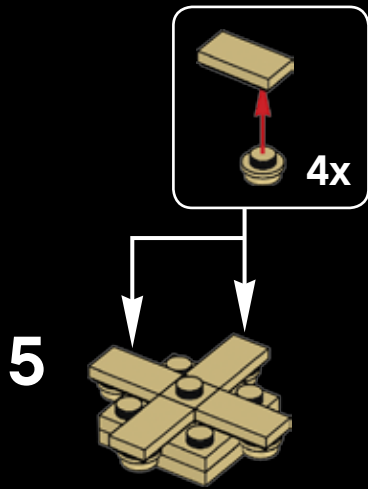

Maintained by the National Park Service since 1933, the Statue of Liberty is visited by around 4 million people every year.



© Victor Maschek

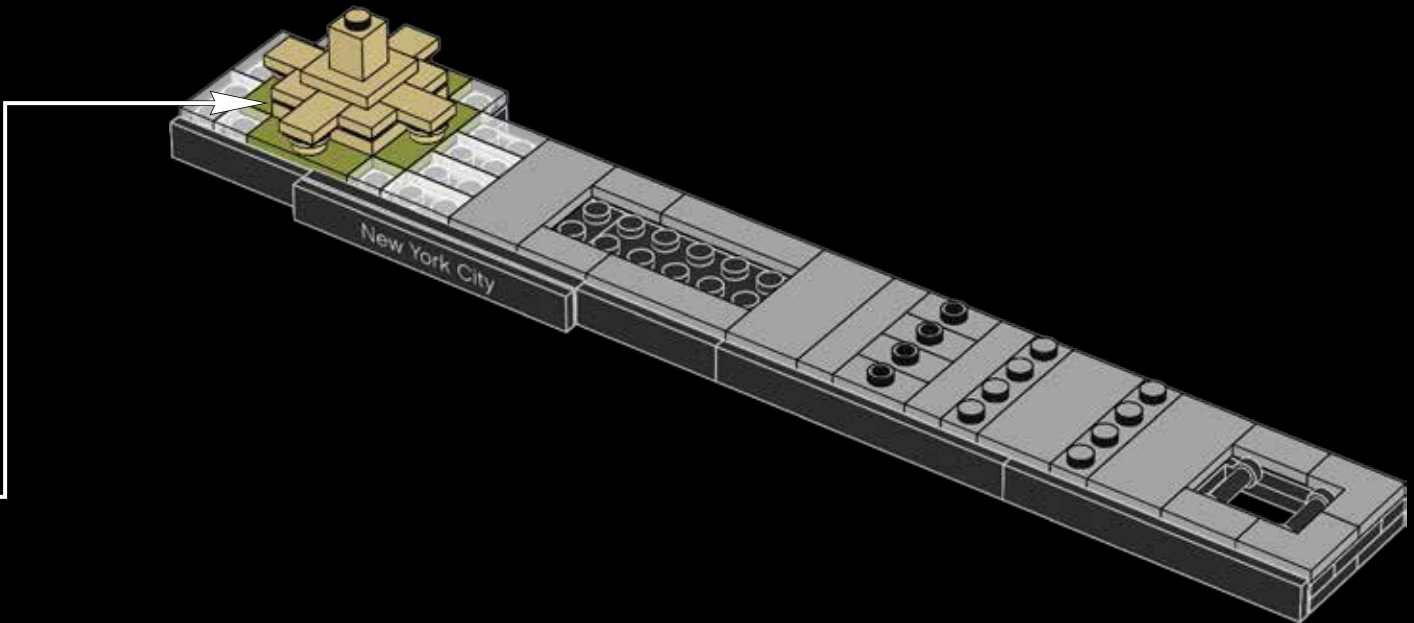



1x



1x

33

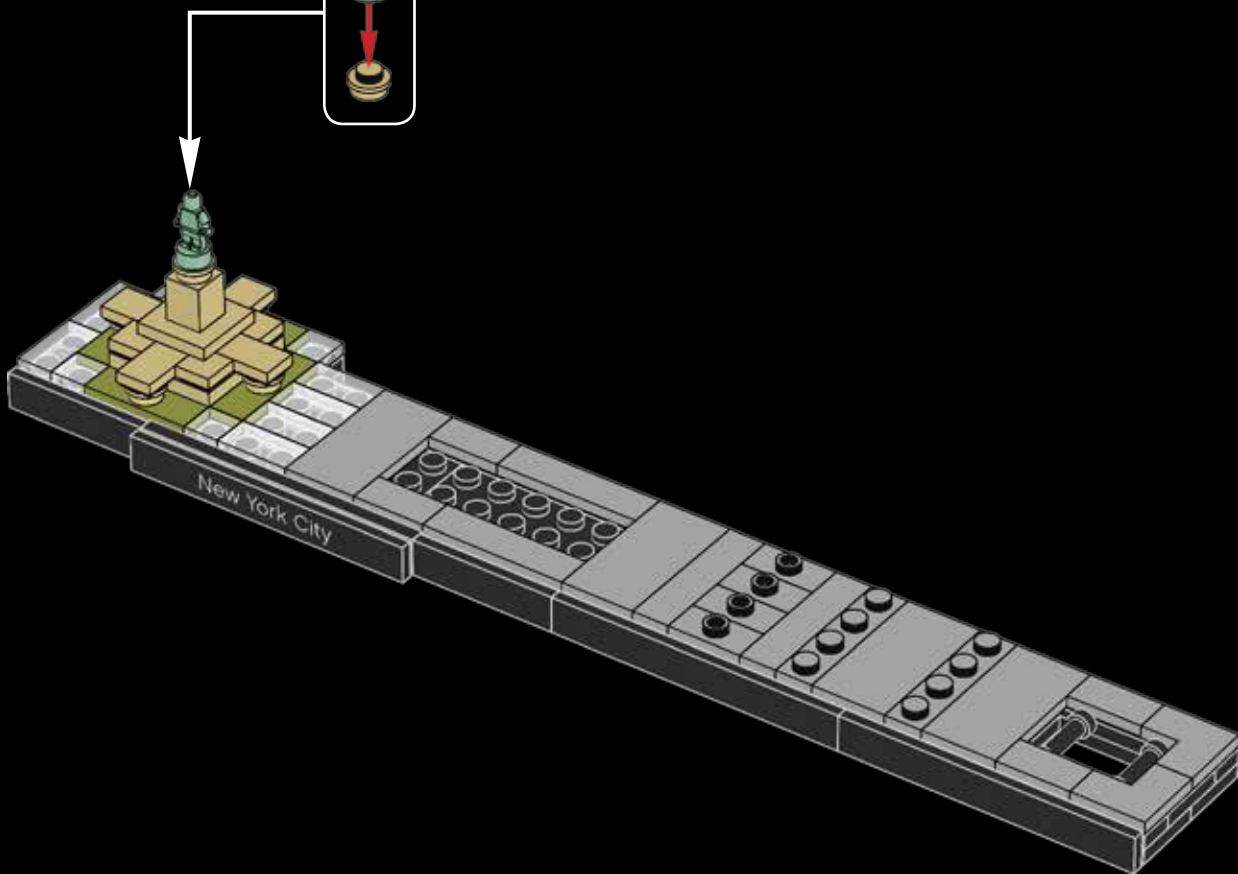
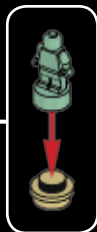

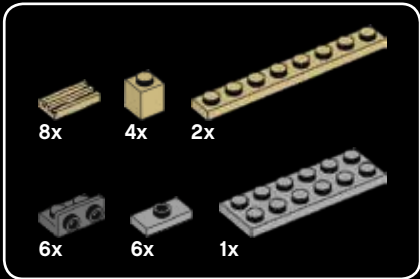

34

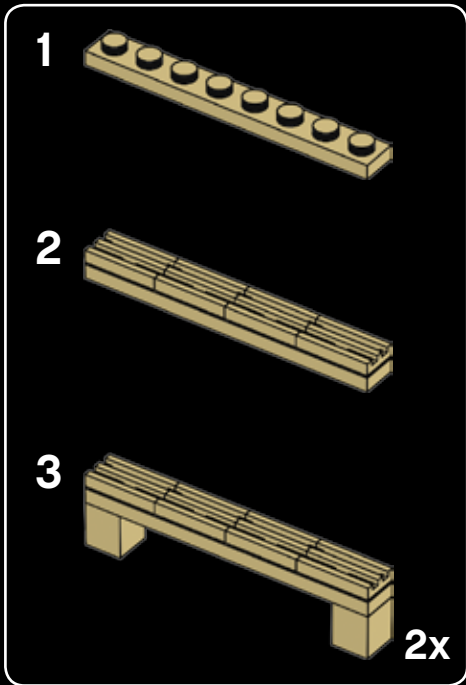

1

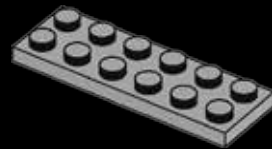

2

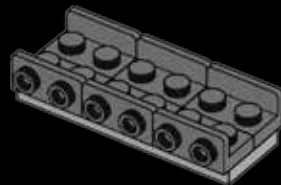

3



4



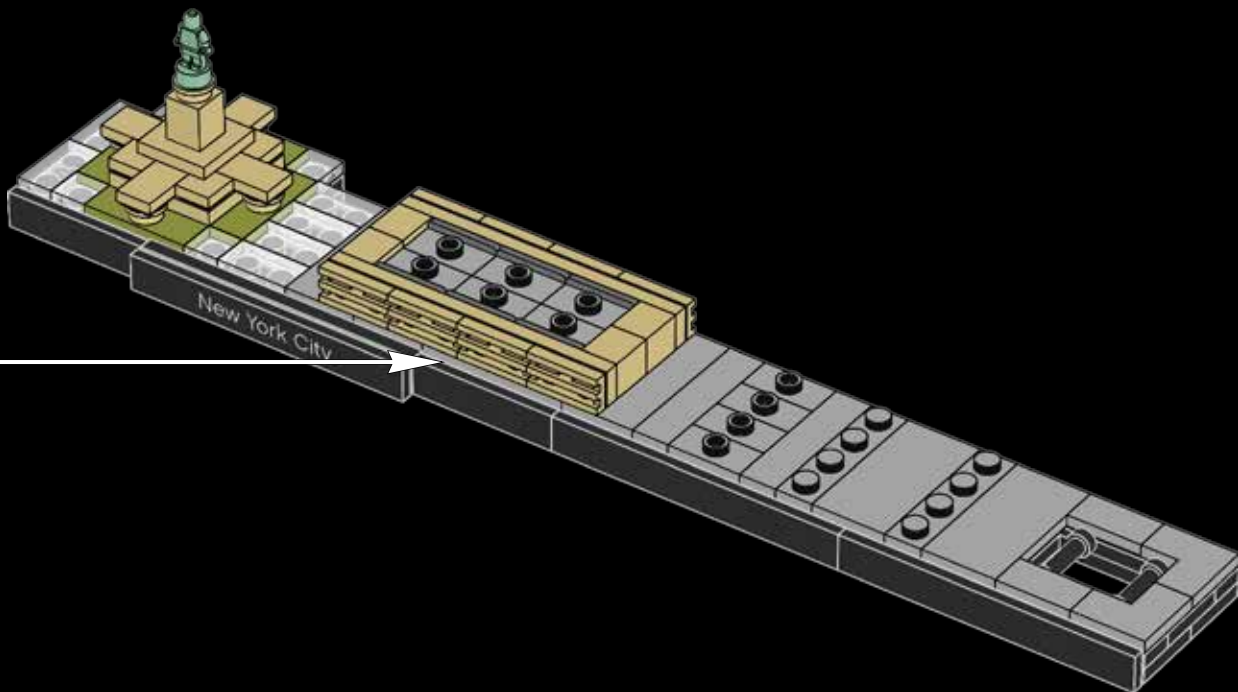



1

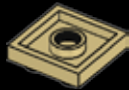

2

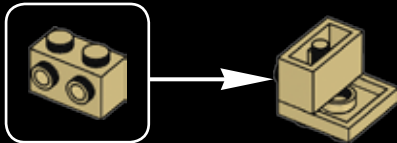

3

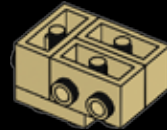

4

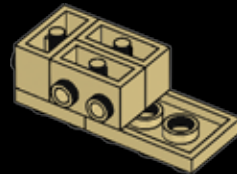



2x

5

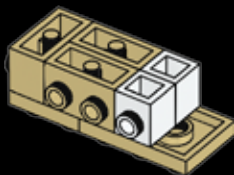

1x

6

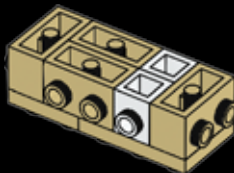

1x



1x

7

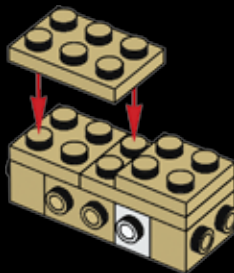

1x

8

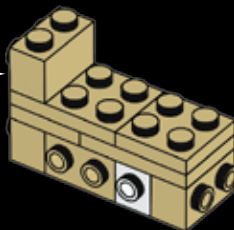



9

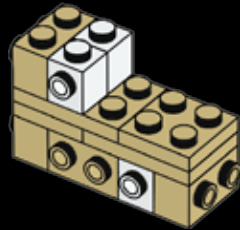

10

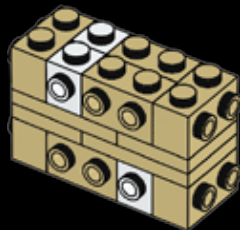

11

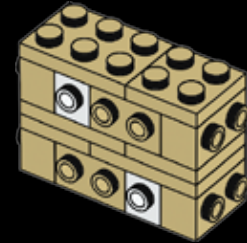

12

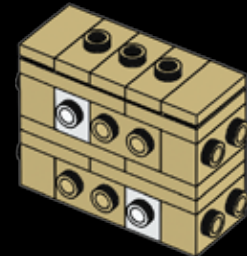



13

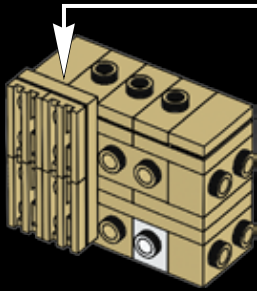
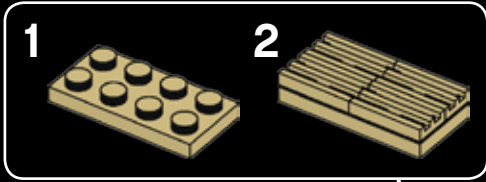

14

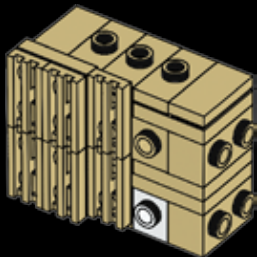

15

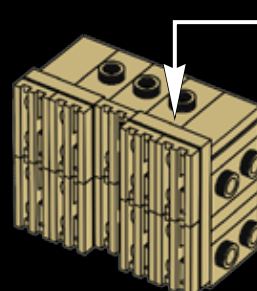
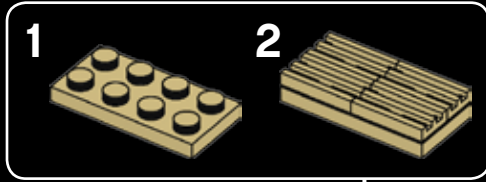

16

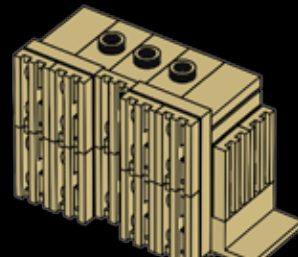



17

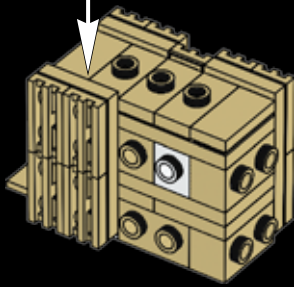
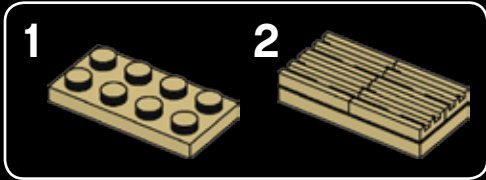

18

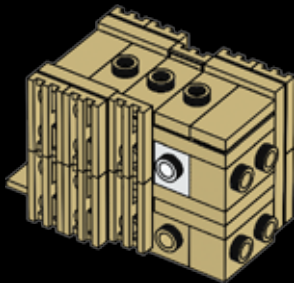

19

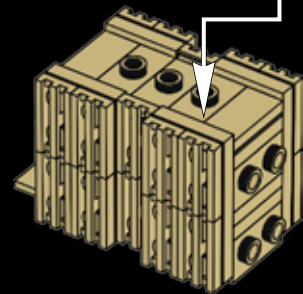
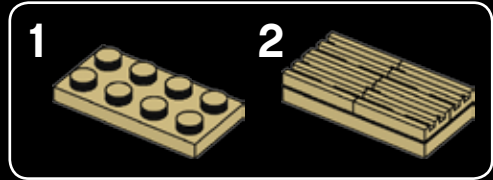

20

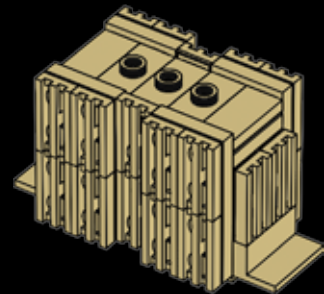



1x

21

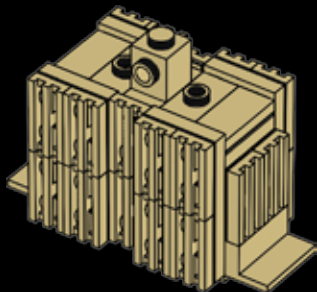

6x

22

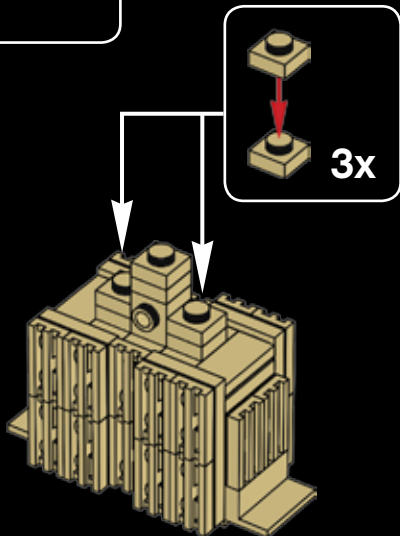

2x

23

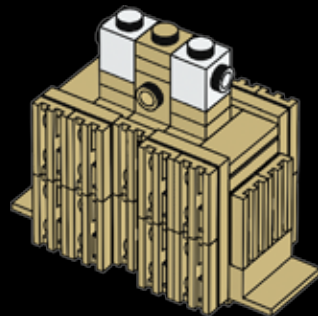

3x



1x

24

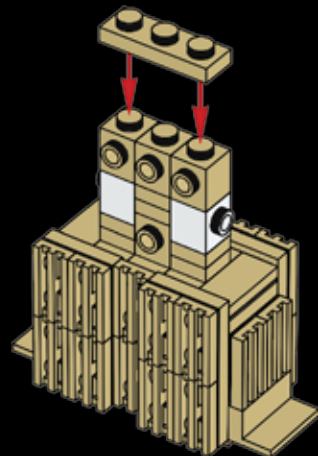

35

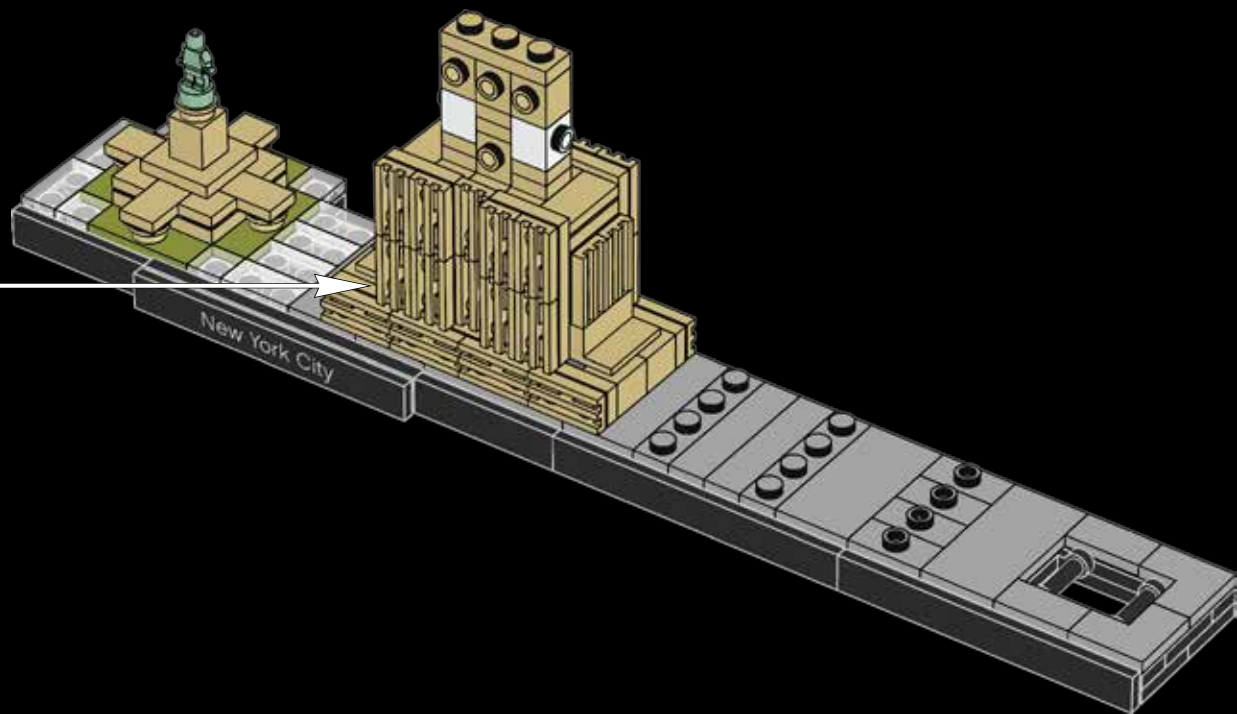



36

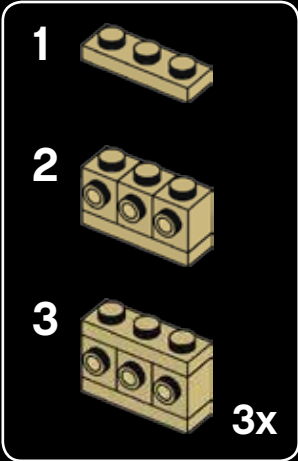

1



2

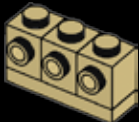

3



4



5



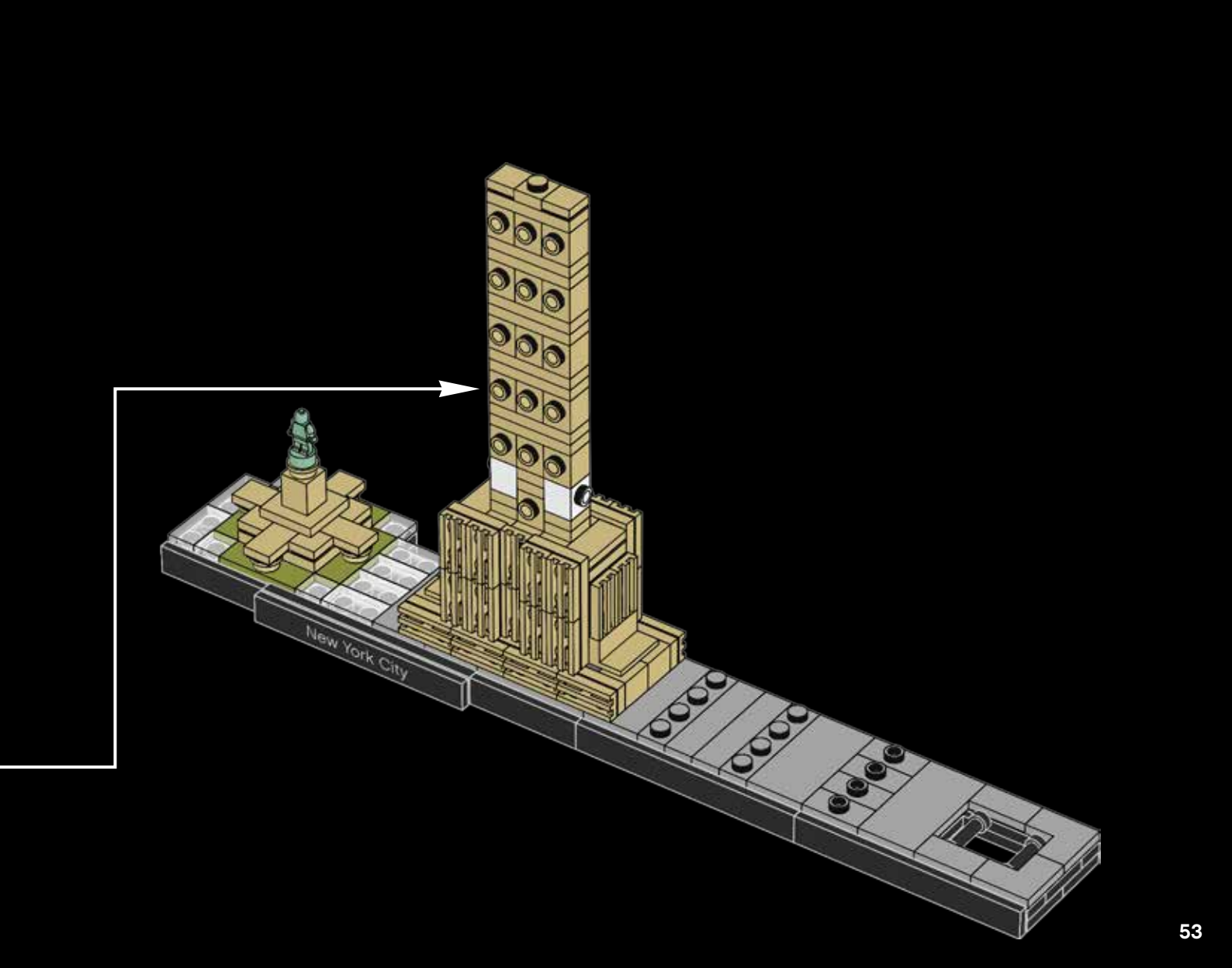

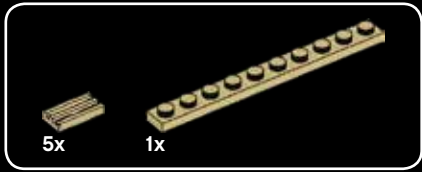

37

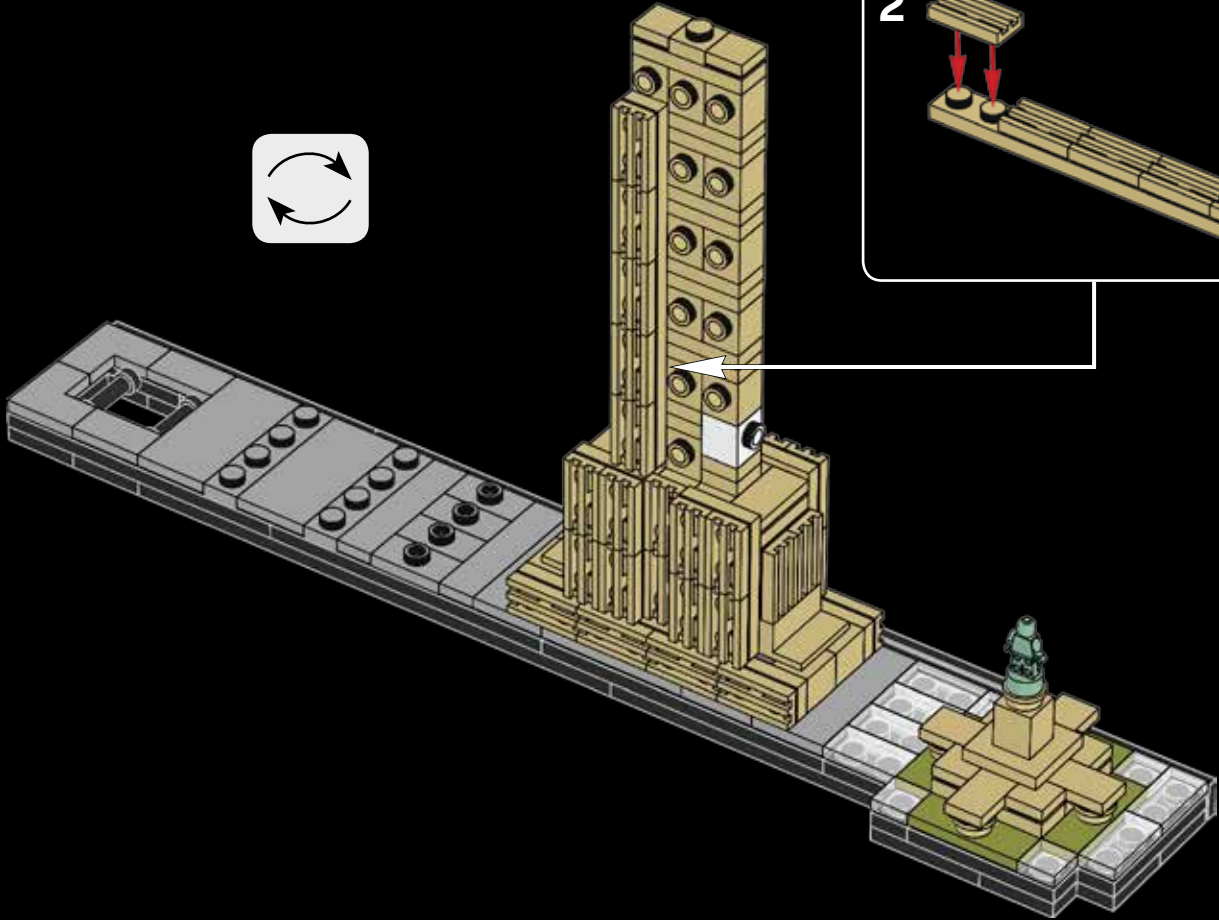
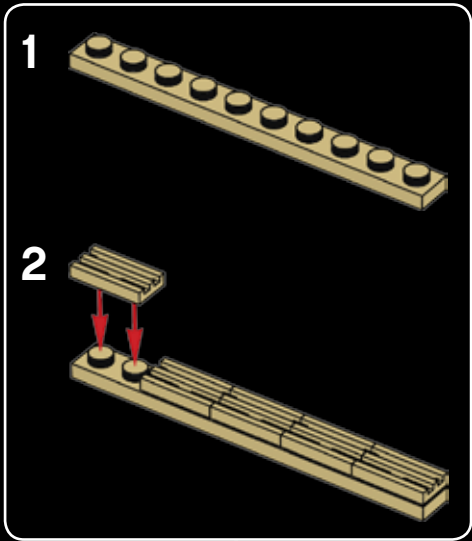



38

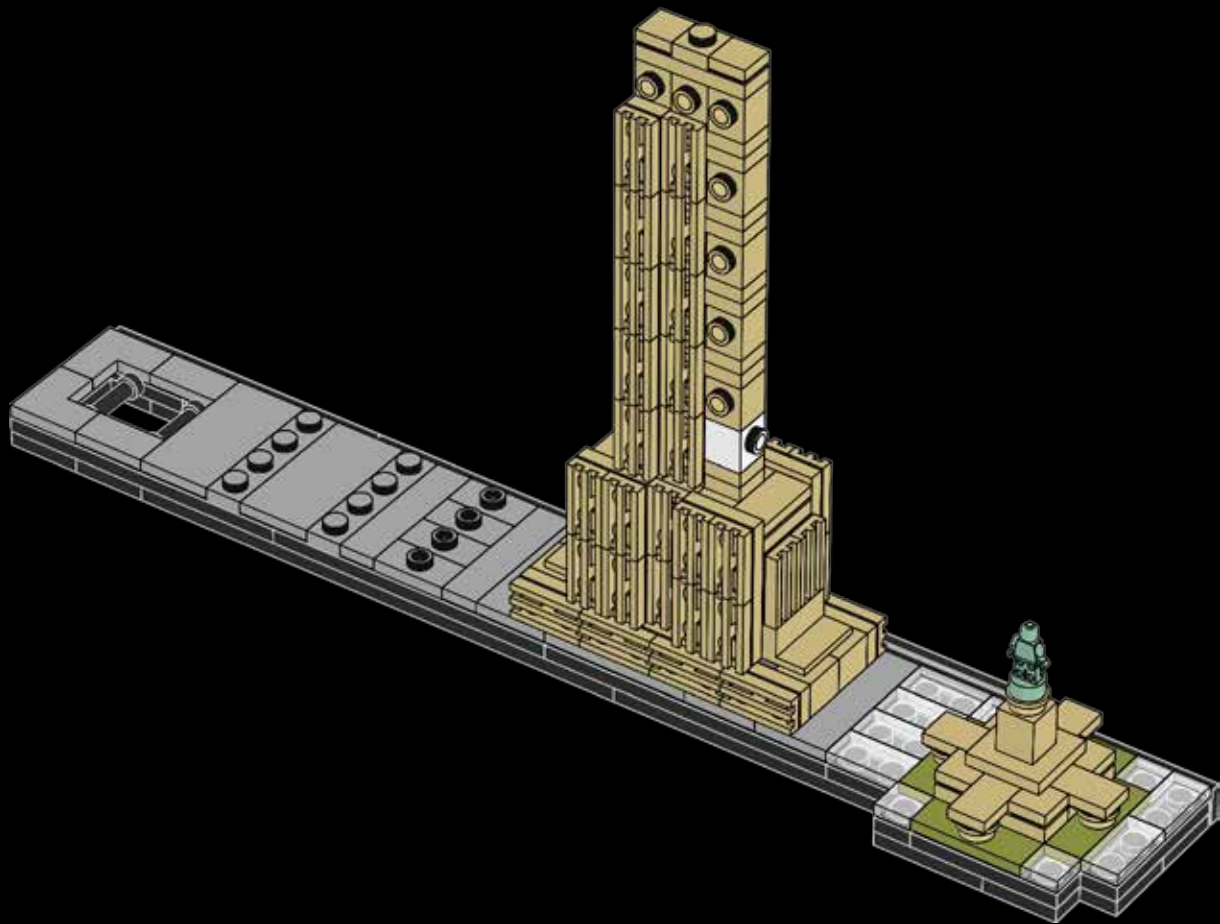

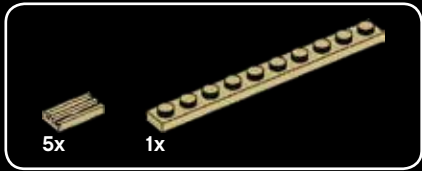

39

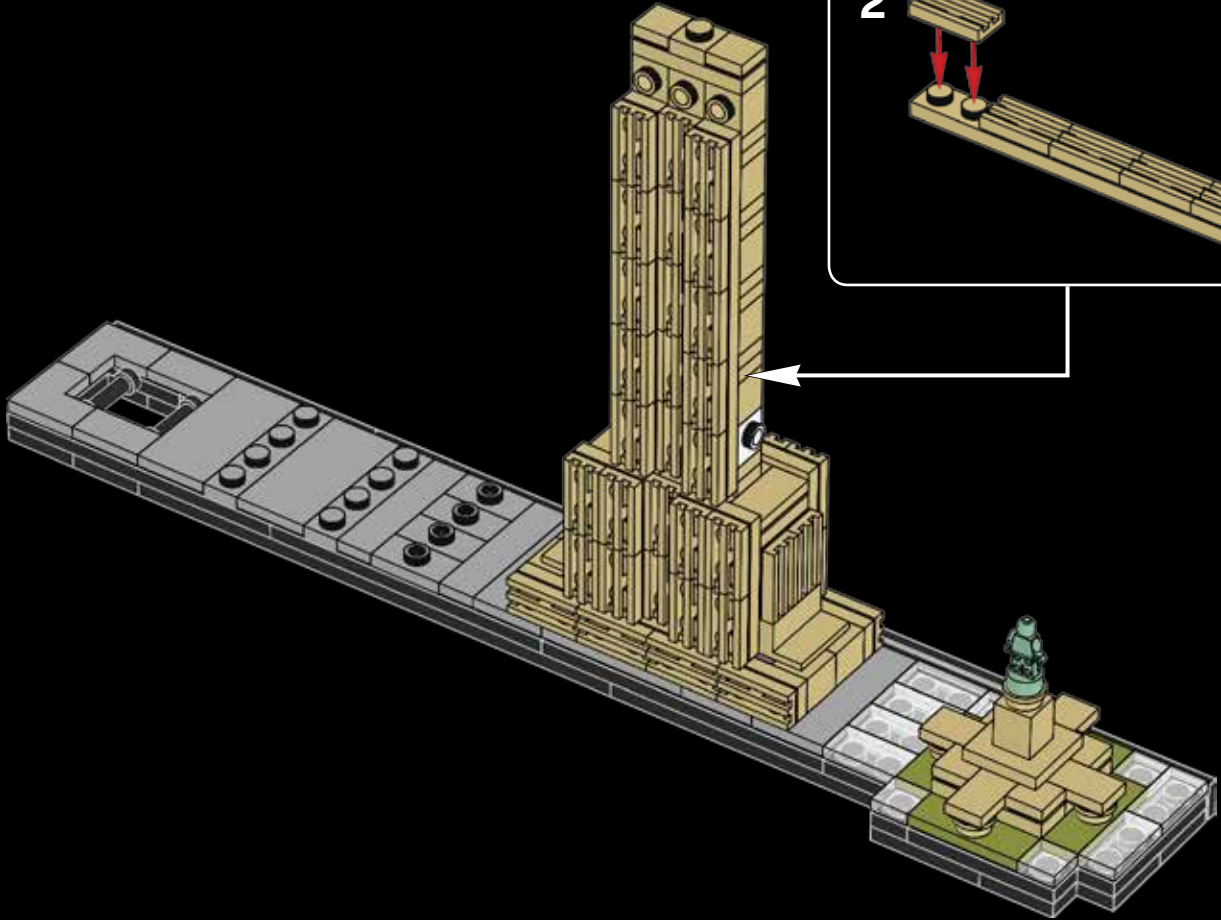
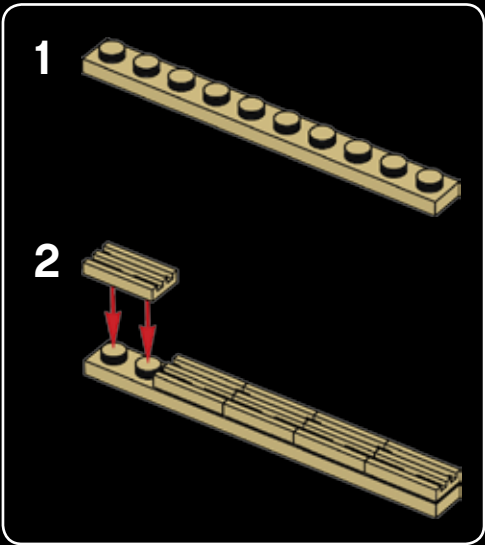



40

There are 6,514 windows
in the Empire State Building.



© Empire State Realty Trust, Inc.

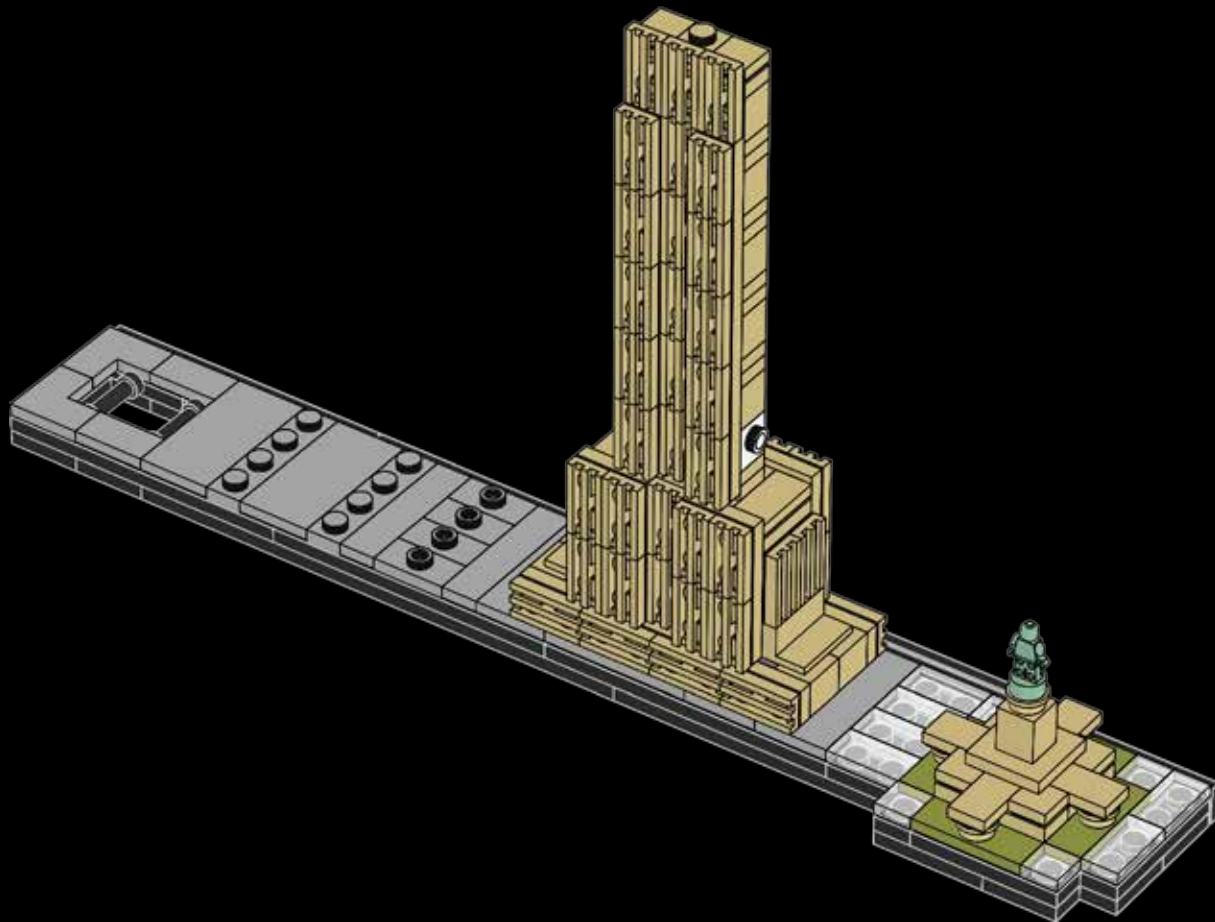

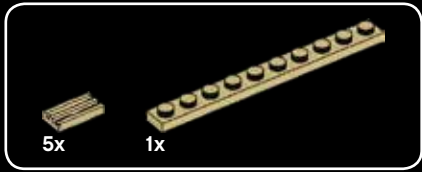

41

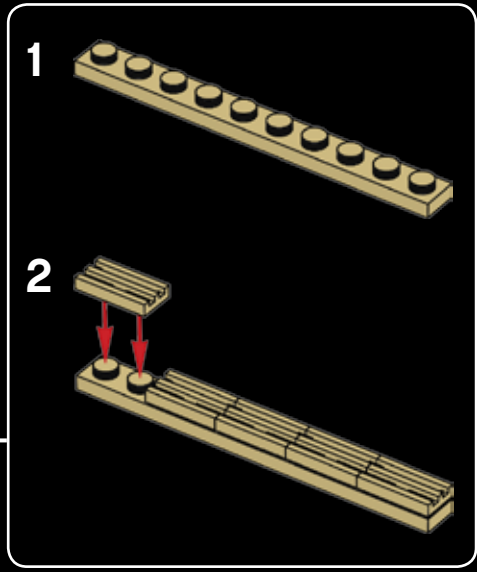
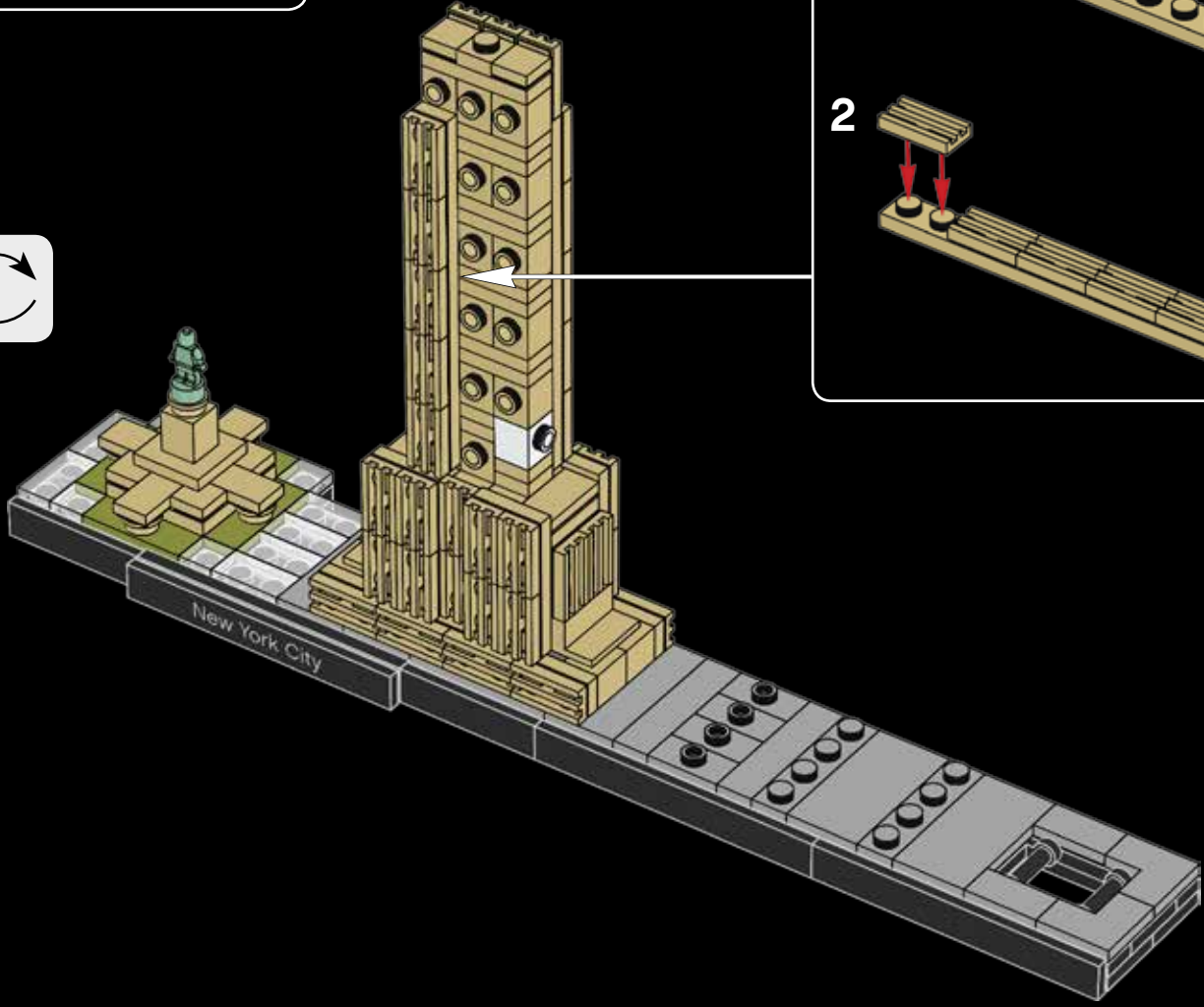



42

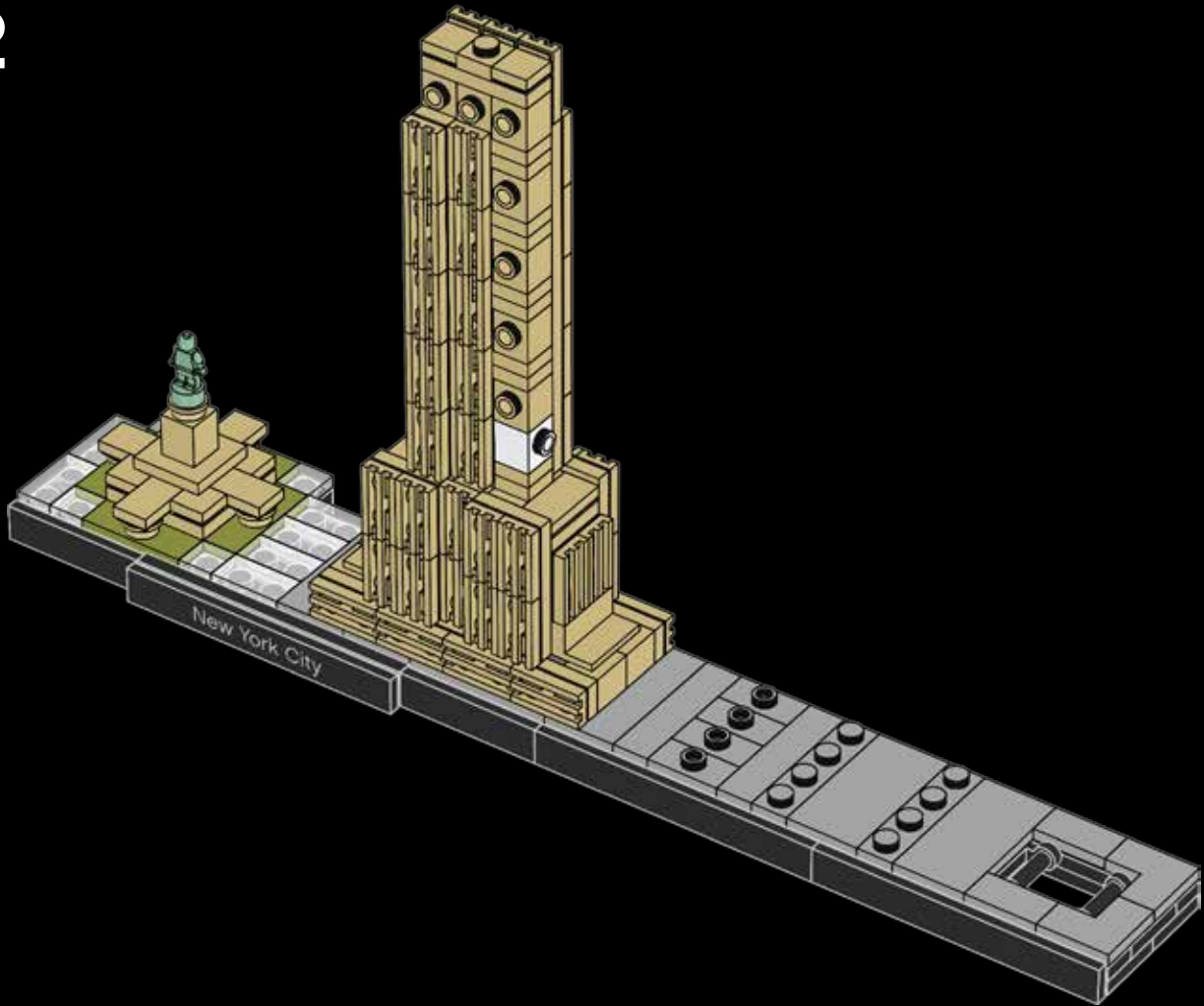

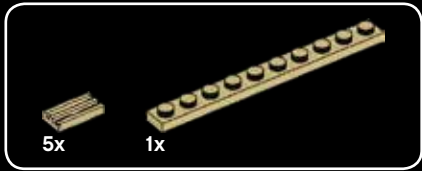

43

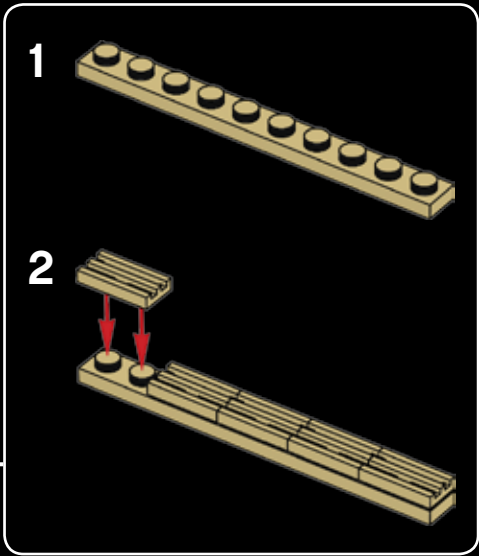
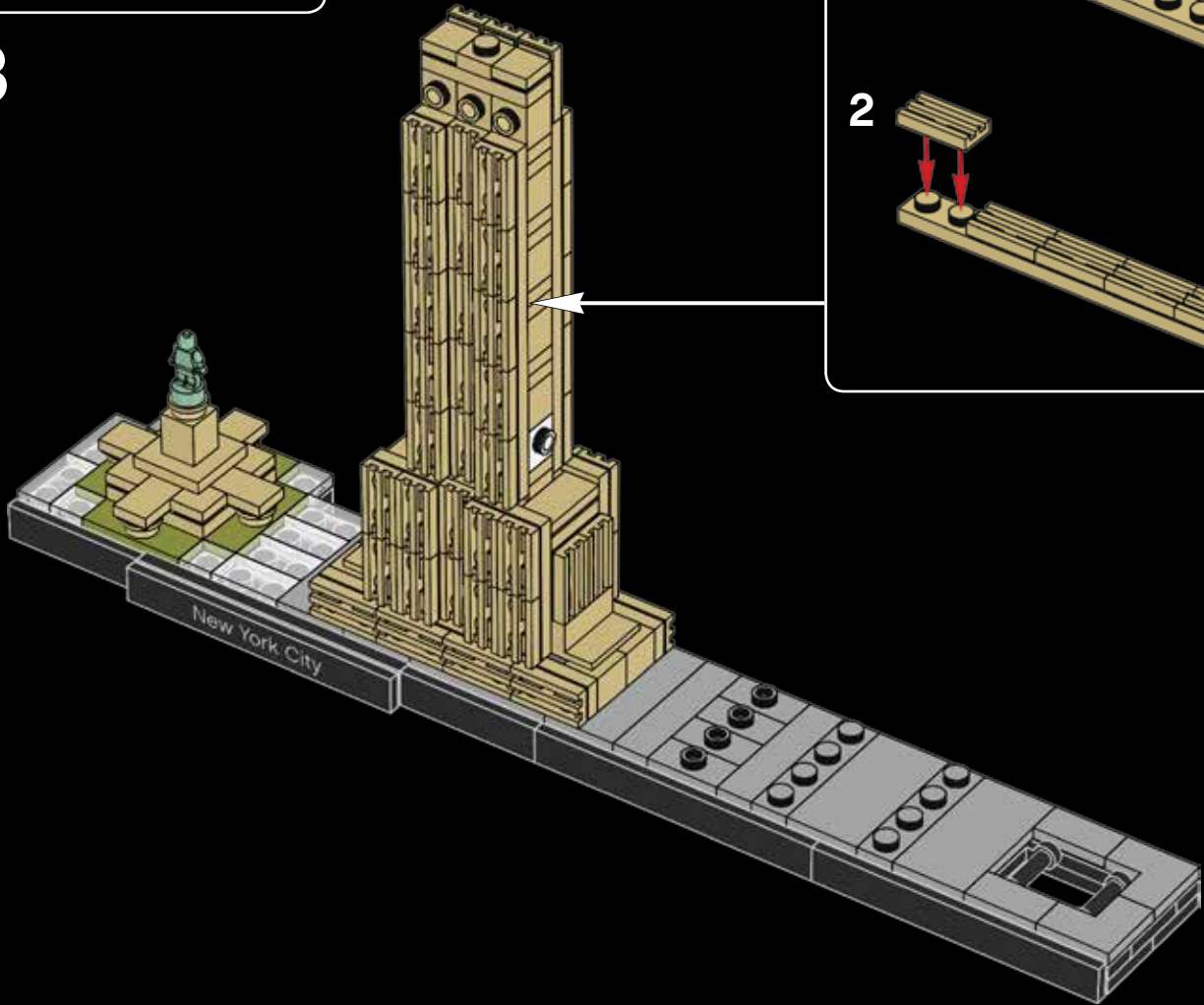



44

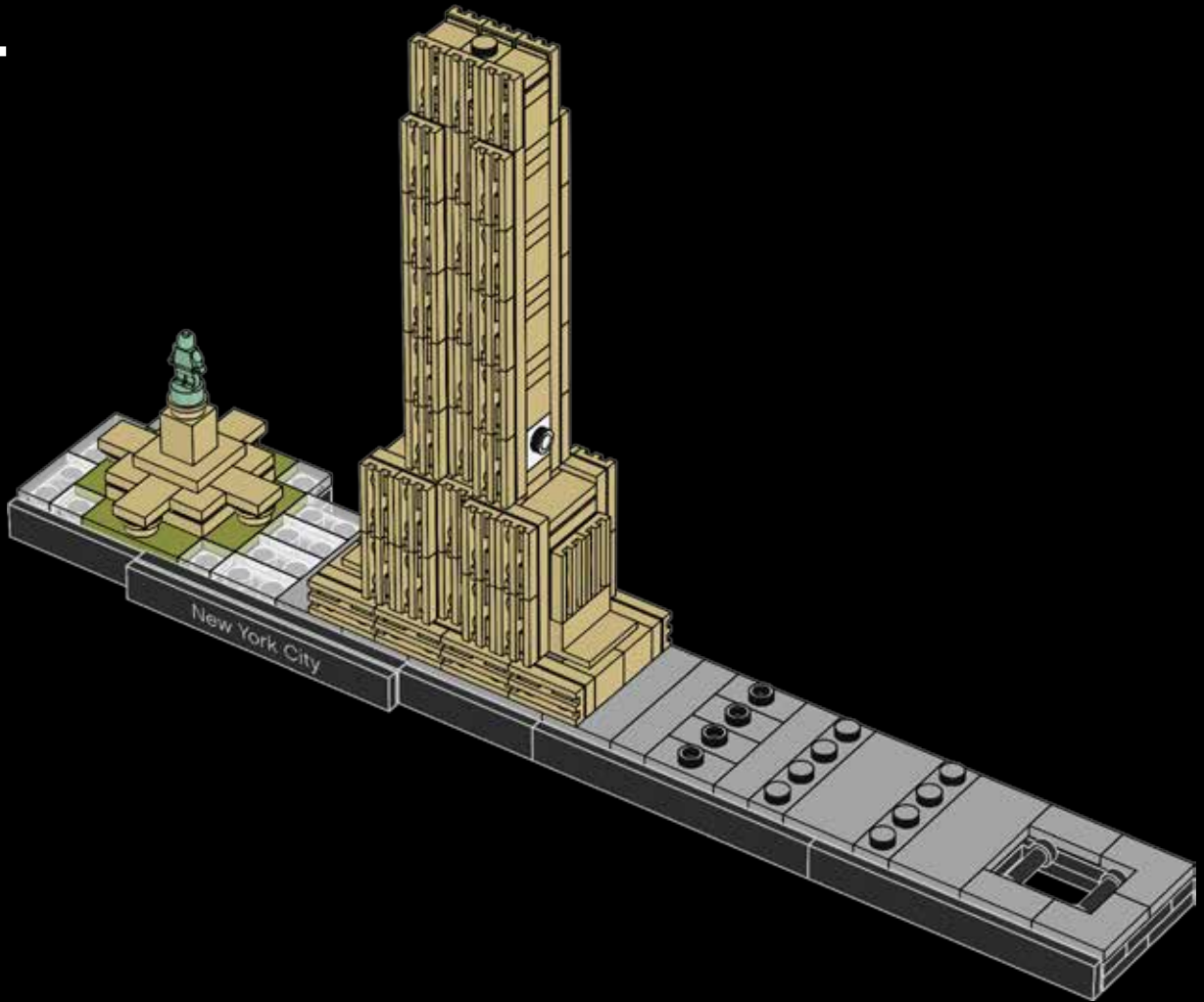



4x



4x

45

1



2

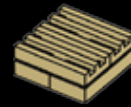

2x

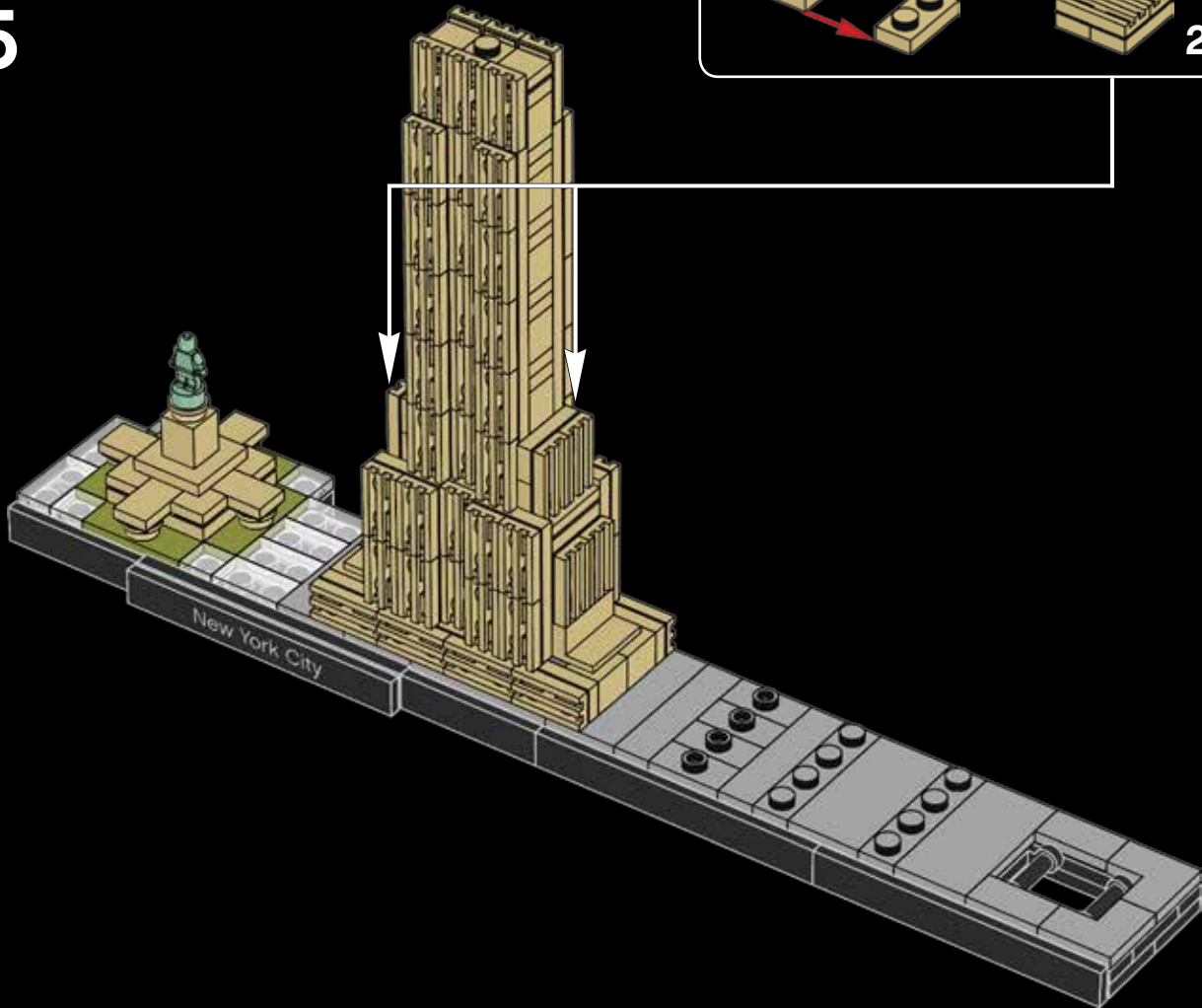

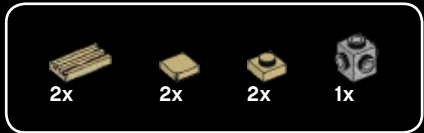

46

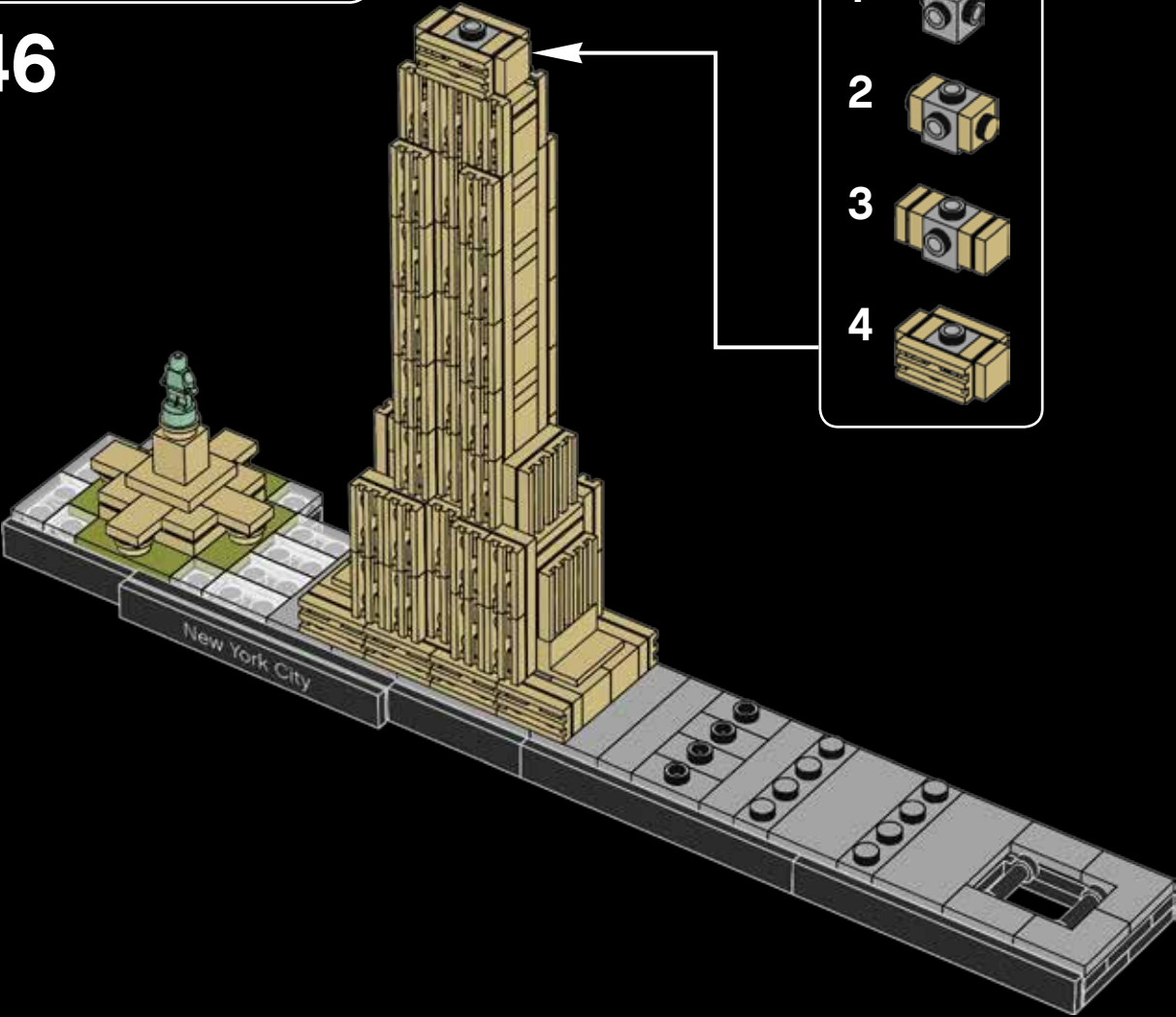

- 1
- 2
- 3
- 4



1x

47

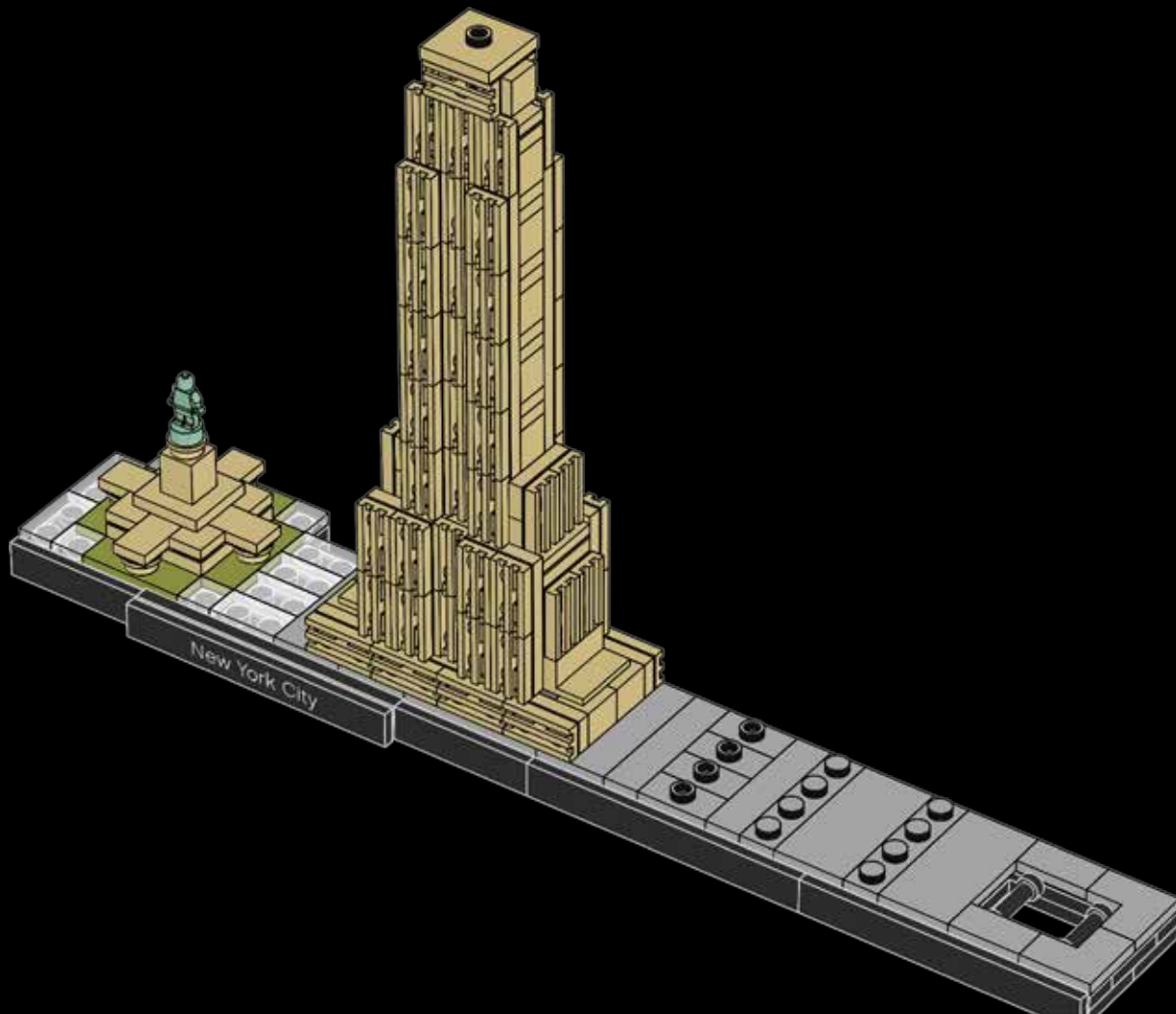

The Empire State Building has a lightning rod near the top which is struck by lightning around 23 times every year.



© Everett Historical

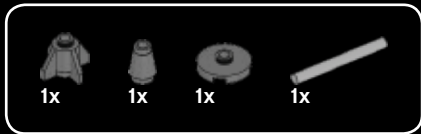

48

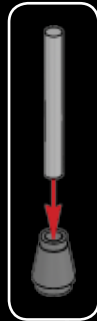

1



2



3

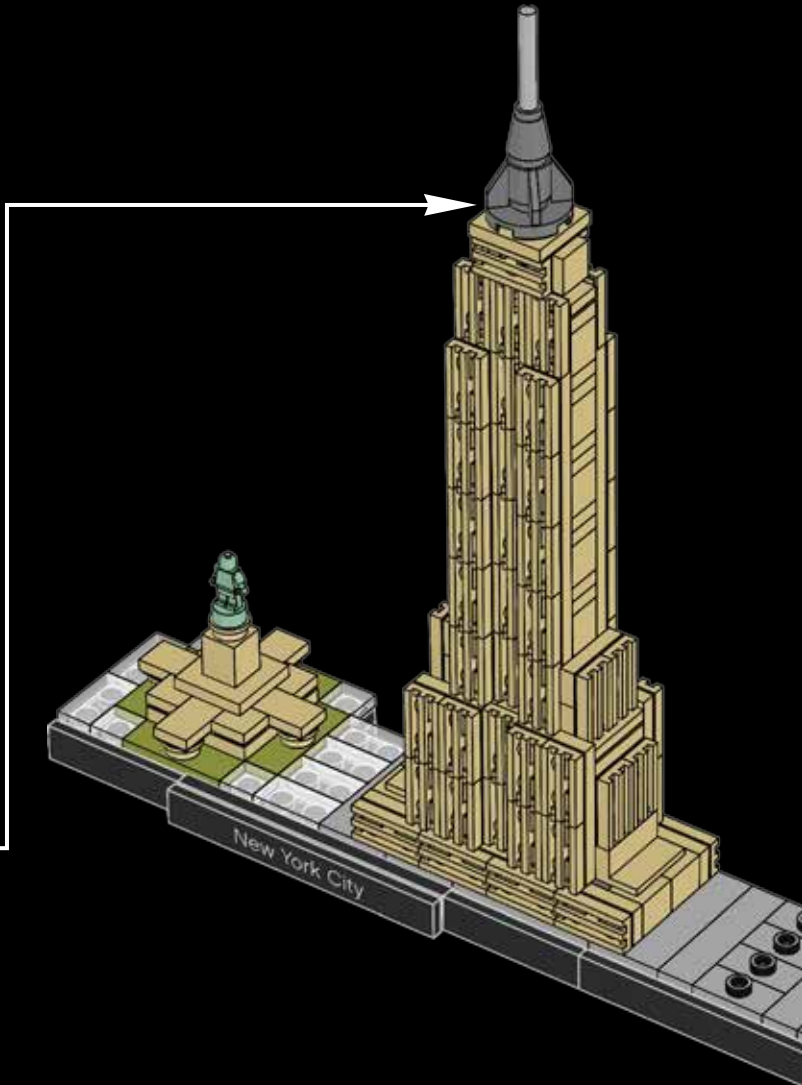
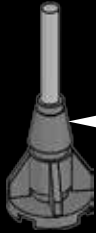



4x

49

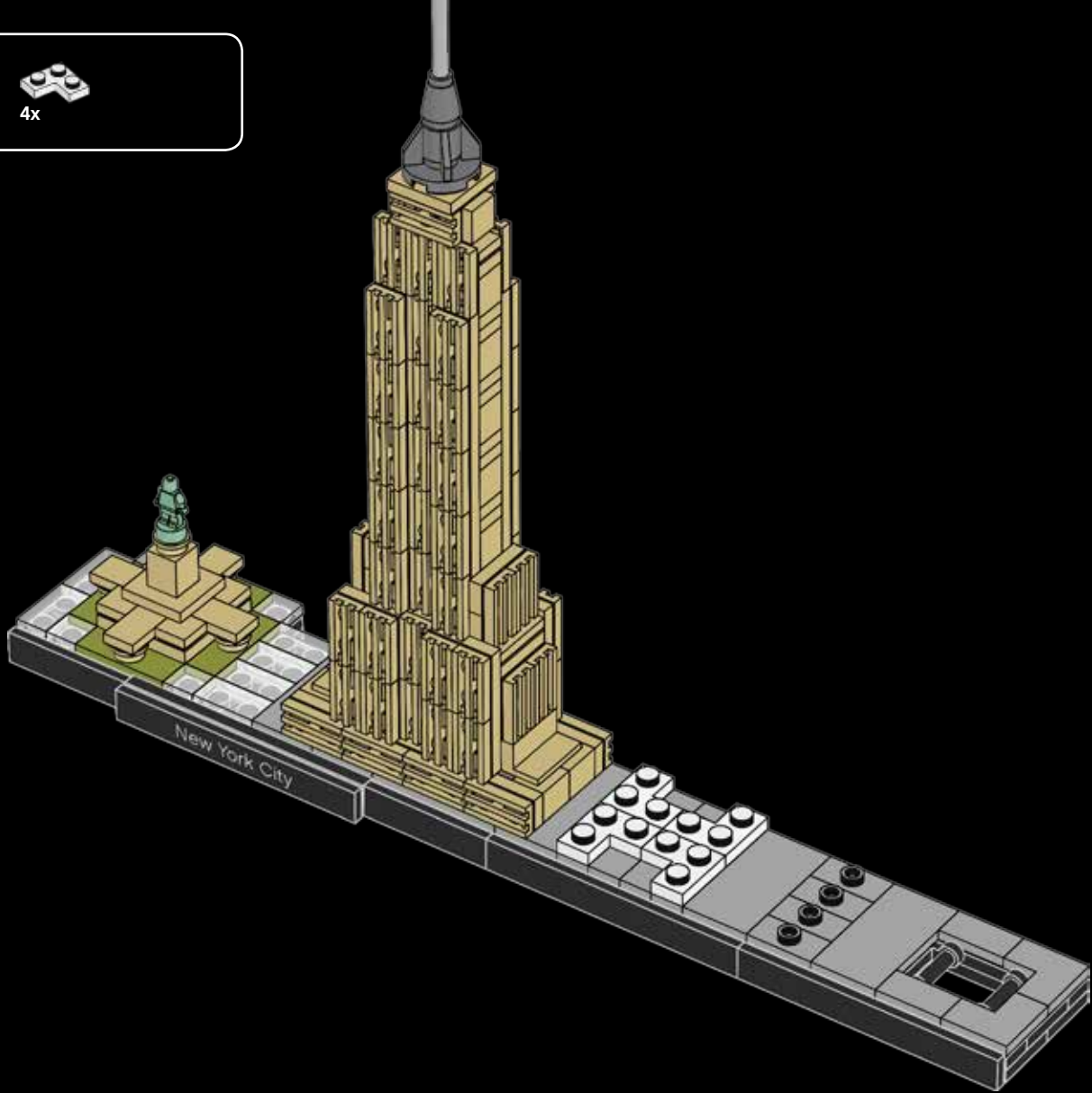



50

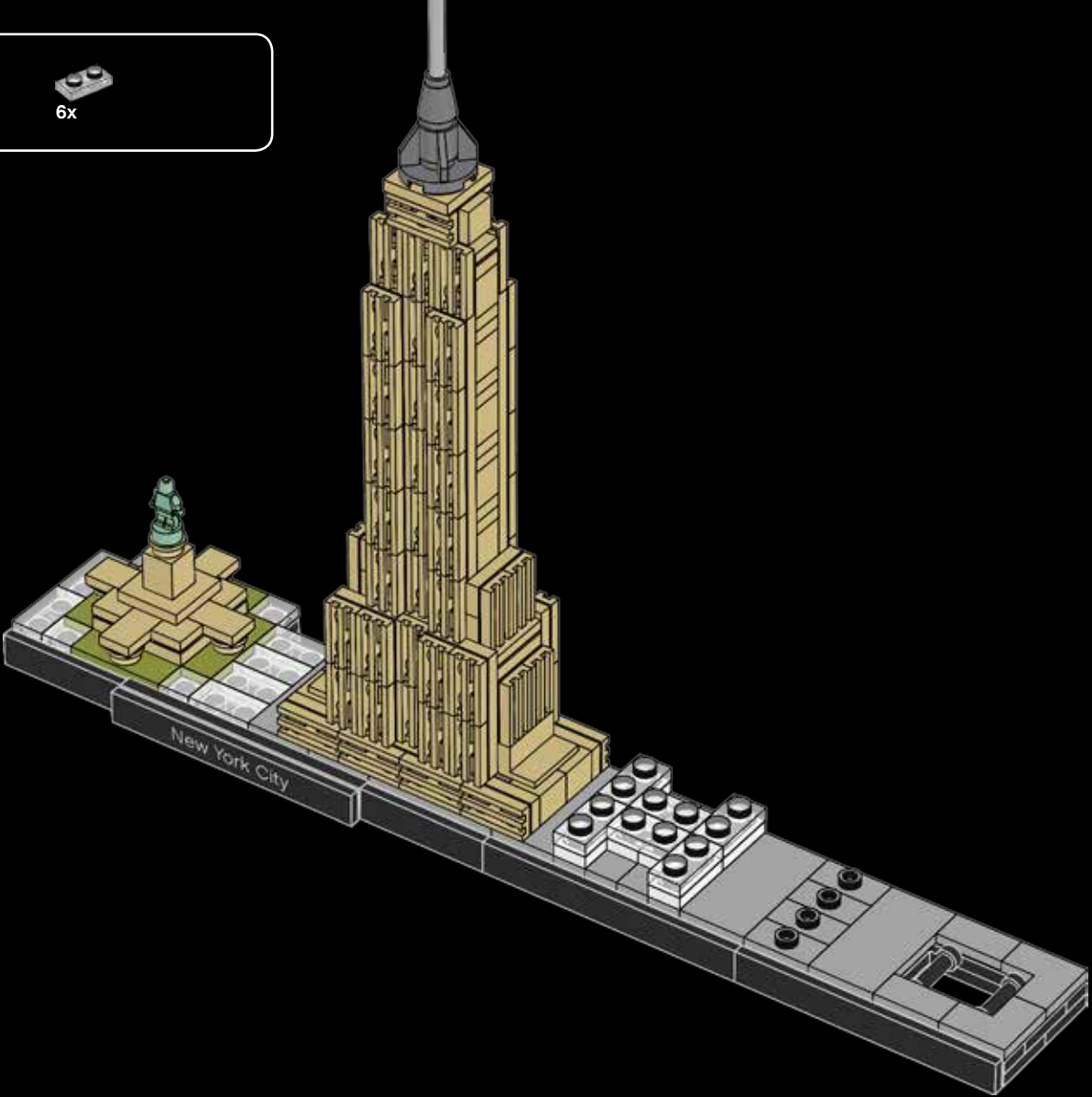

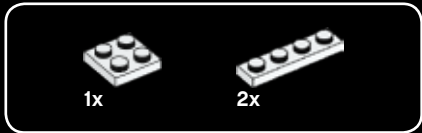

51

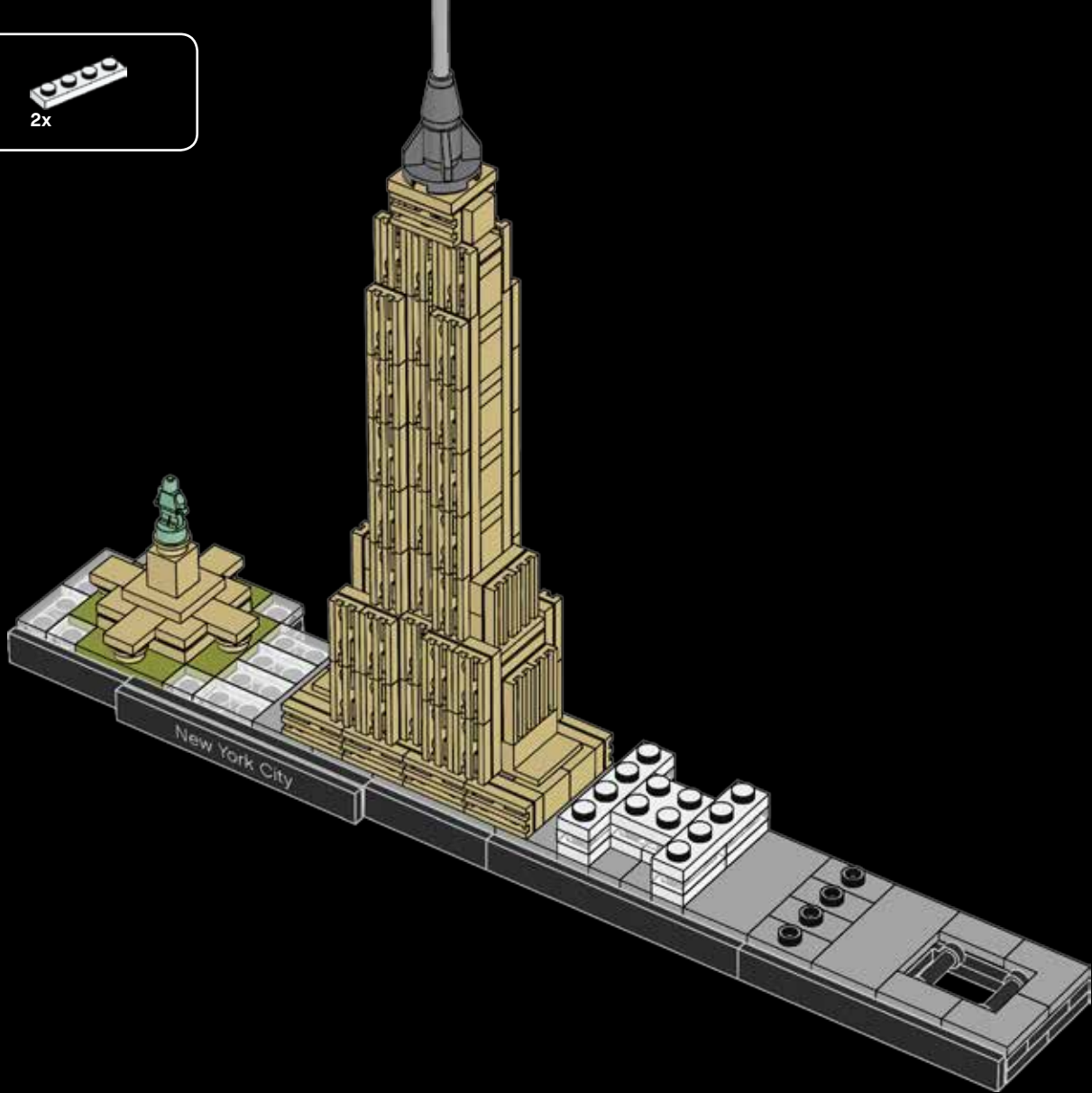



52

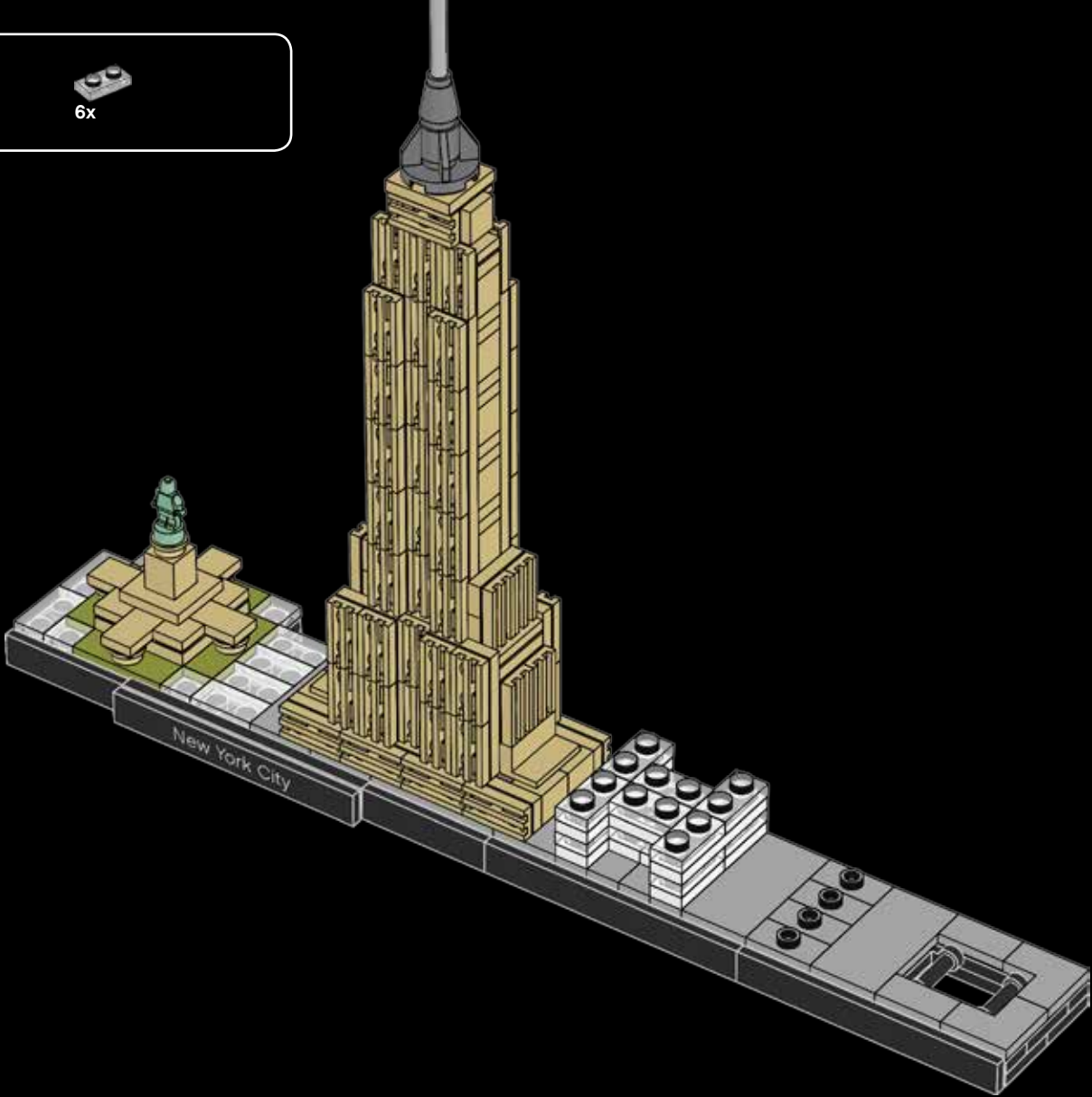



1x



4x

53

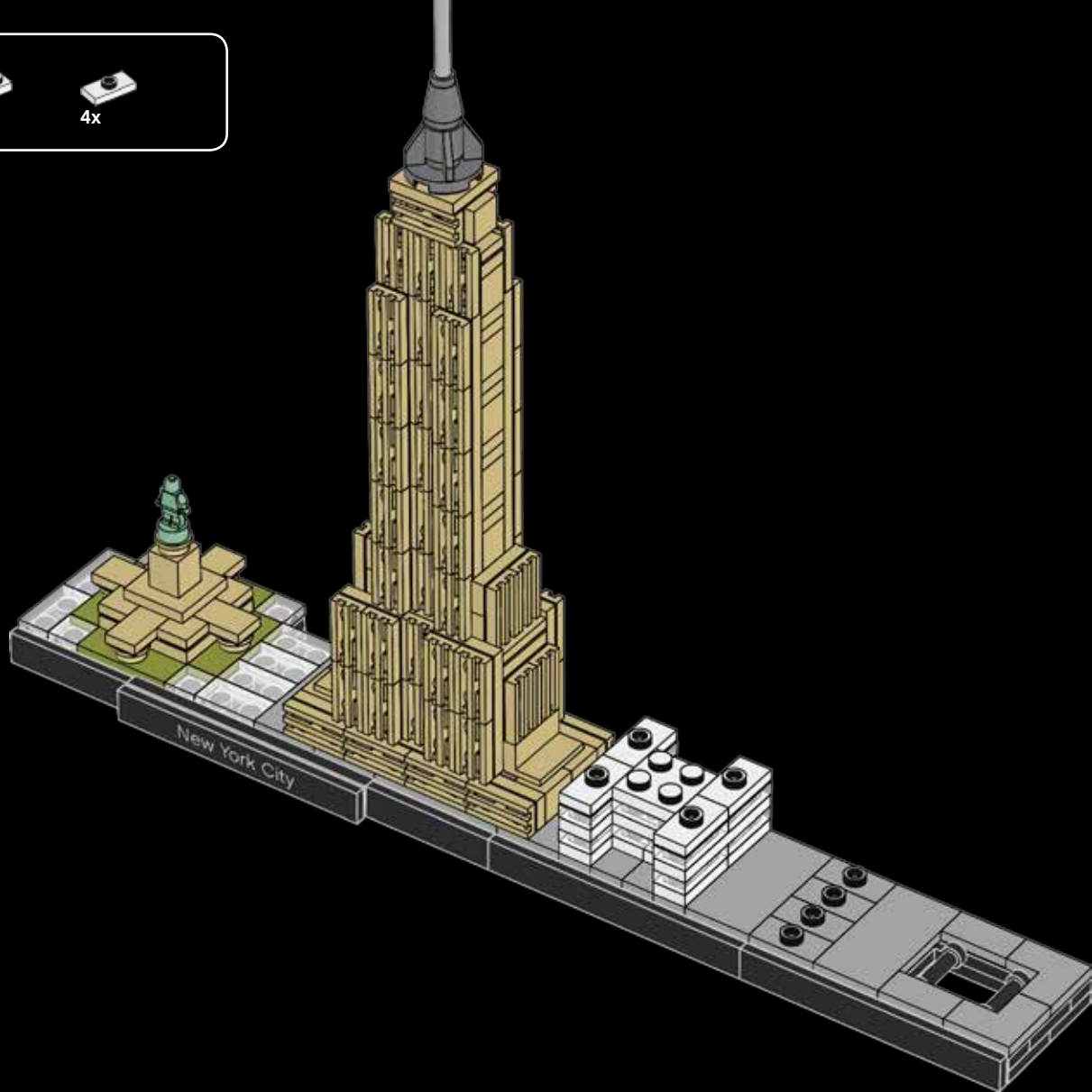



2x

54





4x

55

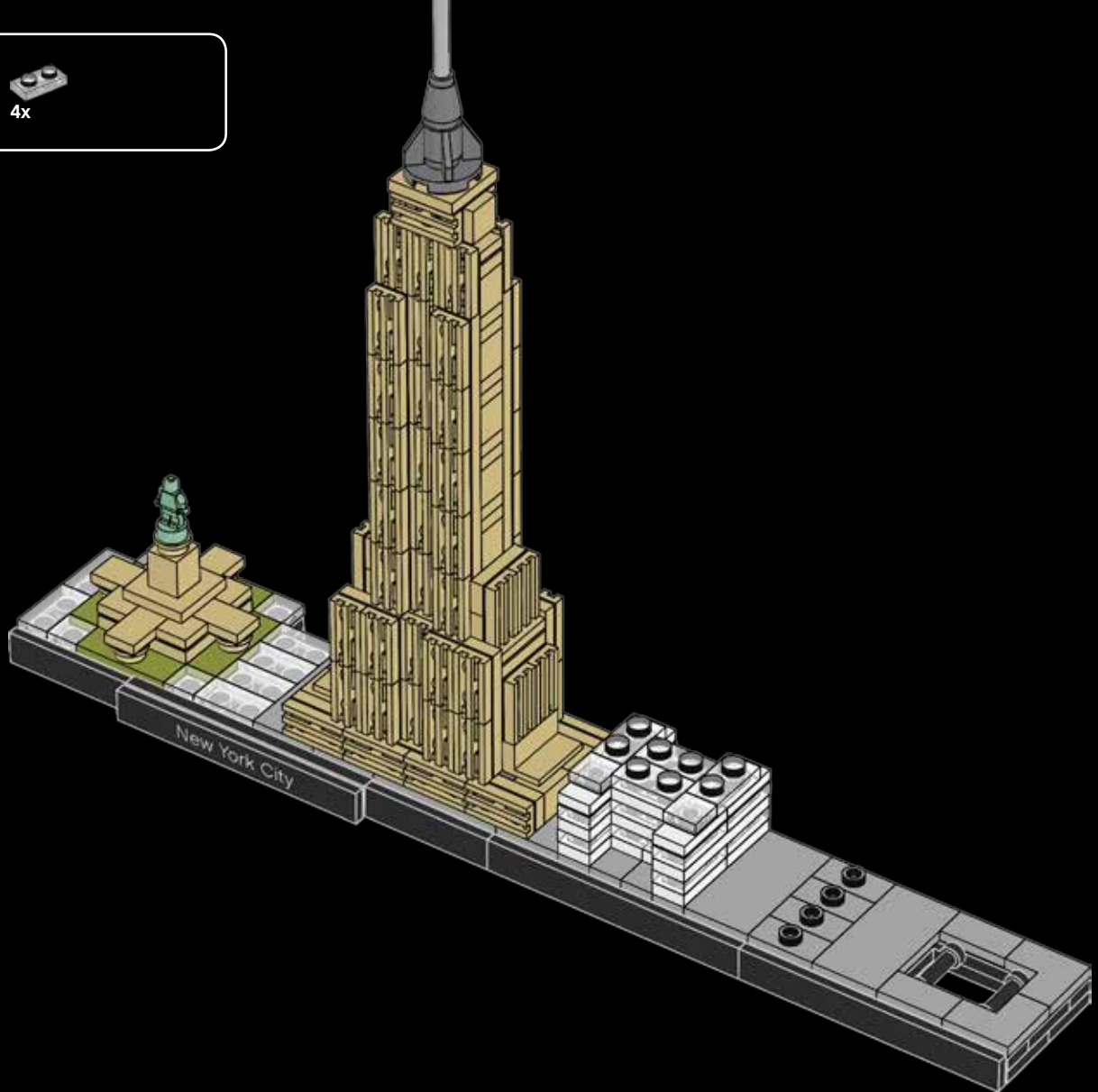



2x

56

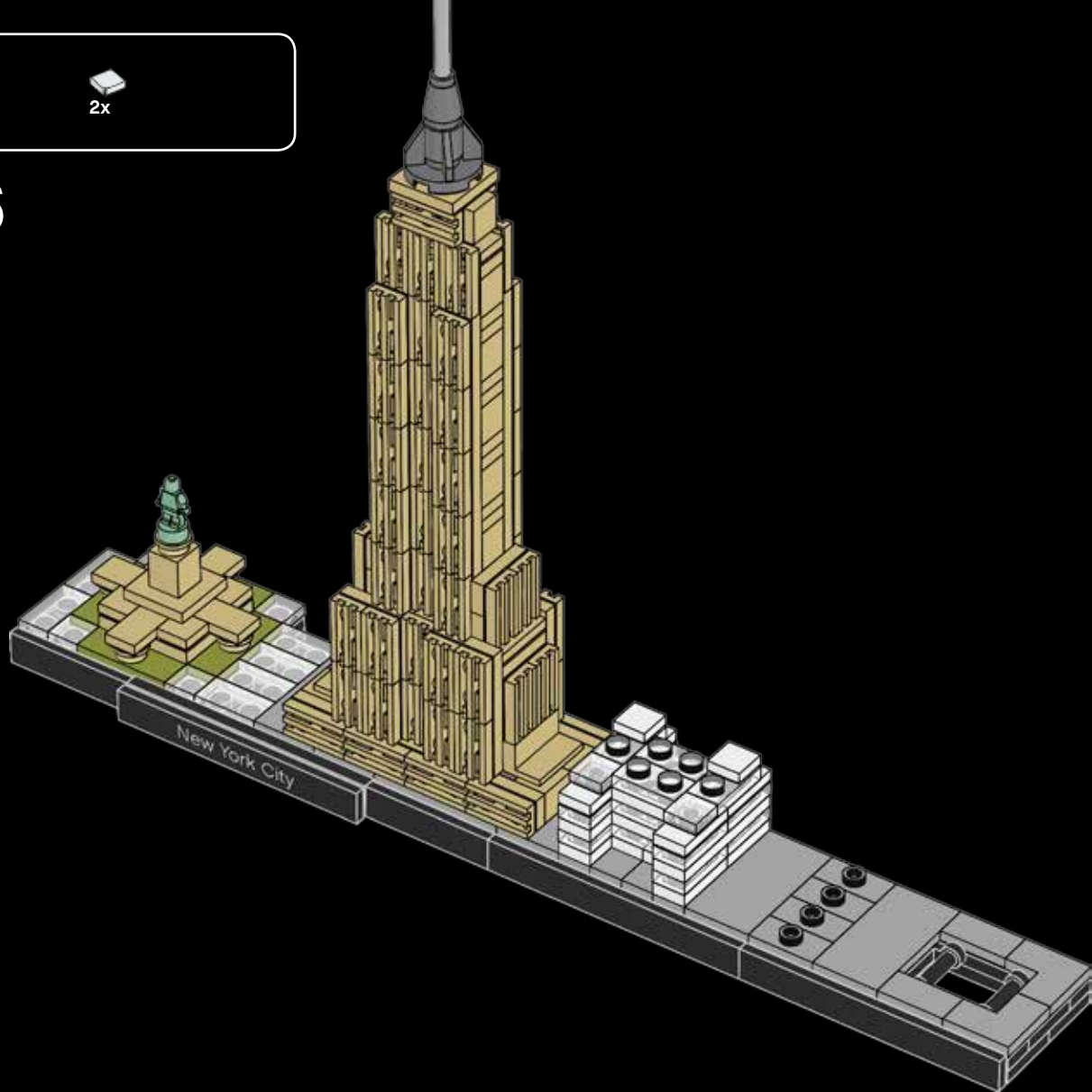



1x



2x

57

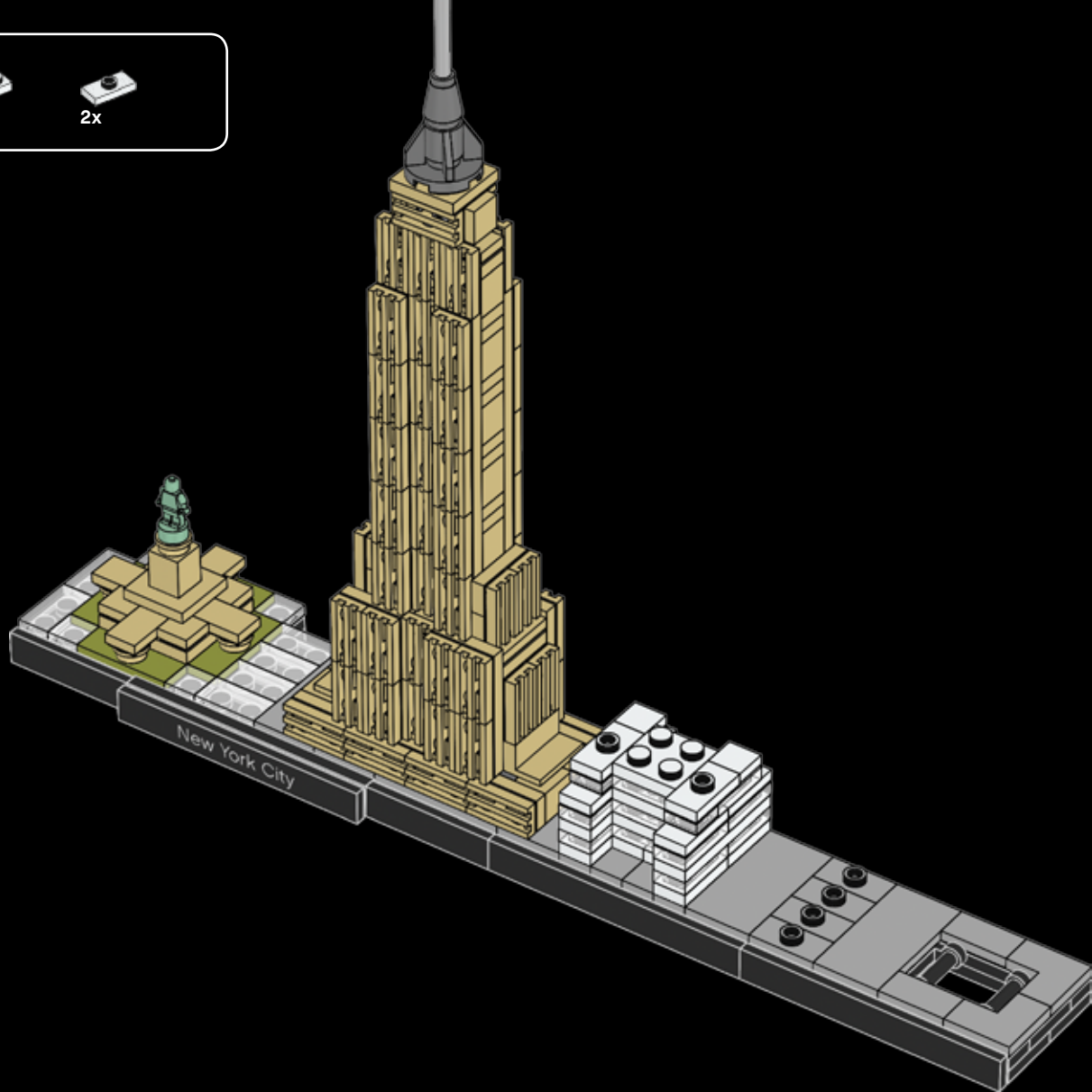



58

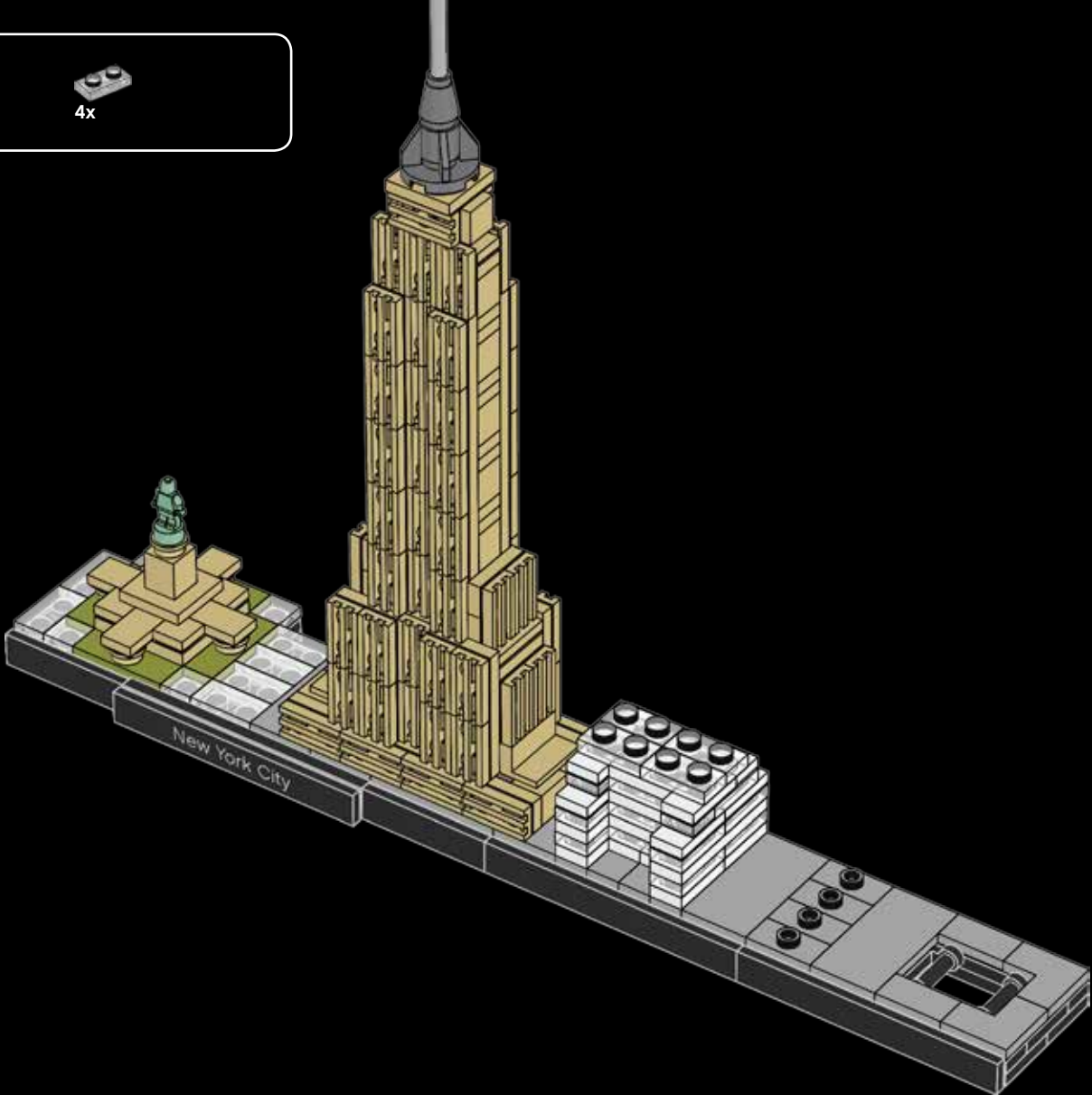



4x

59

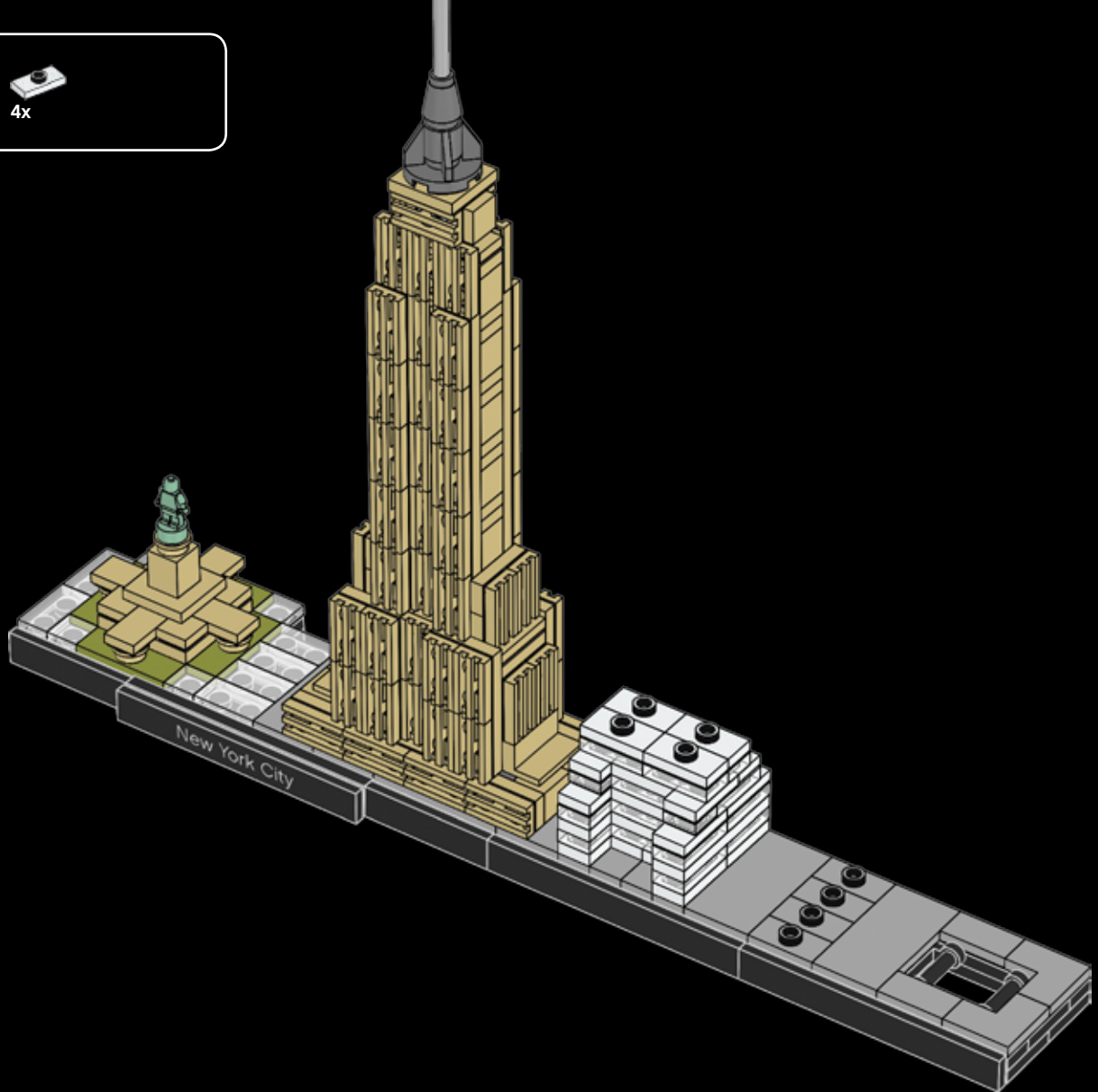



60

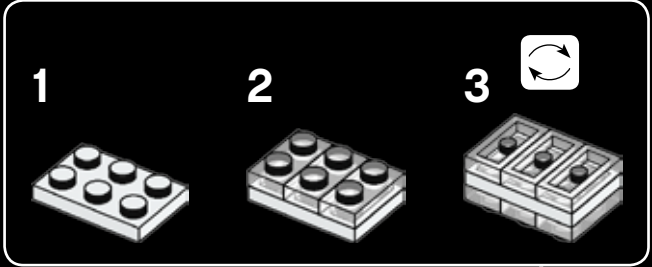
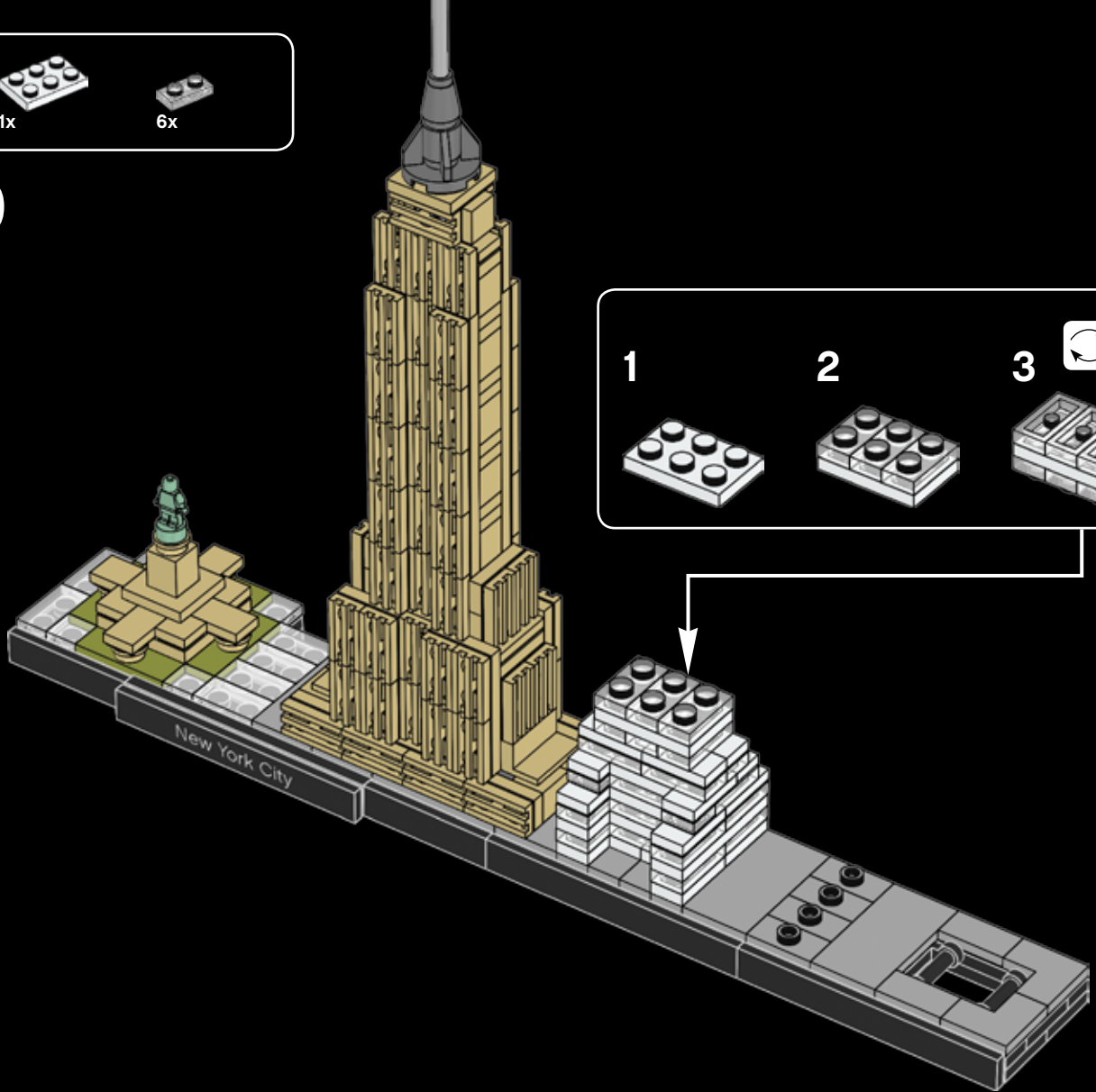

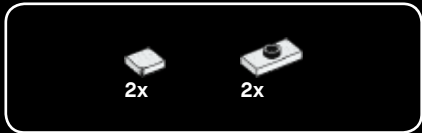

61

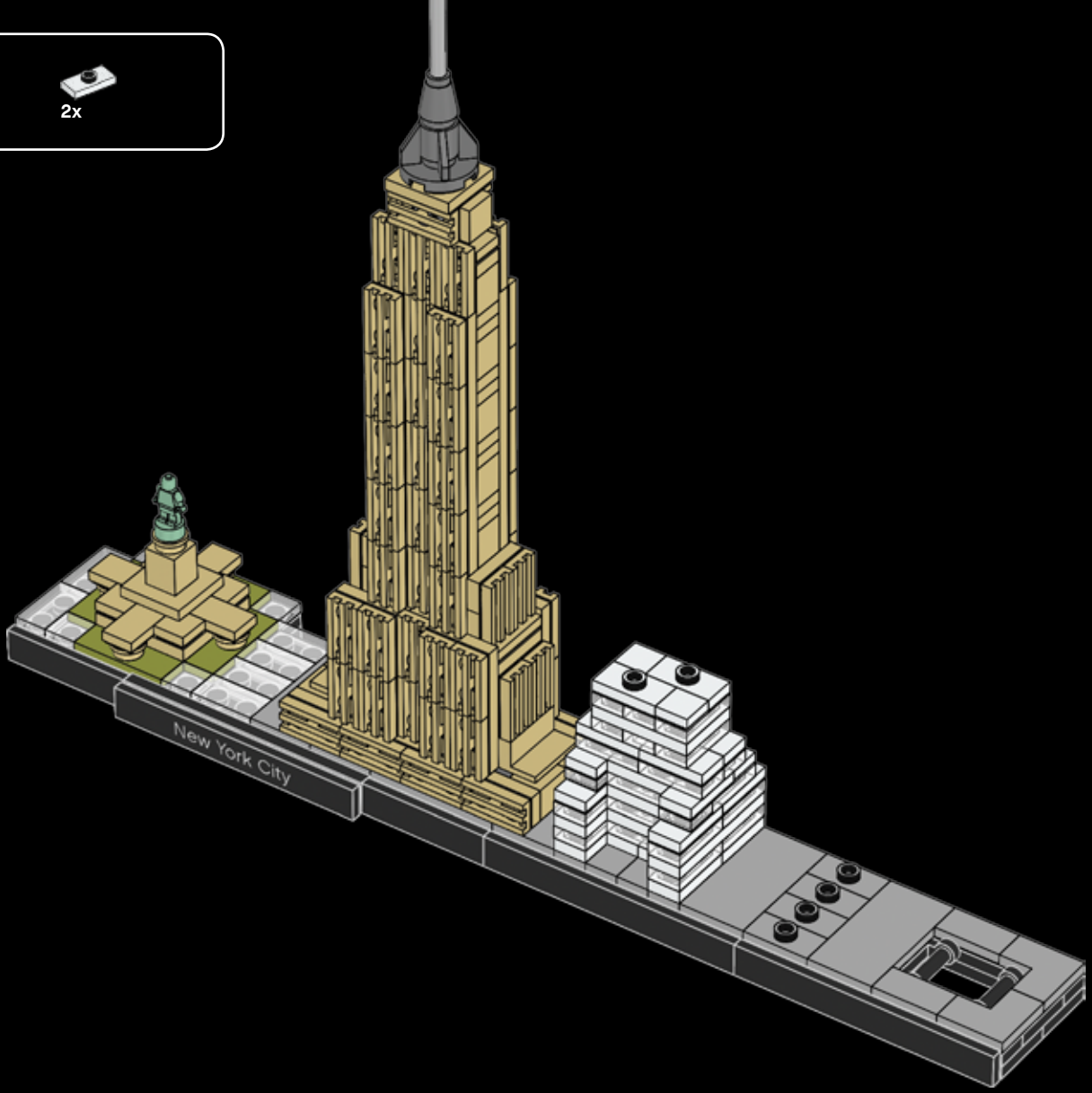



62

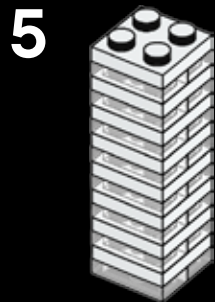
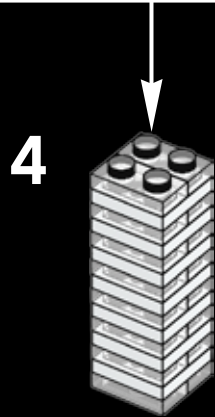
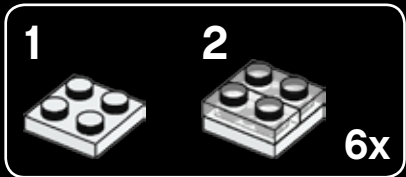
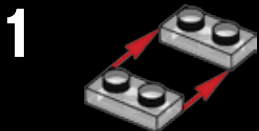

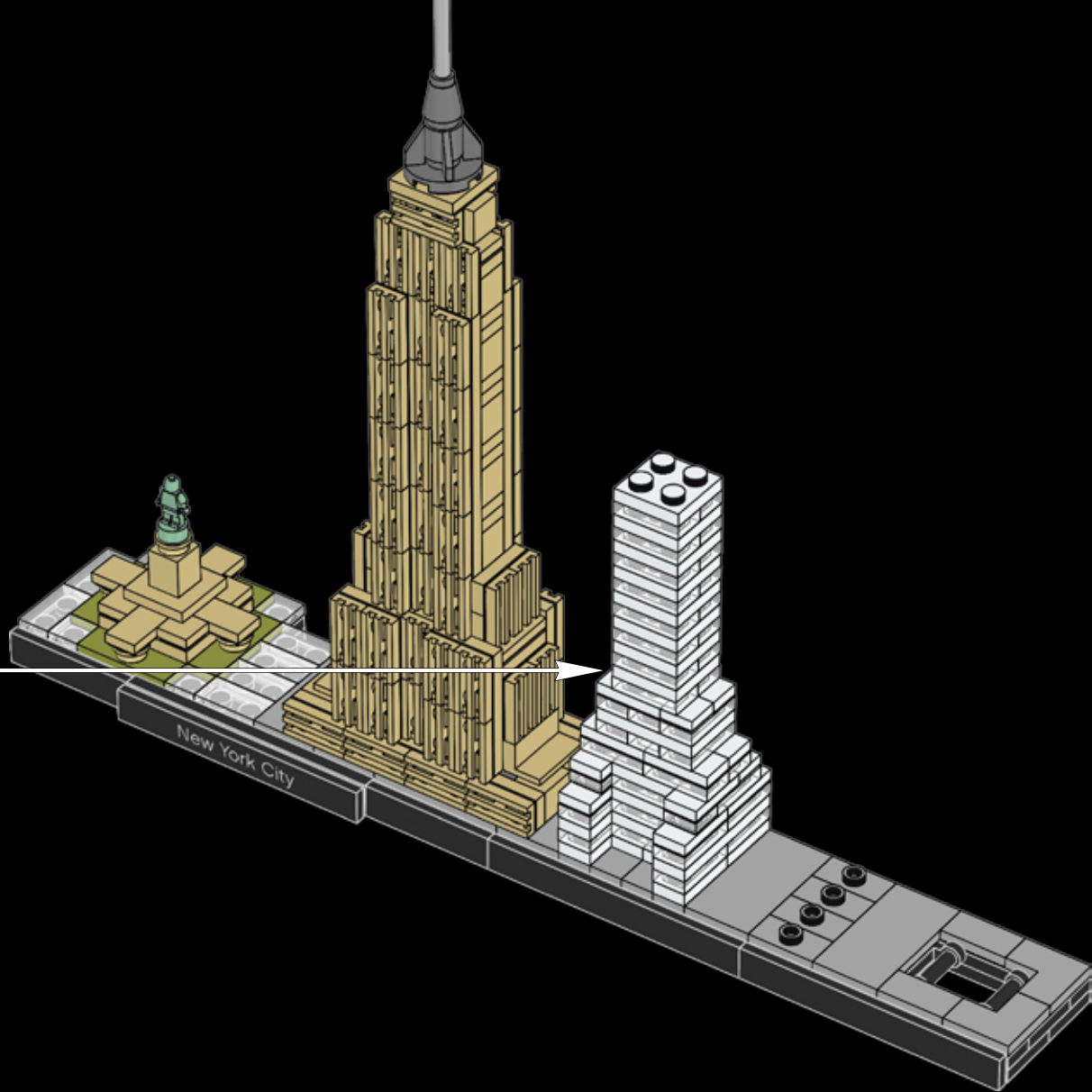



63

The entire crown
of the Chrysler Building™
is clad in stainless steel

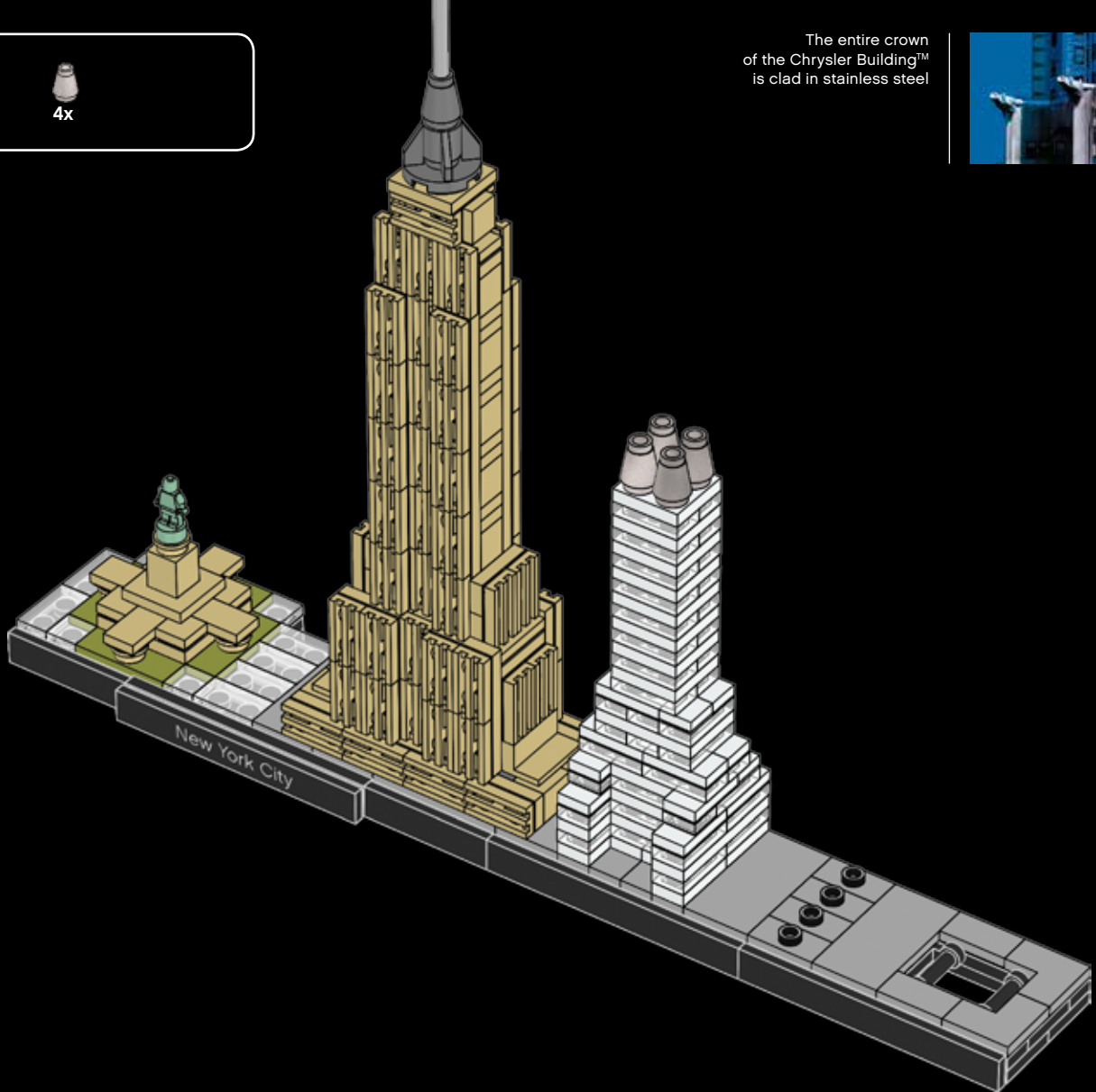



1x



1x

64

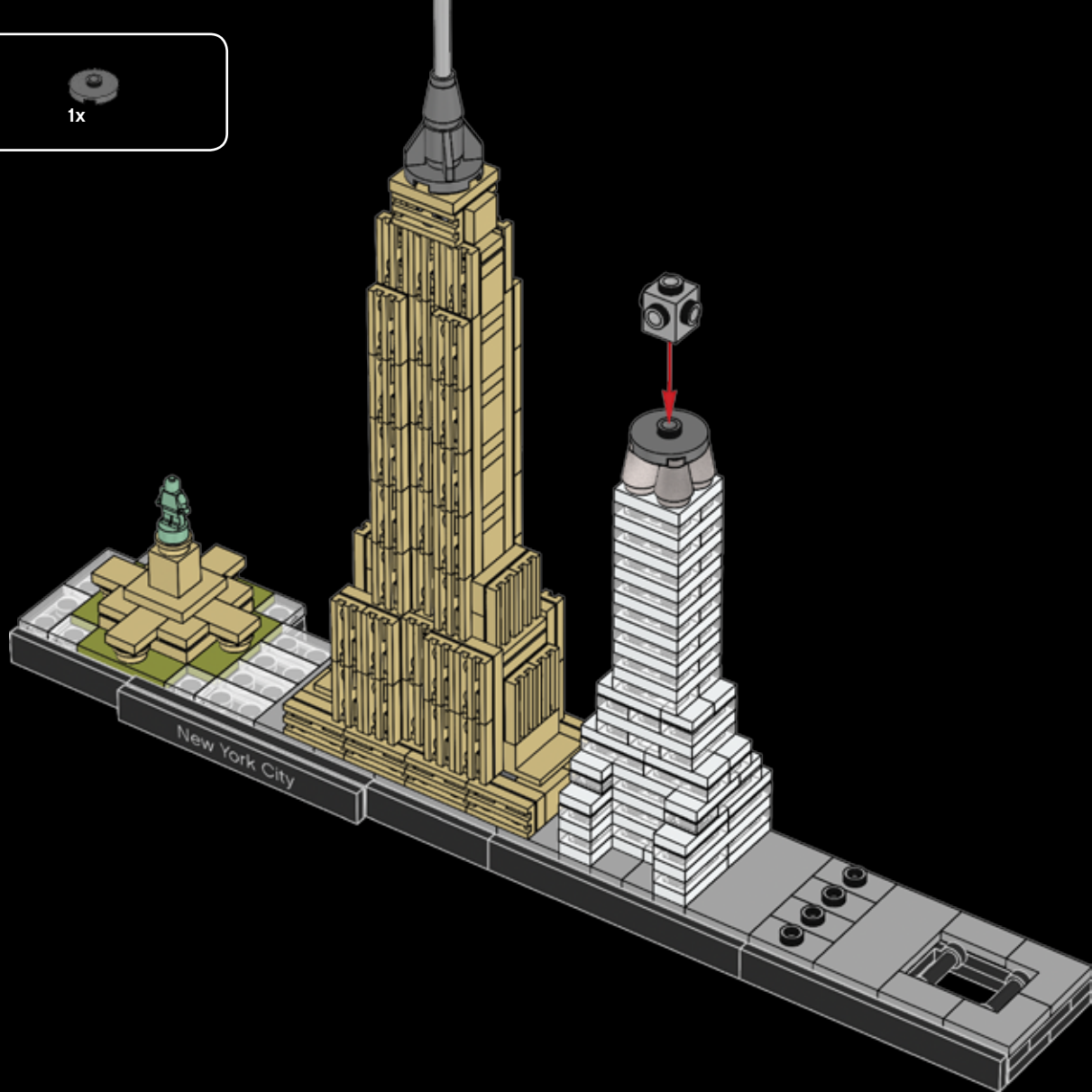

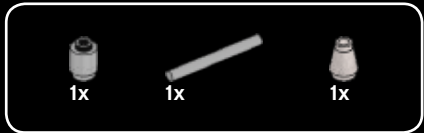

65

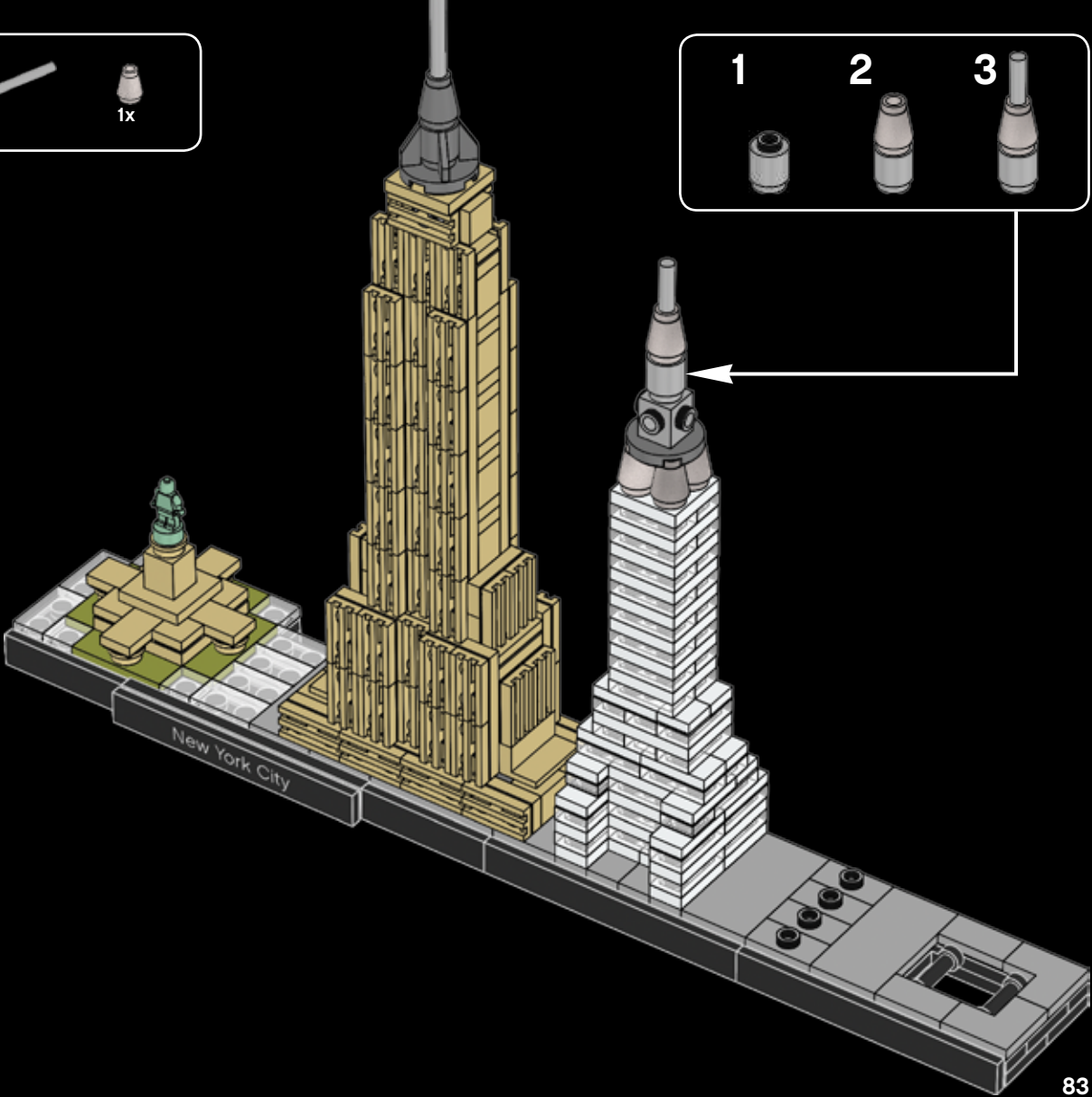



4x

66



4x

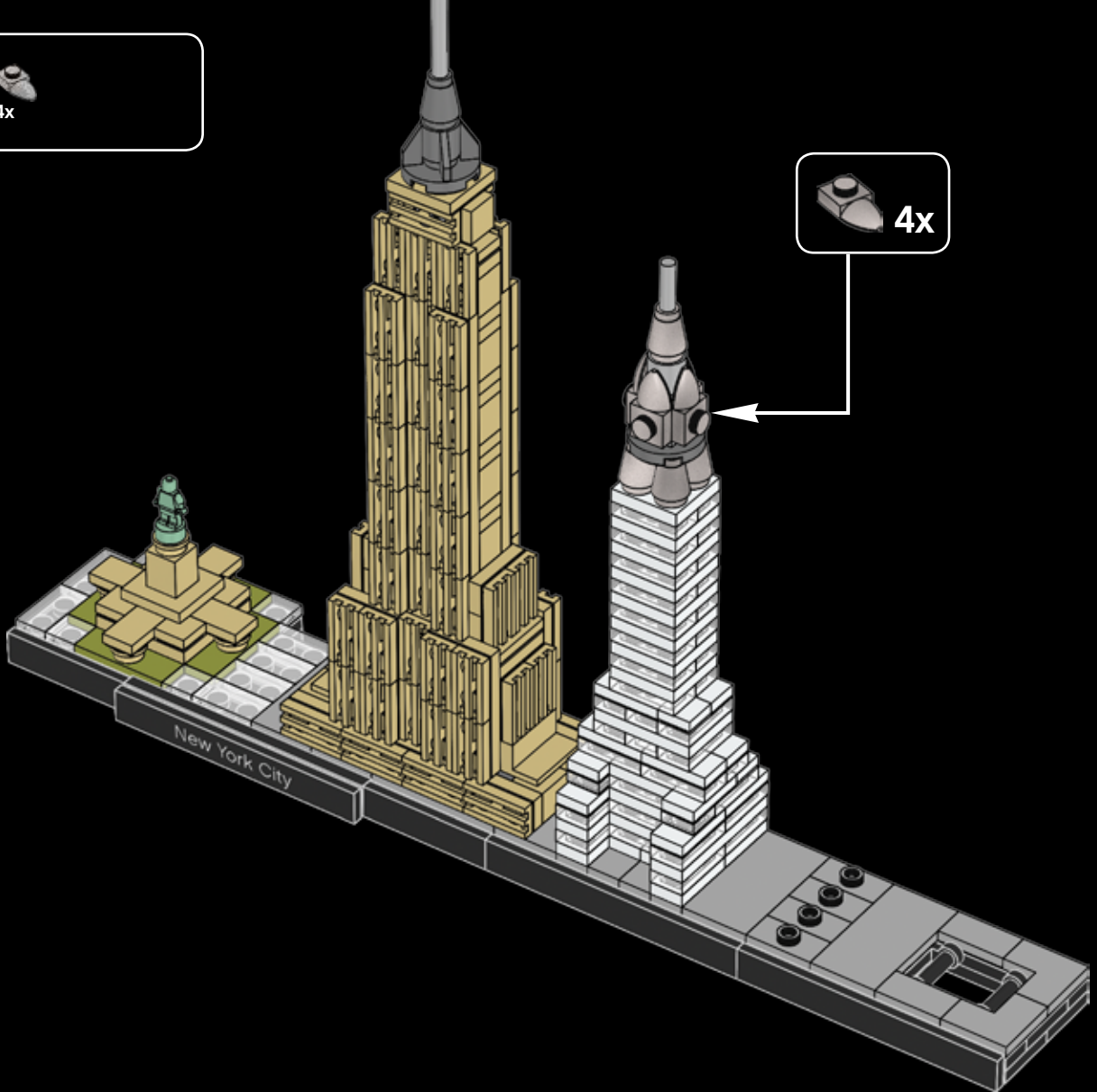



67

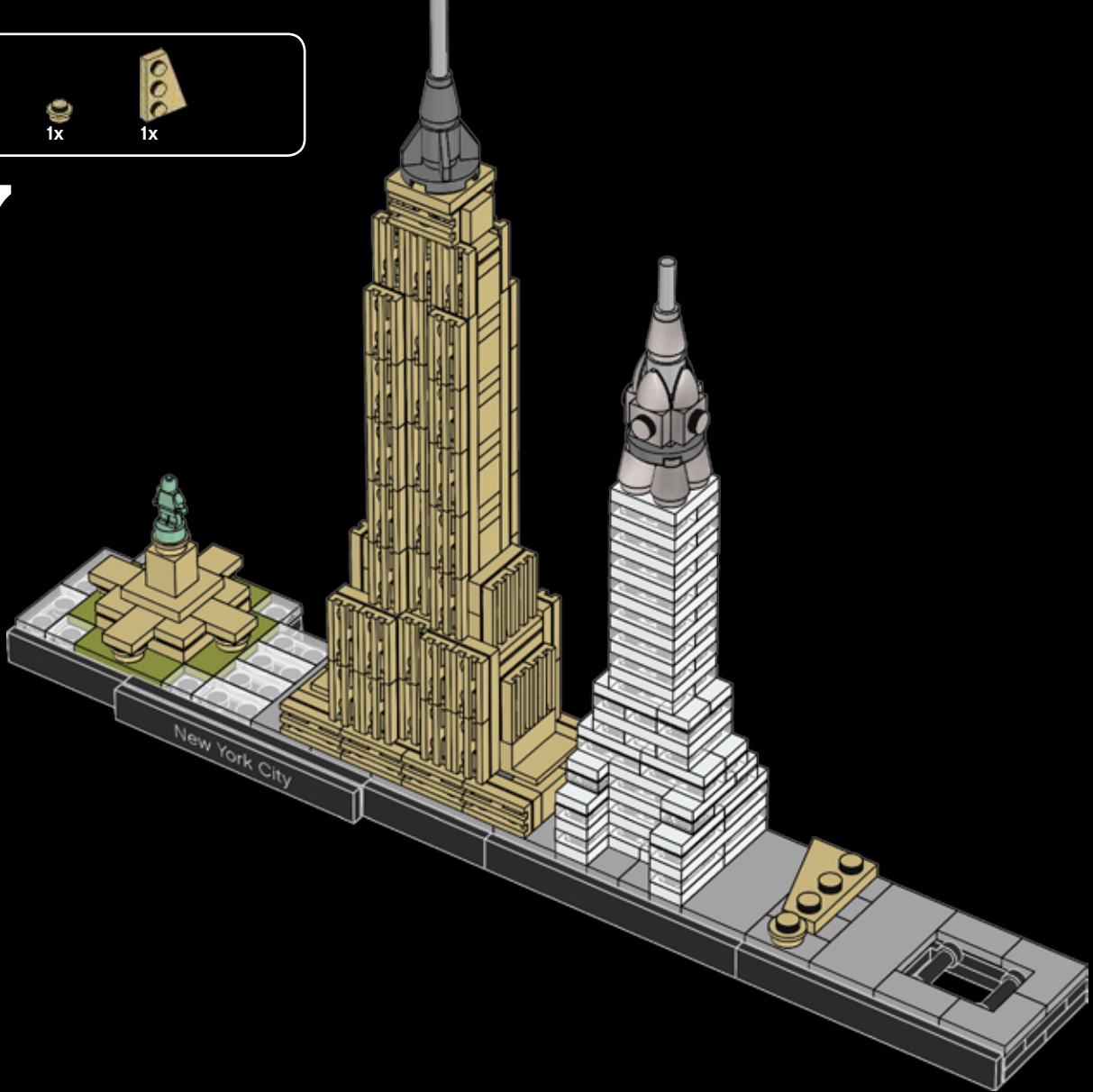

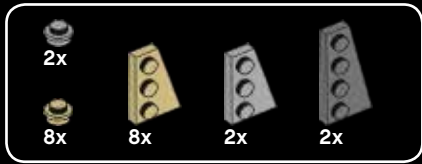

68

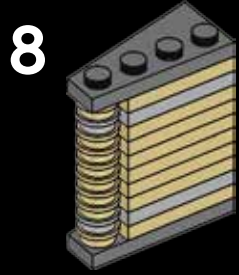
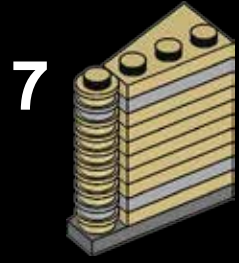
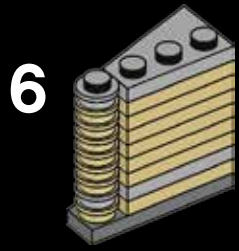
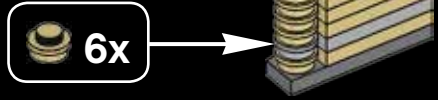
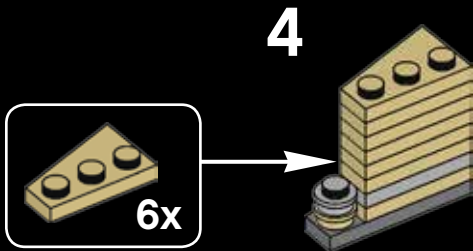
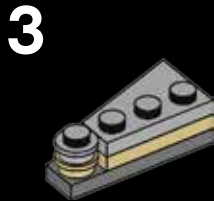
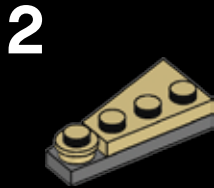
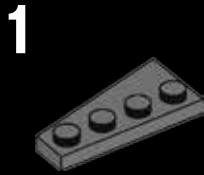

"I found myself agape,
admiring a sky-scraper...
plowing up through
the traffic of Broadway
and Fifth Avenue in the
afternoon light." H.G Wells



© Shutterstock

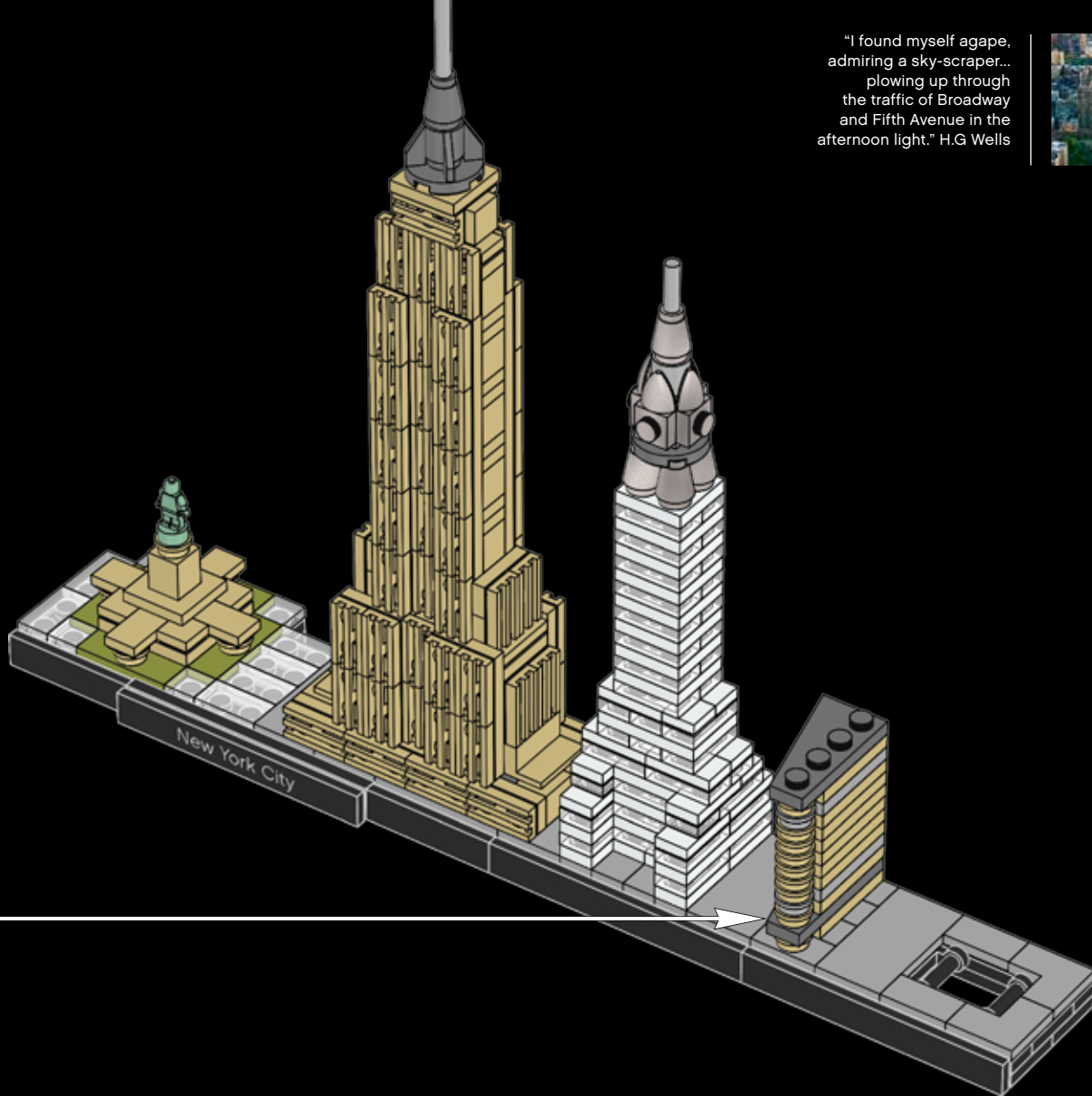

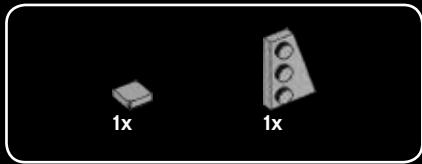

69

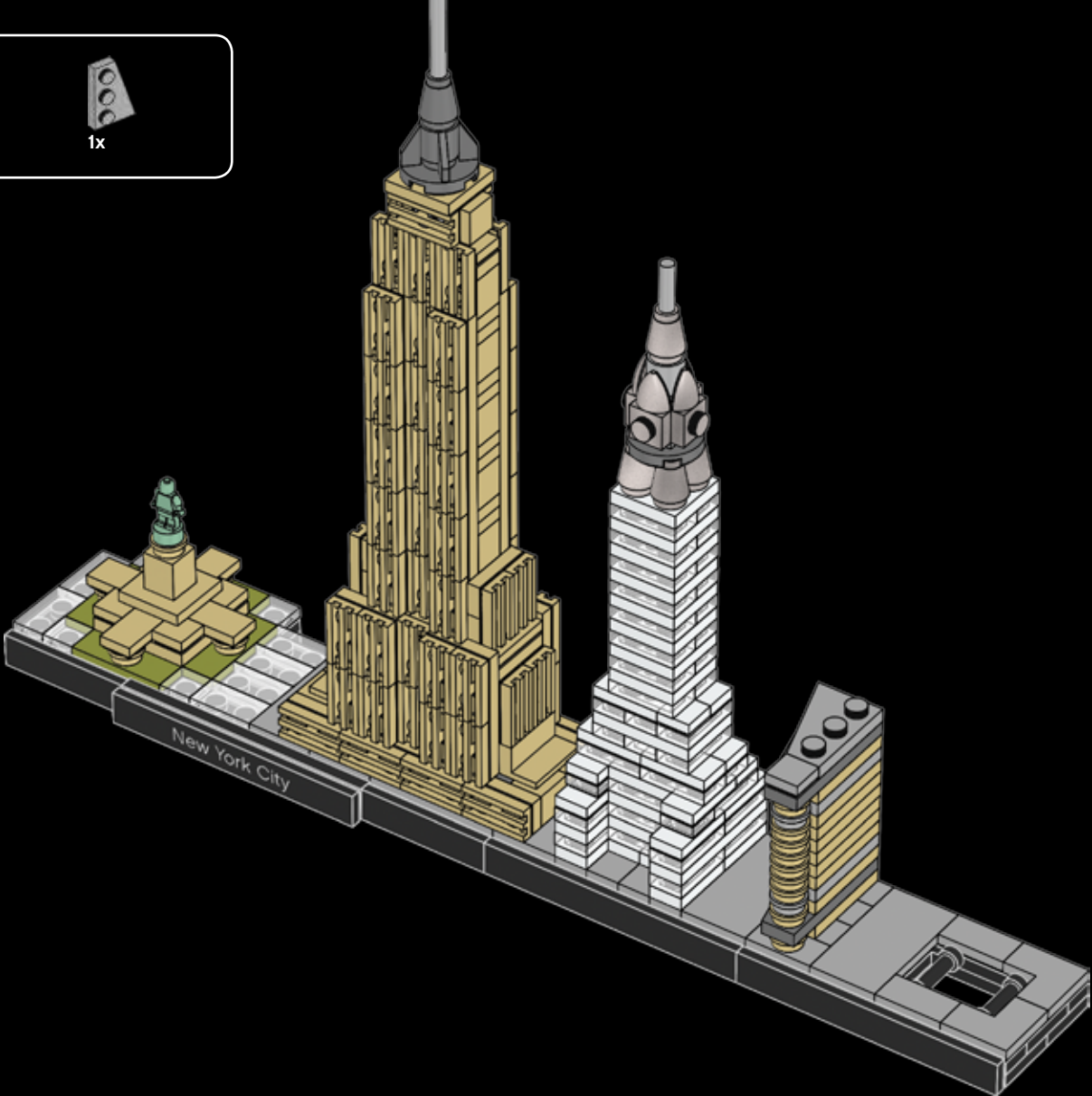

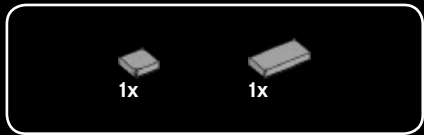

70

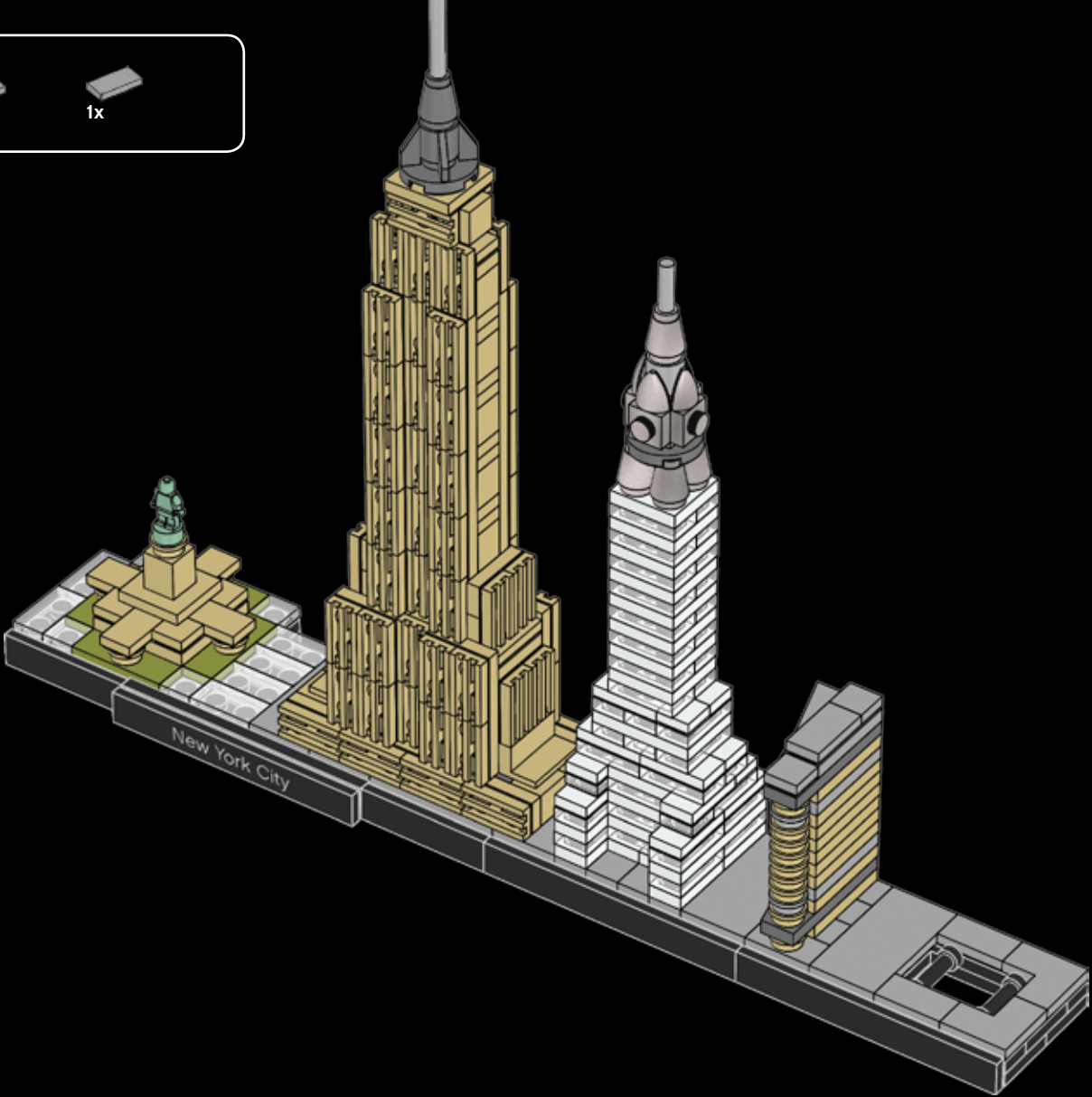



4x



4x



4x



4x



4x

1

1



2



3



4



5



6

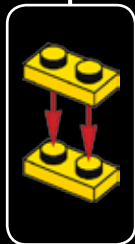

1

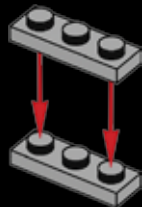

2



3



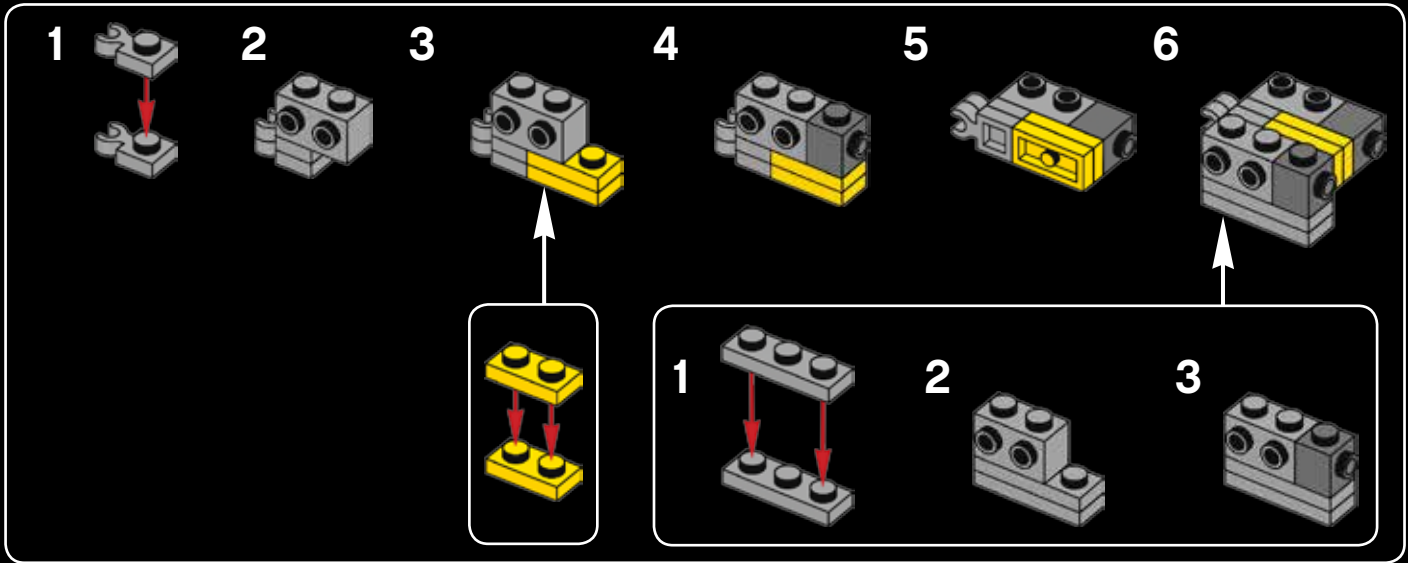



2x

9

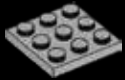

1x

10



1x

11

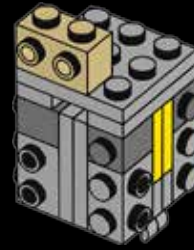

3x

12

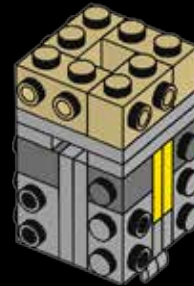

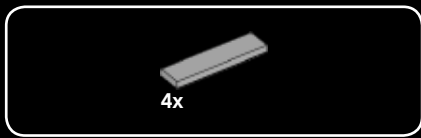

13

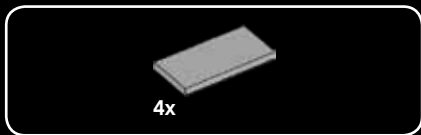
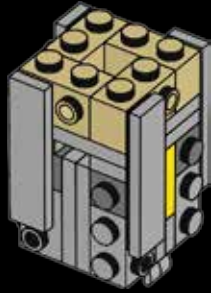

14



15

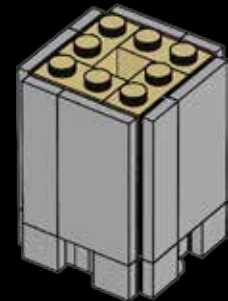

71

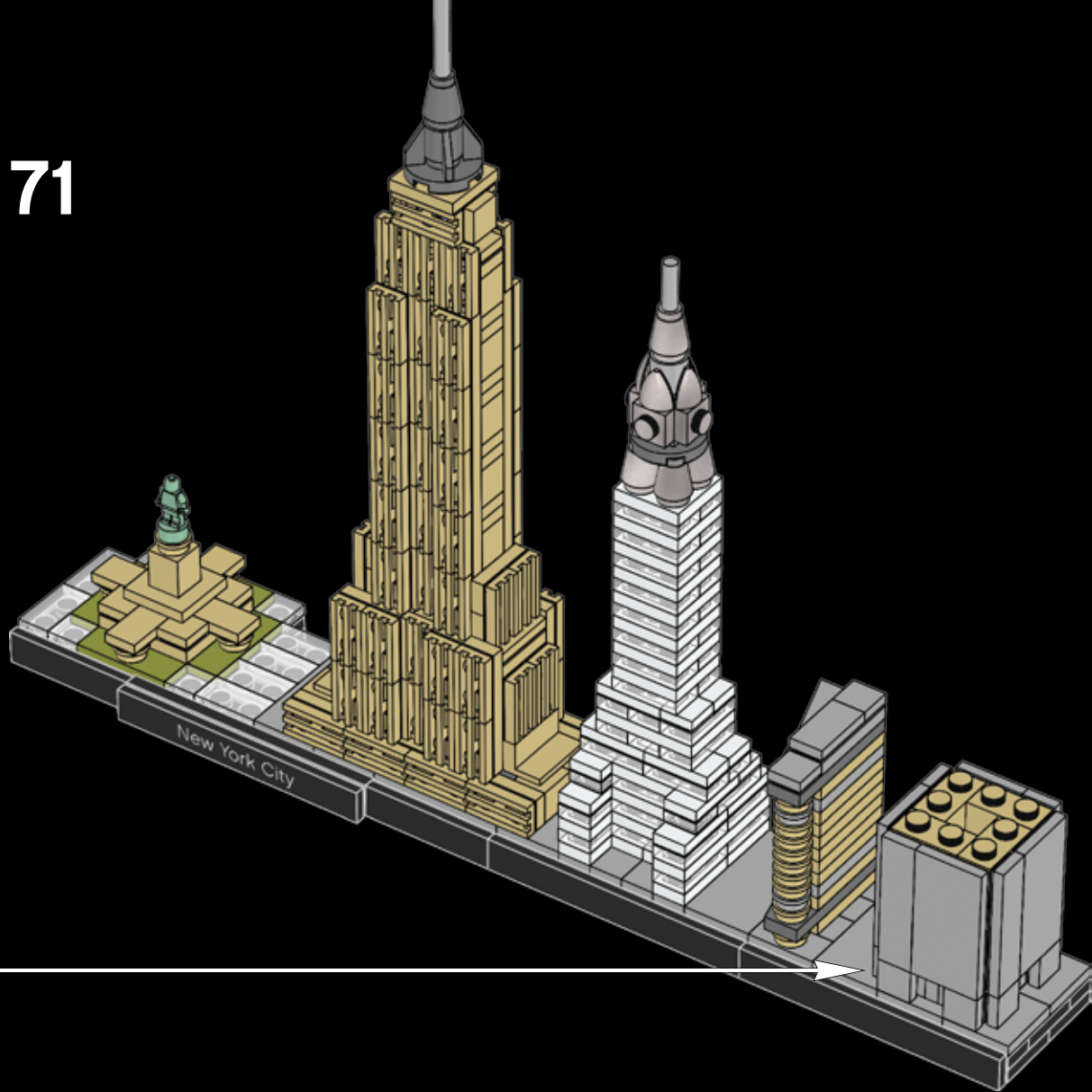

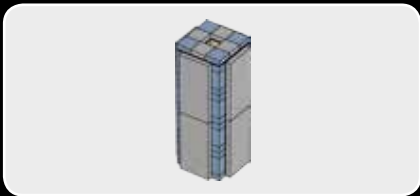

1



2

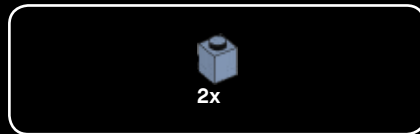

3

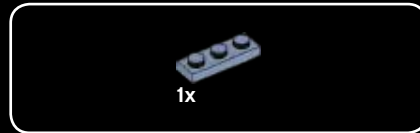

4



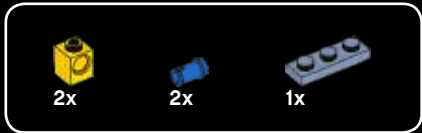

5

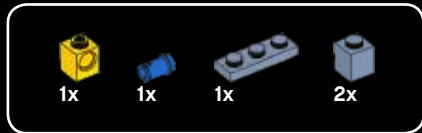
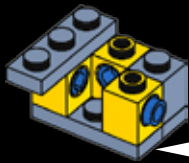
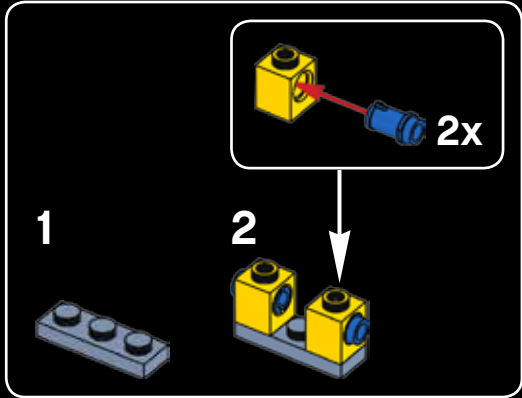

6

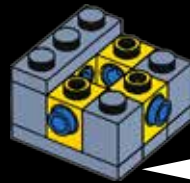
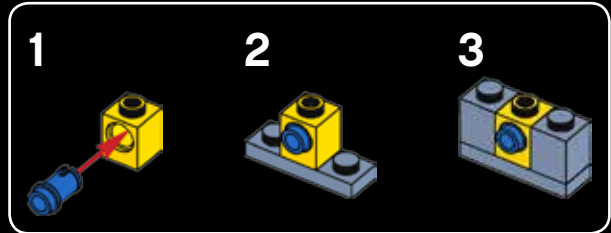



7



8

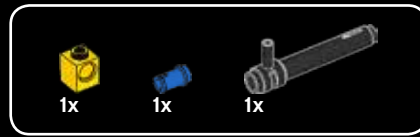
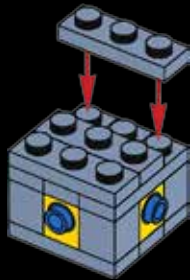

9

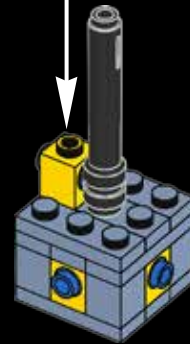
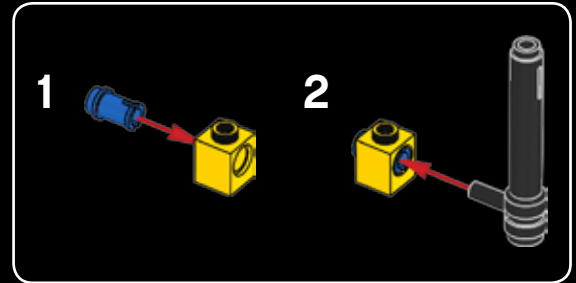



3x



3x

10

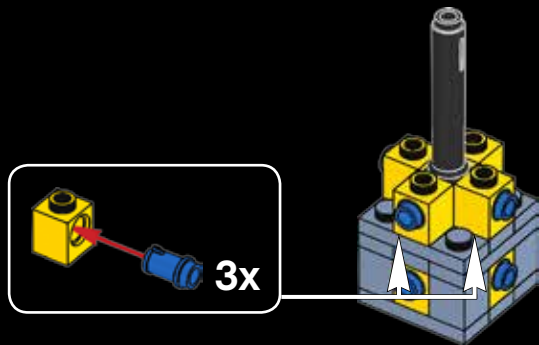

2x



2x

12



4x

11



2x



2x

13





14

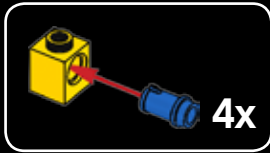

4x

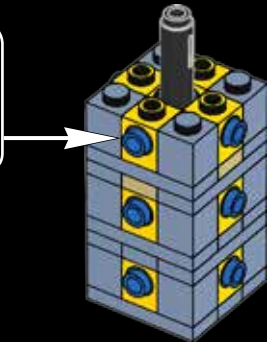

15

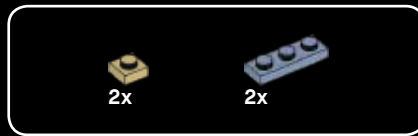

16

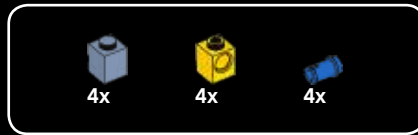

17

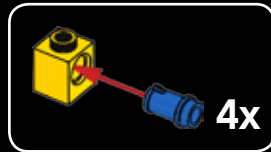

4x

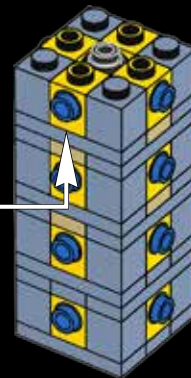



2x



2x

18

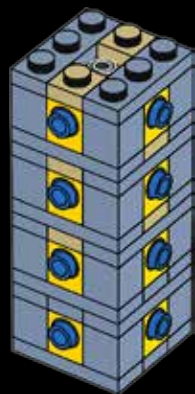

4x



4x

19

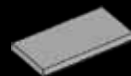

8x

20

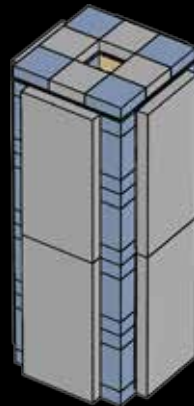

72

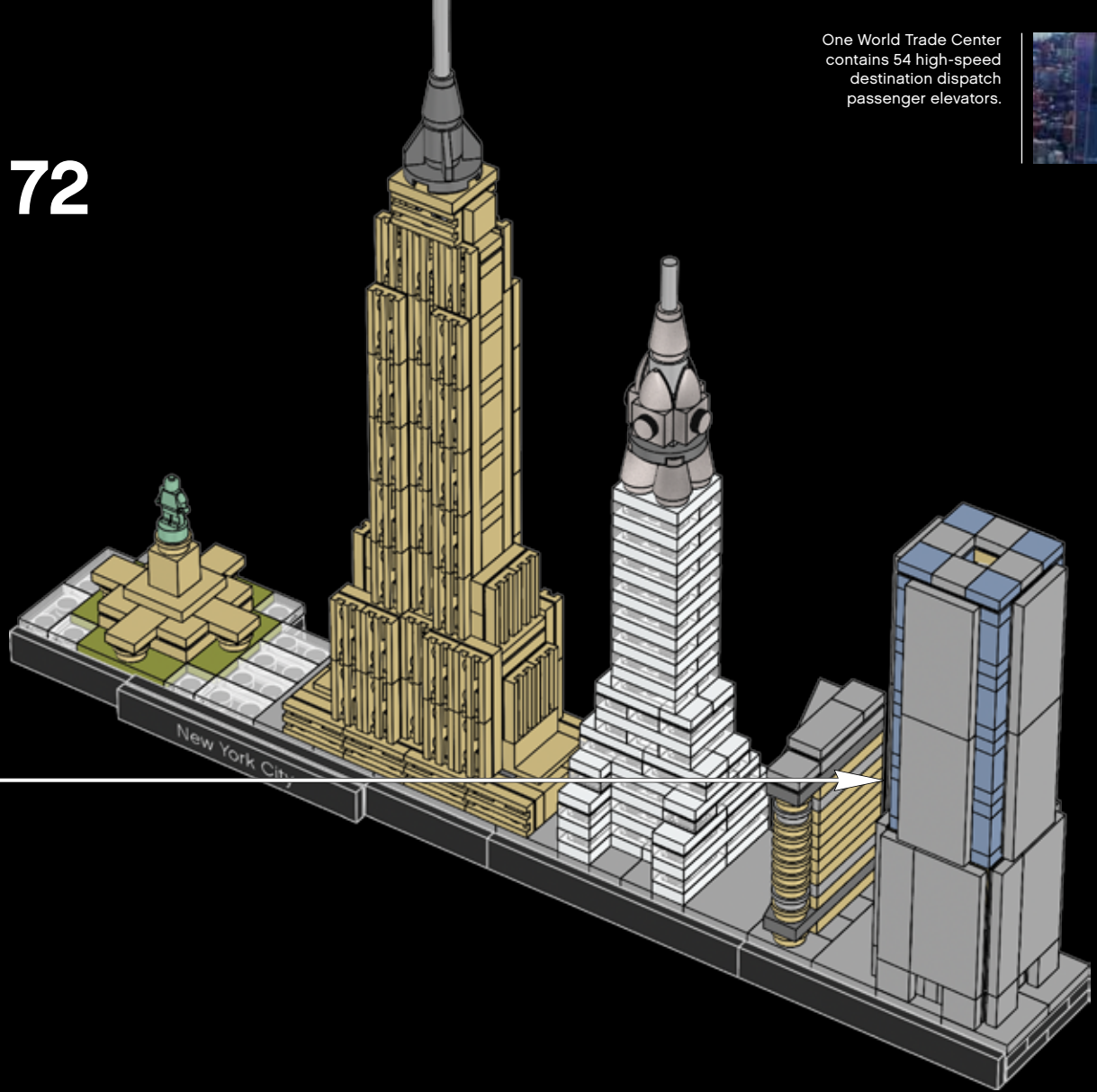

One World Trade Center contains 54 high-speed destination dispatch passenger elevators.



© One World Trade Center

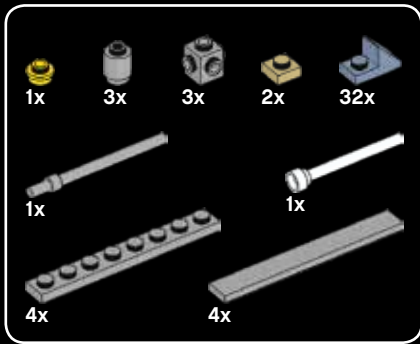

73

1



2



3



4



5



6



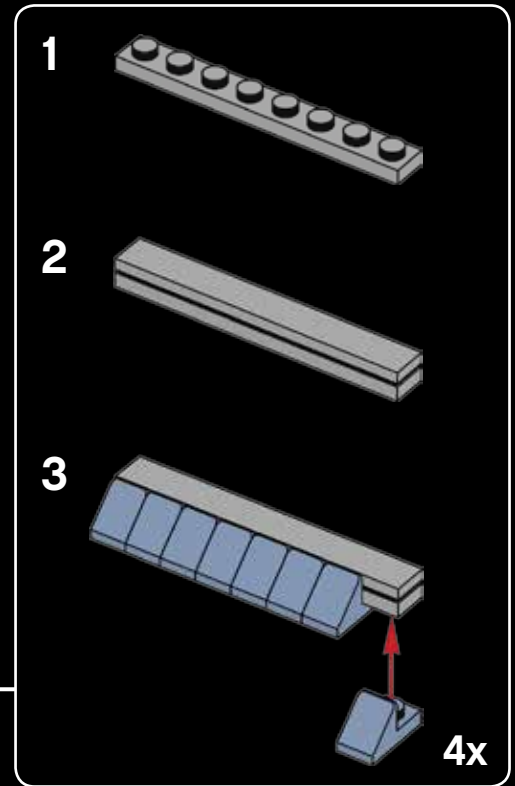
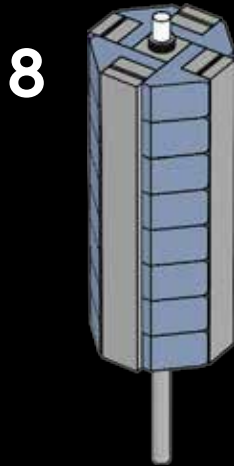
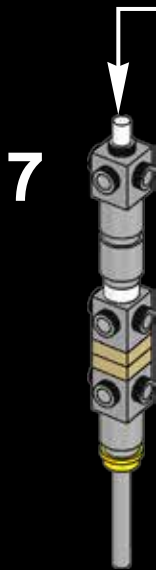
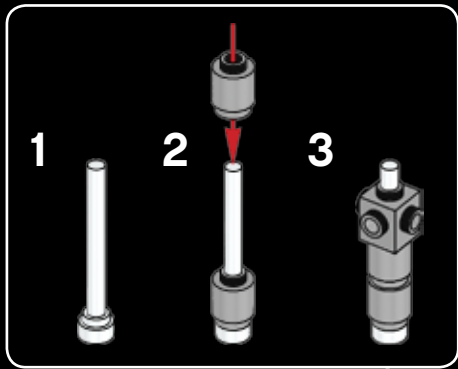

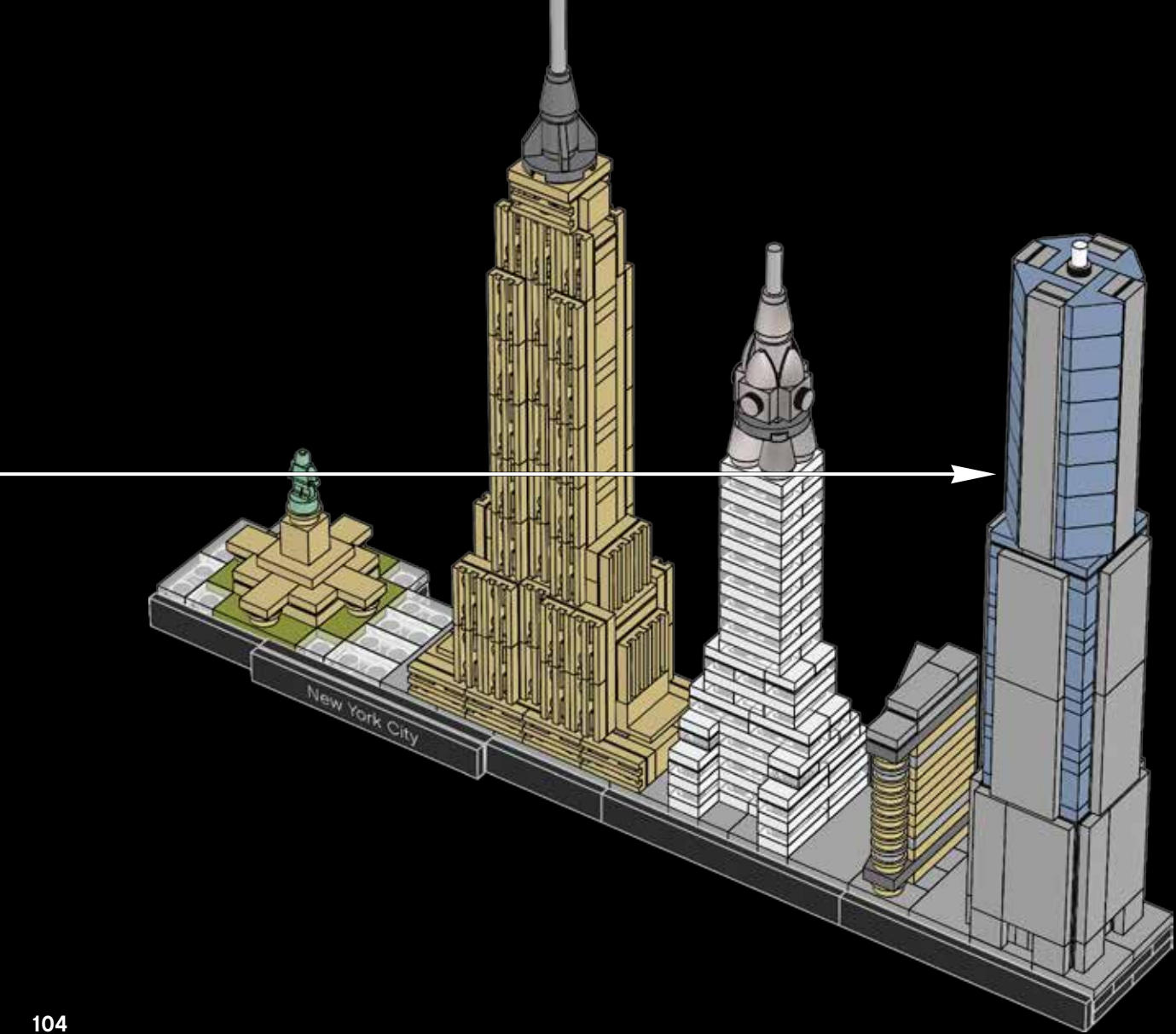

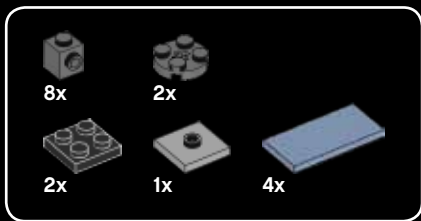

74

1



2



3

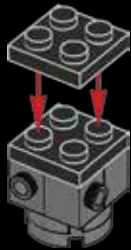

4



5



6



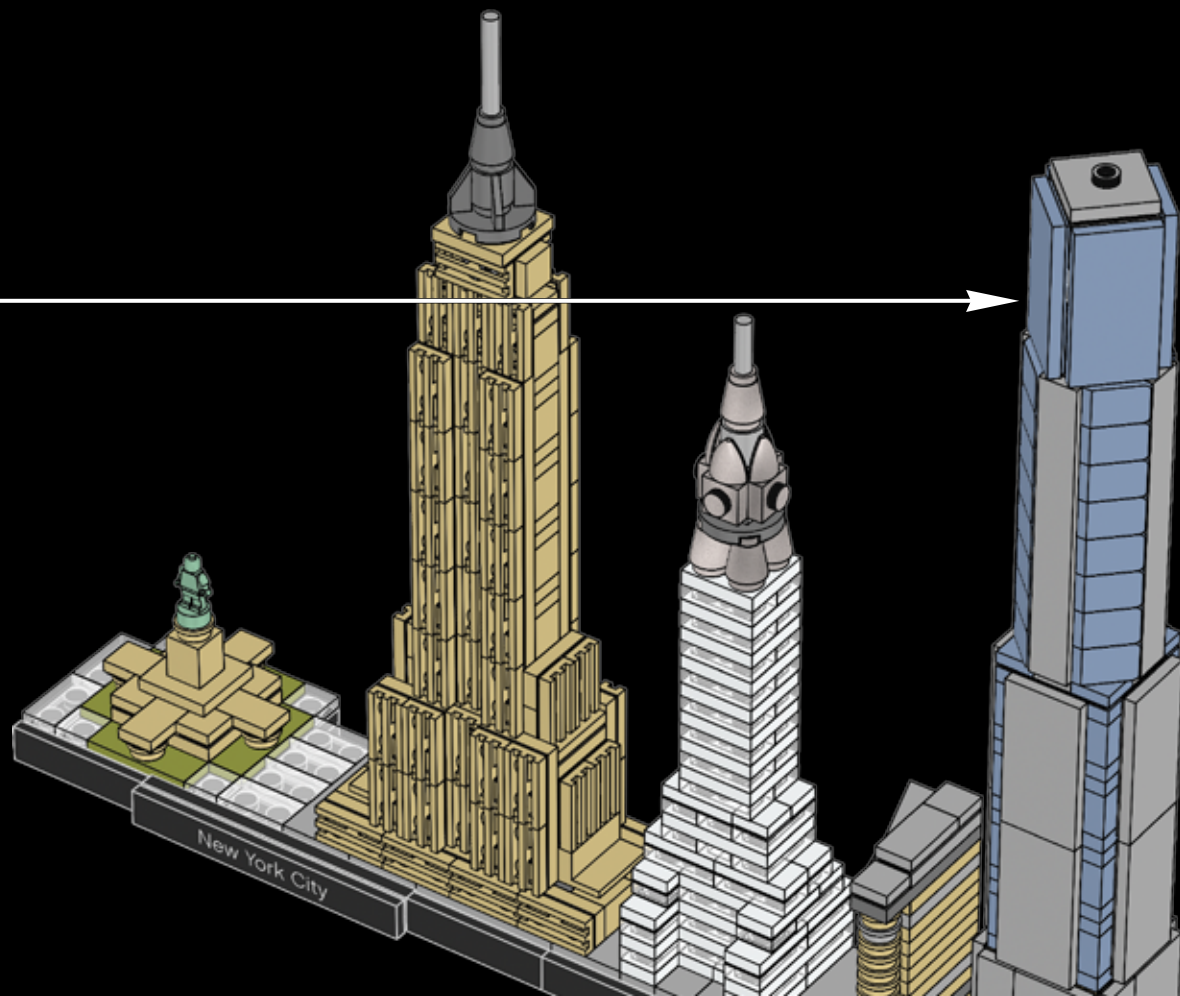

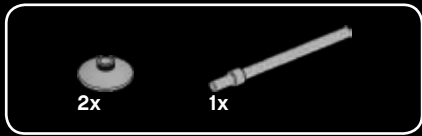

75

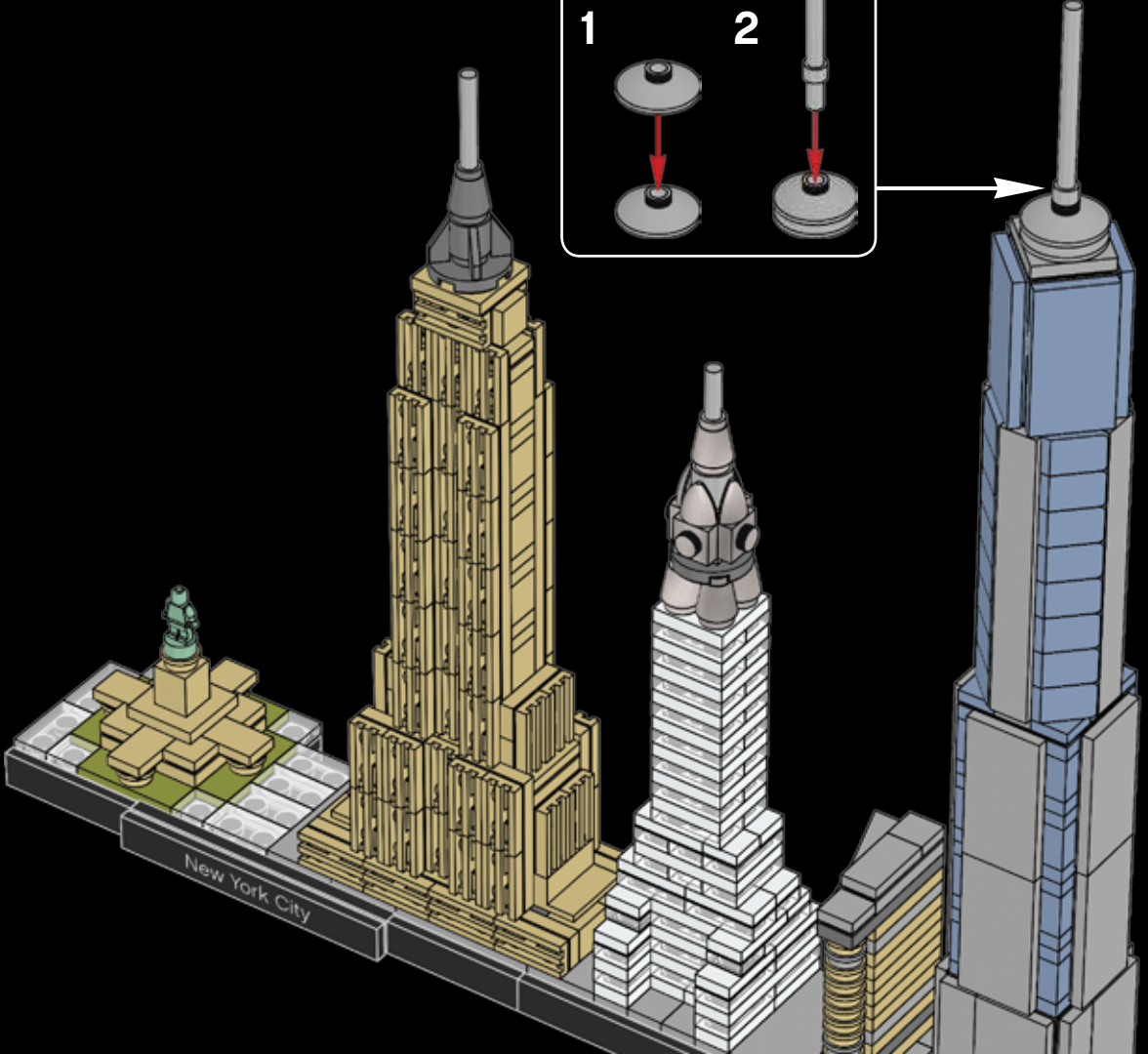
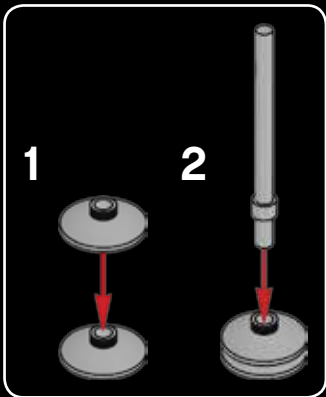





RAISING A BABY IN
AN NYC APARTMENT
IS LIKE GROWING
AN OAK TREE IN A
THIMBLE. Available in select areas. See us at 212-434-3434

LEGO® Architecture—then and now

There has always been a natural connection between the LEGO® brick and the world of architecture. Fans who build with LEGO elements instinctively develop an interest in the form and function of the structures they create. At the same time, many architects have discovered that LEGO bricks are the perfect way of physically expressing their creative ideas.

This connection was confirmed in the early 1960s with the launch of the LEGO 'Scale Model' line. It matched the spirit of the age where modern architects were redefining how houses look and people were taking an active interest in the design of their new homes. These sets were designed to be different from the normal, brightly colored LEGO boxes; they also included a book on architecture as a source of inspiration.

Decades later, architect and LEGO fan Adam Reed Tucker revived the idea of expressing architecture using LEGO bricks and in partnership with the LEGO

Group, launched the LEGO Architecture line that we know today. His first models, and the original sets in the current LEGO Architecture series, were interpretations of famous skyscrapers from his hometown of Chicago. Since then LEGO Architecture has developed and evolved, first with well-known buildings from other cities in the United States, and now with iconic structures from Europe, the Middle East and Asia.

The introduction of our LEGO Architecture Studio set echoes the ambitions of the earlier LEGO 'Scale Model' line and widens the potential of the LEGO Architecture series. Now you can enjoy building and learning about specific landmark buildings, or create exciting architectural models from your own fantasy. An inspiring 270-page book, featuring a number of renowned architects from around the world, guides you through the principles of architecture and encourages you in your own creative building.



21050
Studio

Celebrate the world of architecture

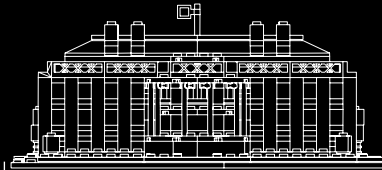

21006
The White House

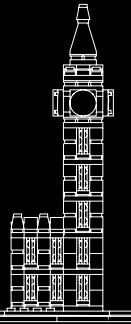

21013
Big Ben

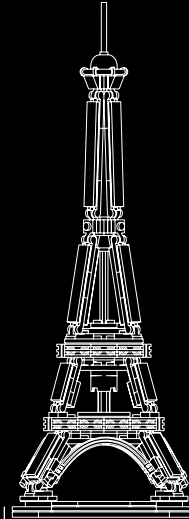

21019
The Eiffel Tower

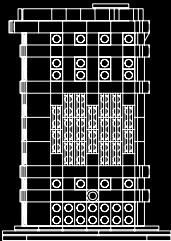

21023
Flatiron Building



21024
Louvre

and collect all the models



21020
Trevi Fountain

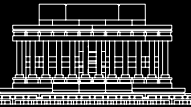

21022
Lincoln Memorial



21027
Berlin

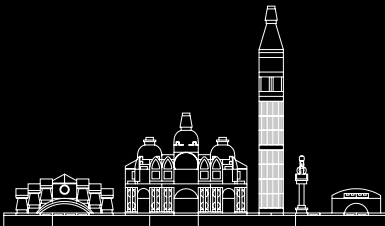

21026
Venice

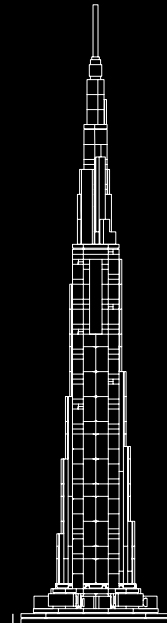

21031
Burj Khalifa

References

Photo Credits -

© Shutterstock

© Chrysler Building

© Empire State Realty Trust, Inc.

© Everett Historical

Text -

www.nycgo.com

www.wtc.com

www.esbnyc.com

www.nps.gov

www.flatirondistrict.nyc

Customer Service
Kundenservice
Service Consommateurs
Servicio Al Consumidor
LEGO.com/service or dial



00800 5346 5555 :



1-800-422-5346 :



6x 4558952
4x 307001
12x 6051511
4x 242001
12x 302201
1x 302101
2x 371001
1x 395701
14x 4161734
22x 4159553
5x 4113915
8x 4125253
16x 4213568
9x 6138230

74x 4124456
6x 4114026
3x 6092587
2x 4124460
12x 6024495
4x 4113917
2x 4565387
3x 4114084
11x 4121921
5x 4118790
4x 4114309
2x 4114324

4x 4143409
16x 4143005
1x 6050850
16x 654124
4x 302324
2x 302426
7x 302326
2x 4225201
3x 302226
2x 242026
1x 6052126
2x 362326
2x 243126

2x 371026
1x 302026
1x 4569407
4x 4653049
2x 416226
4x 346026
1x 6135412
3x 303426
6x 6047501

42x 4167842
6x 4569297
4x 6138232
16x 4620077
32x 6139519
19x 6142245
4x 6124349
1x 6138781
4x 4211412
2x 4211525
14x 4211415
5x 4211511
4x 4594238
3x 4211791

4x 4657459
2x 4211512
10x 6066097
5x 4211414
1x 6126082
2x 6065824
6x 4211429
2x 6116608
8x 4211356
2x 4211445
1x 6015347
16x 4560183
2x 6081975

1x 4211452
4x 4211481
4x 4211425
1x 4529240
12x 4558955
1x 4212352
2x 4210782
2x 4211042
2x 6115080
6x 6000606
5x 6121350
4x 4625146

4x 6046903
1x 4654448
2x 6001494

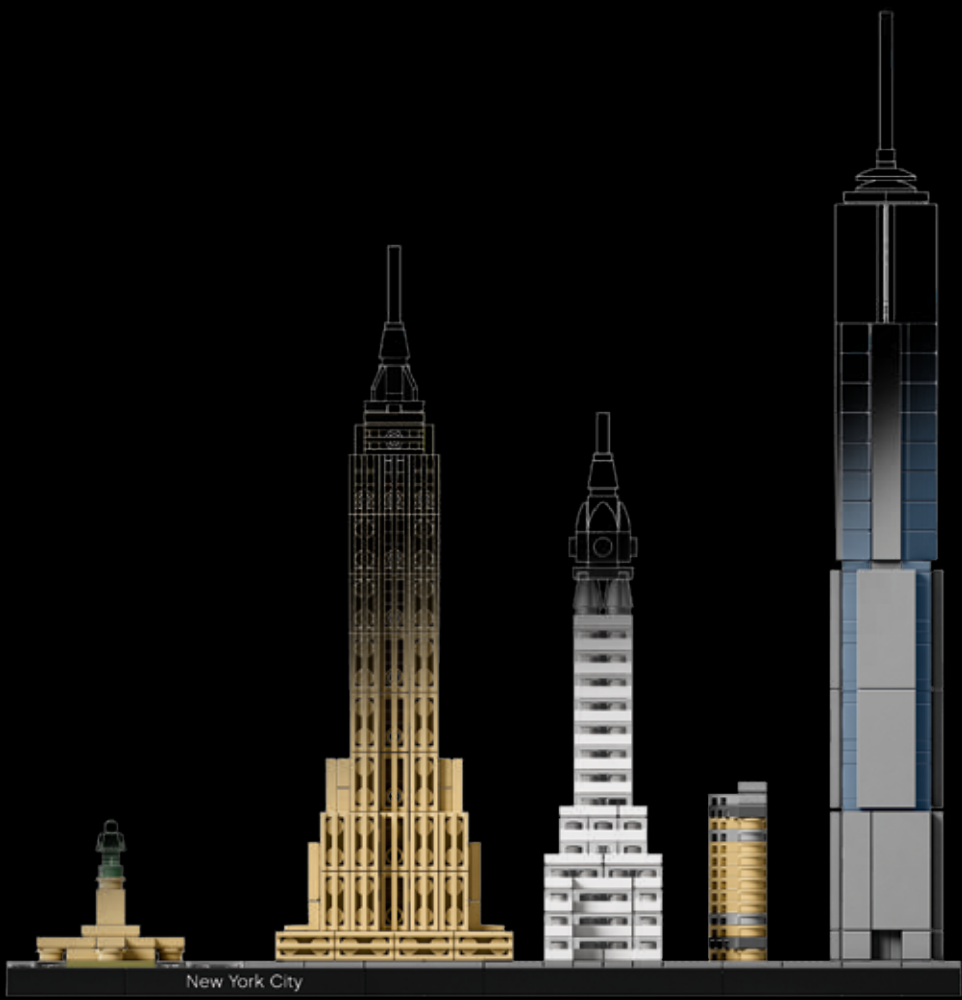

LEGO and the LEGO logo are trademarks of the LEGO Group.
©2016 The LEGO Group. 6152280

One World Trade Center building design is a copyright of WTC Tower 1 LLC.
Used under license.

The Empire State Building image® is a registered trademark of ESRT Empire State Building, L.L.C. and is used with permission.

