



ritel

Drehknopf-Programm



RITEL-Knöpfe zeichnen sich durch Formschönheit, Griffigkeit, hohe Haltbarkeit und ein umfangreiches, farbiges Zubehörprogramm aus.

RITEL-Drehknöpfe besitzen vorgespannte Spannzangen! Die Schrauben müssen vor der Montage nicht mehr gelöst werden, nur noch aufstecken und anziehen.

Les boutons RITEL se caractérisent par leur présentation soignée, leur grande solidité, l'excellent maintien sur l'axe par fixation à pince de serrage et par un programme complet d'accessoires de couleurs variées.

Les boutons RITEL sont équipés de pinces de serrage à ressort! Il n'est nécessaire de desserrer aucune vis avant le montage, simplement enfoncer et serrer.

RITEL knobs are distinguished by their styling elegance, easy handling, long service life, excellent fit on the shaft as a result of clamping chuck mounting and by their comprehensive accessories program in different colours.

RITEL knobs have preloaded collets! No screws have to be loosened before fitting, push on and tighten only.



Die RITEL-Drehknöpfe sind in den Ausführungen «standard» und «mat finish» in vier Farben ab Lager lieferbar. Für die Deckel und Pfeile haben wir noch drei zusätzliche Farben ausgewählt. Alle Teile sind auch in Spezialfarben erhältlich.

Tous les modèles de boutons RITEL sont livrables en exécution «standard» et «mat finish» en quatre couleurs. Les capuchons et les disques à flèche existent en trois couleurs supplémentaires. Tous nos boutons et accessoires sont aussi à disposition en couleurs spéciales.

RITEL collet knobs are available in «standard» and «mat finish» in four colours. We have selected three additional colours for caps and arrows. All knobs and accessories are also at your disposal in a large range of special colours.

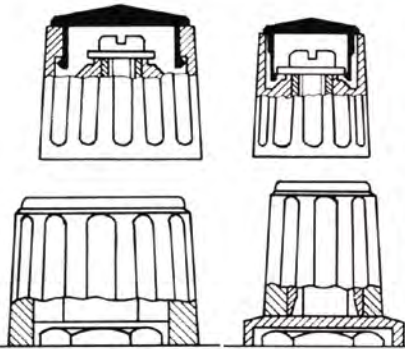

Die Deckel sind in drei Grundausführungen lieferbar: flach, Prismaform und bombiert. Die flachen Deckel mit zusätzlich aufgeprägtem Strich, Pfeil, Schwellpfeil oder mit eingelegter Aluminiumscheibe; die Prismadeckel mit aufgeprägtem Punkt; die bombierten Deckel mit Strich. Die Deckel sind so konstruiert, dass sie bei der Montage im Knopf einrasten und dadurch unverlierbar sind.

Les capuchons sont livrables en trois exécutions de base: Modèle plat, forme prismatique et forme courbée. Les capuchons plats sont aussi fabriqués avec des repères: trait, flèche, flèche courbée ou avec disque aluminium; les capuchons prismatiques avec point; les capuchons courbés avec trait. Les capuchons sont munis d'un encliquetage qui se verrouille dans le bouton lors du montage.

Caps are sold in three basic models: flat, prismatic or curved. The flat cap can also be furnished with indicator line, arrow, curved arrow or with aluminium disk, the prismatic cap with distinctive point and the curved cap with indicator line. Caps snap into a secure position in the knob.

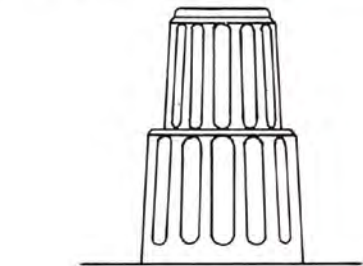

Die Knopfgrößen 21 mm, 28 mm, 36 mm und 45 mm besitzen Aussparungen für Befestigungsmuttern, für 10 mm, 13 mm und 15 mm gibt es Mutterabdeckungen.

Les boutons de diamètre 21 mm, 28 mm, 36 mm et 45 mm possèdent un dégagement pour l'écrou. Ils existent des jupes pour les diamètres de 10, 13 et de 15 mm.

The 21 mm, 28 mm, 36 mm and 45 mm knob sizes have recesses for nuts. For the 10, 13 and 15 mm sizes nut covers are available.

Drehknöpfe mit durchgehender Spannzange für Doppelknöpfe sind ebenfalls lieferbar. Nähere Angaben finden Sie auf den Seiten 30 und 31.

Les boutons doubles avec pince de serrage pour axes coaxiaux sont aussi livrables, vous trouverez les détails aux pages 30 et 31.

Knobs with coaxial collet for double knobs are also available. Detailed information on pages 30 and 31.

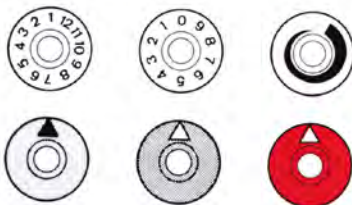

Eine grosse Anzahl von Zahlscheiben für Rastereinstellungen 27°40', 30°, 36° und 60°, sowie farbige Scheiben ersparen Ihnen teure Sonderanfertigungen.

Le grand choix de cadrans gravés pour angles de positionnement de 27°40', 30°, 36° et 60° vous évite la réalisation de platines frontales coûteuses.

A large selection of figure dials for indexing angles of 27°40', 30°, 36° and 60° together with coloured disks dispense with the need for expensive manufacture of special units.



Die in acht Farben lieferbaren RITEL-Industrieklemmen sind eine Ergänzung zum RITEL-Drehknopfprogramm.

Les pinces industrielles RITEL, livrables en huit couleurs, constituent une extension du programme de boutons RITEL.

The RITEL industrial terminal, available in eight colours, is a supplement to the RITEL range of knobs.

Vielleicht finden Sie trotz des umfangreichen Sortiments «Ihren» Knopf nicht in unserem Programm. Wir sind gerne bereit, Ihnen Spezialknöpfe oder Zubehörteile nach Ihren Zeichnungen oder Ihren Mustern zu offerieren.

Si malgré la grande étendue de notre assortiment vous ne trouvez pas «Votre» bouton dans notre programme, nous vous offrirons volontiers une exécution spéciale conforme à vos dessins ou échantillons.

If you did not find «your» particular knob in our vast collection, please do not hesitate to contact us. We shall be pleased to offer you special knobs and accessories to your specifications.

Knopf
Bouton
Knob

8 mm



10 mm



13 mm



15 mm



21 mm



28 mm



36 mm



45 mm



Knebelknopf
Bouton à oreilles
Wing knob

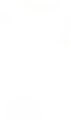

Pfeilknopf
Bouton à flèche
Arrow knob



Inhalt

Einführung
Drehmomente
Spez. Zubehör
Knopf, Deckel

Statoren
Zahlscheiben
Pfeilscheiben
Pfeile
Mutterabd.
Kurzknöpfe

Knöpfe mit durchgehender Spann.
Doppelknöpfe
Zwischendeckel
Steckknöpfe
Industrieklemmen
Industrieklemmen berührungssicher

Introduction
Couples
Accessoires spéciaux
Bouton, couvercle

Stators
Cadrans
Disques à flèche
Flèches
Couvre-écrous
Boutons courts

Boutons avec pince de serrage
traversante
Boutons doubles
Couvercles intermédiaires
Boutons embrochables
Bornes industrielles
Bornes industrielles protégées
contre le toucher

Introduction
Torques
Spec. accessories
Knob, cover

Stators
Number wheels
Arrow plates
Arrows
Nut cover
Short knobs

Knobs with continuous collet
Double knobs
Intermediate cover
Push-on knobs
Industrial terminals
Industrial terminals shockproof

Seite

2, 3, 4, 5
5
6
7

8, 9
10, 11
12, 13
14, 15
16, 17
18, 19
20, 21

26, 27
26, 27
26, 27
28
29
15, 22, 23
21, 24, 25, 26
28, 24, 25, 26
36, 24, 25, 26

30
31
31
32, 33
34
35

2, 3, 4, 5
5
6
7

8, 9
10, 11
12, 13
14, 15
16, 17
18, 19
20, 21
45

26, 27
26, 27
26, 27
28
29
15, 22, 23
21, 24, 25, 26
28, 24, 25, 26
36, 24, 25, 26

30
31
31
32, 33
34
35

2, 3, 4, 5
5
6
7

8, 9
10, 11
12, 13
14, 15
16, 17
18, 19
20, 21
45

26, 27
26, 27
26, 27
28
29
15, 22, 23
21, 24, 25, 26
28, 24, 25, 26
36, 24, 25, 26

30
31
31
32, 33
34
35

Kurzknopf

Bouton court
Short knob

15 mm



21 mm



28 mm



36 mm



Material

Für das Programm «standard» und «mat finish» verwenden wir Polyamid.
Für die transparenten Zahlenscheiben wird PC verwendet. Für Spannzangen, Spannhülsen und Muttern verwenden wir Messing 58. Schrauben und Unterlagscheiben sind aus Stahl promatisiert.

Temperaturbeständigkeit

Bei normaler mechanischer Belastung:
-20° bis +70° C.

Kurznebelknopf

Bouton court à oreilles
Short wing knob

15 mm



21 mm



28 mm



36 mm



Matériel

Tous les types du programme «standard» et «mat finish» sont en Polyamid.
Les cadrans transparents sont en PC. Les pinces de serrages, leurs douilles et leurs écrous sont en laiton MS 58. La surface des vis et rondelles est protégée contre la corrosion.

Stabilité de température

Pour des exigences mécaniques normales:
-20° à +70° C.

Das RITEL-Kurzknopfprogramm

Der RITEL-Kurzknopf ist um 20% kürzer und an das bestehende Knopfprogramm angepasst. Es ist besonders für den modernen Gerätebau geeignet. Sämtliche Spannzangen dieser Knöpfe haben Bohrungen für durchgehende Achsen. Die Montage erfolgt mit einem handelsüblichen 6 kt. Steckschlüssel.

La gamme RITEL des boutons courts

Le bouton court RITEL présente une longueur réduite de 20% et est assimilé au programme existant. Il est particulièrement adapté aux besoins de la construction d'appareils modernes. L'ensemble des pinces de serrage de ces boutons comporte des ouvertures destinées au montage coaxial. L'assemblage est fait à l'aide d'une clé à tube à six pans couramment trouvée dans le commerce.

The RITEL short-knob program

The RITEL short knob has a length reduced by about 20%. It is adapted to the existing knob program. It is particularly appropriate for the necessities of modern instrument construction. All collets of these knobs have drill holes for coaxial mounting. Mounting is done with a commercial, hexagonal box spanner.

Material

Polyamide is used for the «standard» and «mat finish» program.
The transparent dials are made of PC. Brass 58 is used for the collets, sleeves and nuts. The surface of screws and washers is protected against corrosion.
PC = Polycarbonat

Temperature stability

For normal mechanical stress:
-20° to +70° C.

Free-Drive-Schrauben

RITEL-Drehknöpfe werden mit Free-Drive-Schrauben montiert. Diese Schrauben sind eine Kombination zwischen Schrauben mit normalem Schlitz und den Philips-Kreuzschlitzschrauben. Die Free-Drive-Schrauben können somit wahlweise mit einem Kreuzschlitz- oder normalen Schraubenzieher festgezogen werden.

Vis free-drive

Les boutons RITEL sont montés avec des vis free-drive. Ces vis représentent une combinaison entre les vis à fente ordinaire et les vis à fente en croix Philips. Les vis free-drive peuvent être serrées selon le choix à l'aide d'un tournevis à 4 pans ou d'un tournevis ordinaire.

Free-drive screws

RITEL knobs are mounted with free-drive screws. These screws are the combination or ordinary one-slot screws and the Philips cross-slot screws. The free-drive screws can be tightened optionally using a screwdriver for Philips screws or an ordinary screwdriver.

RITEL-Drehknöpfe haben vorgespannte Spann-
zangen!
Die Schrauben müssen vor der Montage nicht
mehr gelöst werden, nur noch aufstecken und an-
ziehen.

Les boutons RITEL sont équipés de pinces de
serrage à ressort!
Il n'est nécessaire de desserrer aucune vis avant le
montage, simplement enfoncer et serrer.

RITEL knobs have preloaded collets! No screws
have to be loosened before fitting, push on and
tighten only.

Lieferbare Spann- zangen

Pinces de serrage livrables
Collets available

Knopf Spann- zange, vorgespannt

Bouton
Knob

durchgehend, nicht vorgespannt
traversant, sans précontrainte
coaxial, not preloaded

	2	3	1/8	4	5	5,2	6	1/4	8	10	3	1/8	4	6	1/4
8	×	×	×	×											
10	×	×	×	×											
13	×	×	×	×			×	×			×	×	×	×	×
15	×	×	×	×	×	×	×	×			×	×	×	×	×
21		×	×	×	×	×	×	×			×	×	×	×	×
28		×	×	×	×	×	×	×	×	×	×	×	×	×	×
36		×	×	×	×	×	×	×	×	×	×	×	×	×	×
45		×	×	×	×	×	×	×	×	×	×	×	×	×	×

Die mit ×* bezeichneten Spann-
zangen sind nur in kleineren Stückzahlen vorrätig, bei grösserem Bedarf bitte Termin anfragen.

Les pinces de serrage marquées d'un × ne sont en stock qu'en nombre limité. En cas de besoins importants, prière de demander le délai de livraison.

The collets marked with ×* are only stocked in small quantities. Enquire for delivery date in the case of large orders.

Drehmoment

Couple
Torque

Spannzange Pince de serrage Collet	Knopf Bouton Knob	Montage-Drehmoment Couple de fixation Assembly torque	Funktions-Drehmoment Couple de fonctionnement Operation torque
ø	ø	cNm	cNm
3, 1/8", 4	8-10	30	30
3, 1/8", 4	13-45	80	60
6, 1/4"	13-45	180	160
8	28-45	300	200
10	28-45	350	250

Die angegebenen Funktions-Drehmomente beziehen sich auf handelsübliche Stahlachsen H8.

BITTE BEACHTEN: Beim Einsatz von Spann-
zangen-Knöpfen auf Kunststoffachsen sind Versuche vorzunehmen. RITEL AG übernimmt keine Garantie
bei dieser Anwendungsart. Kunststoffachsen neigen zu Kaltfluss.

Les couples de fonctionnement indiqués se rapportent à des axes usuels en acier H8.

PRIÈRE DE REMARQUER: dans le cas d'utilisation de boutons de pinces de serrage sur des axes en plastique, il faut réaliser des essais. RITEL SA ne
supporte aucune garantie dans ce genre d'utilisation. Les axes en plastique ont tendance à fluer.

The stated operation torques refer to standard steel spindles H8.

PLEASE NOTE: Trials must be carried out when using collet knobs on plastic spindles. No guarantee is given by RITEL AG for this application method.
Plastic spindles have a tendency to cold flow.

Steckschlüssel – Clé – Box spanner



49 15 00 0

Schlitzmutter – Ecrou rond – Slotted nut

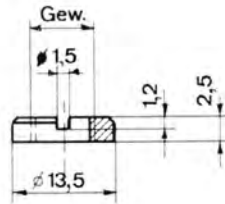

Gewinde	M 10×0,75	49 15 10 0
Filetage	3/8–32	49 15 95 0
Thread		

Verdrehungsschutz – Dispositif antirotatoire – locking-device

Verdrehungsschutz für 6 mm und ¼" Achsen (DIN 41591)
Erhältlich nur für Knöpfe Ø 21, 28, 36 und 45 mm

Dispositif antirotatoire pour axes de 6 mm et ¼" (DIN 41591)
Livrabale seulement pour boutons de 21, 28, 36 et 45 mm de Ø

Locking-device for 6 mm and ¼" axles (DIN 41591)
Available only for knobs of 21, 28, 36 and 45 mm of Ø

Der RITEL-Verdrehungsschutz für 6 mm und ¼" Achsen

Der RITEL-Verdrehungsschutz ist ein separat in den Knopf einzupressendes Stanzteil, welches dem Spannzangenknopf eine exakte Positionierung sowie ein erhöhtes Drehmoment gibt.

Erhältlich für Knöpfe Ø 21, 28, 36 und 45 mm

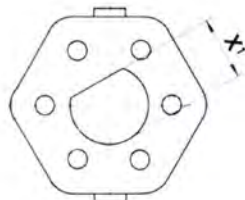

Dispositif anitrotatoire pour axes de 6 mm et de ¼"

Le dispositif antirotatoire RITEL est une pièce découpée devant être pressée séparément dans le bouton et conférant au bouton à pince de serrage un positionnement précis ainsi qu'un couple plus élevé.

Livrabale pour boutons de 21, 28, 36 et 45 mm de Ø

Locking-device for 6 mm and ¼" axles

The RITEL locking-device is a punched part to be pressed separately into the knob, allowing an accurate positioning of the collet knob and giving it an increased torque.

Available for knobs of 21, 28, 36 and 45 mm of Ø

Achsen

axes
axles x¹

6 mm	5,0	49 15 60 0
¼"	5,08	49 15 61 0

Knopf Bouton Knob

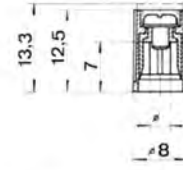

standard
mat finish

0
3
1/4"
4

3
1/4"
4

20 08 30 1	20 08 30 2	20 08 30 3	20 08 30 4
20 08 31 1	20 08 31 2	20 08 31 3	20 08 31 4
20 08 40 1	20 08 40 2	20 08 40 3	20 08 40 4
26 08 30 1	26 08 30 2	26 08 30 3	26 08 30 4
26 08 31 1	26 08 31 2	26 08 31 3	26 08 31 4
26 08 40 1	26 08 40 2	26 08 40 3	26 08 40 4

mit Strich – avec repère – with line

21 08 30 1	21 08 30 2	21 08 30 3	21 08 30 4
21 08 31 1	21 08 31 2	21 08 31 3	21 08 31 4
21 08 40 1	21 08 40 2	21 08 40 3	21 08 40 4
27 08 30 1	27 08 30 2	27 08 30 3	27 08 30 4
27 08 31 1	27 08 31 2	27 08 31 3	27 08 31 4
27 08 40 1	27 08 40 2	27 08 40 3	27 08 40 4

Knebelknopf Bouton à oreilles Wing knob

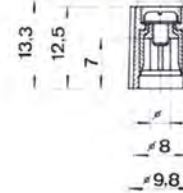

standard
mat finish

0
3
1/4"
4

3
1/4"
4

22 08 30 1	22 08 30 2	22 08 30 3	22 08 30 4
22 08 31 1	22 08 31 2	22 08 31 3	22 08 31 4
22 08 40 1	22 08 40 2	22 08 40 3	22 08 40 4
28 08 30 1	28 08 30 2	28 08 30 3	28 08 30 4
28 08 31 1	28 08 31 2	28 08 31 3	28 08 31 4
28 08 40 1	28 08 40 2	28 08 40 3	28 08 40 4

mit Strich – avec repère – with line

23 08 30 1	23 08 30 2	23 08 30 3	23 08 30 4
23 08 31 1	23 08 31 2	23 08 31 3	23 08 31 4
23 08 40 1	23 08 40 2	23 08 40 3	23 08 40 4
29 08 30 1	29 08 30 2	29 08 30 3	29 08 30 4
29 08 31 1	29 08 31 2	29 08 31 3	29 08 31 4
29 08 40 1	29 08 40 2	29 08 40 3	29 08 40 4



Deckel flach – Capuchon plat – Flat cap

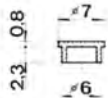

mit Strich
avec trait
with line

mit Schwellpfeil
avec flèche coudée
with curved arrow

mit Pfeil
avec flèche
with arrow

standard
mat finish

standard
mat finish

standard
mat finish

standard
mat finish

30 08 00 1	30 08 00 2	30 08 00 3	30 08 00 4	30 08 00 5	30 08 00 6	30 08 00 7
30 08 10 1	30 08 10 2	30 08 10 3	30 08 10 4	30 08 10 5	30 08 10 6	30 08 10 7
30 08 01 1	30 08 01 2	30 08 01 3	30 08 01 4	30 08 01 5	30 08 01 6	30 08 01 7
30 08 11 1	30 08 11 2	30 08 11 3	30 08 11 4	30 08 11 5	30 08 11 6	30 08 11 7
30 08 02 1	30 08 02 2	30 08 02 3	30 08 02 4	30 08 02 5	30 08 02 6	30 08 02 7
30 08 12 1	30 08 12 2	30 08 12 3	30 08 12 4	30 08 12 5	30 08 12 6	30 08 12 7
30 08 03 1	30 08 03 2	30 08 03 3	30 08 03 4	30 08 03 5	30 08 03 6	30 08 03 7
30 08 13 1	30 08 13 2	30 08 13 3	30 08 13 4	30 08 13 5	30 08 13 6	30 08 13 7

Knopf
Bouton
Knob

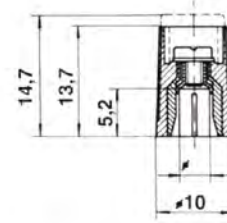

mit Strich – avec repère – with line

	φ				
standard	3				
	1/8"	20 10 30 1	20 10 30 2	20 10 30 3	20 10 30 4
	4	20 10 31 1	20 10 31 2	20 10 31 3	20 10 31 4
mat finish	3	20 10 40 1	20 10 40 2	20 10 40 3	20 10 40 4
	1/8"	26 10 30 1	26 10 30 2	26 10 30 3	26 10 30 4
	4	26 10 31 1	26 10 31 2	26 10 31 3	26 10 31 4
		26 10 40 1	26 10 40 2	26 10 40 3	26 10 40 4

21 10 30 1	21 10 30 2	21 10 30 3	21 10 30 4
21 10 31 1	21 10 31 2	21 10 31 3	21 10 31 4
21 10 40 1	21 10 40 2	21 10 40 3	21 10 40 4
27 10 30 1	27 10 30 2	27 10 30 3	27 10 30 4
27 10 31 1	27 10 31 2	27 10 31 3	27 10 31 4
27 10 40 1	27 10 40 2	27 10 40 3	27 10 40 4

Knebelknopf
Bouton à oreilles
Wing knob

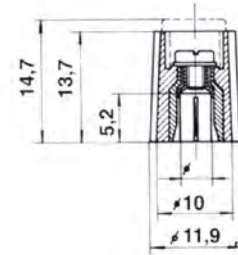

mit Strich – avec repère – with line

	φ				
standard	3				
	1/8"	22 10 30 1	22 10 30 2	22 10 30 3	22 10 30 4
	4	22 10 31 1	22 10 31 2	22 10 31 3	22 10 31 4
mat finish	3	22 10 40 1	22 10 40 2	22 10 40 3	22 10 40 4
	1/8"	28 10 30 1	28 10 30 2	28 10 30 3	28 10 30 4
	4	28 10 31 1	28 10 31 2	28 10 31 3	28 10 31 4
		28 10 40 1	28 10 40 2	28 10 40 3	28 10 40 4

23 10 30 1	23 10 30 2	23 10 30 3	23 10 30 4
23 10 31 1	23 10 31 2	23 10 31 3	23 10 31 4
23 10 40 1	23 10 40 2	23 10 40 3	23 10 40 4
29 10 30 1	29 10 30 2	29 10 30 3	29 10 30 4
29 10 31 1	29 10 31 2	29 10 31 3	29 10 31 4
29 10 40 1	29 10 40 2	29 10 40 3	29 10 40 4

Pfeilknopf
Bouton à flèche
Arrow knob

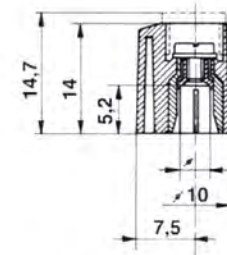

mit Strich – avec repère – with line

	φ				
standard	3				
	1/8"	18 10 30 1	18 10 30 2	18 10 30 3	18 10 30 4
	4	18 10 31 1	18 10 31 2	18 10 31 3	18 10 31 4
mat finish	3	18 10 40 1	18 10 40 2	18 10 40 3	18 10 40 4
	1/8"	16 10 30 1	16 10 30 2	16 10 30 3	16 10 30 4
	4	16 10 31 1	16 10 31 2	16 10 31 3	16 10 31 4
		16 10 40 1	16 10 40 2	16 10 40 3	16 10 40 4

19 10 30 1	19 10 30 2	19 10 30 3	19 10 30 4
19 10 31 1	19 10 31 2	19 10 31 3	19 10 31 4
19 10 40 1	19 10 40 2	19 10 40 3	19 10 40 4
17 10 30 1	17 10 30 2	17 10 30 3	17 10 30 4
17 10 31 1	17 10 31 2	17 10 31 3	17 10 31 4
17 10 40 1	17 10 40 2	17 10 40 3	17 10 40 4

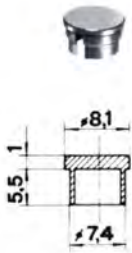

mit Strich
avec trait
with line

mit Schwellpfeil
avec flèche coudée
with curved arrow

mit Pfeil
avec flèche
with arrow

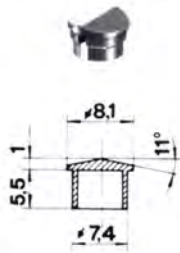

mit Punkt
avec point
with point

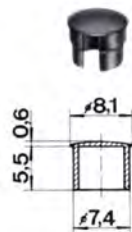

mit Strich
avec trait
with line

mit Aluminium-Scheibe
avec disque aluminium
with aluminium disk

mit Alu-Scheibe und Strich
avec disque alu et repère
with alu disk and line

Deckel flach — Capuchon plat — Flat cap

standard mat finish	30 10 00 1 30 10 10 1	30 10 00 2 30 10 10 2	30 10 00 3 30 10 10 3	30 10 00 4 30 10 10 4	30 10 00 5 30 10 10 5	30 10 00 6 30 10 10 6	30 10 00 7 30 10 10 7
standard mat finish	30 10 01 1 30 10 11 1	30 10 01 2 30 10 11 2	30 10 01 3 30 10 11 3	30 10 01 4 30 10 11 4	30 10 01 5 30 10 11 5	30 10 01 6 30 10 11 6	30 10 01 7 30 10 11 7
standard mat finish	30 10 02 1 30 10 12 1	30 10 02 2 30 10 12 2	30 10 02 3 30 10 12 3	30 10 02 4 30 10 12 4	30 10 02 5 30 10 12 5	30 10 02 6 30 10 12 6	30 10 02 7 30 10 12 7
standard mat finish	30 10 03 1 30 10 13 1	30 10 03 2 30 10 13 2	30 10 03 3 30 10 13 3	30 10 03 4 30 10 13 4	30 10 03 5 30 10 13 5	30 10 03 6 30 10 13 6	30 10 03 7 30 10 13 7

Deckel prismaform — Capuchon prismatique — Prismatic cap

standard mat finish	31 10 00 1 31 10 10 1	31 10 00 2 31 10 10 2	31 10 00 3 31 10 10 3	31 10 00 4 31 10 10 4	31 10 00 5 31 10 10 5	31 10 00 6 31 10 10 6	31 10 00 7 31 10 10 7
standard mat finish	31 10 04 1 31 10 14 1	31 10 04 2 31 10 14 2	31 10 04 3 31 10 14 3	31 10 04 4 31 10 14 4	31 10 04 5 31 10 14 5	31 10 04 6 31 10 14 6	31 10 04 7 31 10 14 7

Deckel bombiert — Capuchon courbé — Curved cap

standard mat finish	32 10 00 1 32 10 10 1	32 10 00 2 32 10 10 2	32 10 00 3 32 10 10 3	32 10 00 4 32 10 10 4	32 10 00 5 32 10 10 5	32 10 00 6 32 10 10 6	32 10 00 7 32 10 10 7
standard mat finish	32 10 01 1 32 10 11 1	32 10 01 2 32 10 11 2	32 10 01 3 32 10 11 3	32 10 01 4 32 10 11 4	32 10 01 5 32 10 11 5	32 10 01 6 32 10 11 6	32 10 01 7 32 10 11 7

Deckel flach — Capuchon plat — Flat cap

standard mat finish	35 10 00 1 35 10 10 1	35 10 00 2 35 10 10 2	35 10 00 3 35 10 10 3	35 10 00 4 35 10 10 4
standard mat finish	35 10 01 1 35 10 11 1	35 10 01 2 35 10 11 2	35 10 01 3 35 10 11 3	35 10 01 4 35 10 11 4

Knopf
Bouton
Knob

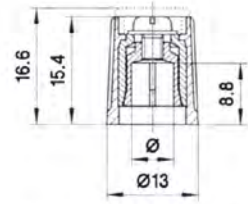

standard

0
3
1/8"
4
6
1/4"



20 13 30 1	20 13 30 2	20 13 30 3	20 13 30 4
20 13 31 1	20 13 31 2	20 13 31 3	20 13 31 4
20 13 40 1	20 13 40 2	20 13 40 3	20 13 40 4
20 13 60 1	20 13 60 2	20 13 60 3	20 13 60 4
20 13 61 1	20 13 61 2	20 13 61 3	20 13 61 4

mit Strich – avec repère – with line



21 13 30 1	21 13 30 2	21 13 30 3	21 13 30 4
21 13 31 1	21 13 31 2	21 13 31 3	21 13 31 4
21 13 40 1	21 13 40 2	21 13 40 3	21 13 40 4
21 13 60 1	21 13 60 2	21 13 60 3	21 13 60 4
21 13 61 1	21 13 61 2	21 13 61 3	21 13 61 4

Knebelknopf
Bouton à oreilles
Wing knob

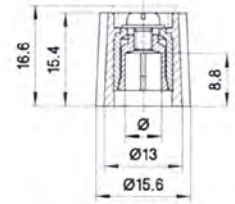

standard

0
3
1/8"
4
6
1/4"



22 13 30 1	22 13 30 2	22 13 30 3	22 13 30 4
22 13 31 1	22 13 31 2	22 13 31 3	22 13 31 4
22 13 40 1	22 13 40 2	22 13 40 3	22 13 40 4
22 13 60 1	22 13 60 2	22 13 60 3	22 13 60 4
22 13 61 1	22 13 61 2	22 13 61 3	22 13 61 4

mit Strich – avec repère – with line



23 13 30 1	23 13 30 2	23 13 30 3	23 13 30 4
23 13 31 1	23 13 31 2	23 13 31 3	23 13 31 4
23 13 40 1	23 13 40 2	23 13 40 3	23 13 40 4
23 13 60 1	23 13 60 2	23 13 60 3	23 13 60 4
23 13 61 1	23 13 61 2	23 13 61 3	23 13 61 4

13-mm-Knopf auch mit durchgehender Spannzange erhältlich. Siehe Seite 30.

Le bouton de 13 mm est aussi livrable avec pince de serrage coaxial. Voir page 30.

The 13 mm knob is also available with coaxial collet. See page 30.

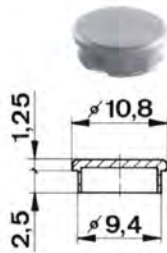

mit Strich
avec trait
with line

Deckel flach – Capuchon plat – Flat cap

standard mat finish	3013 00 1 3013 10 1	3013 00 2 3013 10 2	3013 00 3 3013 10 3	3013 00 4 3013 10 4	3013 00 5 3013 10 5	3013 00 6 3013 10 6	3013 00 7 3013 10 7

mit Schwellpfeil
avec flèche coudée
with curved arrow

standard mat finish	3013 01 1 3013 11 1	3013 01 2 3013 11 2	3013 01 3 3013 11 3	3013 01 4 3013 11 4	3013 01 5 3013 11 5	3013 01 6 3013 11 6	3013 01 7 3013 11 7

mit Pfeil
avec flèche
with arrow

standard mat finish	3013 02 1 3013 12 1	3013 02 2 3013 12 2	3013 02 3 3013 12 3	3013 02 4 3013 12 4	3013 02 5 3013 12 5	3013 02 6 3013 12 6	3013 02 7 3013 12 7

standard mat finish	3013 03 1 3013 13 1	3013 03 2 3013 13 2	3013 03 3 3013 13 3	3013 03 4 3013 13 4	3013 03 5 3013 13 5	3013 03 6 3013 13 6	3013 03 7 3013 13 7



mit Punkt
avec point
with point

Deckel prismaform – Capuchon prismatique – Prismatic cap

standard mat finish	3113 00 1 3113 10 1	3113 00 2 3113 10 2	3113 00 3 3113 10 3	3113 00 4 3113 10 4	3113 00 5 3113 10 5	3113 00 6 3113 10 6	3113 00 7 3113 10 7

standard mat finish	3113 04 1 3113 14 1	3113 04 2 3113 14 2	3113 04 3 3113 14 3	3113 04 4 3113 14 4	3113 04 5 3113 14 5	3113 04 6 3113 14 6	3113 04 7 3113 14 7



mit Strich
avec trait
with line

Deckel bombiert – Capuchon courbé – Curved cap

standard mat finish	3213 00 1 3213 10 1	3213 00 2 3213 10 2	3213 00 3 3213 10 3	3213 00 4 3213 10 4	3213 00 5 3213 10 5	3213 00 6 3213 10 6	3213 00 7 3213 10 7

standard mat finish	3213 01 1 3213 11 1	3213 01 2 3213 11 2	3213 01 3 3213 11 3	3213 01 4 3213 11 4	3213 01 5 3213 11 5	3213 01 6 3213 11 6	3213 01 7 3213 11 7

Knopf Bouton Knob

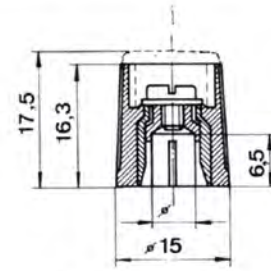

	φ				
standard	3	20 15 30 1	20 15 30 2	20 15 30 3	20 15 30 4
	1/8"	20 15 31 1	20 15 31 2	20 15 31 3	20 15 31 4
	4	20 15 40 1	20 15 40 2	20 15 40 3	20 15 40 4
	6	20 15 60 1	20 15 60 2	20 15 60 3	20 15 60 4
mat finish	1/4"	20 15 61 1	20 15 61 2	20 15 61 3	20 15 61 4
	3	26 15 30 1	26 15 30 2	26 15 30 3	26 15 30 4
	1/8"	26 15 31 1	26 15 31 2	26 15 31 3	26 15 31 4
	4	26 15 40 1	26 15 40 2	26 15 40 3	26 15 40 4
	6	26 15 60 1	26 15 60 2	26 15 60 3	26 15 60 4
	1/4"	26 15 61 1	26 15 61 2	26 15 61 3	26 15 61 4

mit Strich – avec repère – with line

	φ				
standard	3	21 15 30 1	21 15 30 2	21 15 30 3	21 15 30 4
	1/8"	21 15 31 1	21 15 31 2	21 15 31 3	21 15 31 4
	4	21 15 40 1	21 15 40 2	21 15 40 3	21 15 40 4
	6	21 15 60 1	21 15 60 2	21 15 60 3	21 15 60 4
mat finish	1/4"	21 15 61 1	21 15 61 2	21 15 61 3	21 15 61 4
	3	27 15 30 1	27 15 30 2	27 15 30 3	27 15 30 4
	1/8"	27 15 31 1	27 15 31 2	27 15 31 3	27 15 31 4
	4	27 15 40 1	27 15 40 2	27 15 40 3	27 15 40 4
	6	27 15 60 1	27 15 60 2	27 15 60 3	27 15 60 4
	1/4"	27 15 61 1	27 15 61 2	27 15 61 3	27 15 61 4

Knebelknopf Bouton à oreilles Wing knob

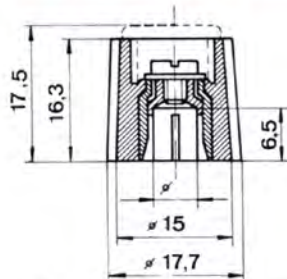

	φ				
standard	3	22 15 30 1	22 15 30 2	22 15 30 3	22 15 30 4
	1/8"	22 15 31 1	22 15 31 2	22 15 31 3	22 15 31 4
	4	22 15 40 1	22 15 40 2	22 15 40 3	22 15 40 4
	6	22 15 60 1	22 15 60 2	22 15 60 3	22 15 60 4
mat finish	1/4"	22 15 61 1	22 15 61 2	22 15 61 3	22 15 61 4
	3	28 15 30 1	28 15 30 2	28 15 30 3	28 15 30 4
	1/8"	28 15 31 1	28 15 31 2	28 15 31 3	28 15 31 4
	4	28 15 40 1	28 15 40 2	28 15 40 3	28 15 40 4
	6	28 15 60 1	28 15 60 2	28 15 60 3	28 15 60 4
	1/4"	28 15 61 1	28 15 61 2	28 15 61 3	28 15 61 4

mit Strich – avec repère – with line

	φ				
standard	3	23 15 30 1	23 15 30 2	23 15 30 3	23 15 30 4
	1/8"	23 15 31 1	23 15 31 2	23 15 31 3	23 15 31 4
	4	23 15 40 1	23 15 40 2	23 15 40 3	23 15 40 4
	6	23 15 60 1	23 15 60 2	23 15 60 3	23 15 60 4
mat finish	1/4"	23 15 61 1	23 15 61 2	23 15 61 3	23 15 61 4
	3	29 15 30 1	29 15 30 2	29 15 30 3	29 15 30 4
	1/8"	29 15 31 1	29 15 31 2	29 15 31 3	29 15 31 4
	4	29 15 40 1	29 15 40 2	29 15 40 3	29 15 40 4
	6	29 15 60 1	29 15 60 2	29 15 60 3	29 15 60 4
	1/4"	29 15 61 1	29 15 61 2	29 15 61 3	29 15 61 4

Pfeilknopf Bouton à flèche Arrow knob

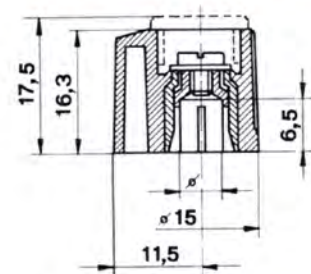

	φ				
standard	3	18 15 30 1	18 15 30 2	18 15 30 3	18 15 30 4
	1/8"	18 15 31 1	18 15 31 2	18 15 31 3	18 15 31 4
	4	18 15 40 1	18 15 40 2	18 15 40 3	18 15 40 4
	6	18 15 60 1	18 15 60 2	18 15 60 3	18 15 60 4
mat finish	1/4"	18 15 61 1	18 15 61 2	18 15 61 3	18 15 61 4
	3	16 15 30 1	16 15 30 2	16 15 30 3	16 15 30 4
	1/8"	16 15 31 1	16 15 31 2	16 15 31 3	16 15 31 4
	4	16 15 40 1	16 15 40 2	16 15 40 3	16 15 40 4
	6	16 15 60 1	16 15 60 2	16 15 60 3	16 15 60 4
	1/4"	16 15 61 1	16 15 61 2	16 15 61 3	16 15 61 4

mit Strich – avec repère – with line

	φ				
standard	3	19 15 30 1	19 15 30 2	19 15 30 3	19 15 30 4
	1/8"	19 15 31 1	19 15 31 2	19 15 31 3	19 15 31 4
	4	19 15 40 1	19 15 40 2	19 15 40 3	19 15 40 4
	6	19 15 60 1	19 15 60 2	19 15 60 3	19 15 60 4
mat finish	1/4"	19 15 61 1	19 15 61 2	19 15 61 3	19 15 61 4
	3	17 15 30 1	17 15 30 2	17 15 30 3	17 15 30 4
	1/8"	17 15 31 1	17 15 31 2	17 15 31 3	17 15 31 4
	4	17 15 40 1	17 15 40 2	17 15 40 3	17 15 40 4
	6	17 15 60 1	17 15 60 2	17 15 60 3	17 15 60 4
	1/4"	17 15 61 1	17 15 61 2	17 15 61 3	17 15 61 4

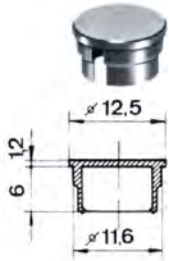

mit Strich
avec trait
with line

mit Schwellpfeil
avec flèche coudée
with curved arrow

mit Pfeil
avec flèche
with arrow

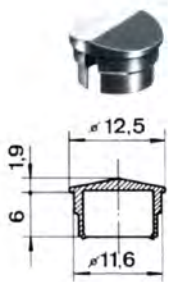

mit Punkt
avec point
with point

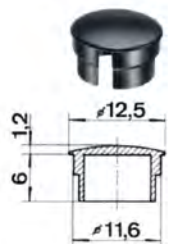

mit Strich
avec trait
with line

mit Aluminium-Scheibe
avec disque aluminium
with aluminium disk

mit Alu-Scheibe und Strich
avec disque alu et repère
with alu disk and line

Deckel flach — Capuchon plat — Flat cap

standard mat finish	30 15 00 1 30 15 10 1	30 15 00 2 30 15 10 2	30 15 00 3 30 15 10 3	30 15 00 4 30 15 10 4	30 15 00 5 30 15 10 5	30 15 00 6 30 15 10 6	30 15 00 7 30 15 10 7
standard mat finish	30 15 01 1 30 15 11 1	30 15 01 2 30 15 11 2	30 15 01 3 30 15 11 3	30 15 01 4 30 15 11 4	30 15 01 5 30 15 11 5	30 15 01 6 30 15 11 6	30 15 01 7 30 15 11 7
standard mat finish	30 15 02 1 30 15 12 1	30 15 02 2 30 15 12 2	30 15 02 3 30 15 12 3	30 15 02 4 30 15 12 4	30 15 02 5 30 15 12 5	30 15 02 6 30 15 12 6	30 15 02 7 30 15 12 7
standard mat finish	30 15 03 1 30 15 13 1	30 15 03 2 30 15 13 2	30 15 03 3 30 15 13 3	30 15 03 4 30 15 13 4	30 15 03 5 30 15 13 5	30 15 03 6 30 15 13 6	30 15 03 7 30 15 13 7

Deckel prismaform — Capuchon prismatique — Prismatic cap

standard mat finish	31 15 00 1 31 15 10 1	31 15 00 2 31 15 10 2	31 15 00 3 31 15 10 3	31 15 00 4 31 15 10 4	31 15 00 5 31 15 10 5	31 15 00 6 31 15 10 6	31 15 00 7 31 15 10 7
standard mat finish	31 15 04 1 31 15 14 1	31 15 04 2 31 15 14 2	31 15 04 3 31 15 14 3	31 15 04 4 31 15 14 4	31 15 04 5 31 15 14 5	31 15 04 6 31 15 14 6	31 15 04 7 31 15 14 7

Deckel bombiert — Capuchon courbé — Curved cap

standard mat finish	32 15 00 1 32 15 10 1	32 15 00 2 32 15 10 2	32 15 00 3 32 15 10 3	32 15 00 4 32 15 10 4	32 15 00 5 32 15 10 5	32 15 00 6 32 15 10 6	32 15 00 7 32 15 10 7
standard mat finish	32 15 01 1 32 15 11 1	32 15 01 2 32 15 11 2	32 15 01 3 32 15 11 3	32 15 01 4 32 15 11 4	32 15 01 5 32 15 11 5	32 15 01 6 32 15 11 6	32 15 01 7 32 15 11 7

Deckel flach — Capuchon plat — Flat cap

standard mat finish	35 15 00 1 35 15 10 1	35 15 00 2 35 15 10 2	35 15 00 3 35 15 10 3	35 15 00 4 35 15 10 4
standard mat finish	35 15 01 1 35 15 11 1	35 15 01 2 35 15 11 2	35 15 01 3 35 15 11 3	35 15 01 4 35 15 11 4

**Knopf
Bouton
Knob**



	φ				
standard	3	20 21 30 1	20 21 30 2	20 21 30 3	20 21 30 4
	1/8"	20 21 31 1	20 21 31 2	20 21 31 3	20 21 31 4
	4	20 21 40 1	20 21 40 2	20 21 40 3	20 21 40 4
	6	20 21 60 1	20 21 60 2	20 21 60 3	20 21 60 4
mat finish	1/4"	20 21 61 1	20 21 61 2	20 21 61 3	20 21 61 4
	3	26 21 30 1	26 21 30 2	26 21 30 3	26 21 30 4
	1/8"	26 21 31 1	26 21 31 2	26 21 31 3	26 21 31 4
	4	26 21 40 1	26 21 40 2	26 21 40 3	26 21 40 4
1/4"	6	26 21 60 1	26 21 60 2	26 21 60 3	26 21 60 4
	1/4"	26 21 61 1	26 21 61 2	26 21 61 3	26 21 61 4

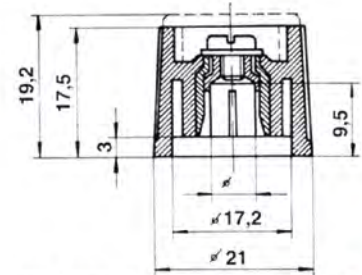

mit Strich – avec repère – with line

	φ				
standard	3	21 21 30 1	21 21 30 2	21 21 30 3	21 21 30 4
	1/8"	21 21 31 1	21 21 31 2	21 21 31 3	21 21 31 4
	4	21 21 40 1	21 21 40 2	21 21 40 3	21 21 40 4
	6	21 21 60 1	21 21 60 2	21 21 60 3	21 21 60 4
mat finish	1/4"	21 21 61 1	21 21 61 2	21 21 61 3	21 21 61 4
	3	27 21 30 1	27 21 30 2	27 21 30 3	27 21 30 4
	1/8"	27 21 31 1	27 21 31 2	27 21 31 3	27 21 31 4
	4	27 21 40 1	27 21 40 2	27 21 40 3	27 21 40 4
1/4"	6	27 21 60 1	27 21 60 2	27 21 60 3	27 21 60 4
	1/4"	27 21 61 1	27 21 61 2	27 21 61 3	27 21 61 4

**Knebelknopf
Bouton à oreilles
Wing knob**



	φ				
standard	3	22 21 30 1	22 21 30 2	22 21 30 3	22 21 30 4
	1/8"	22 21 31 1	22 21 31 2	22 21 31 3	22 21 31 4
	4	22 21 40 1	22 21 40 2	22 21 40 3	22 21 40 4
	6	22 21 60 1	22 21 60 2	22 21 60 3	22 21 60 4
mat finish	1/4"	22 21 61 1	22 21 61 2	22 21 61 3	22 21 61 4
	3	28 21 30 1	28 21 30 2	28 21 30 3	28 21 30 4
	1/8"	28 21 31 1	28 21 31 2	28 21 31 3	28 21 31 4
	4	28 21 40 1	28 21 40 2	28 21 40 3	28 21 40 4
1/4"	6	28 21 60 1	28 21 60 2	28 21 60 3	28 21 60 4
	1/4"	28 21 61 1	28 21 61 2	28 21 61 3	28 21 61 4

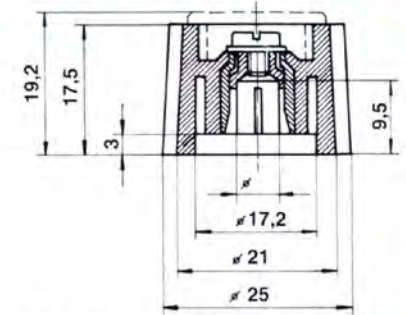

mit Strich – avec repère – with line

	φ				
standard	3	23 21 30 1	23 21 30 2	23 21 30 3	23 21 30 4
	1/8"	23 21 31 1	23 21 31 2	23 21 31 3	23 21 31 4
	4	23 21 40 1	23 21 40 2	23 21 40 3	23 21 40 4
	6	23 21 60 1	23 21 60 2	23 21 60 3	23 21 60 4
mat finish	1/4"	23 21 61 1	23 21 61 2	23 21 61 3	23 21 61 4
	3	29 21 30 1	29 21 30 2	29 21 30 3	29 21 30 4
	1/8"	29 21 31 1	29 21 31 2	29 21 31 3	29 21 31 4
	4	29 21 40 1	29 21 40 2	29 21 40 3	29 21 40 4
1/4"	6	29 21 60 1	29 21 60 2	29 21 60 3	29 21 60 4
	1/4"	29 21 61 1	29 21 61 2	29 21 61 3	29 21 61 4

**Pfeilknopf
Bouton à flèche
Arrow knob**



	φ				
standard	3	18 21 30 1	18 21 30 2	18 21 30 3	18 21 30 4
	1/8"	18 21 31 1	18 21 31 2	18 21 31 3	18 21 31 4
	4	18 21 40 1	18 21 40 2	18 21 40 3	18 21 40 4
	6	18 21 60 1	18 21 60 2	18 21 60 3	18 21 60 4
mat finish	1/4"	18 21 61 1	18 21 61 2	18 21 61 3	18 21 61 4
	3	16 21 30 1	16 21 30 2	16 21 30 3	16 21 30 4
	1/8"	16 21 31 1	16 21 31 2	16 21 31 3	16 21 31 4
	4	16 21 40 1	16 21 40 2	16 21 40 3	16 21 40 4
1/4"	6	16 21 60 1	16 21 60 2	16 21 60 3	16 21 60 4
	1/4"	16 21 61 1	16 21 61 2	16 21 61 3	16 21 61 4

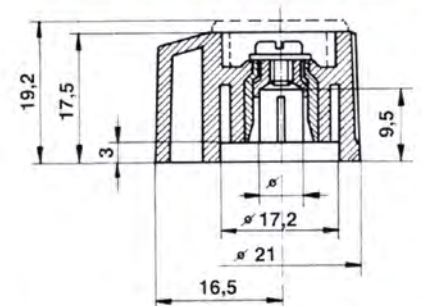

mit Strich – avec repère – with line

	φ				
standard	3	19 21 30 1	19 21 30 2	19 21 30 3	19 21 30 4
	1/8"	19 21 31 1	19 21 31 2	19 21 31 3	19 21 31 4
	4	19 21 40 1	19 21 40 2	19 21 40 3	19 21 40 4
	6	19 21 60 1	19 21 60 2	19 21 60 3	19 21 60 4
mat finish	1/4"	19 21 61 1	19 21 61 2	19 21 61 3	19 21 61 4
	3	17 21 30 1	17 21 30 2	17 21 30 3	17 21 30 4
	1/8"	17 21 31 1	17 21 31 2	17 21 31 3	17 21 31 4
	4	17 21 40 1	17 21 40 2	17 21 40 3	17 21 40 4
1/4"	6	17 21 60 1	17 21 60 2	17 21 60 3	17 21 60 4
	1/4"	17 21 61 1	17 21 61 2	17 21 61 3	17 21 61 4

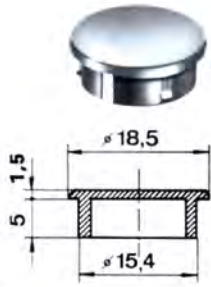

mit Strich
avec trait
with line

mit Schwellpfeil
avec flèche coudée
with curved arrow

mit Pfeil
avec flèche
with arrow

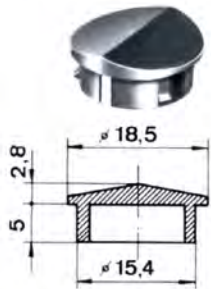

mit Punkt
avec point
with point



mit Strich
avec trait
with line

mit Aluminium-Scheibe
avec disque aluminium
with aluminium disk

mit Alu-Scheibe und Strich
avec disque alu et repère
with alu disk and line

Deckel flach – Capuchon plat – Flat cap

standard mat finish	30 21 00 1 30 21 10 1	30 21 00 2 30 21 10 2	30 21 00 3 30 21 10 3	30 21 00 4 30 21 10 4	30 21 00 5 30 21 10 5	30 21 00 6 30 21 10 6	30 21 00 7 30 21 10 7
standard mat finish	30 21 01 1 30 21 11 1	30 21 01 2 30 21 11 2	30 21 01 3 30 21 11 3	30 21 01 4 30 21 11 4	30 21 01 5 30 21 11 5	30 21 01 6 30 21 11 6	30 21 01 7 30 21 11 7
standard mat finish	30 21 02 1 30 21 12 1	30 21 02 2 30 21 12 2	30 21 02 3 30 21 12 3	30 21 02 4 30 21 12 4	30 21 02 5 30 21 12 5	30 21 02 6 30 21 12 6	30 21 02 7 30 21 12 7
standard mat finish	30 21 03 1 30 21 13 1	30 21 03 2 30 21 13 2	30 21 03 3 30 21 13 3	30 21 03 4 30 21 13 4	30 21 03 5 30 21 13 5	30 21 03 6 30 21 13 6	30 21 03 7 30 21 13 7

Deckel prismaform – Capuchon prismatique – Prismatic cap

standard mat finish	31 21 00 1 31 21 10 1	31 21 00 2 31 21 10 2	31 21 00 3 31 21 10 3	31 21 00 4 31 21 10 4	31 21 00 5 31 21 10 5	31 21 00 6 31 21 10 6	31 21 00 7 31 21 10 7
standard mat finish	31 21 04 1 31 21 14 1	31 21 04 2 31 21 14 2	31 21 04 3 31 21 14 3	31 21 04 4 31 21 14 4	31 21 04 5 31 21 14 5	31 21 04 6 31 21 14 6	31 21 04 7 31 21 14 7

Deckel bombiert – Capuchon courbé – Curved cap

standard mat finish	32 21 00 1 32 21 10 1	32 21 00 2 32 21 10 2	32 21 00 3 32 21 10 3	32 21 00 4 32 21 10 4	32 21 00 5 32 21 10 5	32 21 00 6 32 21 10 6	32 21 00 7 32 21 10 7
standard mat finish	32 21 01 1 32 21 11 1	32 21 01 2 32 21 11 2	32 21 01 3 32 21 11 3	32 21 01 4 32 21 11 4	32 21 01 5 32 21 11 5	32 21 01 6 32 21 11 6	32 21 01 7 32 21 11 7

Deckel flach – Capuchon plat – Flat cap

standard mat finish	35 21 00 1 35 21 10 1	35 21 00 2 35 21 10 2	35 21 00 3 35 21 10 3	35 21 00 4 35 21 10 4
standard mat finish	35 21 01 1 35 21 11 1	35 21 01 2 35 21 11 2	35 21 01 3 35 21 11 3	35 21 01 4 35 21 11 4

Knopf
Bouton
Knob

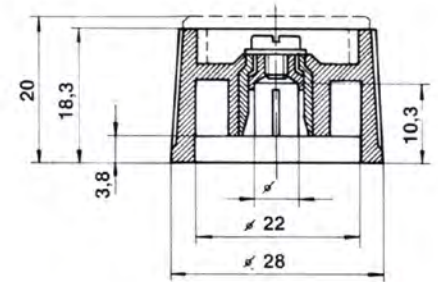

	φ	
standard	4	
	6	
	1/4"	
mat finish	4	
	6	
	1/4"	

	20 28 40 1	20 28 40 2	20 28 40 3	20 28 40 4
	20 28 60 1	20 28 60 2	20 28 60 3	20 28 60 4
	20 28 61 1	20 28 61 2	20 28 61 3	20 28 61 4
	26 28 40 1	26 28 40 2	26 28 40 3	26 28 40 4
	26 28 60 1	26 28 60 2	26 28 60 3	26 28 60 4
	26 28 61 1	26 28 61 2	26 28 61 3	26 28 61 4

mit Strich – avec repère – with line

	21 28 40 1	21 28 40 2	21 28 40 3	21 28 40 4
	21 28 60 1	21 28 60 2	21 28 60 3	21 28 60 4
	21 28 61 1	21 28 61 2	21 28 61 3	21 28 61 4
	27 28 40 1	27 28 40 2	27 28 40 3	27 28 40 4
	27 28 60 1	27 28 60 2	27 28 60 3	27 28 60 4
	27 28 61 1	27 28 61 2	27 28 61 3	27 28 61 4

Knebelknopf
Bouton à oreilles
Wing knob

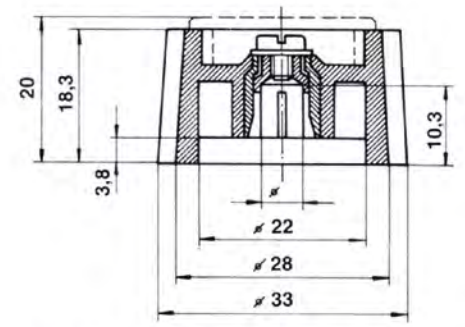

	φ	
standard	4	
	6	
	1/4"	
mat finish	4	
	6	
	1/4"	

	22 28 40 1	22 28 40 2	22 28 40 3	22 28 40 4
	22 28 60 1	22 28 60 2	22 28 60 3	22 28 60 4
	22 28 61 1	22 28 61 2	22 28 61 3	22 28 61 4
	28 28 40 1	28 28 40 2	28 28 40 3	28 28 40 4
	28 28 60 1	28 28 60 2	28 28 60 3	28 28 60 4
	28 28 61 1	28 28 61 2	28 28 61 3	28 28 61 4

mit Strich – avec repère – with line

	23 28 40 1	23 28 40 2	23 28 40 3	23 28 40 4
	23 28 60 1	23 28 60 2	23 28 60 3	23 28 60 4
	23 28 61 1	23 28 61 2	23 28 61 3	23 28 61 4
	29 28 40 1	29 28 40 2	29 28 40 3	29 28 40 4
	29 28 60 1	29 28 60 2	29 28 60 3	29 28 60 4
	29 28 61 1	29 28 61 2	29 28 61 3	29 28 61 4

Pfeilknopf
Bouton à flèche
Arrow knob

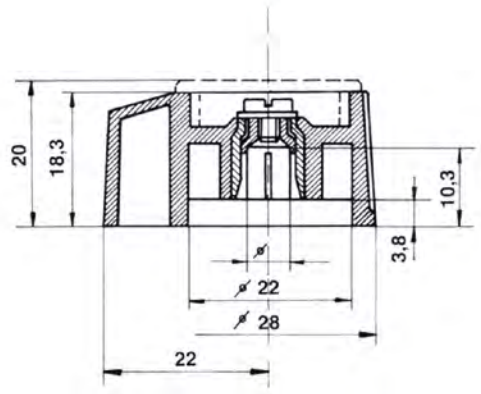

	φ	
standard	6	
	1/4"	
mat finish	6	
	1/4"	

	18 28 60 1	18 28 60 2	18 28 60 3	18 28 60 4
	18 28 61 1	18 28 61 2	18 28 61 3	18 28 61 4
	16 28 60 1	16 28 60 2	16 28 60 3	16 28 60 4
	16 28 61 1	16 28 61 2	16 28 61 3	16 28 61 4

mit Strich – avec repère – with line

	19 28 60 1	19 28 60 2	19 28 60 3	19 28 60 4
	19 28 61 1	19 28 61 2	19 28 61 3	19 28 61 4
	17 28 60 1	17 28 60 2	17 28 60 3	17 28 60 4
	17 28 61 1	17 28 61 2	17 28 61 3	17 28 61 4

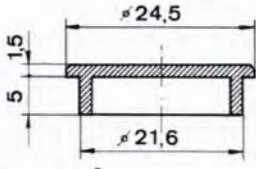

mit Strich
avec trait
with line

mit Schwellpfeil
avec flèche coudée
with curved arrow

mit Pfeil
avec flèche
with arrow

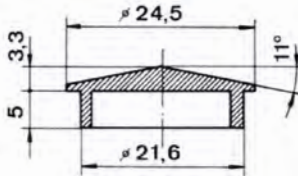

mit Punkt
avec point
with point

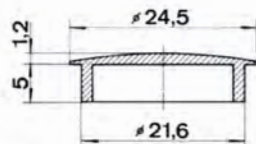

mit Strich
avec trait
with line

mit Aluminium-Scheibe
avec disque aluminium
with aluminium disk

mit Alu-Scheibe und Strich
avec disque alu et repère
with alu disk and line

Deckel flach – Capuchon plat – Flat cap

standard	30 28 00 1	30 28 00 2	30 28 00 3	30 28 00 4	30 28 00 5	30 28 00 6	30 28 00 7
mat finish	30 28 10 1	30 28 10 2	30 28 10 3	30 28 10 4	30 28 10 5	30 28 10 6	30 28 10 7
standard	30 28 01 1	30 28 01 2	30 28 01 3	30 28 01 4	30 28 01 5	30 28 01 6	30 28 01 7
mat finish	30 28 11 1	30 28 11 2	30 28 11 3	30 28 11 4	30 28 11 5	30 28 11 6	30 28 11 7
standard	30 28 02 1	30 28 02 2	30 28 02 3	30 28 02 4	30 28 02 5	30 28 02 6	30 28 02 7
mat finish	30 28 12 1	30 28 12 2	30 28 12 3	30 28 12 4	30 28 12 5	30 28 12 6	30 28 12 7
standard	30 28 03 1	30 28 03 2	30 28 03 3	30 28 03 4	30 28 03 5	30 28 03 6	30 28 03 7
mat finish	30 28 13 1	30 28 13 2	30 28 13 3	30 28 13 4	30 28 13 5	30 28 13 6	30 28 13 7

Deckel prismaform – Capuchon prismatique – Prismatic cap

standard	31 28 00 1	31 28 00 2	31 28 00 3	31 28 00 4	31 28 00 5	31 28 00 6	31 28 00 7
mat finish	31 28 10 1	31 28 10 2	31 28 10 3	31 28 10 4	31 28 10 5	31 28 10 6	31 28 10 7
standard	31 28 04 1	31 28 04 2	31 28 04 3	31 28 04 4	31 28 04 5	31 28 04 6	31 28 04 7
mat finish	31 28 14 1	31 28 14 2	31 28 14 3	31 28 14 4	31 28 14 5	31 28 14 6	31 28 14 7

Deckel bombiert – Capuchon courbé – Curved cap

standard	32 28 00 1	32 28 00 2	32 28 00 3	32 28 00 4	32 28 00 5	32 28 00 6	32 28 00 7
mat finish	32 28 10 1	32 28 10 2	32 28 10 3	32 28 10 4	32 28 10 5	32 28 10 6	32 28 10 7
standard	32 28 01 1	32 28 01 2	32 28 01 3	32 28 01 4	32 28 01 5	32 28 01 6	32 28 01 7
mat finish	32 28 11 1	32 28 11 2	32 28 11 3	32 28 11 4	32 28 11 5	32 28 11 6	32 28 11 7

Deckel flach – Capuchon plat – Flat cap

standard	35 28 00 1	35 28 00 2	35 28 00 3	35 28 00 4
mat finish	35 28 10 1	35 28 10 2	35 28 10 3	35 28 10 4
standard	35 28 01 1	35 28 01 2	35 28 01 3	35 28 01 4
mat finish	35 28 11 1	35 28 11 2	35 28 11 3	35 28 11 4

Knopf
Bouton
Knob

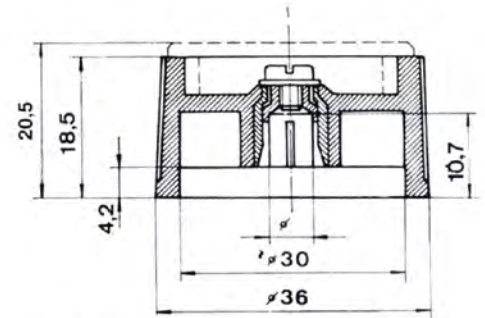

mit Strich – avec repère – with line



standard

φ
6
1/4"

20 36 60 1 20 36 60 2 20 36 60 3 20 36 60 4
20 36 61 1 20 36 61 2 20 36 61 3 20 36 61 4

21 36 60 1 21 36 60 2 21 36 60 3 21 36 60 4
21 36 61 1 21 36 61 2 21 36 61 3 21 36 61 4

mat finish

6
1/4"

26 36 60 1 26 36 60 2 26 36 60 3 26 36 60 4
26 36 61 1 26 36 61 2 26 36 61 3 26 36 61 4

27 36 60 1 27 36 60 2 27 36 60 3 27 36 60 4
27 36 61 1 27 36 61 2 27 36 61 3 27 36 61 4

Knebelknopf
Bouton à oreilles
Wing knob

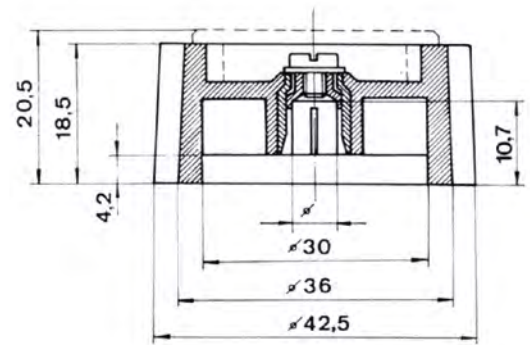

mit Strich – avec repère – with line



standard

φ
6
1/4"

22 36 60 1 22 36 60 2 22 36 60 3 22 36 60 4
22 36 61 1 22 36 61 2 22 36 61 3 22 36 61 4

23 36 60 1 23 36 60 2 23 36 60 3 23 36 60 4
23 36 61 1 23 36 61 2 23 36 61 3 23 36 61 4

mat finish

6
1/4"

28 36 60 1 28 36 60 2 28 36 60 3 28 36 60 4
28 36 61 1 28 36 61 2 28 36 61 3 28 36 61 4

29 36 60 1 29 36 60 2 29 36 60 3 29 36 60 4
29 36 61 1 29 36 61 2 29 36 61 3 29 36 61 4

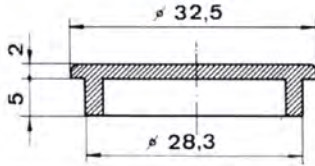

mit Strich
avec trait
with line

mit Schwellpfeil
avec flèche coudée
with curved arrow

mit Pfeil
avec flèche
with arrow

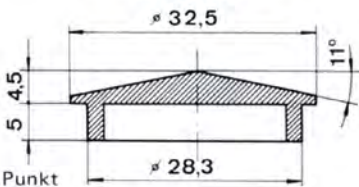

mit Punkt
avec point
with point

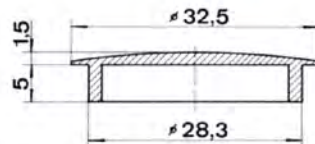

mit Strich
avec trait
with line

mit Aluminium-Scheibe
avec disque aluminium
with aluminium disk

mit Alu-Scheibe und Strich
avec disque alu et repère
with alu disk and line

Deckel flach – Capuchon plat – Flat cap

standard mat finish	30 36 00 1 30 36 10 1	30 36 00 2 30 36 10 2	30 36 00 3 30 36 10 3	30 36 00 4 30 36 10 4	30 36 00 5 30 36 10 5	30 36 00 6 30 36 10 6	30 36 00 7 30 36 10 7
standard mat finish	30 36 01 1 30 36 11 1	30 36 01 2 30 36 11 2	30 36 01 3 30 36 11 3	30 36 01 4 30 36 11 4	30 36 01 5 30 36 11 5	30 36 01 6 30 36 11 6	30 36 01 7 30 36 11 7
standard mat finish	30 36 02 1 30 36 12 1	30 36 02 2 30 36 12 2	30 36 02 3 30 36 12 3	30 36 02 4 30 36 12 4	30 36 02 5 30 36 12 5	30 36 02 6 30 36 12 6	30 36 02 7 30 36 12 7
standard mat finish	30 36 03 1 30 36 13 1	30 36 03 2 30 36 13 2	30 36 03 3 30 36 13 3	30 36 03 4 30 36 13 4	30 36 03 5 30 36 13 5	30 36 03 6 30 36 13 6	30 36 03 7 30 36 13 7

Deckel prismaform – Capuchon prismatique – Prismatic cap

standard mat finish	31 36 00 1 31 36 10 1	31 36 00 2 31 36 10 2	31 36 00 3 31 36 10 3	31 36 00 4 31 36 10 4	31 36 00 5 31 36 10 5	31 36 00 6 31 36 10 6	31 36 00 7 31 36 10 7
standard mat finish	31 36 04 1 31 36 14 1	31 36 04 2 31 36 14 2	31 36 04 3 31 36 14 3	31 36 04 4 31 36 14 4	31 36 04 5 31 36 14 5	31 36 04 6 31 36 14 6	31 36 04 7 31 36 14 7

Deckel bombiert – Capuchon courbé – Curved cap

standard mat finish	32 36 00 1 32 36 10 1	32 36 00 2 32 36 10 2	32 36 00 3 32 36 10 3	32 36 00 4 32 36 10 4	32 36 00 5 32 36 10 5	32 36 00 6 32 36 10 6	32 36 00 7 32 36 10 7
standard mat finish	32 36 01 1 32 36 11 1	32 36 01 2 32 36 11 2	32 36 01 3 32 36 11 3	32 36 01 4 32 36 11 4	32 36 01 5 32 36 11 5	32 36 01 6 32 36 11 6	32 36 01 7 32 36 11 7

Deckel flach – Capuchon plat – Flat cap

standard mat finish	35 36 00 1 35 36 10 1	35 36 00 2 35 36 10 2	35 36 00 3 35 36 10 3	35 36 00 4 35 36 10 4
standard mat finish	35 36 01 1 35 36 11 1	35 36 01 2 35 36 11 2	35 36 01 3 35 36 11 3	35 36 01 4 35 36 11 4

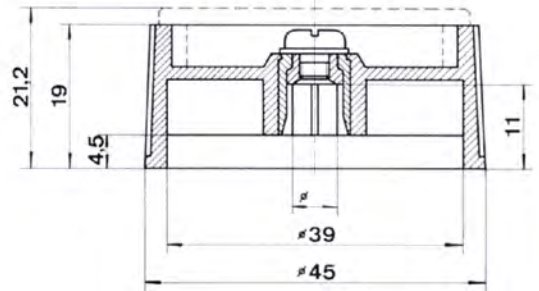

Knopf
Bouton
Knob

mit Strich – avec repère – with line

	Ø								
standard	6	20 45 60 1	20 45 60 2	20 45 60 3	20 45 60 4	21 45 60 1	21 45 60 2	21 45 60 3	21 45 60 4
	¼"	20 45 61 1	20 45 61 2	20 45 61 3	20 45 61 4	21 45 61 1	21 45 61 2	21 45 61 3	21 45 61 4
mat finish	6	26 45 60 1	26 45 60 2	26 45 60 3	26 45 60 4	27 45 60 1	27 45 60 2	27 45 60 3	27 45 60 4
	¼"	26 45 61 1	26 45 61 2	26 45 61 3	26 45 61 4	27 45 61 1	27 45 61 2	27 45 61 3	27 45 61 4

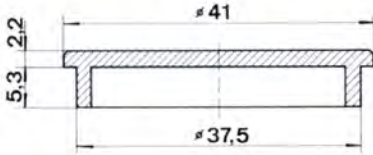

mit Strich
avec trait
with line

mit Schwellpfeil
avec flèche coudée
with curved arrow

mit Pfeil
avec flèche
with arrow

Deckel flach – Capuchon plat – Flat cap

standard mat finish	30 45 00 1 30 45 10 1	30 45 00 2 30 45 10 2	30 45 00 3 30 45 10 3	30 45 00 4 30 45 10 4	30 45 00 5 30 45 10 5	30 45 00 6 30 45 10 6	30 45 00 7 30 45 10 7
standard mat finish	30 45 01 1 30 45 11 1	30 45 01 2 30 45 11 2	30 45 01 3 30 45 11 3	30 45 01 4 30 45 11 4	30 45 01 5 30 45 11 5	30 45 01 6 30 45 11 6	30 45 01 7 30 45 11 7
standard mat finish	30 45 02 1 30 45 12 1	30 45 02 2 30 45 12 2	30 45 02 3 30 45 12 3	30 45 02 4 30 45 12 4	30 45 02 5 30 45 12 5	30 45 02 6 30 45 12 6	30 45 02 7 30 45 12 7
standard mat finish	30 45 03 1 30 45 13 1	30 45 03 2 30 45 13 2	30 45 03 3 30 45 13 3	30 45 03 4 30 45 13 4	30 45 03 5 30 45 13 5	30 45 03 6 30 45 13 6	30 45 03 7 30 45 13 7

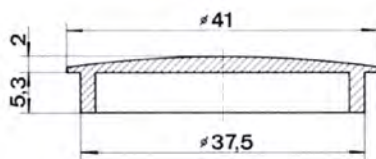

mit Strich
avec trait
with line

Deckel bombiert – Capuchon courbé – Curved cap

standard mat finish	32 45 00 1 32 45 10 1	32 45 00 2 32 45 10 2	32 45 00 3 32 45 10 3	32 45 00 4 32 45 10 4	32 45 00 5 32 45 10 5	32 45 00 6 32 45 10 6	32 45 00 7 32 45 10 7
standard mat finish	32 45 01 1 32 45 11 1	32 45 01 2 32 45 11 2	32 45 01 3 32 45 11 3	32 45 01 4 32 45 11 4	32 45 01 5 32 45 11 5	32 45 01 6 32 45 11 6	32 45 01 7 32 45 11 7

15 mm

Kurzknopf Bouton court Short knob



	0
	3
standard	1/8"
	4
	6
	1/4"
	3
	1/8"
mat finish	4
	6
	1/4"

60 15 30 1	60 15 30 2	60 15 30 3	60 15 30 4	61 15 30 1	61 15 30 2	61 15 30 3	61 15 30 4
60 15 31 1	60 15 31 2	60 15 31 3	60 15 31 4	61 15 31 1	61 15 31 2	61 15 31 3	61 15 31 4
60 15 40 1	60 15 40 2	60 15 40 3	60 15 40 4	61 15 40 1	61 15 40 2	61 15 40 3	61 15 40 4
60 15 60 1	60 15 60 2	60 15 60 3	60 15 60 4	61 15 60 1	61 15 60 2	61 15 60 3	61 15 60 4
60 15 61 1	60 15 61 2	60 15 61 3	60 15 61 4	61 15 61 1	61 15 61 2	61 15 61 3	61 15 61 4
66 15 30 1	66 15 30 2	66 15 30 3	66 15 30 4	67 15 30 1	67 15 30 2	67 15 30 3	67 15 30 4
66 15 31 1	66 15 31 2	66 15 31 3	66 15 31 4	67 15 31 1	67 15 31 2	67 15 31 3	67 15 31 4
66 15 40 1	66 15 40 2	66 15 40 3	66 15 40 4	67 15 40 1	67 15 40 2	67 15 40 3	67 15 40 4
66 15 60 1	66 15 60 2	66 15 60 3	66 15 60 4	67 15 60 1	67 15 60 2	67 15 60 3	67 15 60 4
66 15 61 1	66 15 61 2	66 15 61 3	66 15 61 4	67 15 61 1	67 15 61 2	67 15 61 3	67 15 61 4

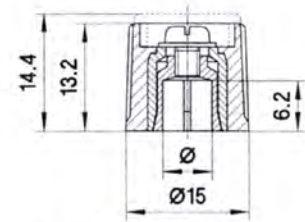

mit Strich – avec repère – with line

Kurzknobelknopf Bouton court à oreilles Short wing knob



	0
	3
standard	1/8"
	4
	6
	1/4"
	3
	1/8"
mat finish	4
	6
	1/4"

62 15 30 1	62 15 30 2	62 15 30 3	62 15 30 4	63 15 30 1	63 15 30 2	63 15 30 3	63 15 30 4
62 15 31 1	62 15 31 2	62 15 31 3	62 15 31 4	63 15 31 1	63 15 31 2	63 15 31 3	63 15 31 4
62 15 40 1	62 15 40 2	62 15 40 3	62 15 40 4	63 15 40 1	63 15 40 2	63 15 40 3	63 15 40 4
62 15 60 1	62 15 60 2	62 15 60 3	62 15 60 4	63 15 60 1	63 15 60 2	63 15 60 3	63 15 60 4
62 15 61 1	62 15 61 2	62 15 61 3	62 15 61 4	63 15 61 1	63 15 61 2	63 15 61 3	63 15 61 4
68 15 30 1	68 15 30 2	68 15 30 3	68 15 30 4	69 15 30 1	69 15 30 2	69 15 30 3	69 15 30 4
68 15 31 1	68 15 31 2	68 15 31 3	68 15 31 4	69 15 31 1	69 15 31 2	69 15 31 3	69 15 31 4
68 15 40 1	68 15 40 2	68 15 40 3	68 15 40 4	69 15 40 1	69 15 40 2	69 15 40 3	69 15 40 4
68 15 60 1	68 15 60 2	68 15 60 3	68 15 60 4	69 15 60 1	69 15 60 2	69 15 60 3	69 15 60 4
68 15 61 1	68 15 61 2	68 15 61 3	68 15 61 4	69 15 61 1	69 15 61 2	69 15 61 3	69 15 61 4

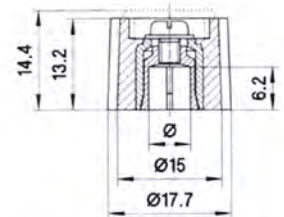

mit Strich – avec repère – with line

Zubehör Accessoires Accessories

Für diesen Kurzknopf können alle Zubehörteile verwendet werden.

Achtung: Bei den Deckeln muss zur normalen Bestell-Nummer auf Seite 13 der Zusatz «BV 204» beigefügt werden.

Tous les accessoires sont applicables pour ce bouton.

Attention: Pour les commandes des capuchons il faut ajouter au numéro normal de la commande à la page 13 le supplément «BV 204».

All accessories are usable for this knob.

Attention: For cap orders please add on the normal number on page 13 the addition «BV 204».

15 mm

Kurzknopf
Bouton court
Short knob



standard

mat finish

	∅								
standard	3	60 15 36 1	60 15 36 2	60 15 36 3	60 15 36 4	6115 36 1	6115 36 2	6115 36 3	6115 36 4
	1/8"	60 15 37 1	60 15 37 2	60 15 37 3	60 15 37 4	6115 37 1	6115 37 2	6115 37 3	6115 37 4
	4	60 15 46 1	60 15 46 2	60 15 46 3	60 15 46 4	6115 46 1	6115 46 2	6115 46 3	6115 46 4
	1/4"	60 15 70 1	60 15 70 2	60 15 70 3	60 15 70 4	6115 70 1	6115 70 2	6115 70 3	6115 70 4
mat finish	3	66 15 36 1	66 15 36 2	66 15 36 3	66 15 36 4	67 15 36 1	67 15 36 2	67 15 36 3	67 15 36 4
	1/8"	66 15 37 1	66 15 37 2	66 15 37 3	66 15 37 4	67 15 37 1	67 15 37 2	67 15 37 3	67 15 37 4
	4	66 15 46 1	66 15 46 2	66 15 46 3	66 15 46 4	67 15 46 1	67 15 46 2	67 15 46 3	67 15 46 4
	1/4"	66 15 70 1	66 15 70 2	66 15 70 3	66 15 70 4	67 15 70 1	67 15 70 2	67 15 70 3	67 15 70 4

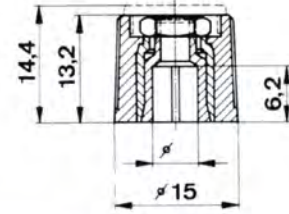

mit Strich – avec repère – with line

Kurzknobelknopf
Bouton court à oreilles
Short wing knob



standard

mat finish

	∅								
standard	3	62 15 36 1	62 15 36 2	62 15 36 3	62 15 36 4	63 15 36 1	63 15 36 2	63 15 36 3	63 15 36 4
	1/8"	62 15 37 1	62 15 37 2	62 15 37 3	62 15 37 4	63 15 37 1	63 15 37 2	63 15 37 3	63 15 37 4
	4	62 15 46 1	62 15 46 2	62 15 46 3	62 15 46 4	63 15 46 1	63 15 46 2	63 15 46 3	63 15 46 4
	1/4"	62 15 70 1	62 15 70 2	62 15 70 3	62 15 70 4	63 15 70 1	63 15 70 2	63 15 70 3	63 15 70 4
mat finish	3	68 15 36 1	68 15 36 2	68 15 36 3	68 15 36 4	69 15 36 1	69 15 36 2	69 15 36 3	69 15 36 4
	1/8"	68 15 37 1	68 15 37 2	68 15 37 3	68 15 37 4	69 15 37 1	69 15 37 2	69 15 37 3	69 15 37 4
	4	68 15 46 1	68 15 46 2	68 15 46 3	68 15 46 4	69 15 46 1	69 15 46 2	69 15 46 3	69 15 46 4
	1/4"	68 15 70 1	68 15 70 2	68 15 70 3	68 15 70 4	69 15 70 1	69 15 70 2	69 15 70 3	69 15 70 4

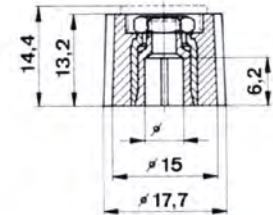

mit Strich – avec repère – with line

Zubehör
Accessoires
Accessories

Für diesen Kurzknopf können alle Zubehörteile verwendet werden.

Achtung: Bei den Deckeln muss zur normalen Bestell-Nummer auf Seite 13 der Zusatz «BV 204» beigefügt werden.

Tous les accessoires sont applicables pour ce bouton.

Attention: Pour les commandes des capuchons il faut ajouter au numéro normal de la commande à la page 13 le supplément «BV 204».

All accessories are usable for this knob.

Attention: For cap orders please add on the normal number on page 13 the addition «BV 204».

21 mm

Kurzknopf
Bouton court
Short knob

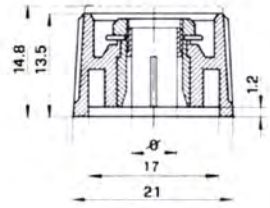

	Ø				
standard	3	60 21 36 1	60 21 36 2	60 21 36 3	60 21 36 4
	1/8"	60 21 37 1	60 21 37 2	60 21 37 3	60 21 37 4
	4	60 21 46 1	60 21 46 2	60 21 46 3	60 21 46 4
	6	60 21 76 1	60 21 76 2	60 21 76 3	60 21 76 4
mat finish	1/4"	60 21 75 1	60 21 75 2	60 21 75 3	60 21 75 4
	3	66 21 36 1	66 21 36 2	66 21 36 3	66 21 36 4
	1/8"	66 21 37 1	66 21 37 2	66 21 37 3	66 21 37 4
	4	66 21 46 1	66 21 46 2	66 21 46 3	66 21 46 4
mat finish	6	66 21 76 1	66 21 76 2	66 21 76 3	66 21 76 4
	1/4"	66 21 75 1	66 21 75 2	66 21 75 3	66 21 75 4

mit Strich — avec repère — with line

mit Strich	61 21 36 1	61 21 36 2	61 21 36 3	61 21 36 4
	61 21 37 1	61 21 37 2	61 21 37 3	61 21 37 4
	61 21 46 1	61 21 46 2	61 21 46 3	61 21 46 4
	61 21 76 1	61 21 76 2	61 21 76 3	61 21 76 4
mit Strich	61 21 75 1	61 21 75 2	61 21 75 3	61 21 75 4
	67 21 36 1	67 21 36 2	67 21 36 3	67 21 36 4
	67 21 37 1	67 21 37 2	67 21 37 3	67 21 37 4
	67 21 46 1	67 21 46 2	67 21 46 3	67 21 46 4
mit Strich	67 21 76 1	67 21 76 2	67 21 76 3	67 21 76 4
	67 21 75 1	67 21 75 2	67 21 75 3	67 21 75 4

28 mm

Kurzknopf
Bouton court
Short knob

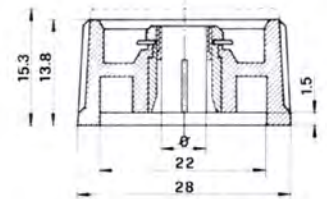

	Ø				
standard	4	60 28 46 1	60 28 46 2	60 28 46 3	60 28 46 4
	6	60 28 76 1	60 28 76 2	60 28 76 3	60 28 76 4
	1/4"	60 28 75 1	60 28 75 2	60 28 75 3	60 28 75 4
	4	66 28 46 1	66 28 46 2	66 28 46 3	66 28 46 4
mat finish	6	66 28 76 1	66 28 76 2	66 28 76 3	66 28 76 4
	1/4"	66 28 75 1	66 28 75 2	66 28 75 3	66 28 75 4

mit Strich — avec repère — with line

mit Strich	61 28 46 1	61 28 46 2	61 28 46 3	61 28 46 4
	61 28 76 1	61 28 76 2	61 28 76 3	61 28 76 4
	61 28 75 1	61 28 75 2	61 28 75 3	61 28 75 4
	67 28 46 1	67 28 46 2	67 28 46 3	67 28 46 4
mit Strich	67 28 76 1	67 28 76 2	67 28 76 3	67 28 76 4
	67 28 75 1	67 28 75 2	67 28 75 3	67 28 75 4

36 mm

Kurzknopf
Bouton court
Short knob

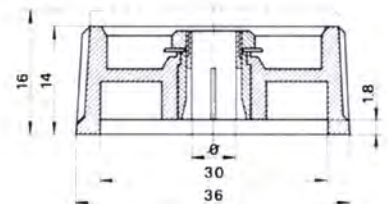

	Ø				
standard	6	60 36 76 1	60 36 76 2	60 36 76 3	60 36 76 4
	1/4"	60 36 75 1	60 36 75 2	60 36 75 3	60 36 75 4
	6	66 36 76 1	66 36 76 2	66 36 76 3	66 36 76 4
	1/4"	66 36 75 1	66 36 75 2	66 36 75 3	66 36 75 4

mit Strich — avec repère — with line

mit Strich	61 36 76 1	61 36 76 2	61 36 76 3	61 36 76 4
	61 36 75 1	61 36 75 2	61 36 75 3	61 36 75 4
	67 36 76 1	67 36 76 2	67 36 76 3	67 36 76 4
	67 36 75 1	67 36 75 2	67 36 75 3	67 36 75 4

21 mm

Kurzkebelknopf
Bouton court à oreilles
Short wing knob

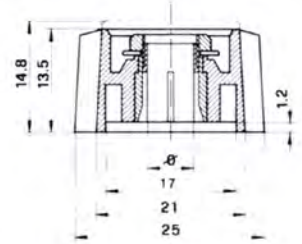

	Ø										
standard	3	62 21 36 1	62 21 36 2	62 21 36 3	62 21 36 4	63 21 36 1	63 21 36 2	63 21 36 3	63 21 36 4		
	1/8"	62 21 37 1	62 21 37 2	62 21 37 3	62 21 37 4	63 21 37 1	63 21 37 2	63 21 37 3	63 21 37 4		
	4	62 21 46 1	62 21 46 2	62 21 46 3	62 21 46 4	63 21 46 1	63 21 46 2	63 21 46 3	63 21 46 4		
	6	62 21 76 1	62 21 76 2	62 21 76 3	62 21 76 4	63 21 76 1	63 21 76 2	63 21 76 3	63 21 76 4		
mat finish	1/4"	62 21 75 1	62 21 75 2	62 21 75 3	62 21 75 4	63 21 75 1	63 21 75 2	63 21 75 3	63 21 75 4		
	3	68 21 36 1	68 21 36 2	68 21 36 3	68 21 36 4	69 21 36 1	69 21 36 2	69 21 36 3	69 21 36 4		
	1/8"	68 21 37 1	68 21 37 2	68 21 37 3	68 21 37 4	69 21 37 1	69 21 37 2	69 21 37 3	69 21 37 4		
	4	68 21 46 1	68 21 46 2	68 21 46 3	68 21 46 4	69 21 46 1	69 21 46 2	69 21 46 3	69 21 46 4		
1/4"	6	68 21 76 1	68 21 76 2	68 21 76 3	68 21 76 4	69 21 76 1	69 21 76 2	69 21 76 3	69 21 76 4		
	6	68 21 75 1	68 21 75 2	68 21 75 3	68 21 75 4	69 21 75 1	69 21 75 2	69 21 75 3	69 21 75 4		

28 mm

Kurzkebelknopf
Bouton court à oreilles
Short wing knob

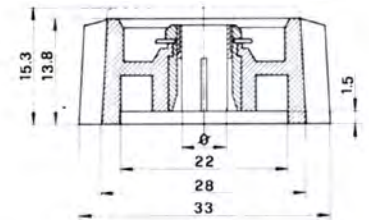

	Ø										
standard	4	62 28 46 1	62 28 46 2	62 28 46 3	62 28 46 4	63 28 46 1	63 28 46 2	63 28 46 3	63 28 46 4		
	6	62 28 76 1	62 28 76 2	62 28 76 3	62 28 76 4	63 28 76 1	63 28 76 2	63 28 76 3	63 28 76 4		
	1/4"	62 28 75 1	62 28 75 2	62 28 75 3	62 28 75 4	63 28 75 1	63 28 75 2	63 28 75 3	63 28 75 4		
mat finish	4	68 28 46 1	68 28 46 2	68 28 46 3	68 28 46 4	69 28 46 1	69 28 46 2	69 28 46 3	69 28 46 4		
	6	68 28 76 1	68 28 76 2	68 28 76 3	68 28 76 4	69 28 76 1	69 28 76 2	69 28 76 3	69 28 76 4		
	1/4"	68 28 75 1	68 28 75 2	68 28 75 3	68 28 75 4	69 28 75 1	69 28 75 2	69 28 75 3	69 28 75 4		

36 mm

Kurzkebelknopf
Bouton court à oreilles
Short wing knob

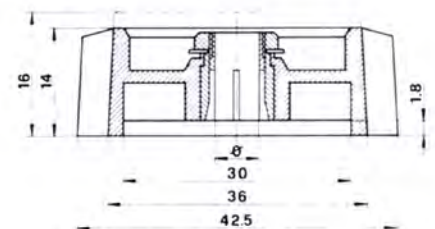

	Ø										
standard	6	62 36 76 1	62 36 76 2	62 36 76 3	62 36 76 4	63 36 76 1	63 36 76 2	63 36 76 3	63 36 76 4		
	1/4"	62 36 75 1	62 36 75 2	62 36 75 3	62 36 75 4	63 36 75 1	63 36 75 2	63 36 75 3	63 36 75 4		
mat finish	6	68 36 76 1	68 36 76 2	68 36 76 3	68 36 76 4	69 36 76 1	69 36 76 2	69 36 76 3	69 36 76 4		
	1/4"	68 36 75 1	68 36 75 2	68 36 75 3	68 36 75 4	69 36 75 1	69 36 75 2	69 36 75 3	69 36 75 4		

Pfeilscheibe/Zahlscheibe – Disque à flèche/Cadran – Arrow dial/Figure dial

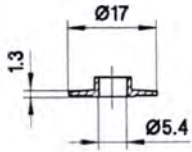

8 mm

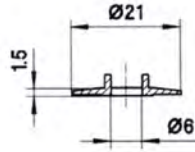

10 mm

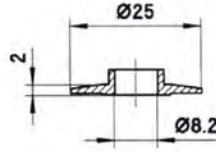

13 mm

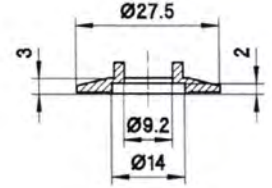

15 mm

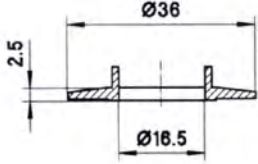

21 mm

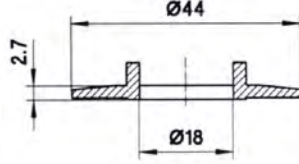

28 mm

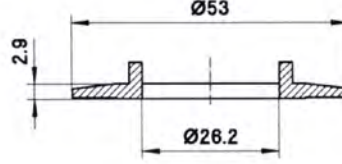

36 mm

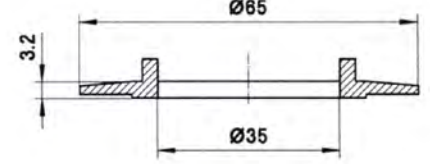

45 mm

Stator

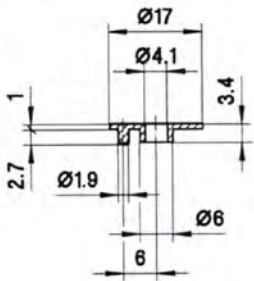

8 mm

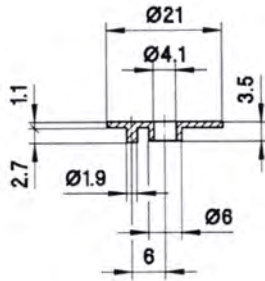

10 mm

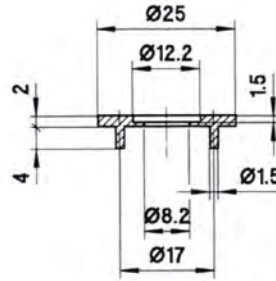

13 mm

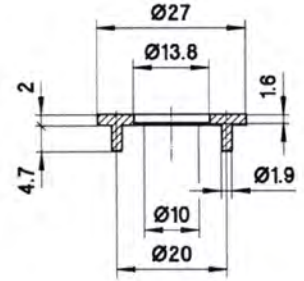

15 mm

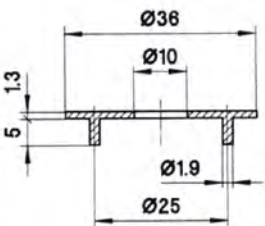
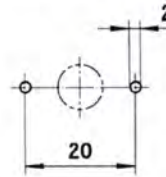
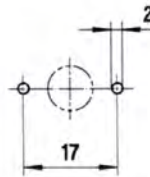
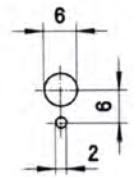
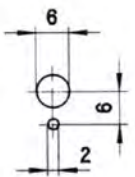

21 mm

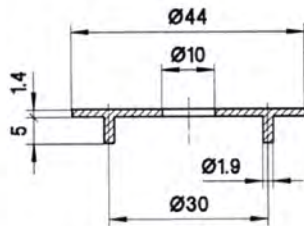

28 mm

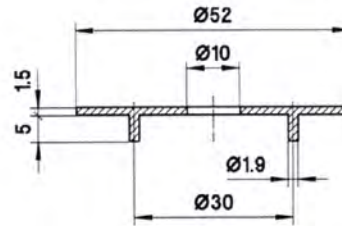

36 mm

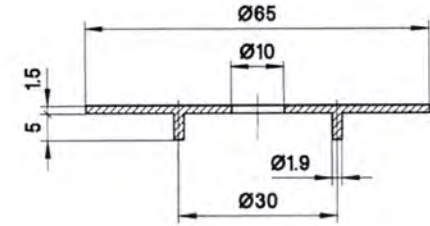

45 mm

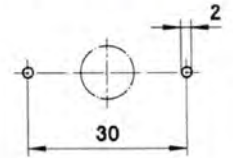
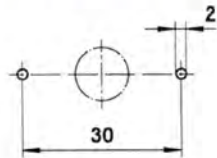
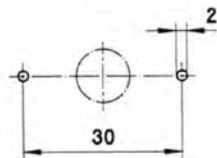
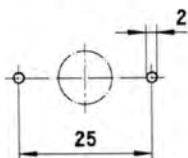

Zahlenscheibe – Cadran – Figure dial

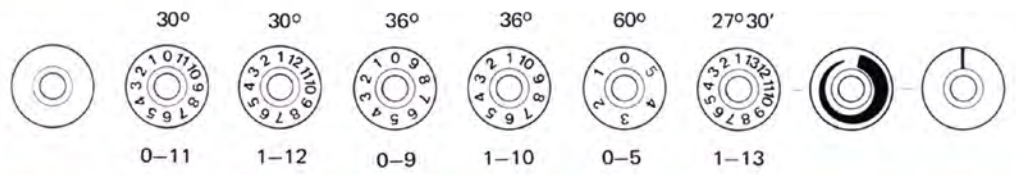

8 mm	46 08 00 0	46 08 01 0	46 08 02 0	46 08 03 0	46 08 04 0	46 08 05 0	46 08 06 0	46 08 10 0	46 08 11 0
10 mm	46 10 00 0	46 10 01 0	46 10 02 0	46 10 03 0	46 10 04 0	46 10 05 0	46 10 06 0	46 10 10 0	46 10 11 0
13 mm	46 13 00 0	46 13 01 0	46 13 02 0	46 13 03 0	46 13 04 0	46 13 05 0	46 13 06 0	46 13 10 0	46 13 11 0
15 mm	46 15 00 0	46 15 01 0	46 15 02 0	46 15 03 0	46 15 04 0	46 15 05 0	46 15 06 0	46 15 10 0	46 15 11 0
21 mm	46 21 00 0	46 21 01 0	46 21 02 0	46 21 03 0	46 21 04 0	46 21 05 0	46 21 06 0	46 21 10 0	46 21 11 0
28 mm	46 28 00 0	46 28 01 0	46 28 02 0	46 28 03 0	46 28 04 0	46 28 05 0	46 28 06 0	46 28 10 0	46 28 11 0
36 mm	46 36 00 0	46 36 01 0	46 36 02 0	46 36 03 0	46 36 04 0	46 36 05 0	46 36 06 0	46 36 10 0	46 36 11 0
45 mm	46 45 00 0	46 45 01 0	46 45 02 0	46 45 03 0	46 45 04 0	46 45 05 0	46 45 06 0	46 45 10 0	46 45 11 0

Pfeilscheibe – Disque à flèche – Arrow dial



8 mm	standard mat finish	45 08 01 1	45 08 01 2	45 08 01 3	45 08 01 4	45 08 02 1	45 08 02 2	45 08 02 3	45 08 02 4
		45 08 11 1	45 08 11 2	45 08 11 3	45 08 11 4	45 08 12 1	45 08 12 2	45 08 12 3	45 08 12 4
10 mm	standard mat finish	45 10 01 1	45 10 01 2	45 10 01 3	45 10 01 4	45 10 02 1	45 10 02 2	45 10 02 3	45 10 02 4
		45 10 11 1	45 10 11 2	45 10 11 3	45 10 11 4	45 10 12 1	45 10 12 2	45 10 12 3	45 10 12 4
13 mm	standard mat finish	45 13 01 1	45 13 01 2	45 13 01 3	45 13 01 4	45 13 02 1	45 13 02 2	45 13 02 3	45 13 02 4
		45 13 11 1	45 13 11 2	45 13 11 3	45 13 11 4	45 13 12 1	45 13 12 2	45 13 12 3	45 13 12 4
15 mm	standard mat finish	45 15 01 1	45 15 01 2	45 15 01 3	45 15 01 4	45 15 02 1	45 15 02 2	45 15 02 3	45 15 02 4
		45 15 11 1	45 15 11 2	45 15 11 3	45 15 11 4	45 15 12 1	45 15 12 2	45 15 12 3	45 15 12 4
21 mm	standard mat finish	45 21 01 1	45 21 01 2	45 21 01 3	45 21 01 4	45 21 02 1	45 21 02 2	45 21 02 3	45 21 02 4
		45 21 11 1	45 21 11 2	45 21 11 3	45 21 11 4	45 21 12 1	45 21 12 2	45 21 12 3	45 21 12 4
28 mm	standard mat finish	45 28 01 1	45 28 01 2	45 28 01 3	45 28 01 4	45 28 02 1	45 28 02 2	45 28 02 3	45 28 02 4
		45 28 11 1	45 28 11 2	45 28 11 3	45 28 11 4	45 28 12 1	45 28 12 2	45 28 12 3	45 28 12 4
36 mm	standard mat finish	45 36 01 1	45 36 01 2	45 36 01 3	45 36 01 4	45 36 02 1	45 36 02 2	45 36 02 3	45 36 02 4
		45 36 11 1	45 36 11 2	45 36 11 3	45 36 11 4	45 36 12 1	45 36 12 2	45 36 12 3	45 36 12 4
45 mm	standard mat finish	45 45 01 1	45 45 01 2	45 45 01 3	45 45 01 4	45 45 02 1	45 45 02 2	45 45 02 3	45 45 02 4
		45 45 11 1	45 45 11 2	45 45 11 3	45 45 11 4	45 45 12 1	45 45 12 2	45 45 12 3	45 45 12 4

Stator



8 mm	47 08 01 1
10 mm	47 10 01 1
13 mm	47 13 01 1
15 mm	47 15 01 1
21 mm	47 21 01 1
28 mm	47 28 01 1
36 mm	47 36 01 1
45 mm	47 45 01 1

8 mm	47 08 02 3
10 mm	47 10 02 3
13 mm	47 13 02 3
15 mm	47 15 02 3
21 mm	47 21 02 3
28 mm	47 28 02 3
36 mm	47 36 02 3
45 mm	47 45 02 3



Pfeil – Flèche – Arrow



8 mm	standard mat finish	40 08 00 1 40 08 10 1	40 08 00 2 40 08 10 2	40 08 00 3 40 08 10 3	40 08 00 4 40 08 10 4	40 08 00 5 40 08 10 5	40 08 00 6 40 08 10 6	40 08 00 7 40 08 10 7
10 mm	standard mat finish	40 10 00 1 40 10 10 1	40 10 00 2 40 10 10 2	40 10 00 3 40 10 10 3	40 10 00 4 40 10 10 4	40 10 00 5 40 10 10 5	40 10 00 6 40 10 10 6	40 10 00 7 40 10 10 7
13 mm	standard mat finish	40 13 00 1 40 13 10 1	40 13 00 2 40 13 10 2	40 13 00 3 40 13 10 3	40 13 00 4 40 13 10 4	40 13 00 5 40 13 10 5	40 13 00 6 40 13 10 6	40 13 00 7 40 13 10 7
15 mm	standard mat finish	40 15 00 1 40 15 10 1	40 15 00 2 40 15 10 2	40 15 00 3 40 15 10 3	40 15 00 4 40 15 10 4	40 15 00 5 40 15 10 5	40 15 00 6 40 15 10 6	40 15 00 7 40 15 10 7
21 mm	standard mat finish	40 21 00 1 40 21 10 1	40 21 00 2 40 21 10 2	40 21 00 3 40 21 10 3	40 21 00 4 40 21 10 4	40 21 00 5 40 21 10 5	40 21 00 6 40 21 10 6	40 21 00 7 40 21 10 7
28 mm	standard mat finish	40 28 00 1 40 28 10 1	40 28 00 2 40 28 10 2	40 28 00 3 40 28 10 3	40 28 00 4 40 28 10 4	40 28 00 5 40 28 10 5	40 28 00 6 40 28 10 6	40 28 00 7 40 28 10 7
36 mm	standard mat finish	40 36 00 1 40 36 10 1	40 36 00 2 40 36 10 2	40 36 00 3 40 36 10 3	40 36 00 4 40 36 10 4	40 36 00 5 40 36 10 5	40 36 00 6 40 36 10 6	40 36 00 7 40 36 10 7
45 mm	standard mat finish	40 45 00 1 40 45 10 1	40 45 00 2 40 45 10 2	40 45 00 3 40 45 10 3	40 45 00 4 40 45 10 4	40 45 00 5 40 45 10 5	40 45 00 6 40 45 10 6	40 45 00 7 40 45 10 7

Pfeil – Flèche – Arrow

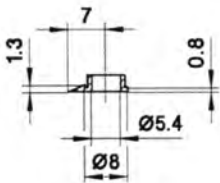

8 mm

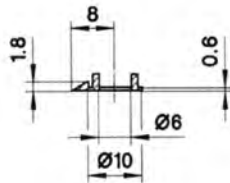

10 mm

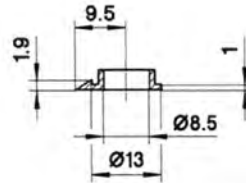

13 mm

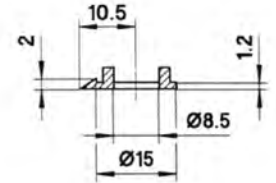

15 mm

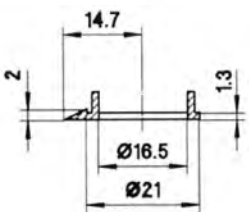

21 mm

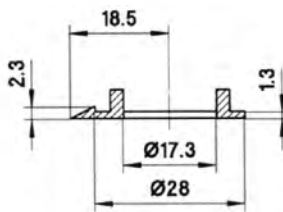

28 mm

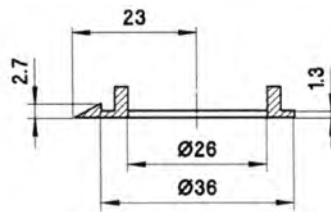

36 mm

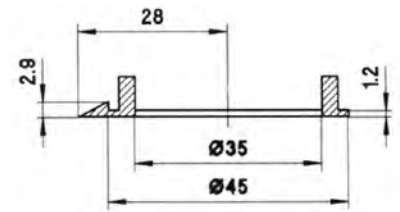

45 mm

Mutterabdeckung – Jupe – Nut cover

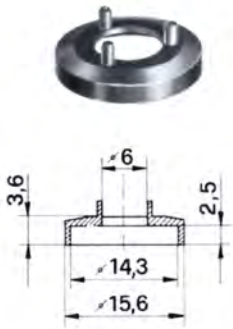

∅ 10 mm

ohne Strich

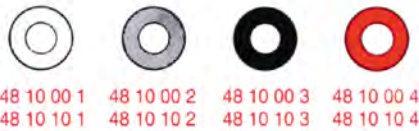

standard
mat finish

48 10 00 1 48 10 00 2 48 10 00 3 48 10 00 4
48 10 10 1 48 10 10 2 48 10 10 3 48 10 10 4

mit Strich

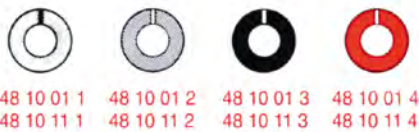

standard
mat finish

48 10 01 1 48 10 01 2 48 10 01 3 48 10 01 4
48 10 11 1 48 10 11 2 48 10 11 3 48 10 11 4

mit Strich für Knebelknöpfe
avec trait pour boutons à oreilles
with line for wing knobs

standard
mat finish

48 10 02 1 48 10 02 2 48 10 02 3 48 10 02 4
48 10 12 1 48 10 12 2 48 10 12 3 48 10 12 4

mit Pfeil

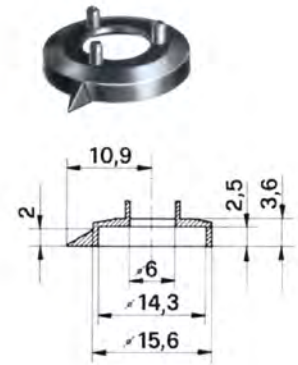

48 10 03 1 48 10 03 2 48 10 03 3 48 10 03 4
48 10 13 1 48 10 13 2 48 10 13 3 48 10 13 4

∅ 13 mm

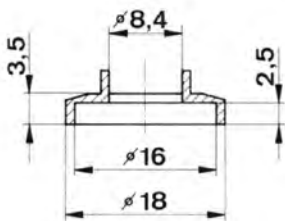

ohne Strich

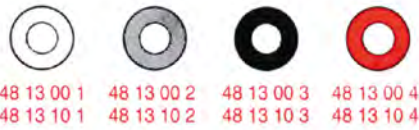

standard
mat finish

48 13 00 1 48 13 00 2 48 13 00 3 48 13 00 4
48 13 10 1 48 13 10 2 48 13 10 3 48 13 10 4

mit Strich

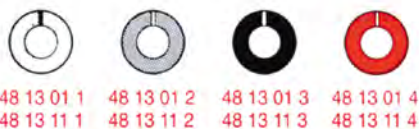

standard
mat finish

48 13 01 1 48 13 01 2 48 13 01 3 48 13 01 4
48 13 11 1 48 13 11 2 48 13 11 3 48 13 11 4

mit Strich für Knebelknöpfe
avec trait pour boutons à oreilles
with line for wing knobs

standard
mat finish

48 13 02 1 48 13 02 2 48 13 02 3 48 13 02 4
48 13 12 1 48 13 12 2 48 13 12 3 48 13 12 4

∅ 15 mm

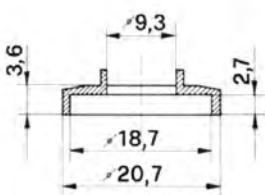

15 mm

ohne Strich

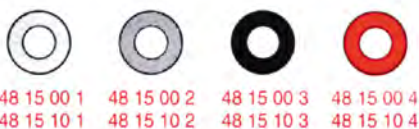

standard
mat finish

48 15 00 1 48 15 00 2 48 15 00 3 48 15 00 4
48 15 10 1 48 15 10 2 48 15 10 3 48 15 10 4

mit Strich



standard
mat finish

48 15 01 1 48 15 01 2 48 15 01 3 48 15 01 4
48 15 11 1 48 15 11 2 48 15 11 3 48 15 11 4

mit Strich für Knebelknöpfe
avec trait pour boutons à oreilles
with line for wing knobs

standard
mat finish

48 15 02 1 48 15 02 2 48 15 02 3 48 15 02 4
48 15 12 1 48 15 12 2 48 15 12 3 48 15 12 4

mit Pfeil

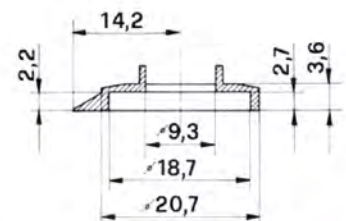

48 15 03 1 48 15 03 2 48 15 03 3 48 15 03 4
48 15 13 1 48 15 13 2 48 15 13 3 48 15 13 4

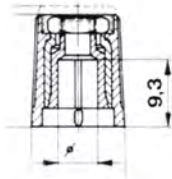

Spannzange – Pince de serrage – Collet

13 mm	∅ 3 mm	= 36
	∅ 1/8"	= 37
	∅ 4 mm	= 46
	∅ 6 mm	= 70
	∅ 1/4"	= 71

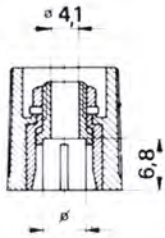

Spannzange – Pince de serrage – Collet

15 mm	∅ 3 mm	= 36
	∅ 1/8"	= 37
	∅ 4 mm	= 46
	∅ 6 mm	= 70
	∅ 1/4"	= 71

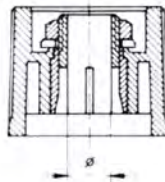

21–45 mm	∅ 3 mm	= 36
	∅ 1/8"	= 37
	∅ 4 mm	= 46
	∅ 6 mm	= 76
	∅ 1/4"	= 75

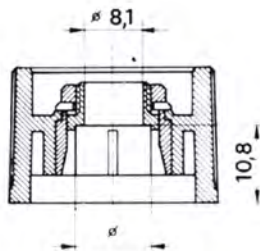

28–45 mm	∅ 8 mm	= 80*
	∅ 10 mm	= 10*

*Für Pfeilknopf 28 mm nicht lieferbar
*Pour bouton à flèche 28 mm non livrable
*Not available for arrow knob 28 mm

Für Knöpfe mit durchgehender Spannzange ändern Sie die Spannzangen-Nummer, alle Angaben finden Sie auf den entsprechenden Seiten.

Pour boutons avec pince coaxiale rechanger que les numéros de pince de serrage, vous trouverez tous les autres informations sur les pages correspondantes.

For knobs with coaxial collets change the collets according to their code-numbers, you will find all further information on corresponding pages.

Bestellcode – Code de commande – Order code

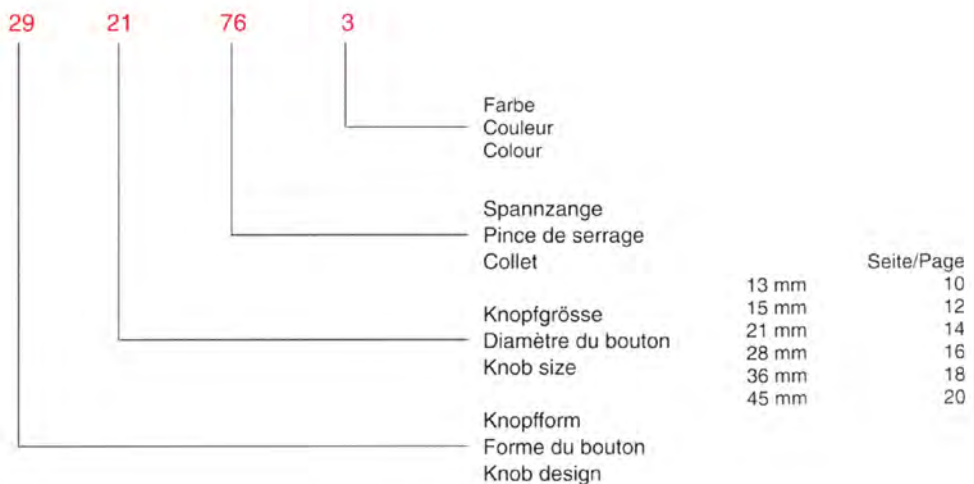



Beispiele – Exemples – Exemples

				Seite/Page
①	Deckel 15 mm, mat finish, grau Capuchon 15 mm, mat finish, gris Cap 15 mm, mat finish, grey	30 15 10 1		13
②	Knopf 15 mm, mat finish, schwarz, Spannzone 4 mm Bouton 15 mm, mat finish, noir, pince de serrage 4 mm Knob 15 mm, mat finish, black, collet 4 mm	26 15 40 3		12
③	Zwischendeckel 21 mm, mat finish, grau Capuchon intermédiaire 21 mm, mat finish, gris Intermediate cap 21 mm, mat finish, grey	38 21 10 1		31
④	Knebelknopf 21 mm, mit Strich, mat finish, schwarz, Spannzone 6 mm Bouton à oreilles 21 mm, avec repère, mat finish, noir, pince de serrage 6 mm Wing knob 21 mm, with line, mat finish, black, collet 6 mm	29 21 76 3		14
⑤	Deckel 21 mm, mat finish, grau Capuchon 21 mm, mat finish, gris Cap 21 mm, mat finish, grey	30 21 10 1		15
⑥	Kurzknopf 21 mm, mat finish, schwarz, Spannzone 4 mm Bouton court 21 mm, mat finish, noir, pince de serrage 4 mm Short knob 21 mm, mat finish, black, collet 4 mm	66 21 46 3		24
⑦	Zwischendeckel 28 mm, mat finish, grau Capuchon intermédiaire 28 mm, mat finish, gris Intermediate cap 28 mm, mat finish, grey	38 28 10 1		31
⑧	Kurzknobelknopf 28 mm, mat finish, schwarz, Spannzone 6 mm Bouton court à oreilles 28 mm, mat finish, noir, pince de serrage 6 mm Wing knob short 28 mm, mat finish, black, collet 6 mm	68 28 76 3		25

Zwischendeckel – Capuchon intermédiaire – Intermediate cap

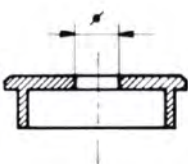

15 mm	4,5	standard	38 15 00 1	38 15 00 2	38 15 00 3	38 15 00 4
		mat finish	38 15 10 1	38 15 10 2	38 15 10 3	38 15 10 4
21 mm	6,5	standard	38 21 00 1	38 21 00 2	38 21 00 3	38 21 00 4
		mat finish	38 21 10 1	38 21 10 2	38 21 10 3	38 21 10 4
28 mm	6,5	standard	38 28 00 1	38 28 00 2	38 28 00 3	38 28 00 4
		mat finish	38 28 10 1	38 28 10 2	38 28 10 3	38 28 10 4
36 mm	6,5	standard	38 36 00 1	38 36 00 2	38 36 00 3	38 36 00 4
		mat finish	38 36 10 1	38 36 10 2	38 36 10 3	38 36 10 4
45 mm	6,5	standard	38 45 00 1	38 45 00 2	38 45 00 3	38 45 00 4
		mat finish	38 45 10 1	38 45 10 2	38 45 10 3	38 45 10 4

Das RITEL Steckknopfprogramm ist eine Erweiterung zu den bestehenden Spannzangenknöpfen und speziell für Grossverbraucher gedacht.

In Design, Mass und Farbe ist der Steckknopf den übrigen Drehknöpfen angepasst. Sämtliches Zubehör kann wie üblich verwendet werden.

Die Achsmasse sind den DIN- und MIL-Normen angepasst.

Erhältlich für folgende Achsen: 3 mm, 1/8", 4 mm, 6 mm, 1/4".

4 Knopfdurchmesser: ϕ 10, 15, 21, 28.

Vorteile der Steckknöpfe: preiswert, kurze Montagezeit, eindeutige Positionierung.

La gamme RITEL de boutons à enfoncer vient compléter la série existante de boutons à collet et est destinée en particulier aux grands consommateurs.

La construction, la dimension et la couleur sont adaptées aux boutons à collet et tous les accessoires peuvent également être utilisés.

Les dimensions d'axe sont adaptées aux normes DIN et MIL.

Disponibles pour axes 3 mm, 1/8", 4 mm, 6 mm, 1/4".

4 dimensions de boutons: ϕ 10, 15, 21 et 28 mm.

Avantages: prix modique, montage rapide, fixation claire.

The RITEL "push on" knob program is an enlargement of the existing collet knob program and especially made for large-scale consumers.

In its design, size and colour, the "push on" knob is adapted to the collet knob. All accessories can be used too.

The shaft dimensions are adapted to the DIN and MIL norms.

Available for shaft dia. 3 mm, 1/8", 4 mm, 6 mm, 1/4".

4 knob sizes: dia. 10, 15, 21 and 28. Advantages: low price, quick mounting, clear fixation.

Achsabmessungen

Dimensions d'axe

Shaft dimensions

DIN-Norm/Norme DIN/DIN norm		MIL-Norm/Norme MIL/MIL norm	
Achsdurchmesser ϕ axe shaft dia.	Abflachung plat flattened	Achsdurchmesser ϕ axe shaft dia.	Abflachung plat flattened
3 mm	2 - $\frac{0}{0.1}$ mm	1/8"	2,39 mm (0.094 inch)
4 mm	3 - $\frac{0}{0.1}$ mm	1/4"	5,49 mm (0.216 inch)
6 mm	4 - $\frac{0}{0.1}$ mm		

Lieferbare Achsdurchmesser

Diamètres d'axe en stock

Shaft dia. in stock

Achsdurchmesser ϕ axe shaft dia.	Knopfdurchmesser ϕ bouton knob dia.			
	10	15	21	28
3	●			
1/8"	●	●		
4	●	●	●	
6		●	●	●
1/4"		●	●	●

Die schraffierten Achsdurchmesser sind nur auf Bestellung erhältlich. Lieferzeit ca. 4 Wochen.

Les diamètres d'axe hachurés sont disponibles sur demande spéciale. Délai de livraison: quatre semaines environ.

The hatched shaft dia. are available on demand only. Delivery time: about 4 weeks.

Wir sind auch in der Lage, andere Achsmasse oder Achsausführungen (z. B. gezahnt) kurzfristig herzustellen.

Nous sommes également à même de fournir d'autres dimensions d'axe ou types différents (moletés par exemple), à bref délai.

We are also able to produce other shaft dimensions or shaft types (e.g. rimmed) in short time.



hellgrau
gris clair
light grey



schwarz
noir
black



hellgrau
mit Linie
gris clair
avec trait
light grey
with line



schwarz
mit Linie
noir
avec trait
black
with line

10 mm

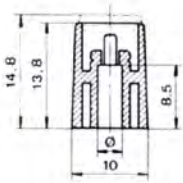

Ø

3	76 10 30 1	76 10 30 3	77 10 30 1	77 10 30 3
1/8	76 10 31 1	76 10 31 3	77 10 31 1	77 10 31 3
4	76 10 40 1	76 10 40 3	77 10 40 1	77 10 40 3

15 mm

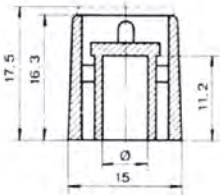

Ø

1/8	76 15 31 1	76 15 31 3	77 15 31 1	77 15 31 3
4	76 15 40 1	76 15 40 3	77 15 40 1	77 15 40 3
6	76 15 60 1	76 15 60 3	77 15 60 1	77 15 60 3
1/4	76 15 61 1	76 15 61 3	77 15 61 1	77 15 61 3

21 mm

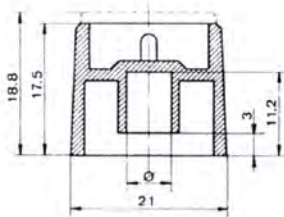

Ø

4	76 21 40 1	76 21 40 3	77 21 40 1	77 21 40 3
6	76 21 60 1	76 21 60 3	77 21 60 1	77 21 60 3
1/4	76 21 61 1	76 21 61 3	77 21 61 1	77 21 61 3

28 mm

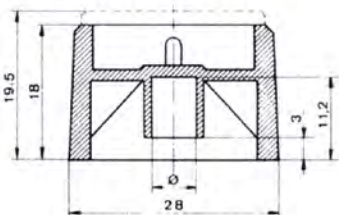

Ø

6	76 28 60 1	76 28 60 3	77 28 60 1	77 28 60 3
1/4	76 28 61 1	76 28 61 3	77 28 61 1	77 28 61 3



RITEL-Industrieklemmen

- Für 4 mm Steck- und Drahtanschluss (bis ϕ 2 mm)
- mit Verdrehungsschutz
- mit unverlierbarem Berührungsschutz
- montierbar bis Frontplattenstärke von 6 mm
- Kunststoffteile Polyamid

Pinces industrielles RITEL

- Pour connexion enfichable 4 mm et par fil (jusqu'à ϕ 2 mm)
- avec dispositif antirotatoire
- avec protection imperable contre les contacts accidentels
- montables sur des platines jusqu'à 6 mm
- parties plastiques en Polyamide

RITEL industrial terminals

- For 4 mm plug and wire connection up to 2 mm dia
- with locking device
- with captive insulation against electric shock
- can be fitted to front plates up to 6 mm thickness
- plastic parts in Polyamide

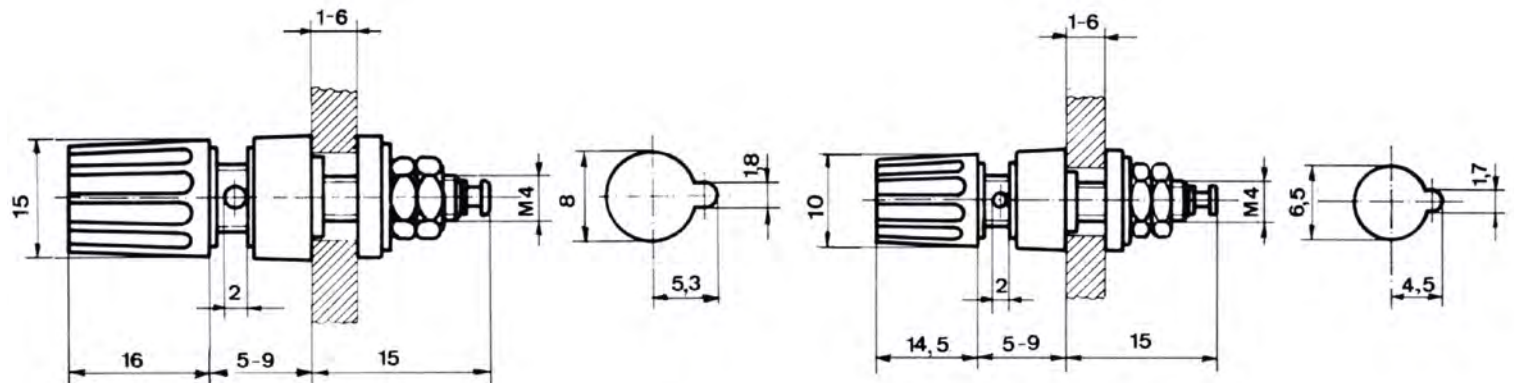

Technische Daten

	ϕ 15 mm	ϕ 10 mm
Dauerstrom:	25 Ampère	20 Ampère
Übergangsspannung:	2500 Volt	2500 Volt
Isolationswiderstand:	10^{13} Ohm	10^{13} Ohm
Kapazität:	6 pf	3 pf

Indications

	ϕ 15 mm	ϕ 10 mm
Courant permanent:	25 Ampère	20 Ampère
Tension de contournement:	2500 Volt	2500 Volt
Résistance d'isolement:	10^{13} Ohm	10^{13} Ohm
Capacité:	6 pf	3 pf

Technical Data

	ϕ 15 mm	ϕ 10 mm
Permanent current:	25 Ampère	20 Ampère
Contact voltage:	2500 Volt	2500 Volt
Insulationres:	10^{13} Ohm	10^{13} Ohm
Capacity:	6 pf	3 pf

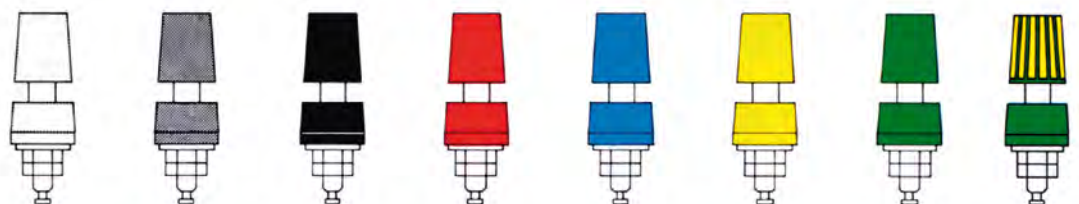

10 mm	standard	24 10 00 1	24 10 00 2	24 10 00 3	24 10 00 4	24 10 00 5	24 10 00 6	24 10 00 7	24 10 00 8
	mat finish	24 10 10 1	24 10 10 2	24 10 10 3	24 10 10 4	24 10 10 5	24 10 10 6	24 10 10 7	
15 mm	standard	24 15 00 1	24 15 00 2	24 15 00 3	24 15 00 4	24 15 00 5	24 15 00 6	24 15 00 7	24 15 00 8
	mat finish	24 15 10 1	24 15 10 2	24 15 10 3	24 15 10 4	24 15 10 5	24 15 10 6	24 15 10 7	

Japan	TECH TRUST JAPAN Co., LTD Glass City Moto-Yoyogi 30-13 Moto-yoyogi-cho Shibuya-ku Tokyo 151-0062 Japan	Phone: +81 3 5456 5730 Fax: +81 3 6369 4465 e-mail: international@tech-trust.co.jp web: www.tech-trust.co.jp
USA	POWER DYNAMICS INC. 145 Algonquin Parkway Whippany, NJ 07981 USA	Phone: +1 973 560 0019 Fax: +1 973 560 0076 e-mail: sales@powerdynamics.com web: www.powerdynamics.com
Belgium	VERCO s. p. r. l. Rue de Woeringen 9 1000 Bruxelles Belgique	Phone: +32 2 5124082 Fax: +32 2 5110353 e-mail: verco.sprl@skynet.be web: www.verco.be
Denmark	MIKKELSEN ELECTRONICS AS Havremarken 3-5 3520 Farum Denmark	Phone: +45 44 34 03 00 Fax: +45 44 34 03 10 e-mail: info@mi-ec.com web: www.mi-ec.com
Finland	FINNEKI OY Laitilankuja 5 00420 Helsinki Finland	Phone: +358 9 146 1211 Fax: +358 9 146 1527 e-mail: sales@finneki.fi web: www.finneki.fi
France	S.A.R.L. CSA ELECTRONICS 5 Eugene Dupuis Zone Europarc 94000 Créteil France	Phone: +33 148 92 49 25 Fax: +33 149 56 16 11 e-mail: corinne@csa-electronics.com web: www.csa-electronics.com
Germany	CONTRINEX GMBH Lötscher Weg 104 41334 Nettetal Deutschland	Phone: +49 2153 7374-0 Fax: +49 2153 7374-10 e-mail: info@contrinex.de web: www.contrinex.de
Italy	FACE TRADING s. r. l. Via Enrico Fermi, 20 20090 Cesano Boscone (MI) Italia	Phone: +39 02 4583050 Fax: +39 02 4503741 e-mail: info@facetradng.it web: www.facetrading.it
Netherlands	TEXIM Europe B.V. Elektrostraat 7 7483 PG Haaksbergen Netherlands	Phone: +31 53 5733 333 Fax: +31 53 5733 335 e-mail: info@texim-europe.com web: www.texim-europe.com
Norway	SKANDINAVISK ELEKTRONIKK A/S Nedre Hagavei 2150 Arnes Norway	Phone: +47 6390 7921 Fax: +47 6390 7922 e-mail: skand.elektro@online.no
Portugal	CDC LDA Beloura / Rua Pé de Mouro Centro Empresarial Lusoworld, 11 2710-335 Sintra Portugal	Phone: +351 219245988 Fax: +351 219245990 e-mail: info@cdcportugal.com web: www.cdcportugal.com
Sweden	EG ELECTRONICS AB Grimstagatan 160 162 11 Vällingby Sweden	Phone: +46 8 587 08800 Fax: +46 8 587 08802 e-mail: info@egruppen.com web: www.egelectronics.com
Switzerland	OMNI RAY AG Im Schörli 5 8600 Dübendorf Schweiz	Phone: +41 44 802 28 80 Fax: +41 44 802 28 28 e-mail: info@omniray.ch web: www.omniray.ch

Ritel Ltd.
Hauptstrasse 89
CH-9113 Degersheim/Switzerland
Tel. +41 (0)71 370 00 60
Fax +41 (0)71 370 00 62
www.ritel.ch
E-mail: info@ritel.ch