

## Toggle Switch

Version 03/16

Item no. 1426605

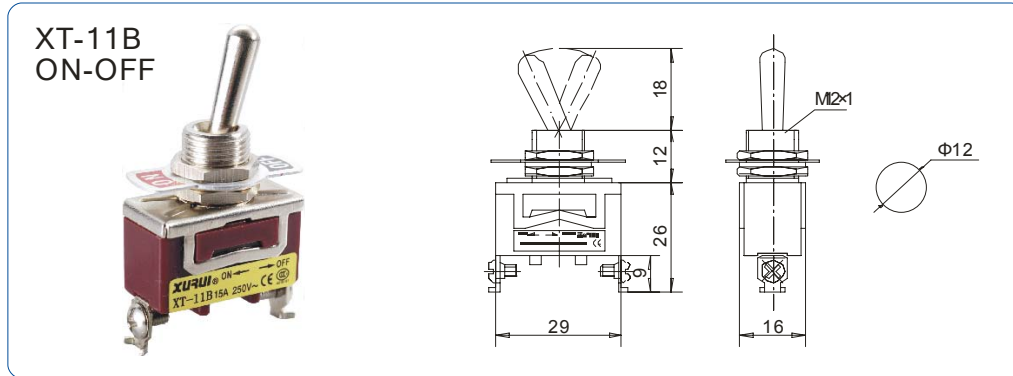

### Connection Diagram



1 Number of pins.....	2 pins
2 Housing Material.....	Thermoplastic cover
3 Actuator material and plating: Lever.....	copper, plating Nickel
4 Contact material and plating.....	silver contact
5 Tolerance ( Tolerance standard GB/T1804-m).....	>6-30/±0.2
6 Rating load.....	15A/250VAC
7 Contact resistance.....	25mΩ(initial value)
8 Insulation resistance.....	≥100MΩ(above)DC500V
9 Withstand voltage of Non-connection wire .....	1000VAC
10 Withstand voltage of Every terminal.....	1500VAC
11 Electrical life.....	100, 000 above
12 Mechanical life.....	500, 000 above
13 Operating temperature.....	-25~80 Celsius degrees.
14 Operating humidity.....	< 85 %

### Distributed by Conrad Electronic SE

This data sheet is a publication by Conrad Electronic SE, Klaus-Conrad-Str. 1, D-92240 Hirschau (www.conrad.com). All rights including translation reserved. Reproduction by any method, e.g. photocopy, microfilming, or the capture in electronic data processing systems require the prior written approval by the editor. Reprinting, also in part, is prohibited. This data represent the technical status at the time of printing. Changes in technology and equipment reserved.