

# INSTRUCTION MANUAL

Compact Photoelectric sensor **CX-400** series

Adjustable Range Reflective Type

## CX-44□

Thank you very much for using SUNX products. Please read this Instruction Manual carefully and thoroughly for the correct and optimum use of this product. Kindly keep this manual in a convenient place for quick reference.



- Never use this product as a sensing device for personnel protection.
- In case of using sensing devices for personnel protection, use products which meet standards, such as OSHA, ANSI or IEC etc., for personnel protection applicable in each region or country.

## 1 SPECIFICATIONS

Item	Type	NPN output		PNP output	
	Model No. (Note 1)	CX-441	CX-442	CX-441-P	CX-442-P
Adjustable range (Note 2)		20 to 50mm	40 to 300mm	20 to 50mm	40 to 300mm
Sensing range (with white non-glossy paper)		2 to 50mm	20 to 300mm	2 to 50mm	20 to 300mm
Hysteresis (with white non-glossy paper)		2% or less of operation distance	5% or less of operation distance	2% or less of operation distance	5% or less of operation distance
Repeatability		Along sensing axis: 1mm or less, Perpendicular to sensing axis: 0.2mm or less (with white non-glossy paper)			
Supply voltage		12 to 24V DC ±10% Ripple P-P 10% or less			
Power consumption		25mA or less			
Output		NPN open-collector transistor		PNP open-collector transistor	
		<ul style="list-style-type: none"> <li>• Maximum sink current: 100mA</li> <li>• Applied voltage: 30V DC or less (between output and 0V)</li> <li>• Residual voltage: 1V or less (at 100mA sink current) 0.4V or less (at 16mA sink current)</li> </ul>		<ul style="list-style-type: none"> <li>• Maximum source current: 100mA</li> <li>• Applied voltage: 30V DC or less (between output and +V)</li> <li>• Residual voltage: 1V or less (at 100mA source current) 0.4V or less (at 16mA source current)</li> </ul>	
Output operation		Switchable either Detection-ON or Detection-OFF			
Short-circuit protection		Incorporated			
Response time		1ms or less			
Operation indicator		Orange LED (lights up when the output is ON)			
Stability indicator		Green LED (lights up under stable operating condition)			
Distance adjuster		5-turn mechanical adjuster			
Sensing mode		BGS/FGS function Switchable with wiring of sensing mode selection input			
Automatic interference prevention function		Incorporated (Note 3)			
Protection		IP67 (IEC)			
Ambient temperature		-20 to +55°C (No dew condensation or icing allowed), Storage: -25 to +70°C			
Ambient humidity		35 to 85% RH, Storage: 35 to 85% RH			
Emitting element		Red LED (modulated)			
Material		Enclosure: PBT, Front cover: Polycarbonate, Display cover: Polycarbonate			
Cable		0.2mm <sup>2</sup> 4-core cabtyre cable, 2m long			
Weight		55g approx.			

Notes: 1) The model No. with suffix '-Z' is M8 plug-in connector type.

(Example): **CX-441-P-Z**

For the M8 plug-in connector type, use the following mating cables.

**CN-24A-C2** (Straight type, 4-core, cable length 2m) **CN-24AL-C2** (Elbow type, 4-core, cable length 2m)

**CN-24A-C5** (Straight type, 4-core, cable length 5m) **CN-24AL-C5** (Elbow type, 4-core, cable length 5m)

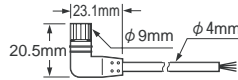
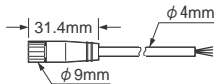

2) The adjustable range stands for the maximum sensing range which can be set with the distance adjuster.

3) The detection may be unstable depending on the mounting conditions or the sensing object to be used. In the state that this product is mounted, be sure to check the operation with the actual sensing object to be used.

## 2 MOUNTING

- The tightening torque should be 0.5N·m or less.

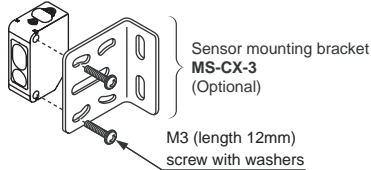

- Care must be taken regarding the sensor mounting direction with respect to the object's direction of movement.

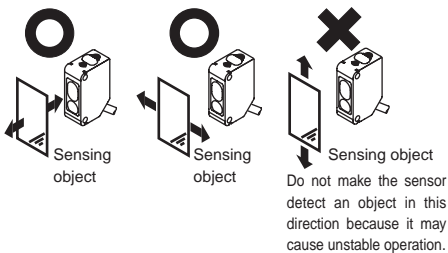

- When detecting a specular object (aluminum or copper foil, etc.) or an object having a glossy surface or coating, please take care that there are cases when the object may not be detected due to a small change in angle, wrinkles on the object surface, etc.

- When a specular body is present below the sensor, use the sensor by tilting it slightly upwards to avoid wrong operation.

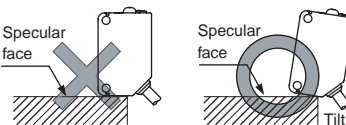

- If a specular body is present in the background, wrong operation may be caused due to a small change in the angle of the background body. In that case, install the sensor at an inclination and confirm the operation with the actual sensing object.
- Take care that there is a non-detectable area right in front of the sensor.

## 3 CAUTIONS

- Make sure that the power supply is off while wiring and adjusting.
- Take care that wrong wiring will damage the sensor.
- Verify that the supply voltage variation is within the rating.
- If power is supplied from a commercial switching regulator, ensure that the frame ground (F.G.) terminal of the power supply is connected to an actual ground.

- In case noise generating equipment (switching regulator, inverter motor, etc.) is used in the vicinity of this product, connect the frame ground (F.G.) terminal of the equipment to an actual ground.
- Cable extension is possible up to total 100m with 0.3mm<sup>2</sup>, or more, cable. However, in order to reduce noise, make the wiring as short as possible.
- Do not run the wires together with high-voltage lines or power lines or put them in the same raceway. This can cause malfunction due to induction.
- Take care that the sensor is not directly exposed to fluorescent light from a rapid-starter lamp or a high frequency lighting device, as it may affect the sensing performance.
- Do not use during the initial transient time (50ms) after the power supply is switched on.
- This sensor is suitable for indoor use only.
- A mechanical structure is employed for the distance adjuster of this product. Take care not to drop the product.
- Do not use this sensor in places having excessive vapor, dust, etc., or where it may come in direct contact with water, or corrosive gas.
- Take care that the sensor does not come in direct contact with water, oil, grease, or organic solvents, such as, thinner, etc.
- This sensor cannot be used in an environment containing inflammable or explosive gases.
- Never disassemble or modify the sensor.

## 4 I/O CIRCUIT DIAGRAMS

### ● NPN output type

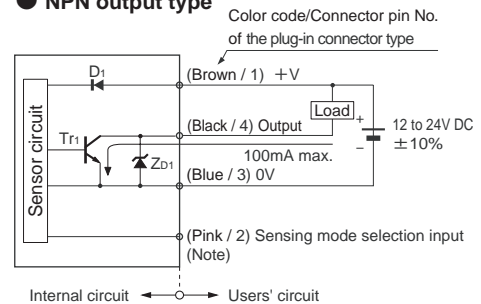

### ● PNP output type

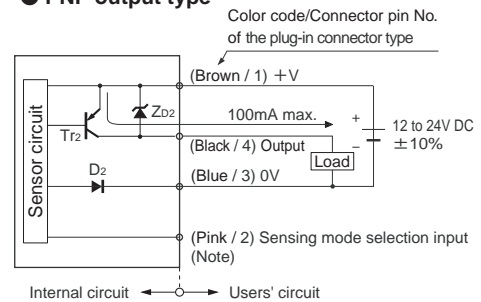

Symbols... D<sub>1</sub>, D<sub>2</sub> : Reverse supply polarity protection diode  
 Z<sub>D1</sub>, Z<sub>D2</sub> : Surge absorption zener diode  
 Tr<sub>1</sub> : NPN output transistor  
 Tr<sub>2</sub> : PNP output transistor

Note: The sensing mode (BGS/FGS function) can be selected by wiring of the sensing mode selection input (pink / 2). For details, refer to 'BGS/FGS FUNCTION'.

● Connector pin position (M8 plug-in connector type)

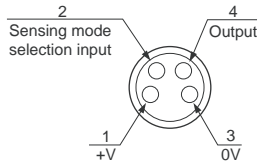

### 5 PART DESCRIPTION

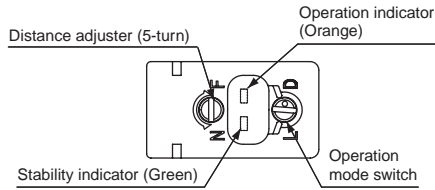

### 6 BGS/FGS FUNCTION

● This sensor incorporates BGS/FGS function. Select either BGS or FGS function depending on the positions of the background and sensing object. BGS/FGS function can be selected by wiring of the sensing mode selection input (pink / 2), as shown in the figure below.

Note: When this product is used, be sure to wire the sensing mode selection input (pink / 2).

<In case BGS function is used> <In case FGS function is used>

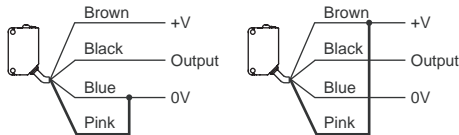

#### <BGS function>

• This function is used when the sensing object is apart from the background.

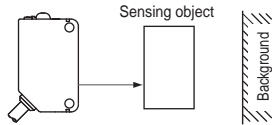

#### <FGS function>

• This function is used when the sensing object contacts the background or the sensing object is glossy, etc.

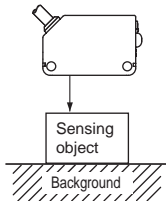

### 7 OPERATION MODE SWITCH

Operation mode switch	Description
	Detection-ON mode is obtained when the switch is turned fully clockwise. (L side)
	Detection-OFF mode is obtained when the switch is turned fully counterclockwise. (D side)

Note: Turn the distance adjuster gradually and lightly with a screwdriver (please arrange separately). If the operation mode switch is over turned or pressed heavily, it may be damaged.

● Depends on a selection of either BGS or FGS function, the output operation changes as follows.

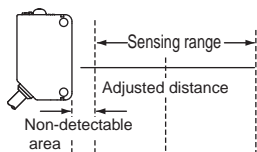

BGS	L-ON		ON
	D-ON		OFF
FGS	L-ON		ON
	D-ON		OFF

### 8 STABILITY INDICATOR

● Since the CX-44□ use a 2-segment photodiode as its receiving element, and sensing is done based on the difference in the incident beam angle of the reflected beam from the sensing object, the output and the operation indicator (orange) operate according to the object distance. Further, the stability indicator (green) shows the margin to the setting distance.

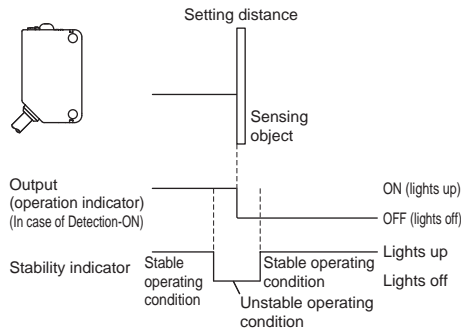

### 9 DISTANCE ADJUSTMENT

● When this product is used, be sure to carry out the distance adjustment.  
 ● Since the distance adjuster of this sensor is a 5-turn adjuster, when the point (A) and (B) is adjusted as explained in the table below, there may be more than 1 turn between the point (A) and (B). Therefore, make sure to remember the turns of both points to find the optimum position.  
 ● Be sure to wire the sensing mode selection input (Pink/2) before distance adjustment. If the wiring is done after the distance adjustment, the sensing area is changed.

● Turn the distance adjuster gradually and lightly with a screwdriver (please arrange separately). In order to protect itself, the distance adjuster idles if turned fully. If the adjuster is idled when distance adjustment is done, carry out the adjustment again.

● In case BGS function is used.

Step	Description	Distance adjuster
①	Turn the distance adjuster fully counterclockwise to the minimum sensing range position. (40mm approx., 20mm approx. for CX-441□)	
②	Place an object at the required distance from the sensor, turn the distance adjuster gradually clockwise, and find out point (A) where the sensor changes to the detecting condition.	
③	Remove the object, turn the adjuster clockwise further until the sensor goes into the undetecting state again. Once it has entered, turn the adjuster backward a little until the sensor returns to the undetecting condition. That position is designated as point (B). When the sensor does not go into the detecting condition even if the adjuster is fully turned clockwise, the position where the adjuster was fully turned is regarded as the point (B). There may be more than 1 turn between the point (A) and (B), since this sensor incorporates 5-turn adjuster.	
④	The optimum position to stably detect objects is the center point between (A) and (B).	

● In case FGS function is used.

Step	Description	Distance adjuster
①	Turn the distance adjuster fully clockwise to the maximum sensing range position. (300mm approx., 50mm approx. for CX-441□)	
②	In the state where the sensor detects the background, turn the distance adjuster gradually counterclockwise, and find out point (A) where the sensor changes to the undetecting condition.	
③	Place an object at the required distance from the sensor, turn the adjuster counterclockwise further until the sensor goes into the undetecting condition again. Once it has entered, turn the adjuster backward a little until the sensor returns to the detecting condition. That position is designated as point (B). When the sensor does not go into the undetecting condition even if the adjuster is fully turned counterclockwise, the position where the adjuster was fully turned is regarded as the point (B). There may be more than 1 turn between the point (A) and (B), since this sensor incorporates 5-turn adjuster.	
④	The optimum position to stably detect objects is the center point between (A) and (B).	

### 10 M8 PLUG-IN CONNECTOR TYPE

● Before connecting the M8 plug-in connector type (CX-44□-Z) with the optional connection cable for M8 plug-in connector type (CN-24A-C□, CN-24AL-C□), be sure to check the position of the connector pins on the sensor side connector and the connector of the connection cable. If those are connected improperly, the connector pins of the sensor may get damaged.

● In the condition where the sensing surface of the sensor is facing rightward, face the 'SUNX' logo marked on the connector to the front and connect them. (Refer to the figure below.)

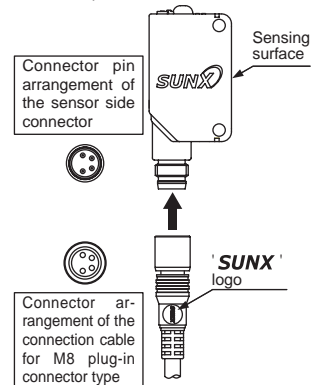

**SUNX Limited** <http://www.sunx.co.jp/>

#### Head Office

2431-1 Ushiyama-cho, Kasugai-shi, Aichi, 486-0901, Japan

Phone: +81-(0)568-33-7211 FAX: +81-(0)568-33-2631

#### Overseas Sales Dept.

Phone: +81-(0)568-33-7861 FAX: +81-(0)568-33-8591