

**Motor-protective circuit-breaker, 7.5 kW, 10 - 16 A, Screw terminals**



**Part no.** PKZM0-16  
**Catalog No.** 046938  
**Alternate Catalog No.** XTPR016BC1NL  
**EL-Nummer (Norway)** 4355147

**Delivery program**

|  |          |       |   |   |
|--|----------|-------|---|---|
| Product range  |          |       |   | PKZM0 motor protective circuit-breakers up to 32 A                  |
| Basic function   |          |       |   | Motor protection  |
|  |          |       |   |   |
| Notes  |          |       |   | Also suitable for motors with efficiency class IE3.                 |
| Connection technique   |          |       |   | Screw terminals   |
| Contact sequence   |          |       |   |   |
| <b>Max. motor rating</b>   |          |       |   |   |
| AC-3   |          |       |   |   |
| 220 V 230 V 240 V  | P        | kW    |   | 4   |
| 380 V 400 V 415 V  | P        | kW    |   | 7.5   |
| 440 V  | P        | kW    |   | 9   |
| 500 V  | P        | kW    |   | 9   |
| 660 V 690 V  | P        | kW    |   | 12.5  |
| Rated uninterrupted current  | $I_u$    | A     |   | 16  |
| <b>Setting range</b>   |          |       |   |   |
| Overload releases  |          | $I_r$ | A | 10 - 16   |
| short-circuit release  |          |       |   |   |
| max.   | $I_{rm}$ | A     |   | 248   |
| Phase-failure sensitivity  |          |       |   | IEC/EN 60947-4-1, VDE 0660 Part 102                                 |
| Explosion protection (according to ATEX 94/9/EC)   |          |       |   | PTB 10, ATEX 3013, Ex II(2) GD<br>Observe manual MN03402003Z-DE/EN. |
| <b>Notes</b> Overload trigger: tripping class 10 A<br>Can be snapped on to IEC/EN 60715 top-hat rail with 7.5 or 15 mm height. |          |       |   |   |

**Technical data**

|                     |  |    |  |  |
|---------------------|--|----|--|--|
| <b>General</b>      |  |    |  |  |
| Standards           |  |    |  | IEC/EN 60947, VDE 0660, UL, CSA  |
| Climatic proofing   |  |    |  | Damp heat, constant, to IEC 60068-2-78<br>Damp heat, cyclic, to IEC 60068-2-30 |
| Ambient temperature |  |    |  |  |
| Storage             |  | °C |  | - 40 - 80  |
| Open                |  | °C |  | -25 - +55  |
| Enclosed            |  | °C |  | - 25 - 40  |

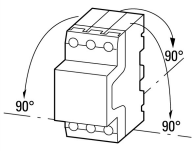
|   |  |                 |   |
|---|--|-----------------|---|
| Mounting position   |  |                 |  |
| Direction of incoming supply  |  |                 | as required   |
| Degree of protection  |  |                 |   |
| Device  |  |                 | IP20  |
| Terminations  |  |                 | IP00  |
| Protection against direct contact when actuated from front (EN 50274)     |  |                 | Finger and back-of-hand proof   |
| Mechanical shock resistance half-sinusoidal shock 10 ms to IEC 60068-2-27 |  | g               | 25  |
| Altitude  |  | m               | Max. 2000   |
| Terminal capacity main cable  |  |                 |   |
| Screw terminals   |  |                 |   |
| Solid   |  | mm <sup>2</sup> | 1 x (1 - 6)<br>2 x (1 - 6)  |
| Flexible with ferrule to DIN 46228  |  | mm <sup>2</sup> | 1 x (1 - 6)<br>2 x (1 - 6)  |
| Solid or stranded   |  | AWG             | 18 - 10   |
| Stripping length  |  | mm              | 10  |
| Specified tightening torque for terminal screws                           |  |                 |   |
| Main cable  |  | Nm              | 1.7   |
| Control circuit cables  |  | Nm              | 1   |

### Main conducting paths

|   |             |               |                           |
|---|-------------|---------------|---------------------------|
| Rated impulse withstand voltage                         | $U_{imp}$   | V AC          | 6000                      |
| Overvoltage category/pollution degree                   |             |               | III/3                     |
| Rated operational voltage                               | $U_e$       | V AC          | 690                       |
| Rated uninterrupted current = rated operational current | $I_u = I_e$ | A             | 16                        |
| Rated frequency   | f           | Hz            | 40 - 60                   |
| Current heat loss (3 pole at operating temperature)     |             | W             | 6.43                      |
| Impedance per pole                                      |             | mΩ            | 8                         |
| Lifespan, mechanical                                    | Operations  | $\times 10^6$ | 0.1                       |
| Lifespan, electrical (AC-3 at 400 V)                    |             |               |                           |
| Lifespan, electrical                                    | Operations  | $\times 10^6$ | 0.1                       |
| Max. operating frequency                                |             | Ops/h         | 40                        |
| Short-circuit rating                                    |             |               |                           |
| DC  |             |               |                           |
| Short-circuit rating                                    |             | kA            | 60                        |
| Notes   |             |               | up to 250 V               |
| Motor switching capacity                                |             |               |                           |
| AC-3 (up to 690V)                                       |             | A             | 16                        |
| DC-5 (up to 250V)                                       |             | A             | 16 (3 contacts in series) |

### Trip blocks

|   |  |              |  |
|---|--|--------------|--|
| Temperature compensation                              |  |              |  |
| to IEC/EN 60947, VDE 0660                             |  | °C           | - 5 ... 40                             |
| Operating range                                       |  | °C           | - 25 ... 55                            |
| Temperature compensation residual error for T > 40 °C |  |              | $\leq 0.25\%/K$                        |
| Setting range of overload releases                    |  | $\times I_u$ | 0.6 - 1                                |
| short-circuit release                                 |  |              | Basic device, fixed: $15.5 \times I_u$ |
| Short-circuit release tolerance                       |  |              | $\pm 20\%$                             |
| Phase-failure sensitivity                             |  |              | IEC/EN 60947-4-1, VDE 0660 Part 102    |

### Rating data for approved types

|                      |  |    |   |
|----------------------|--|----|---|
| Switching capacity   |  |    |   |
| Maximum motor rating |  |    |   |
| Three-phase          |  |    |   |
| 200 V<br>208 V       |  | HP | 3 |

|  |      |               |
|--|------|---------------|
| 230 V<br>240 V                                 | HP   | 5             |
| 460 V<br>480 V                                 | HP   | 10            |
| 575 V<br>600 V                                 | HP   | 10            |
| Single-phase                                   |      |               |
| 115 V<br>120 V                                 | HP   | 1             |
| 230 V<br>240 V                                 | HP   | 2             |
| Short Circuit Current Rating, type E           | SCCR |               |
| 240 V  | kA   | 42            |
| 480 Y / 277 V                                  | kA   | 42            |
| Accessories required                           |      | BK25/3-PKZ0-E |
| Short Circuit Current Rating, group protection | SCCR |               |
| 600 V High Fault                               |      |               |
| SCCR (fuse)                                    | kA   | 10            |
| max. Fuse                                      | A    | 150           |
| SCCR (CB)                                      | kA   | 10            |
| max. CB  | A    | 125           |
| SCCR with CL (fuse)                            | A    | 50            |
| max. Fuse (with CL)                            | A    | 600           |
| SCCR with CL (CB)                              | kA   | 50            |
| max. CB (with CL)                              | A    | 600           |

## Design verification as per IEC/EN 61439

| Technical data for design verification   |            |    |  |
|--|------------|----|--|
| Rated operational current for specified heat dissipation   | $I_n$      | A  | 16   |
| Heat dissipation per pole, current-dependent   | $P_{vid}$  | W  | 2.14   |
| Equipment heat dissipation, current-dependent  | $P_{vid}$  | W  | 6.43   |
| Static heat dissipation, non-current-dependent   | $P_{vs}$   | W  | 0  |
| Heat dissipation capacity  | $P_{diss}$ | W  | 0  |
| Operating ambient temperature min.   |            | °C | -25  |
| Operating ambient temperature max.   |            | °C | 55   |
| IEC/EN 61439 design verification   |            |    |  |
| 10.2 Strength of materials and parts   |            |    |  |
| 10.2.2 Corrosion resistance  |            |    | Meets the product standard's requirements.   |
| 10.2.3.1 Verification of thermal stability of enclosures   |            |    | Meets the product standard's requirements.   |
| 10.2.3.2 Verification of resistance of insulating materials to normal heat   |            |    | Meets the product standard's requirements.   |
| 10.2.3.3 Verification of resistance of insulating materials to abnormal heat and fire due to internal electric effects |            |    | Meets the product standard's requirements.   |
| 10.2.4 Resistance to ultra-violet (UV) radiation   |            |    | Meets the product standard's requirements.   |
| 10.2.5 Lifting   |            |    | Does not apply, since the entire switchgear needs to be evaluated.   |
| 10.2.6 Mechanical impact   |            |    | Does not apply, since the entire switchgear needs to be evaluated.   |
| 10.2.7 Inscriptions  |            |    | Meets the product standard's requirements.   |
| 10.3 Degree of protection of ASSEMBLIES  |            |    | Does not apply, since the entire switchgear needs to be evaluated.   |
| 10.4 Clearances and creepage distances   |            |    | Meets the product standard's requirements.   |
| 10.5 Protection against electric shock   |            |    | Does not apply, since the entire switchgear needs to be evaluated.   |
| 10.6 Incorporation of switching devices and components   |            |    | Does not apply, since the entire switchgear needs to be evaluated.   |
| 10.7 Internal electrical circuits and connections  |            |    | Is the panel builder's responsibility.   |
| 10.8 Connections for external conductors   |            |    | Is the panel builder's responsibility.   |
| 10.9 Insulation properties   |            |    |  |
| 10.9.2 Power-frequency electric strength   |            |    | Is the panel builder's responsibility.   |
| 10.9.3 Impulse withstand voltage   |            |    | Is the panel builder's responsibility.   |
| 10.9.4 Testing of enclosures made of insulating material   |            |    | Is the panel builder's responsibility.   |
| 10.10 Temperature rise   |            |    | The panel builder is responsible for the temperature rise calculation. Eaton will provide heat dissipation data for the devices. |

|                                     |  |  |
|-------------------------------------|--|--|
| 10.11 Short-circuit rating          |  | Is the panel builder's responsibility. The specifications for the switchgear must be observed.           |
| 10.12 Electromagnetic compatibility |  | Is the panel builder's responsibility. The specifications for the switchgear must be observed.           |
| 10.13 Mechanical function           |  | The device meets the requirements, provided the information in the instruction leaflet (IL) is observed. |

## Technical data ETIM 7.0

|   |    |  |
|---|----|--|
| Low-voltage industrial components (EG000017) / Motor protection circuit-breaker (EC000074)  |    |  |
| Electric engineering, automation, process control engineering / Low-voltage switch technology / Circuit breaker (LV < 1 kV) / Motor protection circuit-breaker (ecl@ss10.0.1-27-37-04-01 [AGZ529016]) |    |  |
| Overload release current setting  | A  | 16 - 16                                  |
| Adjustment range undelayed short-circuit release  | A  | 248 - 248                                |
| With thermal protection   |    | Yes                                      |
| Phase failure sensitive   |    | Yes                                      |
| Switch off technique  |    | Thermomagnetic                           |
| Rated operating voltage   | V  | 690 - 690                                |
| Rated permanent current I <sub>u</sub>  | A  | 16                                       |
| Rated operation power at AC-3, 230 V  | kW | 4  |
| Rated operation power at AC-3, 400 V  | kW | 7.5                                      |
| Type of electrical connection of main circuit   |    | Screw connection                         |
| Type of control element   |    | Turn button                              |
| Device construction   |    | Built-in device fixed built-in technique |
| With integrated auxiliary switch  |    | No                                       |
| With integrated under voltage release   |    | No                                       |
| Number of poles   |    | 3  |
| Rated short-circuit breaking capacity I <sub>cu</sub> at 400 V, AC  | kA | 50                                       |
| Degree of protection (IP)   |    | IP20                                     |
| Height  | mm | 93                                       |
| Width   | mm | 45                                       |
| Depth   | mm | 76                                       |

## Approvals

|                                      |  |  |
|--------------------------------------|--|--|
| Product Standards                    |  | IEC/EN 60947-4-1; UL 60947-4-1; CSA - C22.2 No. 60947-4-1-14; CE marking                 |
| UL File No.                          |  | E36332   |
| UL Category Control No.              |  | NLRV   |
| CSA File No.                         |  | 165628   |
| CSA Class No.                        |  | 3211-05  |
| North America Certification          |  | UL listed, CSA certified   |
| Specially designed for North America |  | No   |
| Suitable for                         |  | Branch circuit: Manual type E if used with terminal, or suitable for group installations |

## Characteristics

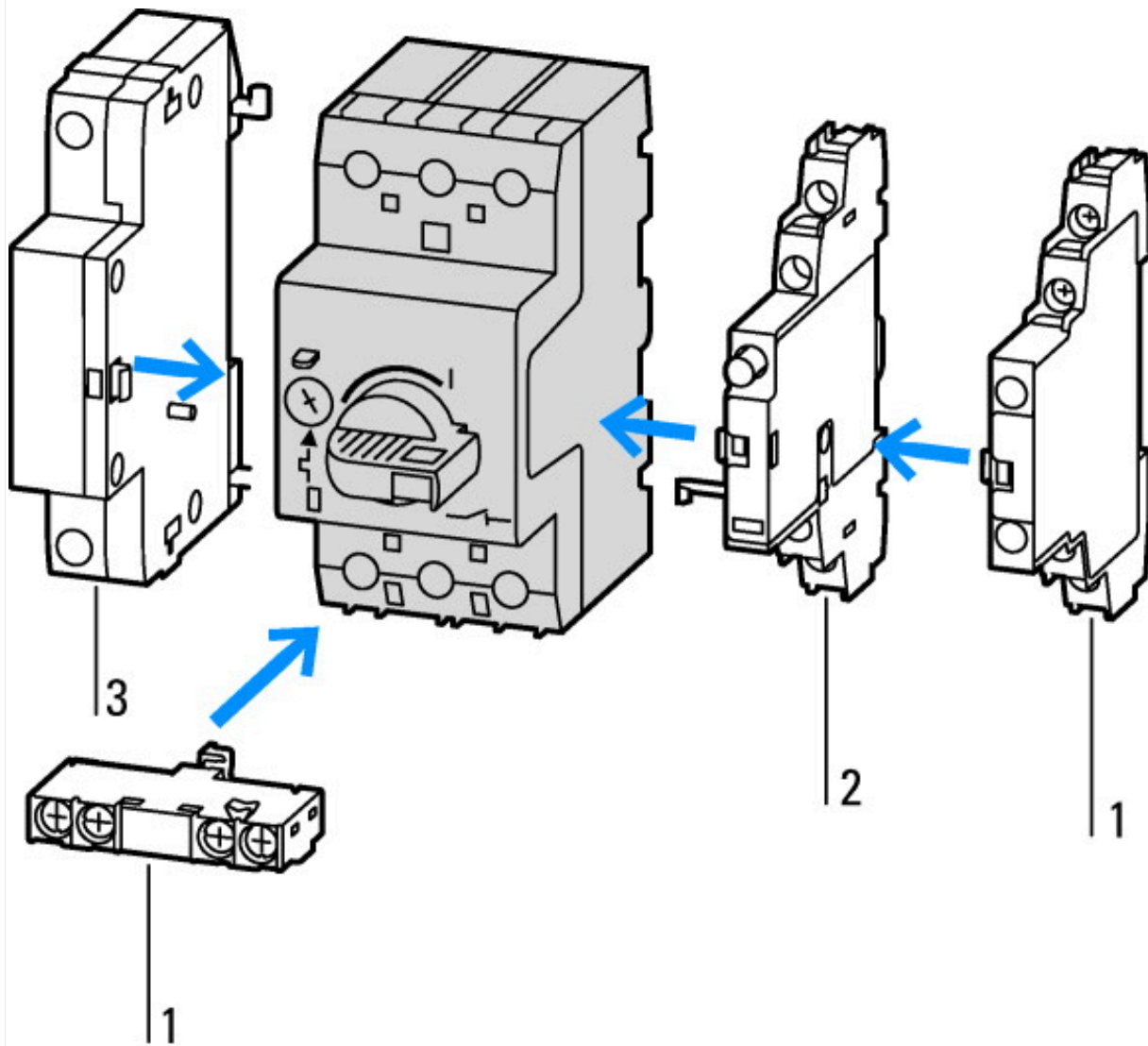

- 1: Standard auxiliary contact
- 2: Trip-indicating auxiliary contact
- 3: Shunt releases, undervoltage releases

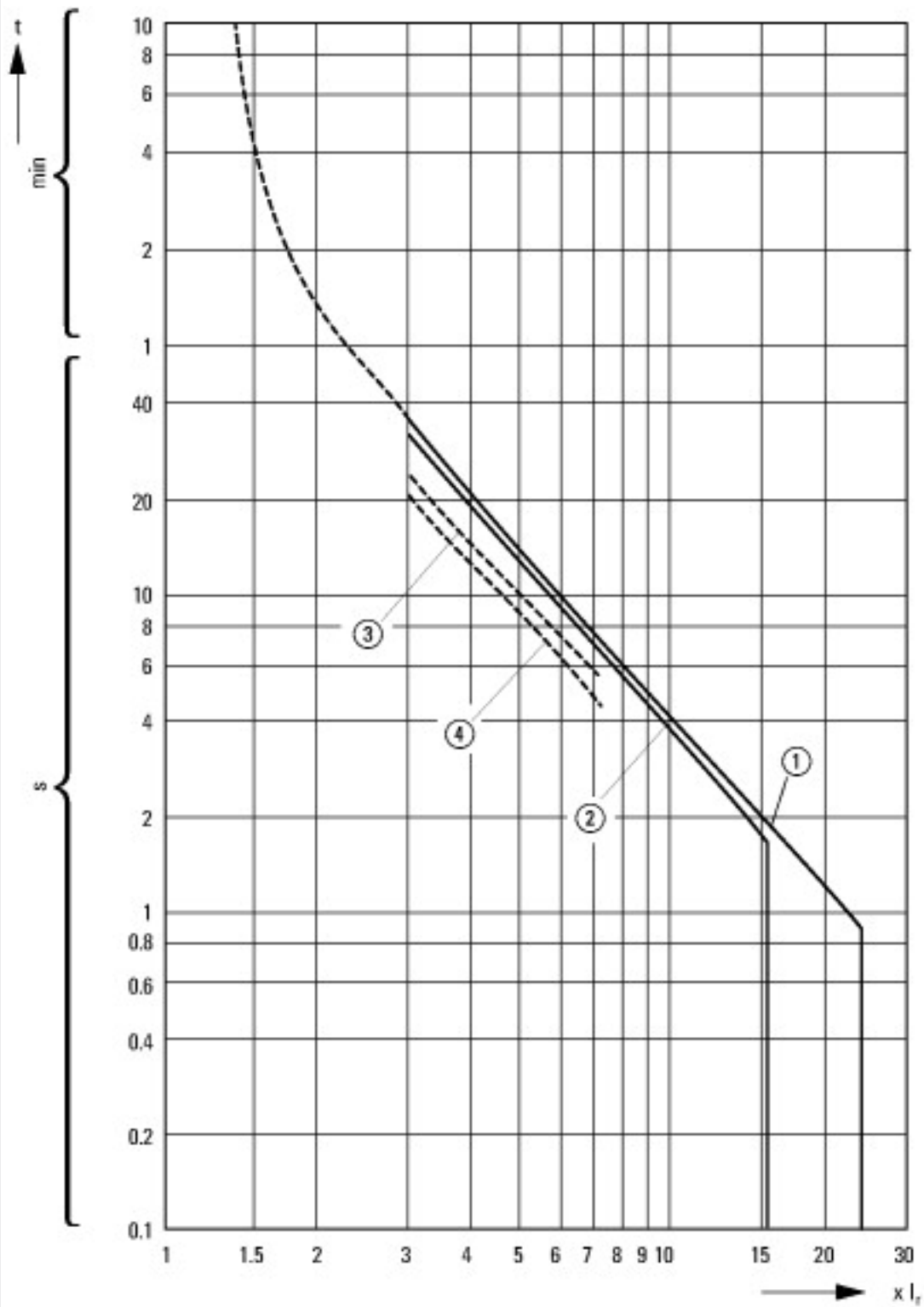

Tripping characteristics motor circuit breaker PKZM0-..., PKZM01

- 1: Minimum level, 3-phase
- 2: Maximum level, 3-phase
- 3: Minimum marker, 2-phase
- 4: Highest marker, 2-phase

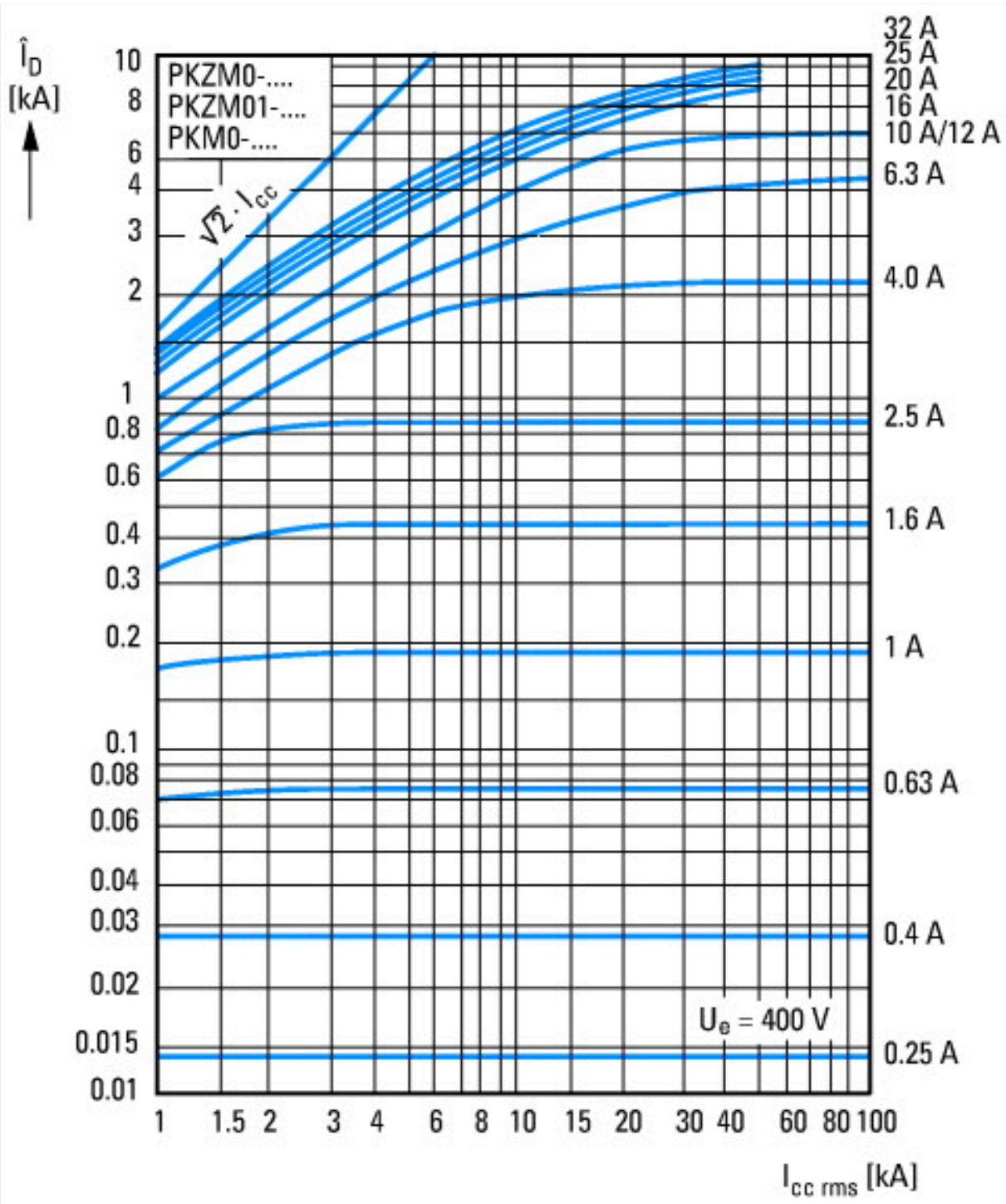

Let-through current



① 1 half-cycle  
Let-through energy



## Dimensions

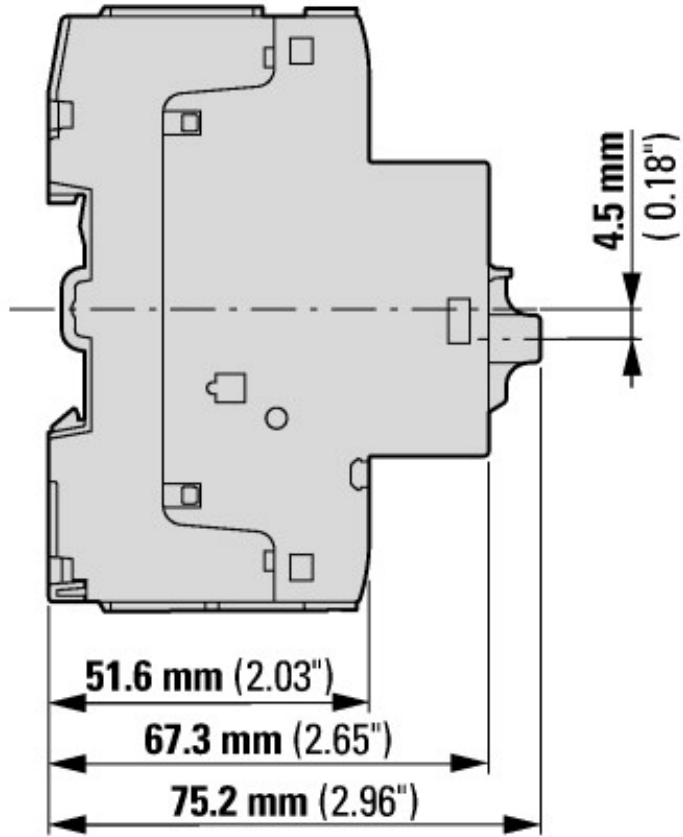
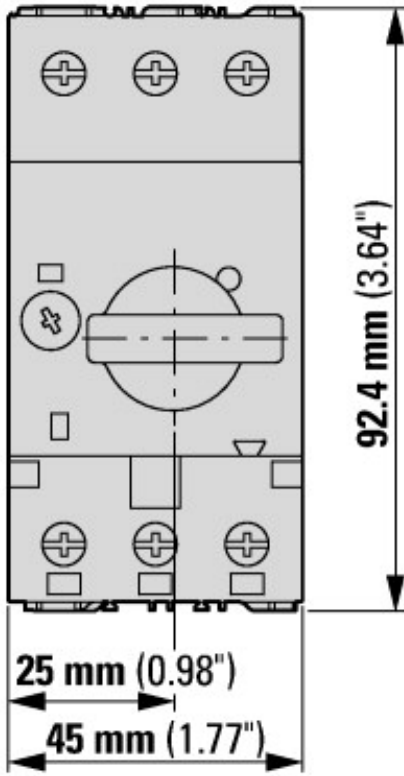

Motor-protective circuit-breaker with standard auxiliary contact  
 PKZM0-...(+NHI-E-...-PKZ0)  
 PKZM0-...-T(+NHI-E-...-PKZ0)  
 PKM0-...(+NHI-E-...-PKZ0)

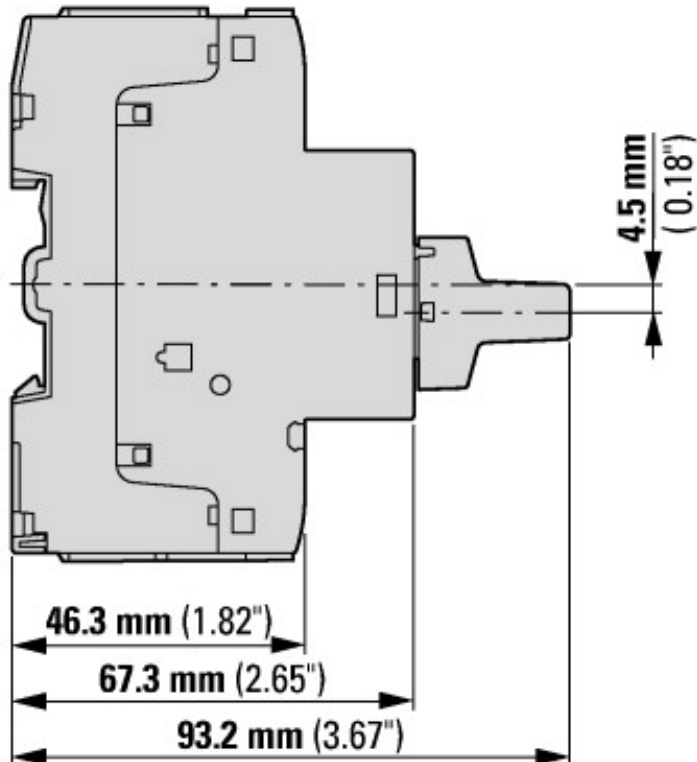
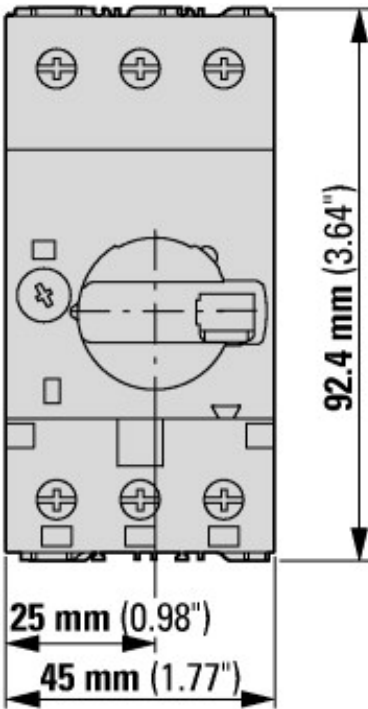

Motor-protective circuit-breakers with lockable rotary handles  
 PKZM0-...+AK-PKZ0

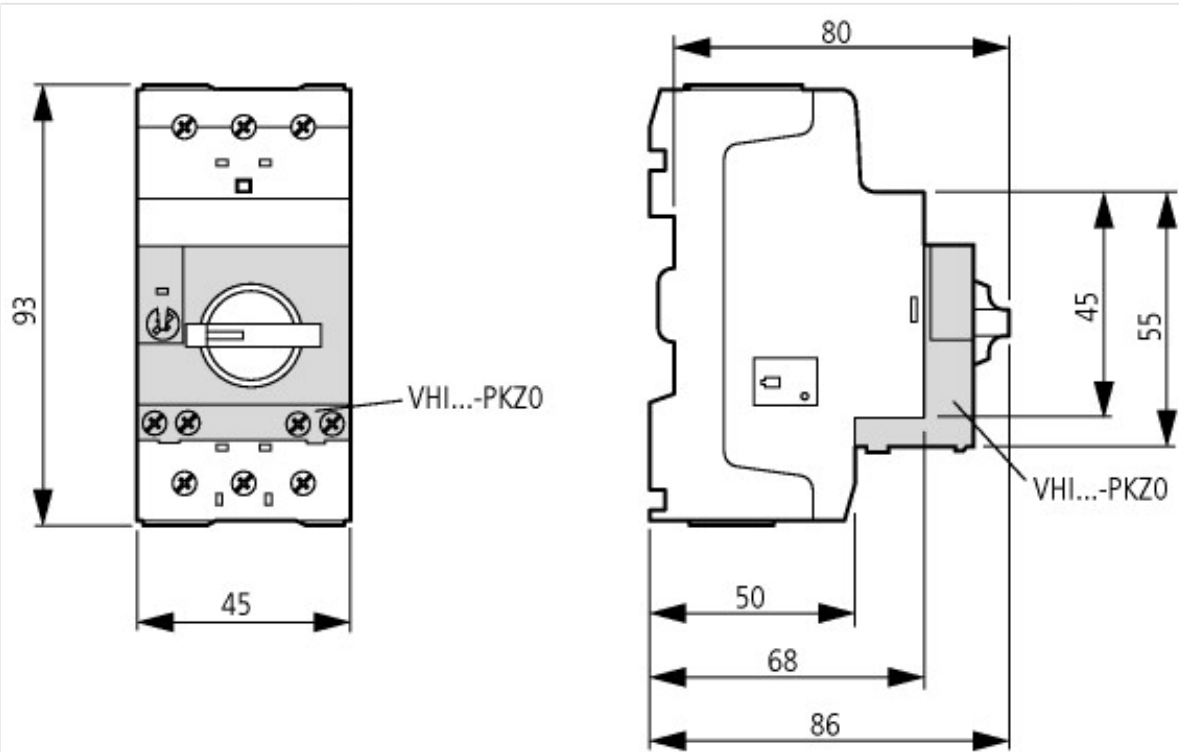

Motor-protective circuit-breakers with early-make auxiliary contacts  
 PKZM0-...+VHI-...-PKZ0