

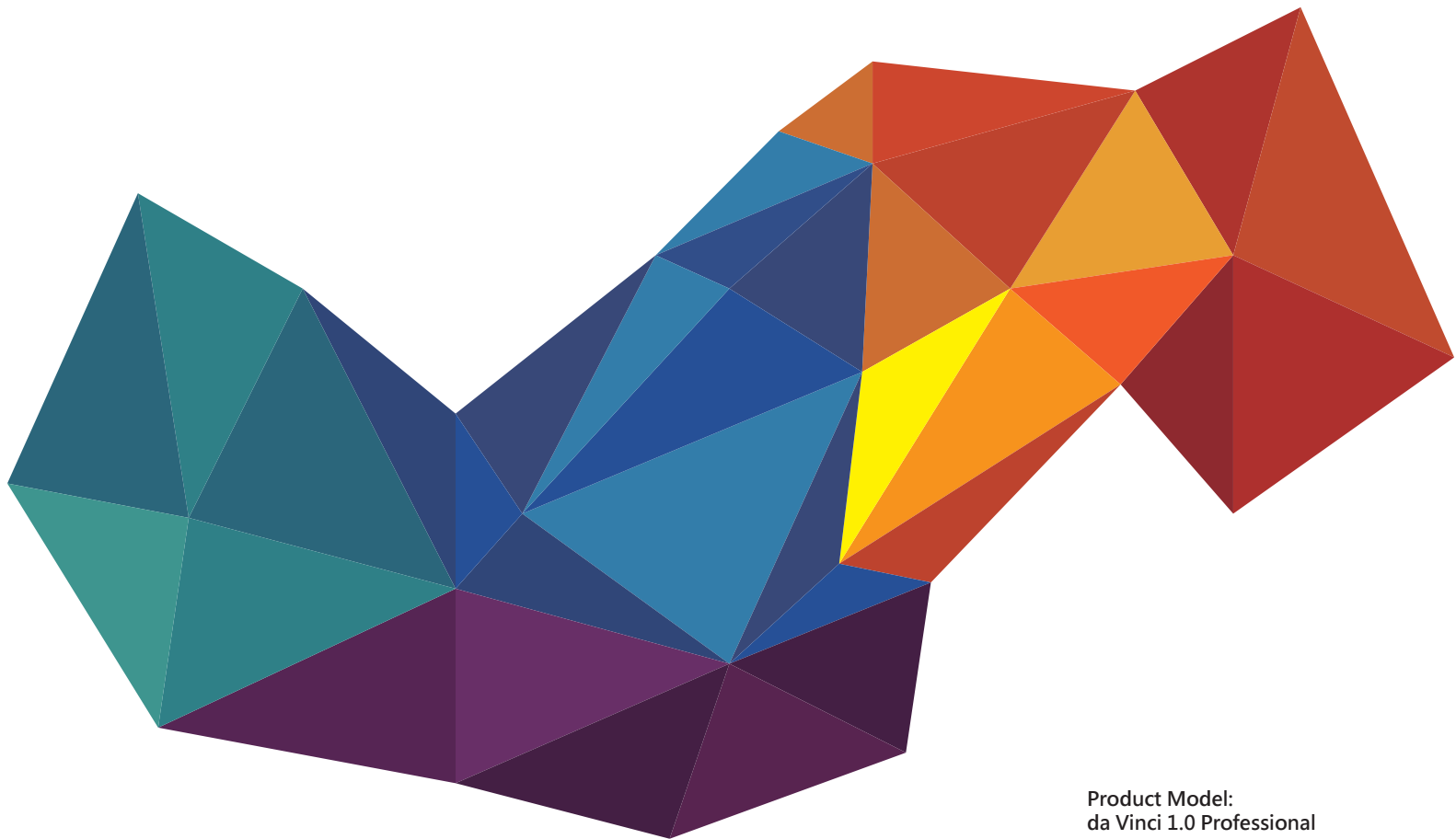

ENG

da Vinci 1.0 Pro User Manual

- ▶ Product Safety
- ▶ Product Description
- ▶ Printer screen menu, functions and messages
- ▶ Operation for Functions
- ▶ Print
- ▶ Support Details



Product Model:
da Vinci 1.0 Professional

The purpose of this user manual is to help users understand and use the da Vinci 1.0 Professional 3D printer correctly. It contains the operating instructions, maintenance information and application skills of the da Vinci 1.0 Professional 3D printer.

For the latest information about da Vinci 1.0 Professional 3D printer and XYZprinting products, please contact your sales representative or visit XYZprinting website: <http://www.xyzprinting.com>

Product Safety

● Safety and Compliance

Before you use, operate the product, change or remove any parts, components or materials of the product, or maintain the printer, please ensure that you carefully read this User Manual and the safety instructions described below, and strictly follow the instructions of such safety information.

The following warnings and attention notices are a best effort attempt to cover all scenarios; unfortunately it is not possible to do so in the case of performing maintenance procedures that are not described in this manual the burden of safety falls to the customer side.

● Important Safety Information



- Do not place the printer in humid or dusty environment such as bathrooms and high traffic areas.
- Do not place the printer on an unbalanced or unstable surface. Printer may fall or tumble causing harm and /or injury.
- Do not let children operate this device without adult supervision. Moving parts can cause serious injury.
- Please use the grounded power cord supplied with the printer to prevent a possible electrical shock.
- Insert and secure the power cord firmly for proper usage and to avoid potential electricity and fire dangers.
- Do not disassemble or replace the printer cover with none XYZprinting covers.
- Do not place any objects on top of the printer. Liquids and objects that fall into the printer can lead to printer damage or safety risks.
- Do not use flammable chemicals or alcohol wipes to clean this device.
- The process of heating the filament will produce a light non-toxic odor. Having a well ventilated area will ensure a more comfortable environment.
- Make sure to set the power switch to the off position and remove the power cord before transporting the device.
- Do not touch the interior of the print while printing as it may be hot and include moving parts.
- Some components of the printer are moving during operation. Do not attempt to touch or change anything inside before power off the printer.
- Do not attempt to service the printer beyond the instructions specified in this document. In the case of irrecoverable problem, contact XYZprinting service center or your sales representative.

● Trademarks

All trademarks and registered trademarks are the property of their respective owners.

Product Description

Product Overview



Auto Feed System

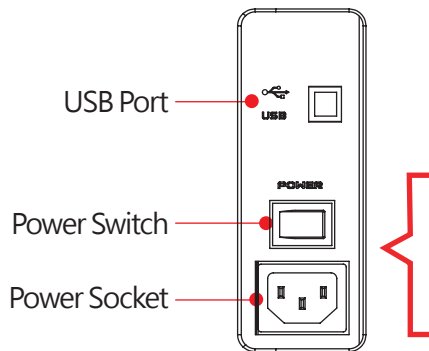
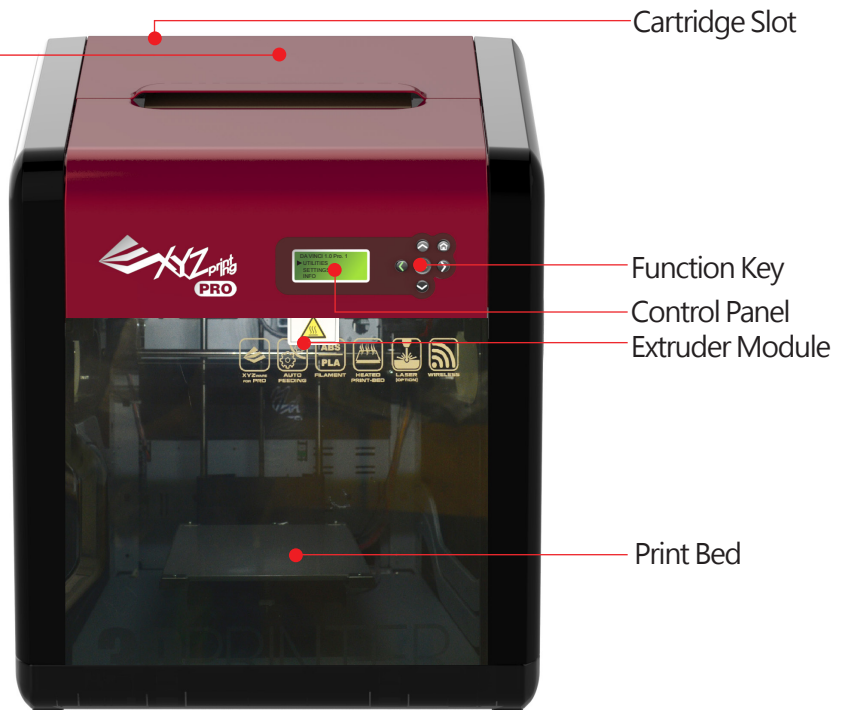

⚠ Levelness of the Print Bed may be susceptible to vibration during transportation, which may influence print quality. Please adjust the bed with reference to 「Print Bed Adjustment」 before printing.

Accessory Checklist

				Maintenance Tools
· Quick Guide, Warranty Card	· Filament Cartridge	· Cartridge Locker	· USB Cable	
· Software CD	· Side Cover Plate x2	· Bed Tape X 3pcs (The bed tape is reusable and it can be replaced when it's worn)	· Power Cord	

Operation for Functions

Open the box Note: Please removal all fixed materials before turning on the printer to prevent the machine from damage

<p>1 Open the box and remove the accessories and the cushion</p>	<p>2 Use the grip to take off the machine</p>	<p>3 Remove all fixing tapes and the packing bag</p>	
<p>4 Open the upper cover and remove fixities listed above</p> <p>Tape x2 Packing support x2 Cable tie x1</p>	<p>5 Remove 2 foams at the front of the cardboard</p>		
<p>Packing support x2 Tape x2 Cable tie x1</p> <p>! Pay attention particularly to actual paperboard removal of the fixities listed above</p>	<p>6 Remove the fixing styrofoam beside the bed</p>	<p>7 Remove fixing paperboard</p>	<p>8 Remove bottom screw and the fixing screw on the bottom of the bed</p>
<p>9 Pay attention particularly to actual removal of the fixities listed above</p>	<p>10 Pay attention particularly to actual removal of the fixities listed above</p>	<p>11 Insert the attached software CD into the computer and install print software according to instruction</p>	<p>12 Use the USB cable to connect the printer to PC. Connect the power cord to the printer then turn on the power switch</p> <p>"Note: Please use the power cord provided by XYZprinting."</p>

Important Safety Notes



- Do not use the printer in dust rich, highly humid or outdoor environments.
- Do not use the printer on a soft or tilt table to prevent the machine from falling, which may result in damage or personal injury.
- Do not put your hand into the machine during operation to avoid collision risk due to movement of the machine or to avoid burn due to high temperature.

Notes and Description for Use of Maintenance Tools



- The following tools can be used only in an environment with guidance or monitoring by adult. Do not allow children to obtain maintenance tools in unfamiliar situations in order to avoid danger.
- Please make sure to maintain the printer as the bed is cooled.



- After print is finished and the print bed is cooled to room temperature, the printing object may be taken off with Scraper.



- In order to prevent print quality from impact due to residual and accumulated filament, which results in poor discharge, after long-term use of print nozzle, it is recommended to enable the "CLEAN NOZZLE" (nozzle cleaning) function of the printer every 25 hours of print to clear residuals with nozzle cleaning wire.



- Filament residuals produced during print may also attach onto nozzle and gear of print module to influence print quality, printer operation, as well as measurement result of bed. For such situation, please use cooper brush to clean the print module.

● Maintenance and Service

If the printer is delivered for repair during warranty period, it is recommended to pack the machine with original packing materials before transportation. Therefore, please keep original packing materials. If other packing materials are used instead, the printer may be damaged during print process. In such situation, the XYZprinting the right to charge repair fee.

Display and Control Panel

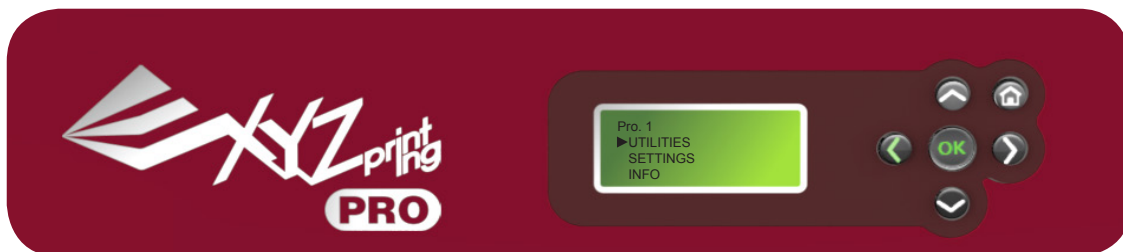

Direction Up / Decrease the value



Back to pervious menu /
Adjust the value /Move to
the preview item



Go to the next menu / Adjust
the value /Move to the next
item



Direction Down / Increase
the value



Select / Confirm setting /
Confirm and exit



Home menu

Printer screen menu, functions and messages

UTILITIES

Installation and removal of filament, calibration of the printing bed and printing settings, including:
 ♦ CHANGE CART ♦ HOME AXES ♦ Z OFFSET ♦ JOG MODE ♦ CALIBRATE ♦ BUILD SAMPLE
 ♦ CLEAN NOZZLE

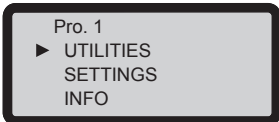

CHANGE CART

Load, unload filament and view the information about the filament. Using XYZprinting filament to ensure smooth operation of the machine is recommended.

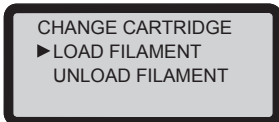
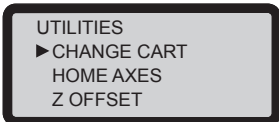

Refer to P.13 for Load filament
 Refer to P.15 for Unload filament

HOME AXES

Use the function to move the extruder to upper right corner of printing space and the print bed to the top.
 Extruder homing:

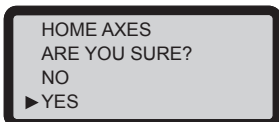

Select "YES" to return the extruder to the preset position.

Z OFFSET

Use the function to adjust the print bed upwards and downwards, and the printing distance between the bed and printing module.

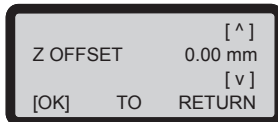
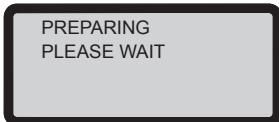
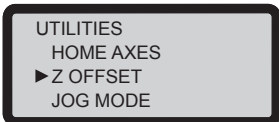

JOG MODE

Manually adjust the movement of X/Y/Z Axis for printer maintenance.

How to move the extruder:

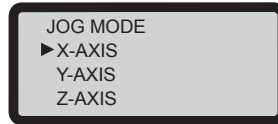
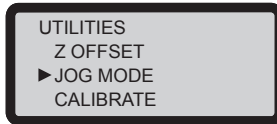

① Select a target to move:

- Select "X-AXIS" to move extruder rightwards and leftwards
- Select "Y-AXIS" to move extruder forwards and backwards
- Select "Z-AXIS" to move the print bed

② Adjust the distance

- Use "UP" and "DOWN" buttons to select the moving distance. Then, select "-" based on the desired distance and press the "TO THE LEFT" button or select "+" and press the "TO THE RIGHT" button to adjust the moving distance.
- Press the "TO THE LEFT" button: The extruder will be adjusted rightwards/backwards or closer to the print bed.
- Press the "TO THERIGHT" button: The extruder will be adjusted leftwards/forwards or away from the print bed.

CALIBRATE

Use the function to adjust the print bed and make adjustment based on the reference value. The printing quality will be affected by the levelness of the print bed. If you want to confirm the levelness of the print bed, turn on the function to measure and check recommended adjustment.

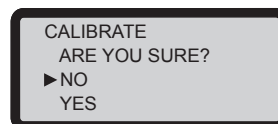
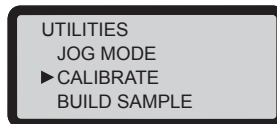

Refer to P.14 for CALIBRATE

BUILD SAMPLE

3 built-in samples are stored in the printer. You can learn to use the printer through building samples.

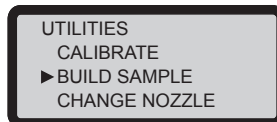

① Stick the bed tape onto the print bed before printing



② Select the built-in sample to be printed



③ Select "YES" and press "OK"

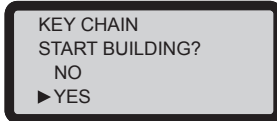

④ After completion of print, take off the print product. The print bed patch is reusable, replace the patch when it is worn out.

Note: Stick the bed tape onto the print bed before printing or apply some glue stick on the bed tape for objects with special structures to make the tape more adhesive and the object more difficult to remove.

CHANGE NOZZLE

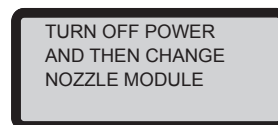
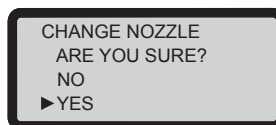
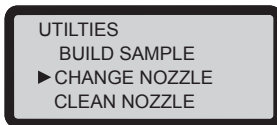

Turn off the printer after the printing device and print bed automatically move to their positions and change the printing module.



Levelness of the Print Bed may be susceptible to vibration during transportation, which may influence print quality. Please adjust the bed with reference to 「Print Bed Adjustment」 before printing.

Operation for Functions

- UTILITIES
- BUILD SAMPLE
- CHANGE NOZZLE
- ▶ CLEAN NOZZLE

Cleaning Way

● UTILITIES > CLEAN NOZZLE

Regular cleaning of the print nozzle facilitates to not only extending service life of the printer, but also improves print quality.

Enable "CLEAN NOZZLE" (nozzle cleaning) function. Clean the nozzle after the nozzle is heated up, the bed has been lowered and the extruder has been moved to the front end, and "READY FOR CLEAN" is displayed on screen.

1

Clean the detecting pin with Copper Brush
 Filament residues produced during printing may become attached to the nozzle and gear of print module to influence print quality, operation of the printer, and measurement result of the bed. If such a situation is encountered, please use a copper brush to clean the print module by brushing off residue and dirt on the detecting pin.

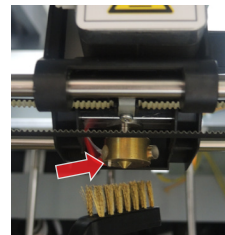

2

Clean Nozzle with Nozzle Cleaning Wire
 With increased print frequency, the carbon accumulation and dirt in the nozzle might affect print quality. Thus, we recommend you to clean nozzle for every **25 hours** of print. Please clamp the nozzle cleaning wire with needle-nosed pliers to insert it into the hone of the nozzle carefully for cleaning.

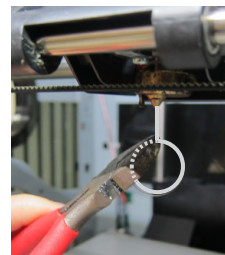

3

Wipe Measurement Points
 After the bed is lowered, please switch off power to cool the bed, followed by wiping 3 measurement points with damp cloth

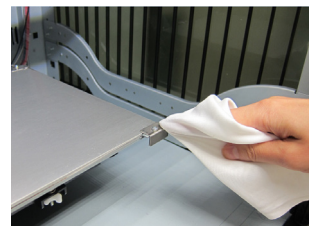

SETTINGS

The basic settings of the machine, functions, selection and adjustment of printing values, including:

- ◆ USER FILAMENT ◆ BUZZER ◆ AUTO HEAT ◆ LANGUAGE ◆ ENERGY SAVE ◆ RESTORE DEFAULT



USER FILAMENT

The user can customize the temperature of the extruder, print bed and unload filament based on the requirements of filament and designing objects.

NOZZLE

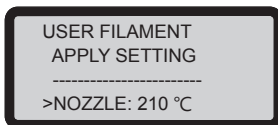

Print Bed

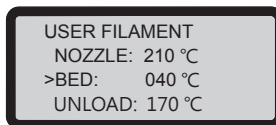

Filament Unloading

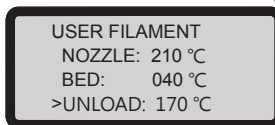

Refer to P.15 for Temperature Setting

BUZZER

When the buzzer is turned on, the printer will output an audible signal when a button is pressed, print job is finished, or issue is detected.

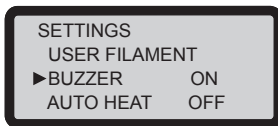

- Buzzer is turned on by default, you can select "OFF" and press "OK" to change the setting.

AUTO HEAT

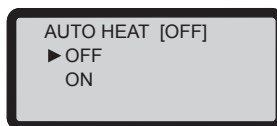
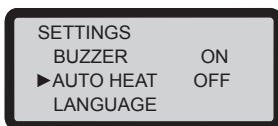

- When "AUTO HEAT" is turned on, the printer heats up the extruder and the print bed after powered on. This helps to shorten the idle time that is necessary to heat up the printer before printing.
- "AUTO HEAT" is off by default. you can select "ON" and "OK" to change the setting.

LANGUAGE

We suggest setting the language shown on the printer screen before use. The user can switch among English, Japanese, French, German, Italian and Spanish. English is the preset language. For other languages: Use "UP" and "DOWN" buttons to select the desired language and press "OK" to change setting.

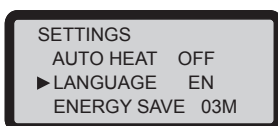

ENERGY SAVE

LED luminaries are installed in the printing chamber. To save energy consumed, the lighting will go off after idling for 3 minutes (shown as 03M on the display) by default.

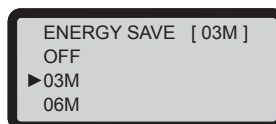
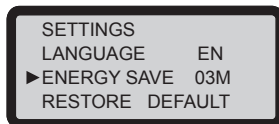

Select "06M" (for auto off after 6 minutes) or "OFF" (for never turn off the LED) and press "OK" to change the setting.

RESTORE DEFAULT

All settings can be reset to factory default with a few clicks.

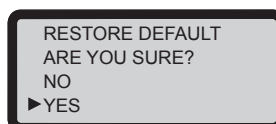
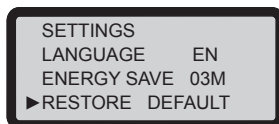

Select "YES" and press "OK" to reset all settings.

INFO

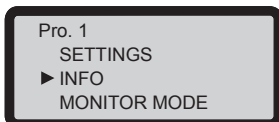

STATISTICS

Show the accumulated printing time and the last printing time. If you want to exit, press "OK" .

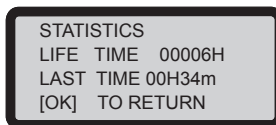
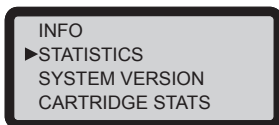

SYSTEM VERSION

Show the version information of the current firmware. We suggest upgrading printer firmware to the latest version to ensure steady quality. To check whether latest version of firmware is available, use XYZware. If you want to exit, press "OK" .

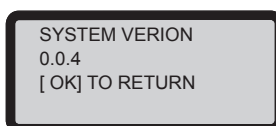
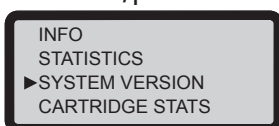

CARTRIDGE STATS

Show the remaining amount of filament (such as "REMAINING" for length information), volume of spool, color of filament and material information. Press to skip the page and press "OK" to exit.

INFO SYSTEM VERSION ▶CARTRIDGE STATS WIFO INFO	CARTRIDGE STATS REMAINING 240m CAPACITY 240m [DOWN] NEXT PAGE	COLOR RED [DOWN] NEXT PAGE	MATERIAL ABS [OK] TO RETURN
---	---	-----------------------------------	------------------------------------

WIFI INFO

It shows the current situation of the WiFi connection of the printer.
Refer to P.14 for "XYZware for Pro" WiFi Setting

INFO CARTRIDGE STATS ▶WIFO INFO HELP	INFO SYSTEM VERSION CARTRIDGE STATS ▶WIFI INFO	WIFI INFO NO CONNECTION [OK] TO RETURN
---	---	---

If there is connection, SSID of connected Wi-Fi, IP address, name of the connected printer and connection version will be shown. Press "OK" key.

WIFI (SSID) XYZ ▶[DOWN] NEXT PAGE	IP ADDRESS 192.168.40.38 [DOWN] NEXT PAGE	PRINTER NAME xyzprinting [DOWN] NEXT PAGE	WIRELESS VER. 5.1.5 [OK] TO RETURN
--	--	--	---

HELP

You may go to the website for the latest information, product documents, tutorial video and more. If you want to exit, press OK.

INFO CARTRIDGE STATS WIFO INFO ▶HELP	HELP www.xyzprinting.com ▶[OK] TO RETURN
---	---

Operation for Functions

Install and Load Filament UTILITIES > CHANGE CART > LOAD FILAMENT

● Install Filament Cartridge from XYZprinting



◆ Remove the filament stopper and tape and install the filament cartridge into the empty slot

◆ Place and push to click the cartridge

● Install Compatible filament

◆ Please erect filament spool by yourself °

◆ If you use your own filament, please make sure no cart in the tray or remove the cart if any

◆ Insert filament into the guide hole until the printer starts to load filament.
 ◆ Press the release arm to facilitate replacement and installation of filament
 ◆ Then, **activate LOAD FILAMENT function on the printer**

Activate LOAD FILAMENT function on the control panel

CHANGE CARTRIDGE >LOAD FILAMENT

● If select XYZprinting filament and setting preference, select "YES"



- A. Wait for the extruder to heat up
- B. As the temperature reaches operating setting the printer loads automatically the filament, and filament loading is completed
- C. Check if filament flows out from the nozzle. If the filament has flowed out, please press "OK"

● If setting preference by manually, select "NO"

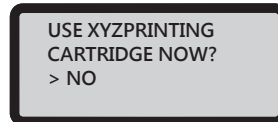

After selecting "USER FILAMENT" and pressing "OK" key, the operating temperatures for heating up procedures may be set, respectively. After adjusting to appropriate temperatures, return to the previous page and select "APPLY SETTING" to save settings, such that customized temperatures may be applied

Remarks: The temperature setting in this procedure is applicable only to 3D Builder application software developed by Microsoft. For more information about 3D Builder, please visit the Microsoft website

Filament loading is completed

Note : Before pushing the filament into the guide hole, please cut the tip of the filament off at a 45°

Operation for Functions

Unloading Filament

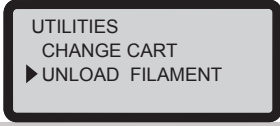

● UTILITIES > CHANGE CART > UNLOAD FILAMENT

In unloading filament, activating the filament unloading function on the control panel of the printer

1. Wait for the extruder to heat up to operating temperature and unload the filament.
2. As "PULLOUT FILAMENT" is displayed on the screen, open the release arm and pullout the filament.

Temperature Setting



● SETTINGS > USER FILAMENT

The user may customize nozzle temperature, print bed temperature and filament unloading temperature in accordance with requirements of different filaments and design objects:

Select the item for temperature setting

1

A Nozzle

Press "OK" to enter temperature setting for nozzle

B Print Bed

Press "OK" to enter temperature setting for print bed

C Filament Unloading

Press "OK" to enter temperature setting for filament unloading

2 Temperature Customization:

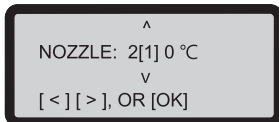

- Use "left key", "right key" to select the digit (single, tens, hundreds) for the temperature to be adjusted.
- Use "up key", "down key" to adjust value. The up key is for increasing value, and the down key is for decreasing value. Press "OK" key to apply setting.
- If your customized temperature exceeds allowable setting range, press "OK" and a setting range alert would be displayed.

3 Constraints of Customized Temperature Range

NOZZLE	Temperature elevation range of the extruder in feeding and printing: 170°C ~ 240°C
BED	Temperature elevation range of the print bed: 0°C ~110°C
UNLOAD	Temperature elevation range of the extruder in unloading: 170°C ~240°C

Remarks: The temperature setting in this procedure is applicable only to 3D Builder application software developed by Microsoft. For more information about 3D Builder, please visit the Microsoft website

Parameters Description

Transfer print file through computer software XYZware for Pro

Connect the printer and the computer with USB cable and install XYZware for Pro in the computer to transfer print file.

- A** — Import .stl, .3w files
- B** — Convert to .3w file
- C** — Save .stl file
- D** — Set print preference, transfer print file
- E** — Set software display language, preview color
- F** — Query, update software and firmware versions, open link to official website
- G** — Adjust display scale
- H** — Switch preview angle rapidly
- I** — Move location of the model
- J** — Change angle of the model
- K** — Adjust size of the model
- L** — Display information about the model
- M** — Delete the model from the virtual platform
- N** — Check printer temperature, filament information and print progress

XYZware for Pro may run in Windows 7 and above and Mac OS 10.8 and above operating systems. You may install it with the attached original vendor CD or download the installation file from the XYZprinting official website.

For more information, please visit the official website: <http://www.xyzprinting.com/>

● Basic Operation Flow

After opening the software, click "Import" to select the model file you desire to print and load it. The user may change relevant settings through "File Conversion" function to satisfy adjustment of print speed and effect.

After edition and adjustment, "Print" may be click to export object, and start to print after the file has undergone slicing process

For messages about version updates, operation instructions and technical support, please visit the XYZprinting official website: <http://www.xyzprinting.com/> to obtain more detailed information.

Parameters Description

WiFi Connection

The printer supports Wi-Fi connection printing.

Install XYZware for Pro, and activate Wi-Fi setting of the printer in accordance with the following instruction to switch the printer to wireless control mode, such that the print file may be subsequently transferred wirelessly.

● Preparation Prior to Setting

1. The network print function is provided mainly for Intranet application. Please set the printer and the computer in the same domain, that is, link them to the same wireless base station (Access Point)
2. Before linking the printer, settings would be adjusted for the connected wireless base station. For detailed setting way, please refer to the operation instruction of the product or original vendor relevant information.
3. Channel Width may be set to **20 MHz** for use of wireless print function. Please refer to original vendor operating instruction of wireless base station to understand adjustment way
4. Please keep the wireless network function in the on state
5. The machine supports the following link security modes. Public key information would be requested to enter in setting printer connection

◆ WEP

◆ WPA

◆ WPA2

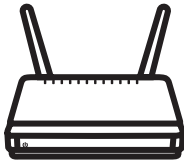

● Wi-Fi Settings

1

Please use a USB cable to link the computer and the printer, and open XYZware for Pro.



2

Click the "Printer Monitoring" function icon on the lower right corner on the screen, open "Printer Monitoring" window, click "My Printer" > "Scan" to enter the page for printer search, and click "Wireless Network Settings" to enter the page for wireless print settings.

2-1

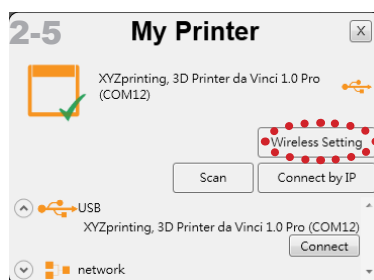
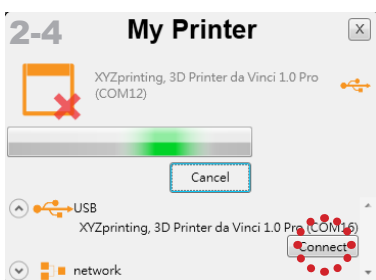
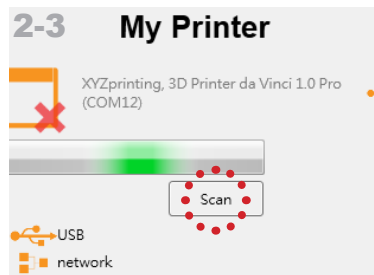
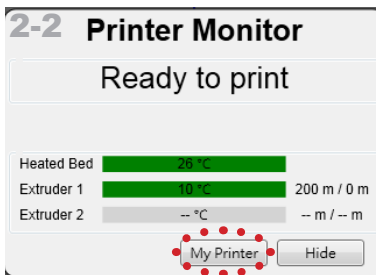
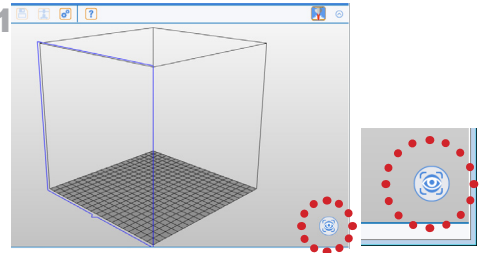

Parameters Description

WiFi Connection

3 Please enter printer name (either English or numeric name), press "Scan" function to obtain wireless base station information with dropdown menu, and select the name of the wireless network you desire to connect.



4 After successful connection, Wi-Fi name would be displayed on screen of the printer

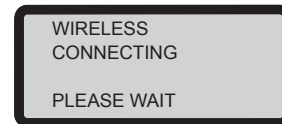

5 At this moment, USB cable may be taken off to continue the print process

6 If connection is to be disconnected, please connect USB back between the computer and the printer, and open XYZware for Pro again

Product Specification

Print Technology	Fuse Filament Fabrication (FFF)	Weight	26 KG
Print Dimension	20x20x20 cm	Print Material	ABS / PLA
Print Resolution	0.1 / 0.2 / 0.3 / 0.4 mm	Filament Diameter	1.75 mm
Display Screen	2.6 inch LCM	Nozzle Diameter	0.4 mm
Connection Method	USB 2.0 / WiFi	Operating System	Win 7 and above Mac OSX 10.8 and above
Print Software	XYZware for Pro	File Format	3w / stl

Print From A Mobile Application

- 1.The mobile device needs to support wireless printing.
- 2.Install XYZprinting App from Android or iOS system.

The screenshot shows the XYZprinting mobile application interface on an iPad. The top status bar displays 'iPad', signal strength, '13:33', and '75%' battery. The app header includes a 'User Information' icon (person) on the left and a 'Category' icon (printer) on the right. The main content area features a 'HAPPY CHILDREN'S DAY' banner with illustrations of a koala and an elephant. Below the banner are three sections: 'Most Popular' (Eiffel Tower, iPhone5保護殼, Skull, iPhone5, 骰子), 'New' (New Year TV, Happy New Year Taiwan, Snake, Garden shears stem, Massage), and 'Printable' (door stopper, ice keyboard_fixed, iphone 6 stand + 名片座, iphone 6 stand + 名片座, 朵朵花). The bottom navigation bar contains four icons: 'Gallery' (Main screen), 'My Upload' (Upload the item and printable file), 'Printer' (To remote control printer), and 'About' (Printer information and copyright).

● Step

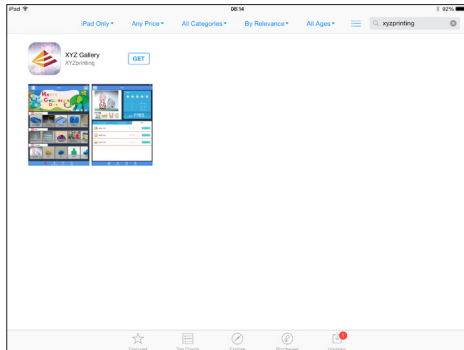

- 1 Open the Play Store from your Android browser or App store of iOS system to search "XYZgallery" and download the application to your device.
- 2 Please register an account at XYZprinting official website before logging in.

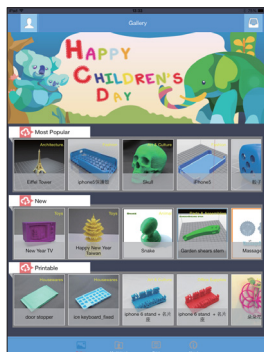

- 3 After log in, you will see " most popular" , "new" and "printable*" three folders for you to choose.
- 4 Select the object you want to print.

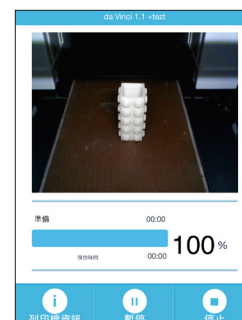

- 5 Select the printer and confirm the printer information, tap "Confirm to print", the file will be sent to the printer and ready to print.
- 6 You may remote control the printing status.

Note:

- 1.Ensure the mobile device and the printer are connected on the same wireless network.
- 2.Transferring a print file over a wireless network may take more time than transferring a print file from a USB mass storage device.
- 3. When a .3w file with incompatible slicing is selected, the message of "Printer Type does not match" will be displayed. We suggest selecting other files or downloading .stl to slice before printing.

*The printable file is .3w format which can print from App directly. Some prints are.stl files that need to export into .3w format via XYZware before printing. If the file requires payment, please follow the payment instruction.

Support Information

As the printer encounters issues, please refer to the following troubleshooting instruction to fix the issues. If the issue cannot be removed, please contact customer service center

Error message and Action

In the event of problems, related service code will be shown on the printer screen and/or software interface. Please refer to the description table of the service code for preliminary examination.

Service Code	Symptom	Action
0 0 0 3 (software)	Print bed heating problem	Confirm whether the heater works normally and whether the sensor and heating rod are installed correctly or work normally. Problems may occur when the printer works under 25 °C . Please move the printer to the environment at proper temperature.
0 0 0 7 (software)	"UNIDENTIFIED CARTRIDGE" shown on the printer screen indicates filament chip anomaly.	Reinstall or replace the filament cartridge.
0 0 0 8 (software)	"UNIDENTIFIED CARTRIDGE" shown on the printer screen indicates filament chip anomaly.	Reinstall or replace the filament cartridge.
0 0 1 0	Print bed heating problem	Confirm whether the heater works normally and whether the sensor and heating rod are installed correctly or work normally. Problems may occur when the printer works under 25 °C . Please move the printer to the environment at proper temperature.
0 0 1 1	Extruder heating problem	Confirm whether the nozzle works normally and whether the sensor and heating rod are installed correctly or work normally. Problems may occur when the printer works under 25 °C . Please move the printer to the environment at proper temperature.
0 0 1 3	Print bed heating problem	Confirm whether the heater works normally and whether the sensor and heating rod are installed correctly or work normally. Problems may occur when the printer works under 25 °C . Please move the printer to the environment at proper temperature.
0 0 1 4	Extruder heating problem	Confirm whether the nozzle works normally and whether the sensor and heating rod are installed correctly or work normally. Problems may occur when the printer works under 25 °C . Please move the printer to the environment at proper temperature.
0 0 2 8 (software)	NO CARTRIDGE (Filament is not installed correctly)	Reload or replace the filament
0 0 2 9 (software)	CARTRIDGE EMPTY	Replace filament immediately
0 0 3 0	X-axis movement abnormalities	Check motor/sensor connections. Check sensor position.
0 0 3 1	Y-axis movement abnormalities	Check motor/sensor connections. Check sensor position.
0 0 3 2	Z-axis movement abnormalities	Check motor/sensor connections. Check sensor position.
0 0 5 0	Internal storage error	Reboot the printer
0 0 5 1	flash ram access error	Reboot the printer
0 0 5 2	Nozzle internal memory error	Please contact our Customer Service center

Support Information

Error Status	Recommended Process Ways
Printer is busy	Try again after current task is completed, and examine the information displayed on screen of the printer
Firmware of the printer cannot be updated	Check internet connection / Update firmware later
Filament is clogged	Unload filament and reload it, and clean nozzle, too
Filament cannot be loaded	Unload the filament and reload it
NO CARTRIDGE Filament is not installed correctly	Reload or replace the filament
CARTRIDGE EMPTY There is no residual filament prior to print: remain 0%	Replace filament immediately
FILAMENT LOW Filament residual is low: remain 30%	Replace filament as need
FILAMENT END There is not filament residual in printing: remain 0%	Replace filament immediately

Maintenance and Service

If the printer is delivered for repair during warranty period, it is recommended to pack the machine with original packing materials before transportation. Therefore, please keep original packing materials. If other packing materials are used instead, the printer may be damaged during print process. In such situation, the XYZprinting the right to charge repair fee.

Federal Communications Commission (FCC) Statement

You are cautioned that changes or modifications not expressly approved by the part responsible for compliance could void the user’s authority to operate the equipment.

This equipment has been tested and found to comply with the limits for a Class B digital device, pursuant to part 15 of the FCC rules. These limits are designed to provide reasonable protection against harmful interference in a residential installation. This equipment generates, uses and can radiate radio frequency energy and, if not installed and used in accordance with the instructions, may cause harmful interference to radio communications. However, there is no guarantee that interference will not occur in a particular installation. If this equipment does cause harmful interference to radio or television reception, which can be determined by turning the equipment off and on, the user is encouraged to try to correct the interference by one or more of the following measures:

- Reorient or relocate the receiving antenna.
- Increase the separation between the equipment and receiver.
- Connect the equipment into an outlet on a circuit different from that to which the receiver is connected.
- Consult the dealer or an experienced radio/TV technician for help.

XYZprinting is not responsible for any radio or television interference caused by using other than recommended cables and connectors or by unauthorized changes or modifications to this equipment. Unauthorized changes or modifications could void the user’s authority to operate the equipment.

This device complies with Part 15 of the FCC Rules. Operation is subject to the following two conditions: (1) this device may not cause harmful interference, and (2) this device must accept any interference received, including interference that may cause undesired operation.

This device complies with FCC radiation exposure limits set forth for an uncontrolled environment and it also complies with Part 15 of the FCC RF Rules. This equipment must be installed and operated in accordance with provided instructions and the antenna(s) used for this transmitter must be installed to provide a separation distance of at least 20 cm from all persons and must not be co-located or operating in conjunction with any other antenna or transmitter. End-users and installers must be provided with antenna installation instructions and consider removing the no-collocation statement.