



Security Tech Germany

Smartvest



User manual

You can find important information and FAQs about this and other products online at:

www.abus.com

Version 1.2

*English translation of the original German user manual.
Retain for future reference.*



Introduction

Dear Customer,

Thank you for purchasing this product.

This device complies with the requirements of the applicable EU directives. The declaration of conformity can be obtained from:

ABUS Security-Center GmbH & Co. KG
Linker Kreuthweg 5
86444 Affing
GERMANY

To ensure this condition is maintained and that safe operation is guaranteed, it is your obligation to observe this user manual.

Please read the entire user manual carefully before putting the product into operation, and pay attention to all operating instructions and safety information.

All company names and product descriptions are trademarks of the corresponding owner. All rights reserved.

If you have any questions, please contact your specialist installation contractor or specialist dealer.





Disclaimer

This user manual has been produced with the greatest of care. Should you discover any omissions or inaccuracies, please contact us in writing at the address provided above.

ABUS Security-Center GmbH does not accept any liability for technical and typographical errors, and reserves the right to make changes to the product and user manuals at any time and without prior warning.

ABUS Security-Center GmbH is not liable or responsible for direct or indirect damage resulting from the equipment, performance and use of this product. No guarantee is made for the contents of this document.

Explanation of symbols

	The triangular high voltage symbol is used to warn of the risk of injury or health hazards (e.g. caused by electric shock).
	The triangular warning symbol indicates important notes in this user manual which must be observed.
	This symbol indicates special tips and notes on the operation of the device.

Lists

<ol style="list-style-type: none"> 1. ... 2. ... 	Lists with a set order, given either in the text or warning notice
<ul style="list-style-type: none"> • ... • ... 	Lists without a set order, given either in the text or warning notice

Intended use

Only use the device for the purpose for which it was built and designed. Any other use is considered unintended!



This device may only be used for the following purpose(s):

- The Smartvest wireless alarm system enables easy access to modern homes with its combination of reliable all-round security and attractive home-automation functions. Up to 32 wireless components and four IP cameras can be connected to the Smartvest alarm panel via the free app, enabling you to access the alarm panel from anywhere in the world. If an alarm is triggered, the alarm panel activates its built-in, high-volume 90 dB siren; it can also raise the alarm simultaneously via push notifications in the app and email.

Important safety information

General

Before using this device for the first time, please read the following instructions carefully and observe all warning information, even if you are familiar with the use of electronic devices.

	All guarantee claims are invalid in the event of damage caused by non-compliance with this user manual. We cannot be held liable for resulting damage.
	We cannot be held liable for material or personal damage caused by improper operation or non-compliance with the safety information. All guarantee claims are void in such cases.

Retain this handbook for future reference.

If you sell or pass on the device to third parties, you must include these instructions with the device.

The following safety information and hazard notes are not only intended to protect your health, but also to protect the device from damage. Please read the following points carefully:

Power supply

- Only operate this device using a power source which supplies the grid voltage specified on the type plate. If you are unsure which power supply is available, contact your utility company.
- Disconnect the device from the power supply before carrying out maintenance or installation work.
- To fully disconnect the device completely from the mains, the mains plug must be withdrawn from the mains socket.
- In order to eliminate the risk of fire, the device's mains plug should always be disconnected from the mains socket, if the device is not being used for an extended period of time.

Overload/overvoltage

- Prior to unstable weather and/or when there is a risk of lightning strike, disconnect the device from the mains network or connect the device to a UPS.
- Avoid overloading electrical sockets, extension cables and adapters, as this can result in fire or electric shock.

Cable

- Always grasp all cables by the plug connector and do not pull the cable itself.
- Never grasp the power cable with wet hands, as this can cause a short circuit or electric shock.
- Do not place the device itself, items of furniture or other heavy objects on the cable and ensure that it does not become kinked, especially at the connector plug and at the connection sockets.
- Never tie a knot in the cable and do not bundle it together with other cables.
- All cables should be laid so that they cannot be trodden on, or cause a hazard.
- Damaged power cables can cause fire or electric shock. Check the power cable from time to time.
- Do not modify or manipulate the power cable or plug.
- Only use adapter plugs or extension cables that conform to applicable safety standards, and do not interfere with the mains or power cables.

Children

- Do not allow electrical devices to be handled by children. Do not allow children to use electrical devices unsupervised. Children may not properly identify possible hazards. Small parts may be fatal if swallowed.
- Keep packaging film away from children. Risk of suffocation.
- This device is not intended for children. If used incorrectly, parts under spring tension may fly out and cause injury to children (e.g to eyes).

Installation location/operating environment

Place or mount the device on a steady, level surface and do not place any heavy objects on the device. Make sure that there is adequate ventilation (do not place the Smartvest on a shelf, thick carpet, bed or wherever the ventilation slits may be covered. Always leave a gap of at least 10 cm on all sides).

The Smartvest is not designed for operation in rooms prone to high temperatures or humidity (e.g. bathrooms) or excessive dust accumulation.

For all components only suitable for indoor use, please ensure that

- no direct heat sources (e.g. radiators) have an effect on the components
- the components are not exposed to direct sunlight or strong artificial light
- no naked flames (e.g. lit candles) are placed on or next to the components
- contact with sprayed or dripping water is avoided
- the components are not operated in the vicinity of water and, in particular, never submerged (do not place objects containing fluids, e.g. vases or drinks on or near the device)
- the components are not exposed to large temperature fluctuations, as otherwise there may be condensation from humidity which may lead to electrical short circuits

For all components that are suitable for indoor and outdoor use, please ensure that

- the components are not exposed to excessive shock or vibration
- the components are not placed in the immediate vicinity of magnetic fields (e.g. loudspeakers)
- contact with aggressive liquids is avoided
- no foreign objects are able to penetrate the components
- the operating temperature and operating humidity of the components are observed.

Please refer to the relevant quick guide, technical information and installation instructions in chapter 3 for information on proper installation and compliance with the operating environment for components.

Battery

All Smartvest components, with the exception of power switches, are or can be supplied with a battery. In order to guarantee a long lifespan and avoid fire and injury, please follow the instructions below:

- Do not dispose of the battery with household waste.
- The battery must not be directly exposed to heat or sunlight, and must not be stored in hot places.
- The battery must not be burned.
- The battery must not come into contact with water.
- The battery must not be dismantled, pierced or otherwise damaged.
- The battery contacts must not be short-circuited.
- The battery must be kept away from small children.
- The battery cannot be recharged.

Unpacking the device

Handle the device with extreme care when unpacking it.

Packaging and packaging aids can be reused and, as far as possible, should be sent for recycling.

We recommend the following:

Paper, cardboard and corrugated cardboard as well as plastic packaging items should be placed in the appropriate containers provided.

If no such facility exists in the area, these materials should be put into the general household waste.



Warning

If the original packaging has been damaged, start by inspecting the device. If the device shows signs of damage, return it in the original packaging and inform the delivery service.

Start-up

Observe all safety and operating instructions before operating the device for the first time.



Warning

Improper or unprofessional work on the power supply system or domestic installations puts both you and others at risk.

Connect the installations so that the mains power circuit and low-voltage circuit always run separately from each other. They should not be connected at any point or become connected as a result of a malfunction.

Care and maintenance

Maintenance is necessary if the device has been damaged (e.g. damage to the power cable and plug, or the housing), or if liquids or foreign bodies have got into the interior of the device, or if it has been exposed to rain or damp, or if it does not work properly or has been dropped.

Maintenance

- If smoke, unusual noises or smells develop, switch the device off immediately and unplug from the socket. In such cases, the device should not be used until it has been inspected by a qualified technician.
- Have all maintenance tasks carried out by qualified technicians only.
- Never open the housing on the device or accessories. If the housing is open, there is the risk of fatal electric shock.

Cleaning

- Only clean the device housing with a damp cloth.
- Do not use solvents, white spirit, thinners etc. or any of the following substances:
Brine, insect spray, solvents containing chlorine or acids (ammonium chloride), or scouring powder.
- Rub the surface gently with the cotton cloth until it is completely dry.



The device operates with a dangerous voltage level. When conducting maintenance work (e.g. cleaning), disconnect the device from the mains.

Contents

1.	Device description	8
1.1.	FUAA35000 Smartvest	8
1.2.	FUHA35000 power switch	11

1.3.	FUMK35000 magnetic contact	12
1.4.	FUBW35000 PIR Motion Detector.....	13
1.5.	FURM35000 smoke alarm/heat detector	13
1.6.	FUSG35000 siren	14
1.7.	FUBE35000 Remote Key	15
2.	Start-up	16
2.1.	Installing the Smartvest App.....	16
2.2.	Setting up the Smartvest	16
2.3.	Pairing components	19
2.4.	General settings.....	21
3.	Installation.....	23
3.1.	FUAA35000 Smartvest.....	23
3.2.	FUHA35000 power switch	24
3.3.	FUMK35000 magnetic contact	24
3.4.	FUBW35000 PIR Motion Detector.....	26
3.5.	FURM35000 smoke alarm/heat detector	27
3.6.	FUSG35000 siren	28
3.7.	FUBE35000 Remote Key	29
4.	Operation	30
4.1.	Navigation bar and footer	31
4.2.	Overview	32
4.3.	Hotkeys	34
4.4.	Rooms	35
4.5.	Cameras	37
4.6.	Contacts.....	39
4.7.	Basic event	40
4.8.	Alarm view	41
5.	Configuration	42
5.1.	Configuration overview	43
5.2.	Components	44
5.3.	Hotkeys.....	52
5.4.	Scenarios.....	53
5.5.	Schedules	54
5.6.	Advanced settings	55
6.	Technical data	60

1. Device description

This chapter contains descriptions of the Smartvest and all associated components.

1.1. FUAA35000 Smartvest

Front

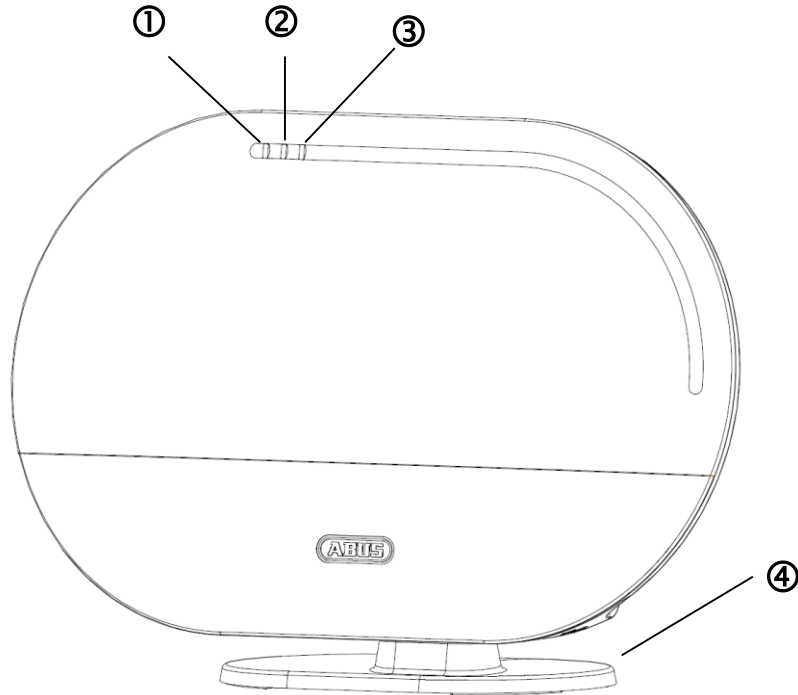

①	Power LED	Green	On	System is supplied with power	
			Off	No power supply	
②	Status LED		Off	System is "disarmed"	
			Yellow	On	The system is "disarmed" and there is a fault (e.g. battery dead or magnetic contact is "open")
			Blue	On	System is "armed"
			Red	On	System is "armed" and in the alarm state (normal alarm, tamper alarm or panic alarm)
③	Network LED		Green	On	Connection to network and internet
				Off	Connection to network without internet
			Red	Flashing	No network connection
④	Optional stand. Removable for wall installation.				

Under side

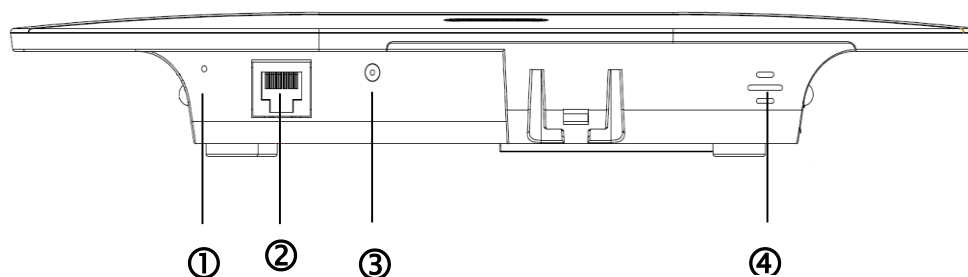

①	Reset button	<p>To reset passwords to the default settings (123456) and network settings to DHCP:</p> <ul style="list-style-type: none"> While the system is in operation, press and hold the reset button for >10 seconds using a paper clip. The power LED will go out and a continuous tone will sound. The system then restarts. <p>Resetting the system to the default settings means that all settings are reset and component pairings are deleted.</p> <ul style="list-style-type: none"> Press the reset button with the alarm control panel turned off, and hold it for >10 seconds while turning on the alarm control panel. The power LED will go out and a continuous tone will sound. The system then restarts.
②	RJ45 connector	Integrated network access 10/100 Mbit
③	Voltage supply	5 V DC/1.5 A. Device starts automatically when powered by line voltage.
④	Hygrometer	Integrated hygrometer for measuring temperature and humidity

Rear

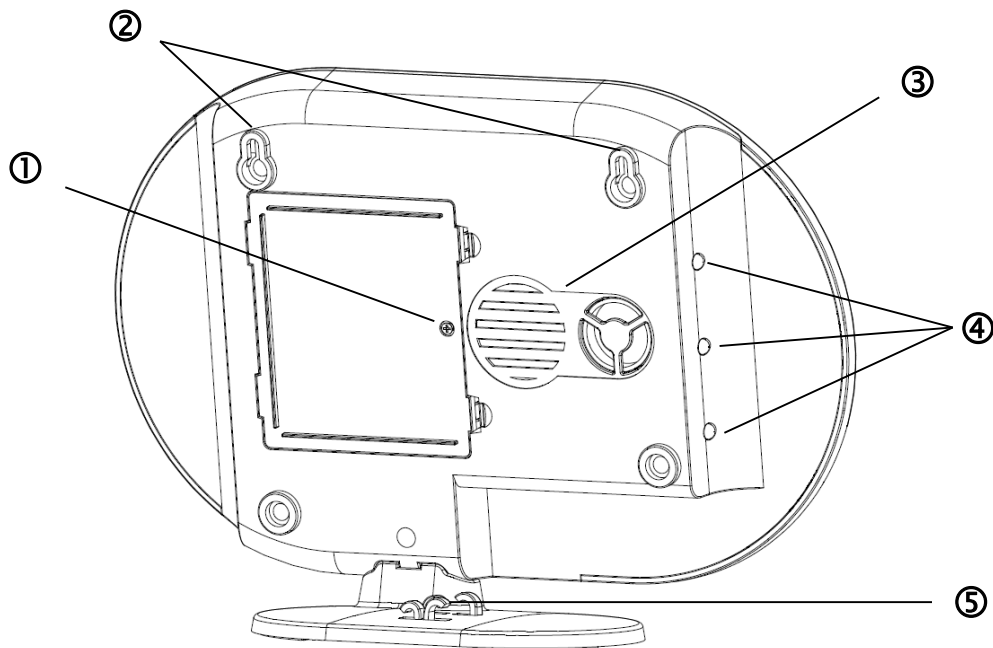

①	Battery operation	<p>6 x AA (1.5 V) batteries for backup power supply (approx. 5h battery life)</p> <p>Changing the battery Push the clips to open the battery compartment cover. Remove the dead 6 AA (1.5 V) batteries from the compartment and replace with the new 6 AA (1.5 V) batteries. Make sure they are facing in the direction shown on the compartment floor, then close the battery compartment by replacing the cover.</p>		
②	Mounting bracket	<p>Mounting bracket for wall installation Drill hole spacing: 10 cm (drilling template provided)</p>		
③	Loudspeaker	<p>Smartvest loudspeaker with a maximum volume of 90db.</p>		
④	Background LEDs	Off	Off	System is "disarmed"
		Yellow	On	The system is "disarmed" and there is a fault (e.g. battery dead or magnetic contact is "open")
		Blue	On	System is "armed"
		Red	On	System is "armed" and in the alarm state (e.g. magnetic contact open).
⑤	Cabling	<p>Cabling for power supply and network cable.</p>		

1.2. FUHA35000 power switch

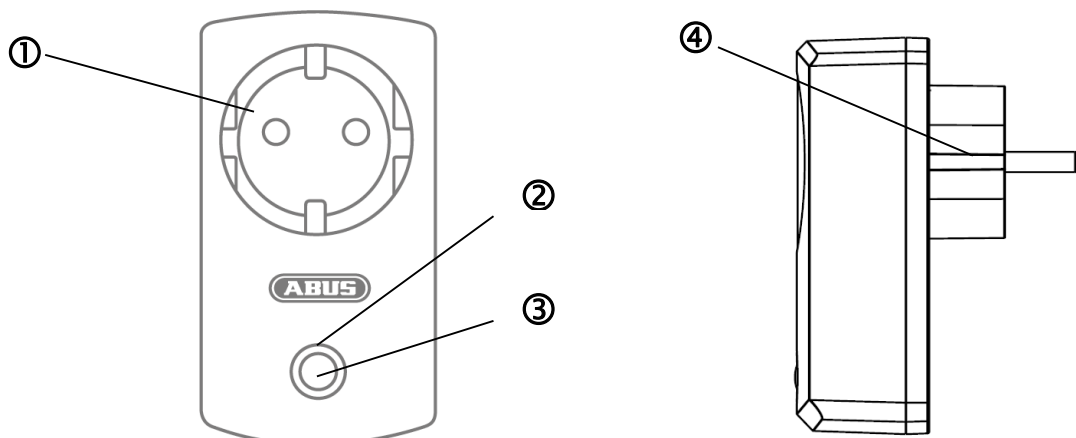

①	Schuko socket	Schuko socket type F (CEE 7/4). Can be used in the following countries: Germany, Austria, Sweden, Netherlands		
②	Status LED		Off	Power switch is activated; power is being transmitted.
		Blue	On	Power switch is ready and activated; power is not being transmitted to the consumer.
			Flashing	Power switch is starting up
		Orange	Flashing	Repeater mode started
On	Power switch is ready and activated; power is not being transmitted to the consumer. Repeater mode on and connected with a component.			
③	Button	Press this button once to activate or deactivate the power switch.		
		To do so, press and hold the button for five seconds, to activate repeater mode.		
④	Schuko socket	Schuko socket type F (CEE 7/4). Can be used in the following countries: Germany, Austria, Sweden, Netherlands		

Repeater mode

As well as switching consumers, the power switch can also be used as a wireless repeater for another component. To do this, take the following steps:

1. Press and hold the button for five seconds to activate repeater mode. The status LED starts to flash orange.
2. For any components that you want to connect to the power switch, carry out the manual process for pairing components (see chapter 5, Configuration).
3. The status LED lights up orange when the connection is successful
4. To deactivate repeater mode again, first disconnect the switch. Press and hold the button. Reconnect the switch. Wait until the LED flashes blue and only then release the button. If deactivation was successful, the LED will now light up blue.



Note

It is only ever possible to connect one component to a power switch.

1.3. FUMK35000 magnetic contact

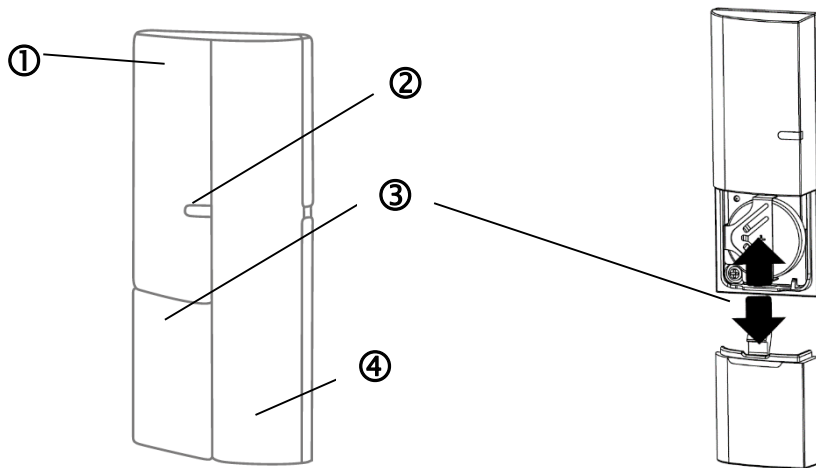

①	Transmitter component	Contains a wireless component Mounted on window frame		
②	Signal LED	Blue	Flashing	Magnetic contact is closed Magnetic contact is opened
③	Battery operation	<p>1x 3V button battery (CR2032) for power supply (up to one year battery life).</p> <p>The Smartvest App warns you when the battery is low. Follow the instructions in the app.</p> <p>Changing the battery</p> <p>Slide the battery compartment cover out in a downwards direction.</p> <p>Remove the dead 3V button batteries from the holder provided and replace with a new 3V battery, then close the battery compartment by replacing the cover.</p>		
④	Magnet component	Contains a magnet component Mounted on window		

1.4. FUBW35000 PIR Motion Detector

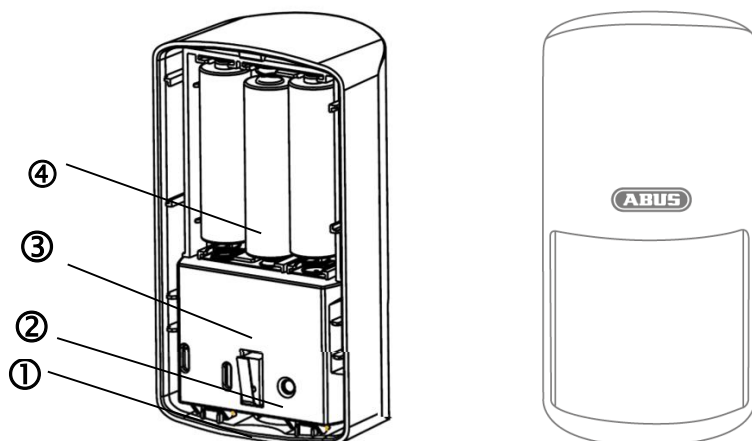

①	Catch	Catch for removing the rear panel
②	Pair button	Button for manual pairing with the Smartvest Activate test mode: press for 5 s Deactivate test mode: press for 5 s
③	Tampering contact	Tampering contact for alarming in the event of unwanted removal
④	Battery operation	3 x AA (1.5 V) batteries for power supply (up to two years battery life) The Smartvest App warns you when the battery is low. Follow the instructions in the app. Changing the battery Press the catch on the underside of the PIR Motion Detector and remove the rear panel. Remove the dead 3 AA (1.5 V) batteries from the compartment and replace with the new 3 AA (1.5 V) batteries. Make sure they are facing in the direction shown on the compartment floor, Reattach the PIR Motion Detector to the mounted rear panel.



Note

In test mode, the PIR Motion Detector's energy-saving mode is deactivated so it triggers each time motion is detected. Use this to check whether the detector fully covers the monitored space. Deactivate test mode after use, as otherwise this will severely affect the battery life.

1.5. FURM35000 smoke alarm/heat detector

Refer to the instructions for the smoke alarm/heat detector.

1.6. FUSG35000 siren

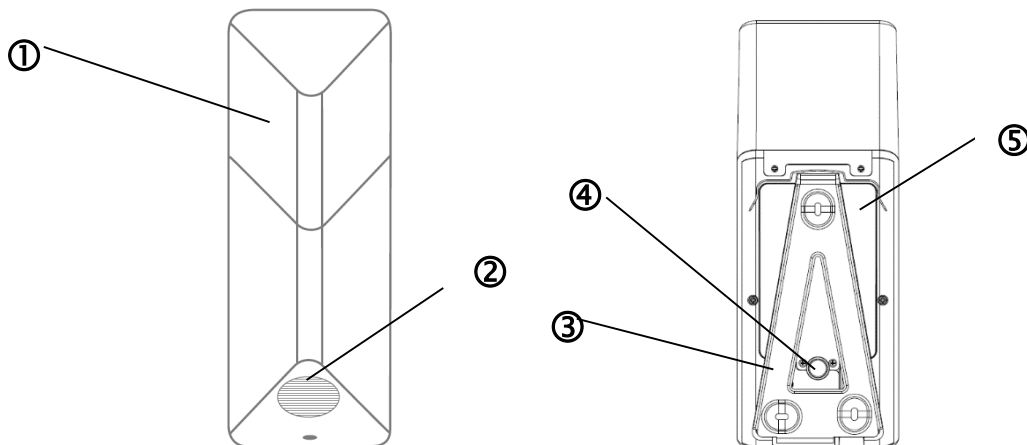

①	LED chamber	LED flashes (according to setting) in the event of an alarm and to acknowledge changes to the siren settings.
②	Loudspeaker	Siren loudspeaker with a maximum volume of 80 db or 100 db.
③	Pair button	Button for manual pairing with the Smartvest
④	Tampering contact	Tampering contact for alarming in the event of unwanted removal
⑤	Battery operation	<p>4 x C (1.5 V) batteries for power supply (up to two years battery life)</p> <p>Changing the battery</p> <p>Loosen both screws on the cover. You do not need to completely remove the screws. Lift the cover upwards from the bottom and remove.</p> <p>In order to access the screws more easily when changing the batteries, you can temporarily remove the tampering contact's rubber cover.</p> <p>Remove the dead 4 C (1.5 V) batteries from the compartment and replace with the new 4 C (1.5 V) batteries. Make sure that the battery is always positioned with the negative end against the spring. Place the top end of the cover into the holes provided and attach the cover beneath using the two screws.</p>

1.7. FUBE35000 Remote Key

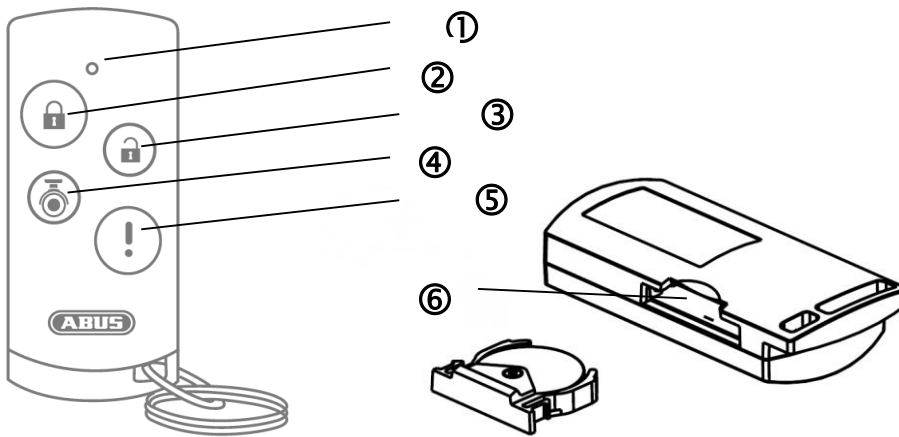

①	Signal LED	Blue	Flashing	Acknowledges when button is pressed
②	Arm button	Button for arming the Smartvest Press and hold for 5 seconds to switch internally armed		
③	Disarm button	Button for disarming the Smartvest		
④	Camera button	Button to start recording for connected cameras		
⑤	Panic button	Button for triggering the panic alarm (press for 3 seconds)		
⑥	Battery operation	<p>1x 3V button battery (CR2032) for power supply (up to two years battery life)</p> <p>The Smartvest App warns you when the battery is low. Follow the instructions in the app.</p> <p>Changing the battery</p> <p>Remove the battery compartment on the side of the Remote Key.</p> <p>Remove the dead 3V button batteries from the holder provided and replace with a new 3V battery, Push the battery compartment back into the Remote Key.</p>		







Note



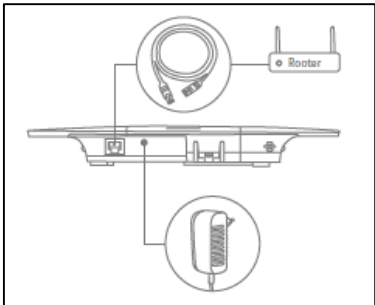

The exact reaction caused when a button is pressed depends on the app settings. Refer to Section 5.6, Advanced settings for the arm and disarm buttons, and Section 5.3, Hotkeys for the camera button and panic button.

2. Start-up

Before installing your Smartvest and detector, follow the steps below to start up your Smartvest and pair components with the Smartvest.

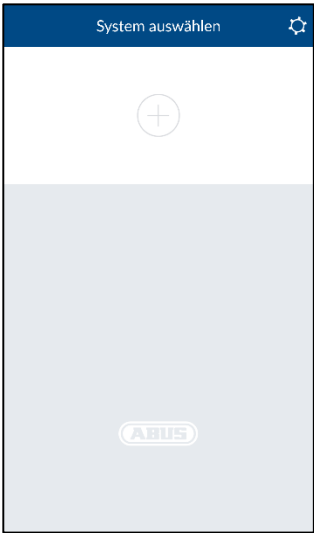
2.1. Installing the Smartvest App					
	<p>For the Smartvest, there is an app called "Smartvest" available for download from the Google Play Store and the iOS App Store. This app can be used on smartphones and tablets, referred to as "end devices" from this point on.</p> <p>For installation, go to the Google Play Store or the iOS App Store and search for "Smartvest".</p> <p>Install the Smartvest App.</p> <p> Note Please note that the following operating systems are a minimum requirement for running the Smartvest App:</p> <table style="margin-left: 40px;"> <tr> <td>Apple</td> <td>iOS 7</td> </tr> <tr> <td>Android</td> <td>4.0</td> </tr> </table>	Apple	iOS 7	Android	4.0
Apple	iOS 7				
Android	4.0				

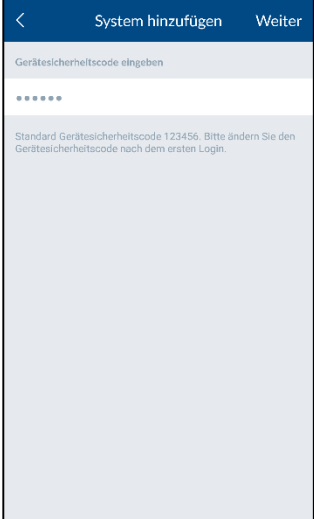
2.2. Setting up the Smartvest	
	<p>First connect the LAN cable provided on the underside of the Smartvest and connect this to your router, then connect the power supply unit provided.</p> <p> Note Ensure that the DHCP function is activated on your router as otherwise it will not be possible to connect to the Smartvest.</p> <p>Only start setting up the Smartvest via the app when the green power LED lights up continuously and the alarm panel beeps twice.</p> <p>There is no double beep sound if integrated into a local network without Internet access.</p>

	<p>Open the Smartvest App and carry out the following steps:</p> <p>Start setup</p> <p>Tap the plus sign  to add a Smartvest. The app then automatically searches for devices on your network.</p>
	<p>Select</p> <p>Select your Smartvest from the list. If you want to link the Smartvest from another network or the Smartvest is not found, enter the DID manually. All further entries must then also be made manually.</p>
	<p>Device security code</p> <p>The standard security code "123456" is already stored. When setting it up for the first time, press "Next". If the device security code has already been changed, enter the correct code here.</p> <p> Standard security code: "123456" When logging in for the first time, you will asked to change the device security code.</p> <p> Note You can change the security code in the settings. If you have already changed the security code, you can enter this here manually before tapping "Next".</p>

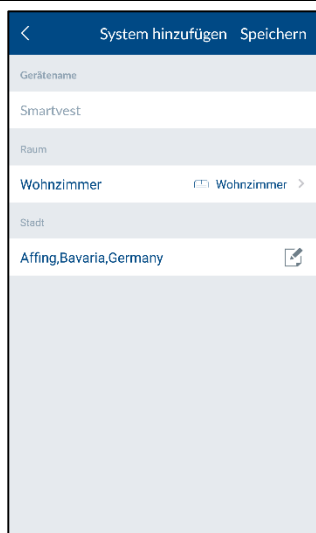

Name assignment, room and location information

Assign a name to the Smartvest. The name "Smartvest" will be stored initially.

Open the room list and select a room where the Smartvest is mounted. Tap the arrow  to return to the previous window.

To display weather information, tap the town row and search for your location using the place name or postcode and select your location from the results returned.



Note

The location data is used solely to ascertain weather information.

End setup

Tap "Save" to finalise the entries.

You have now linked your Smartvest to the app.

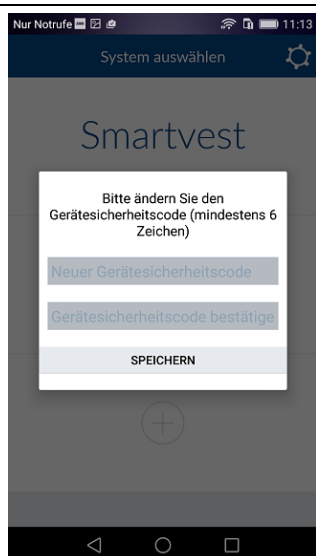

Changing the device security code during initial commissioning

When completing the initial commissioning (or after resetting the alarm control panel to the default settings), you will be asked to change the device security code. It must contain a minimum of 6 characters and a maximum of 16 characters. The following characters are permitted:

- Letters (a–z / A–Z)
- Digits (0–9)
- Special characters: + - * / % = _ ! ? @ # \$ & () , . ; :



Note

The security code must not be changed to "123456". You can change the device security code at any time in the settings (Advanced settings/security settings).

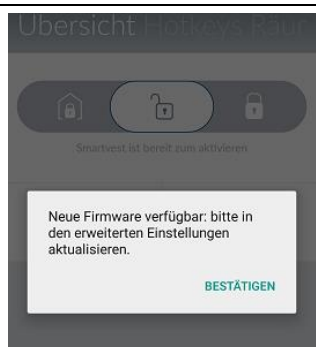

New firmware available

Run a firmware update for the Smartvest alarm control panel to be able to use all new functions within the Smartvest app.

You can start the update in the advanced settings (chapter 5.6).

2.3. Pairing components

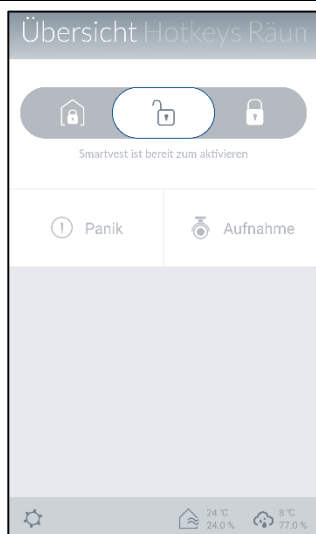

Open the Smartvest App and connect to the Smartvest.



Note

The settings for your components can be found in chapter 5.1, Components.

Carry out the following steps:

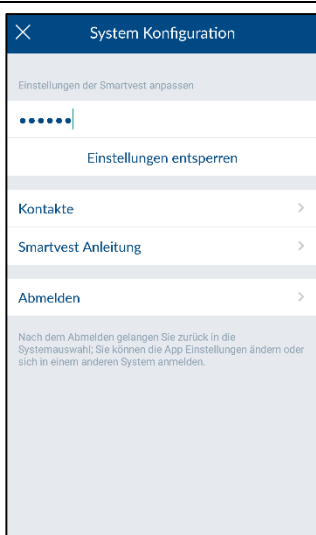

Open Smartvest settings

To access the Smartvest settings, tap the settings symbol  in the bottom left-hand corner of the operation view. Enter the settings password (standard: "123456") to access all settings options.



Standard settings password: "123456" You can adjust this in the "Advanced settings/security settings".

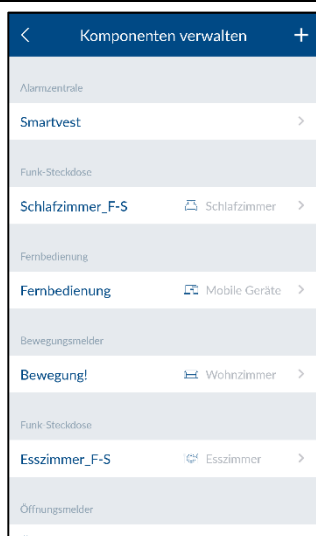

Select components

Select "Components" from the top of the list.

Tap the plus sign  in the top right-hand corner to add a component.

Select the desired components from the list.

In order to abort the pairing for a component, tap "Cancel" in the individual window.

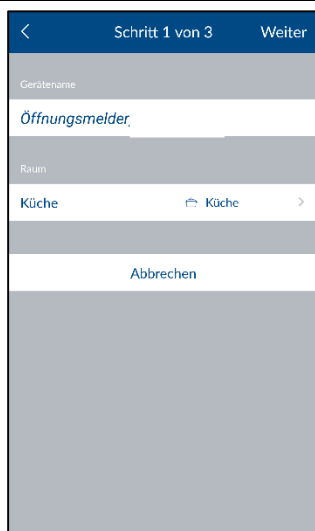

Pair components

Enter a name for the component.



Note

The name must have a maximum of 15 characters. Additional characters will be automatically deleted after saving.

Open the room list and select the room where the component is installed. Tap the arrow  to return to the settings.

Now tap "Next".

Follow the instructions in the app.

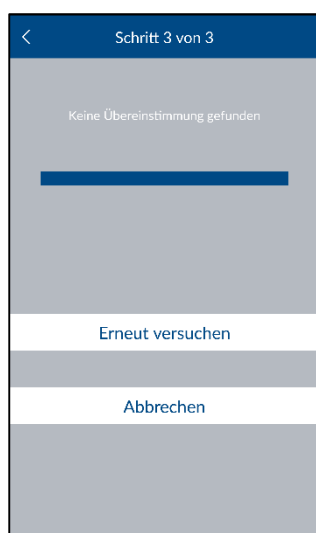

Attention

If automatic pairing has not worked as per the instructions provided, there is a procedure for manually pairing each component. This can be found under chapter 5.1., Components.

The settings for your components can also be found in chapter 5.1., Components.

Repeat these steps for all of your components.



Note

In principle, all components send the read-in signal as soon as they are connected to the power supply.



Note

In order to link compatible cameras to the Smartvest, please follow the relevant instructions for setting up the camera on your network first. If you have connected the camera to the same network as the Smartvest alarm control panel using a LAN cable, you can also adjust the settings using the Smartvest app. Chapter 5 (Configuration) describes how to pair the camera.

Now install the components and the Smartvest as described in the following chapter ("Installation").

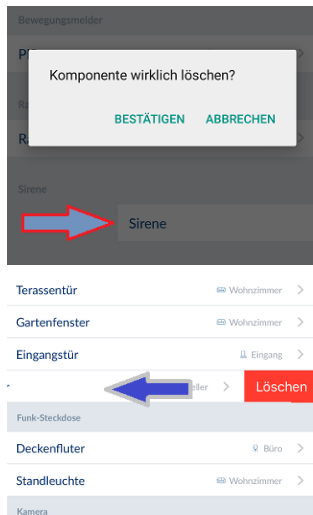

Removing components

Open the component list and...

For Android:

... slide the components to the right-hand edge of the screen and confirm removal

For iOS:

... slide the components to the left-hand edge of the screen and press "Delete"

2.4. General settings

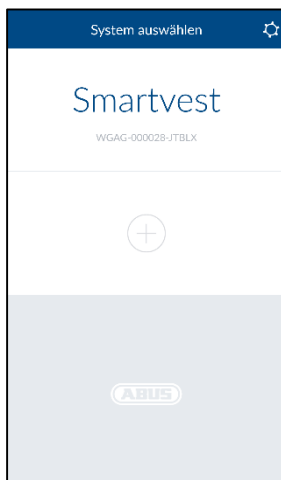

Open the Smartvest App and tap the settings symbol  in the top right-hand corner to access the general settings.

Available systems

Add a new Smartvest to the app or select your Smartvest to access the Smartvest's general settings.

Smartvest details

If the security code has been changed or entered incorrectly, you can adjust this here for the Smartvest connection.



Note

Chapter 5 (Configuration) describes how to change the security code.

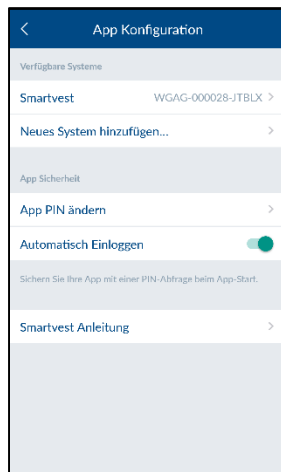

Enable "Automatic log in" to skip manual connection to the Smartvest. The next time you start the app, you will be taken directly to the Smartvest overview.

Tap "Remove system from App" to delete the Smartvest.

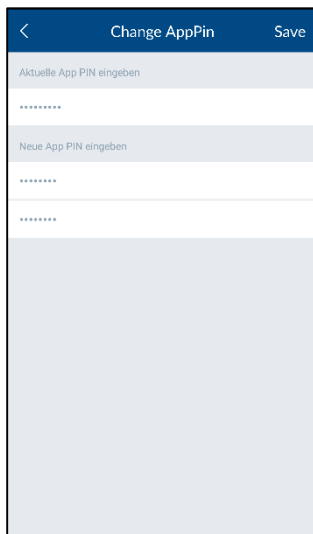

App security

Tap "Change app PIN" to enter your own app PIN. During the initial setup, the standard app PIN "123456" is stored.



Attention

If the app PIN is enabled, you will be asked to enter this each time you start the app on your end device. If you have forgotten your app PIN, you must delete the app and reinstall it.



Standard app PIN: "123456"

Disable "Automatic log in" for the app PIN to ensure the app PIN is requested each time the app is started. Use this to prevent anyone else using the end device from accessing the app.

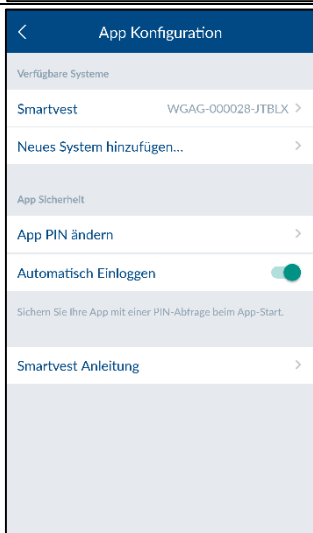

Manual

Here you can access the Smartvest manual from your smartphone.

3. Installation

This chapter describes how to install the Smartvest and the associated components.

Please refer to chapters 4 and 5 when operating and adjusting the settings for the Smartvest via the Smartvest App.



Warning

When using adhesive pads, ensure that the surface below is clean, abrasion-resistant and dry.

On account of their properties, wallpaper and polystyrene or surfaces coated with silicone or Teflon are not suitable for the installation of the smoke alarm device.

3.1. FUA35000 Smartvest

The Smartvest is only suitable for indoor use. For further information, please refer to the safety instructions relating to installation location and operating environment.

General installation instructions

Ensure that your Smartvest has a backup power supply before installation.

1. To do this, open the battery compartment cover by pressing both clips.
2. Remove the plastic strip.
3. Replace the cover.

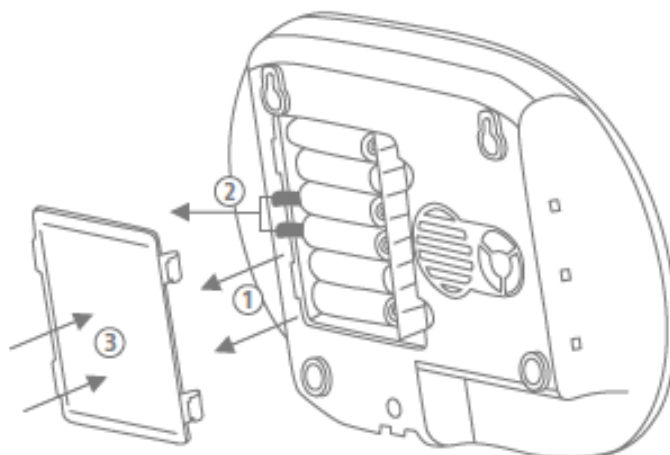

Free-standing installation

Press the Smartvest onto the base and place the Smartvest in the desired location. The cables can be clipped onto the base to ensure they are neatly laid.

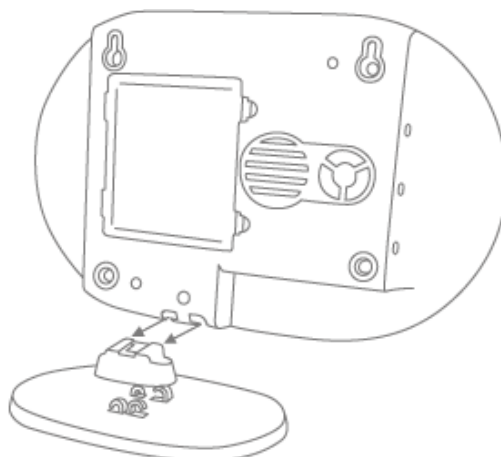

Wall installation

Stick the Smartvest drilling template to the desired installation location. Use a spirit level to ensure the drilling template is straight. Drill holes in the specified positions and insert the screw anchors provided. Screw the screws provided into the screw anchors so that the heads protrude by around 6 mm, then mount the Smartvest.

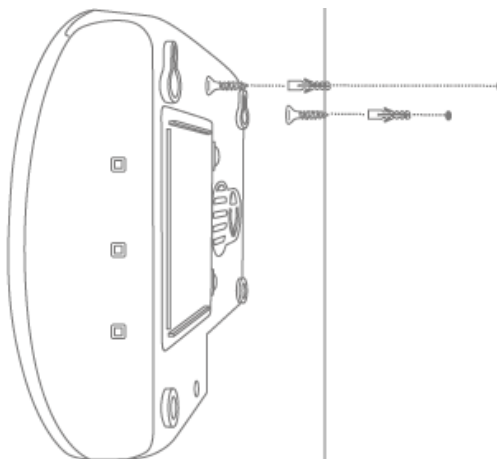

3.2. FUHA35000 power switch

The power switch is only suitable for indoor use. For further information, please refer to the safety instructions relating to installation location and operating environment.

Power switches must never be connected in series.

Installation

Plug the power switch into a socket and plug the desired consumer (e.g. a lamp) into the power switch.

3.3. FUMK35000 magnetic contact

The magnetic contact is only suitable for indoor use. For further information, please refer to the safety instructions relating to installation location and operating environment.

General installation instructions

- Always install the smaller magnet component on the window or door and the larger transmitter component on the window or door frame.
- Install the magnetic contact so that the two components are a maximum of 0.5 cm apart horizontally and 1.5 cm apart vertically.
- If in doubt, test whether the height difference on your window or door is too great by holding the two components next to each other in the desired position on the window or door and then moving the transmitter component to the window or door frame. If the blue signal LED lights up, the height difference is too great.
- To even out the height difference, use the washers provided, which need to be attached to the rear of the components. The screws provided are not compatible with washers. Either use your own screws for this or the adhesive pads provided (recommended).
- Always install the magnetic contact on the side of the window or door which is opened and not on the hinge side.
- You can either install the magnetic contact on the top or the side of the window. If you install the magnetic contact on the underside of the window, the magnetic contact may not trigger if the window is tilted (not recommended).

Installation with adhesive pads (recommended)

1. Stick both the small adhesive pads on to the magnetic contact's large transmitter components and the longer adhesive pad on to the smaller magnet component.
2. Stick the large transmitter component to the window frame in the desired position in relation to the window and stick the smaller magnet component to the window itself.

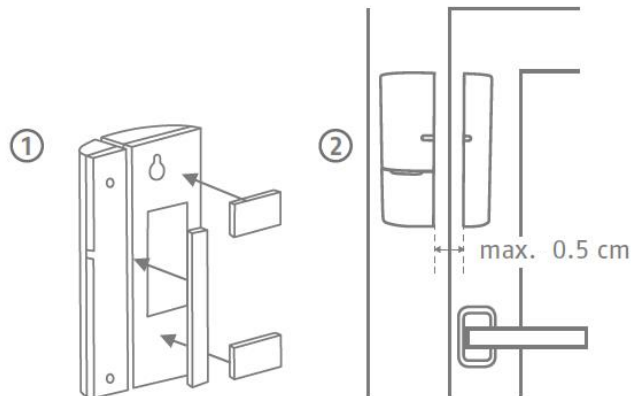

Installation with screws

1. Open the magnetic contact's smaller magnet component with a thin slotted screwdriver.
2. Remove the battery compartment cover from the magnetic contact's larger transmitter component.
3. Screw the smaller magnet component in the desired position on the window using two screws. You must first break through the intended holes using a screwdriver or drill.
4. Screw one screw into the window frame for the transmitter component's keyhole fitting.
5. Attach the transmitter component and fix to the window frame with the remaining screw.

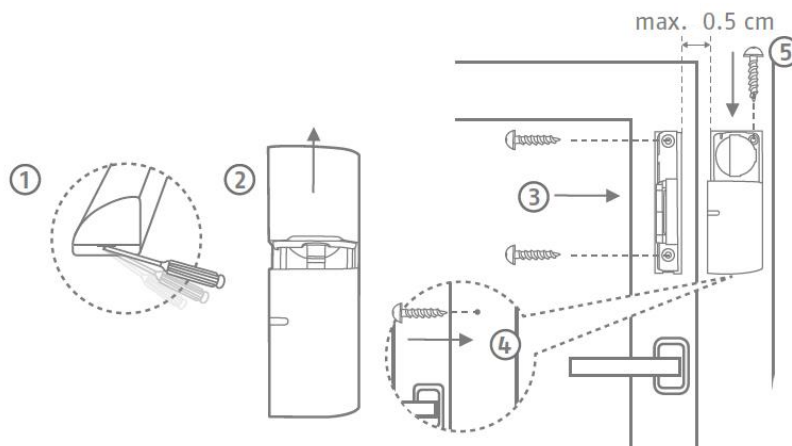

3.4. FUBW35000 PIR Motion Detector

The motion detector is only suitable for indoor use. For further information, please refer to the safety instructions relating to installation location and operating environment.

General installation instructions

- Install the motion detector 2–2.5 m above the ground for a range of 12 m.
- Install the detector either flush to the wall or in a corner (recommended).
- Do not install the motion detector opposite heat sources or windows, above a radiator, close to large metallic structures, close to power cables or gas lines, close to electronic or wireless equipment, or closer than 30 mm to the ceiling.
- The detector's detection range is directed downwards. For this reason, do not tilt the detector too sharply downwards, as otherwise the range will be restricted. A horizontal, upright position is recommended.

Adhesive installation

1. For wall installation, stick the adhesive pads provided on to the rear of the motion detector.
2. For corner installation, stick the adhesive pads on to the motion detector's chamfers (angled surfaces).
3. Install the motion detector in the desired installation location on a flat surface.

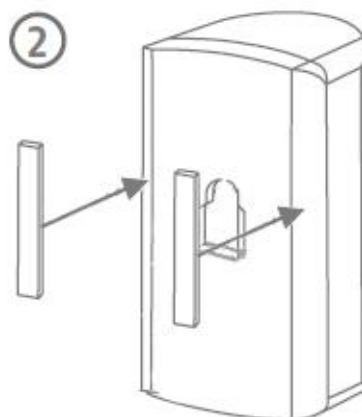
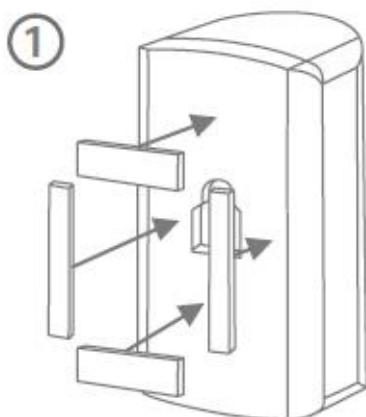

Drill installation using bracket

1. Press the bracket into the motion detector.
2. Hold the motion detector next to the desired installation location and adjust to the desired angle.
3. Fix the position by tightening the screw on the rear of the bracket.
4. Stick the motion detector's drilling template in the desired installation location. Use a spirit level to ensure the drilling template is straight. Drill holes in the specified positions and insert the screw anchors provided.

Remove the bracket and fix it in place using the screws provided. Finally, press the motion detector back on to the bracket.

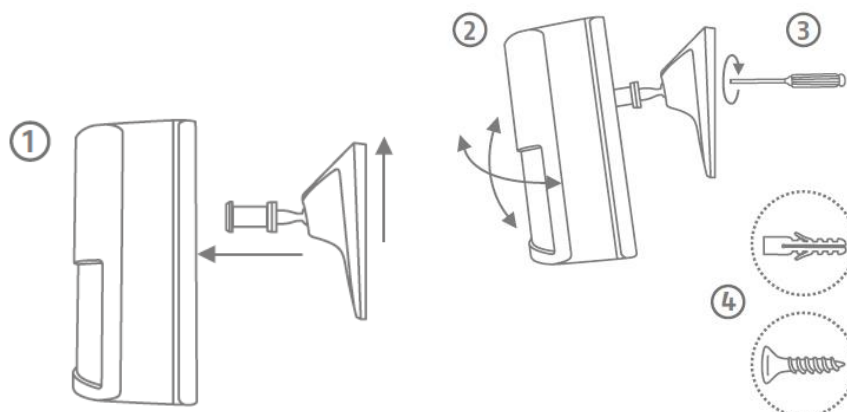
**Drill installation without bracket**

1. Press the catch on the underside of the motion detector and remove the motion detector's rear panel.
2. Use the holes provided on the inside of the rear panel as a drill template for wall or corner installation.
3. Drill the holes and insert the screw anchors provided. Next, screw the motion detector's rear panel into the wall or corner using the screws provided.
4. Press the motion detector back on the fitted base plate of the motion detector.

3.5. FURM35000 smoke alarm/heat detector

The smoke alarm/heat detector is only suitable for indoor use. For further information, please refer to the safety instructions relating to installation location and operating environment and to the instructions for the smoke alarm/heat detector.

Installation

Refer to the instructions for the smoke alarm/heat detector for installation.

3.6. FUSG35000 siren

The siren is suitable for indoor and outdoor use. For further information, please refer to the safety instructions relating to installation location and operating environment.

General installation instructions



Warning

The tamper contact may be triggered when installing the siren. In this event, the siren is set to **"LED"** by default. If you have already configured the siren as **"Siren"** or **"LED and siren"**, please reset this to **"LED"** before installation. Otherwise, if for instance the siren's alarm tone is suddenly triggered when carrying out an installation at a great height, this could lead to a serious accident and physical injury or damage.

Alternatively, you can activate maintenance mode in order to avoid false alarms. See chapter 5 ("Configuration").

When testing the siren's acoustic alarm tone, always maintain a minimum distance of 3 m in order to avoid physical damage (e.g. to hearing).

- The siren is only suitable for use in protected outdoor areas (IP44).
- Ensure that the siren is installed within hand's reach (minimum 3 m installation height).
- When choosing the installation location, ensure that the siren can be seen and heard from a long distance.
- Pressing the tamper contact for the first time activates the tamper contact. After this, if the tamper contact is triggered, the tamper alarm is triggered.

Drill installation

1. Stick the motion detector's drilling template in the desired installation location. Use a spirit level to ensure the drilling template is straight. Drill holes in the specified positions and insert the screw anchors provided. Remove the drilling template.

Attach the A-shaped bracket to the wall using the screws.

2. Connect the power supply unit provided to the siren and hook the sirens into the bracket from above (click 1), then press it against the wall (click 2).
3. Now tighten the small screw on the underside of the bracket.

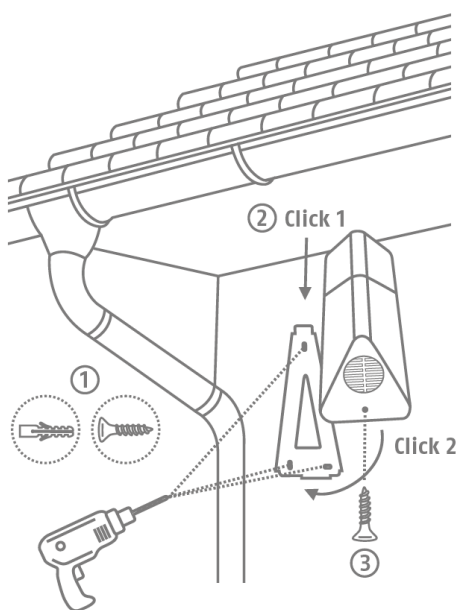

3.7. FUBE35000 Remote Key

The Remote Key is only suitable for indoor use. Note the information provided in the safety instructions relating to the operating environment.

Installation

Use the keyring to attach the Remote Key to your bunch of keys or similar.

4. Operation

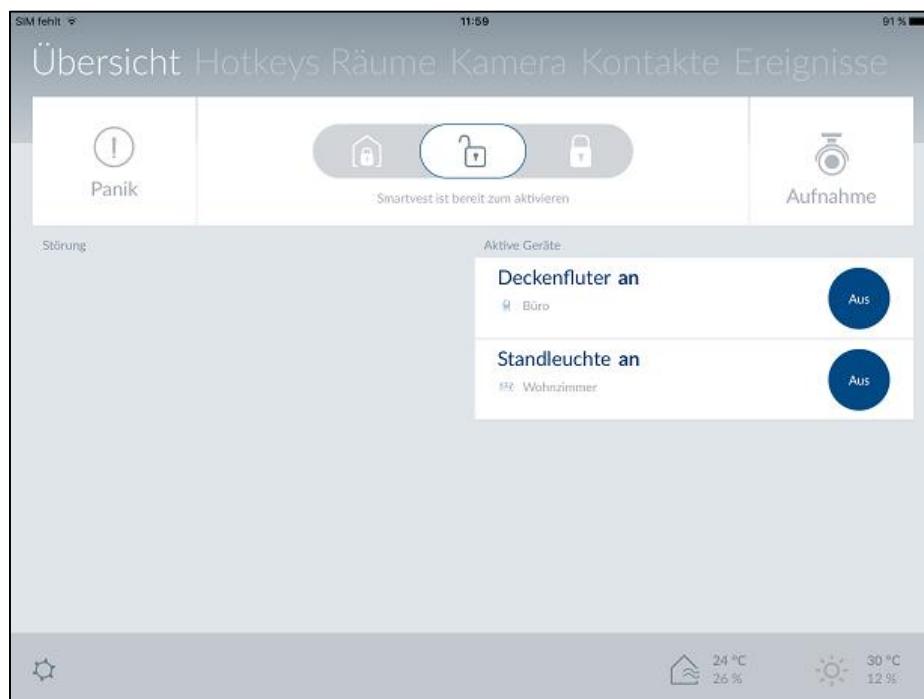

The Smartvest App is divided into two basic menus, operation and configuration.

This chapter will show you how to operate the Smartvest via the Smartvest App.

Please refer to chapter 5 to find out how to configure the Smartvest.

The following functions are available in the operation menu:

- overview of the most important information and functions
 - switching the Smartvest to armed/part set/disarmed
 - Active devices
 - faults
- overview and activation of your hotkeys
- overview of your rooms and the status of the room detectors
- overview and live view of your cameras
- overview and call contacts
- overview of events



Note

Depending on the operating system and end device used, the actual display may differ slightly from the screenshots included in this manual. In this manual, the menu overviews are illustrated using tablet screenshots, while the descriptions of the individual menu items are illustrated using smartphone screenshots. The descriptions of the menu items and navigation are however identical on each device.

4.1. Navigation bar and footer

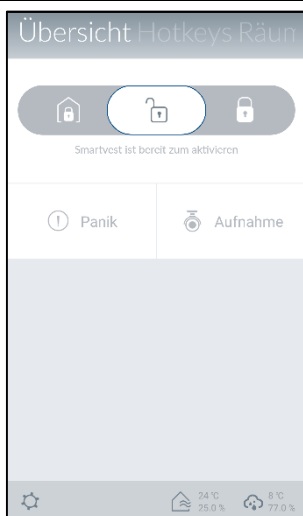

Open the Smartvest App and connect to the Smartvest.

Navigation bar

View

The individual menu items are shown in the navigation bar at the top. The menu you are currently viewing is highlighted in colour.

Switching menu

You can switch between the individual menus by "swiping" your finger across the screen from left to right or vice versa. Alternatively, you can switch between the individual menus by tapping on the desired menu in the menu bar.

Colour code

The Smartvest's current status is indicated in the navigation bar using a colour code.

Grey	System is "disarmed"
Yellow	The system is "disarmed" and there is a fault (e.g. battery dead)
Blue	System is "armed"
Red	System is "armed" and in the alarm state (e.g. magnetic contact open, panic or tampering).

Footer

Settings

The settings symbol  is located in the bottom left-hand corner of the footer. Tap this symbol to access the Smartvest settings.

Temperature, humidity and weather display

Temperature, humidity and weather information are displayed in the bottom right-hand corner.

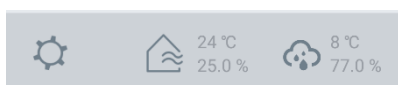

Indoor temperature and humidity display, as measured by the Smartvest's hygrometer



Weather display for the location set in the Smartvest settings



Note

The hygrometer values for indoor areas need around 30 minutes after start-up to level off.

4.2. Overview

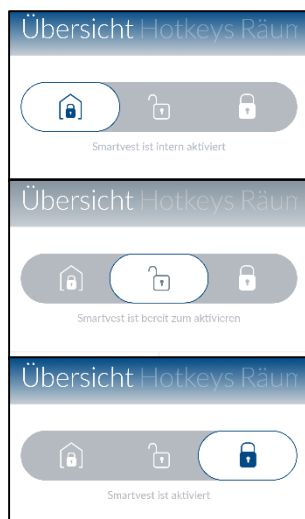

Status display

Three different symbols are used to represent the different Smartvest statuses in the status display. The current status is marked in colour, with the relevant text shown below. You can change the status by dragging to the left or right or, alternatively, by tapping the desired status.



Smartvest is internally armed

The internal arming is pre-programmed as perimeter protection ex-works. This means that opening detectors do trigger an alarm whereas motion detectors do not. This means you can move around freely inside the house (internally) without triggering an alarm. However, the opening detector triggers an alarm if anyone enters the premises from the outside. Recommended application: Set the Smartvest to internally armed before you go to bed.



Smartvest is unarmed (ready to arm)

In this status, the system is not live. Notifications from most sensors do not trigger an alarm. The only exception is the smoke alarm device which, for your own safety, always triggers an alarm irrespective of the system status. In addition, an alarm is triggered if any of the components sends a sabotage message. Recommended application: Set the Smartvest to disarmed when you come home.



Smartvest is armed

The arming is pre-programmed as full protection ex-works. This means that all sensors trigger an alarm. Recommended application: Set the Smartvest to armed when you leave the house and there is no-one else at home.



Note

When pairing components, standard values are automatically set for the active status. Should you wish to alter the settings for the status in question, you can find the settings under point 5.5 – Advanced settings/Status configuration.

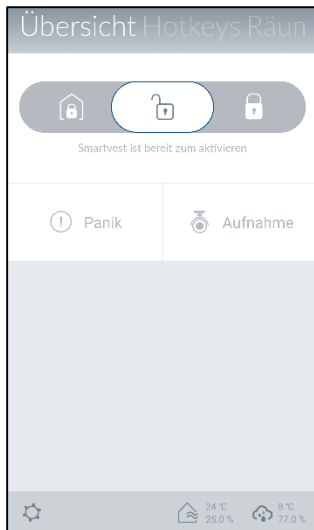

Hotkeys

There are two pre-configured hotkeys – panic and camera – below the status display, which you can tap and enable in the overview. These two hotkeys are also found on the FUBE35000 Remote Key and can be operated from there.



Standard:

All actuators are triggered (e.g. sirens) and all cameras are recording



Standard:

All cameras are recording



Note

When pairing components, standard values are automatically set for the pre-configured hotkeys. Should you wish to alter the settings for the hotkey in question, you can find the settings under point 5.3, Hotkeys.

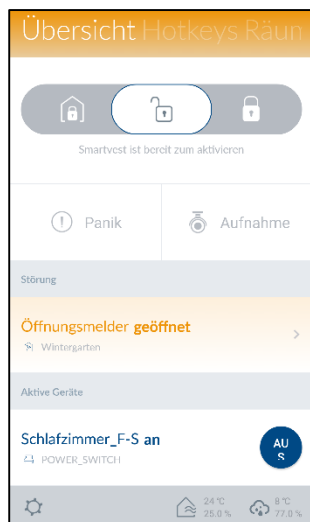

Fault

Should any faults occur (e.g. battery dead), these are shown below the hotkeys. Once the faults have been remedied, they are no longer shown in the overview.

You can also find the fault messages in the event overview (4.7).

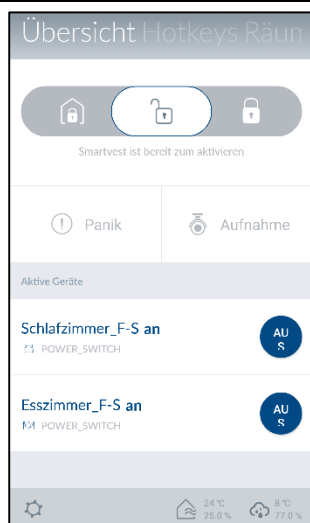

Active devices

Components with an active status (e.g. power switch "on") are displayed in a list. Once the components are deactivated, they are no longer shown in the overview.

This means you always have an overview of any devices consuming power.

4.3. Hotkeys

Application examples

Hotkeys enable straightforward activation of various components with just a tap.

Should you become aware of any potential intruders outside your house before they have attempted to break in, you could, for example, configure a hotkey (panic) to activate the siren, which you could then tap to scare off the intruder before they break in.

Alternatively, you could create a user-defined hotkey to activate one or several power switches and switch your home lighting on and off by tapping the hotkey.



Hotkey overview

Up to 11 hotkeys can be displayed in the hotkey overview. Two pre-configured hotkeys – panic and camera – are already stored upon initial start-up. In the settings (see chapter 5.3, Hotkeys), you can add nine further hotkeys in the overview or edit the hotkeys already available.

To do this, simply tap the desired hotkey.

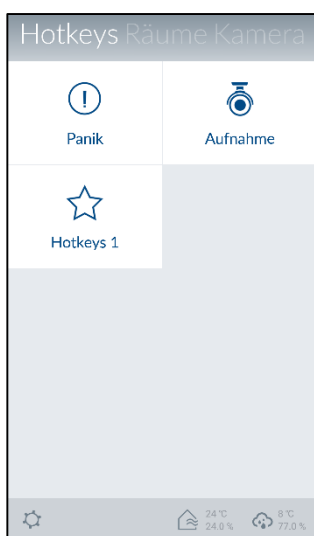

Pre-configured hotkeys

There are two pre-configured hotkeys – panic and camera – in the hotkey overview. These two hotkeys are also found on the FUBE35000 Remote Key and can be operated from there.



Standard:

All actuators are triggered (e.g. sirens) and all cameras are recording



Standard:

All cameras are recording



Note

When pairing components, standard values are automatically set for the pre-configured hotkeys. Should you wish to alter the component settings for the hotkey in question, you can find the settings under point 5.3, Hotkeys.

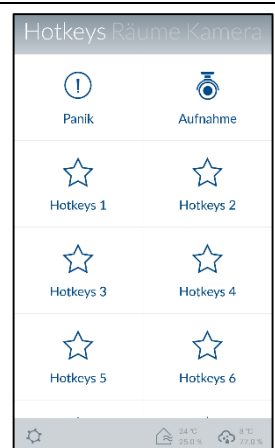

Configurable hotkeys

You can configure up to nine hotkeys in the settings (see chapter 5.3, Hotkeys). Once created, these are then shown in the hotkey overview and can be tapped and run.



Configured hotkeys

4.4. Rooms

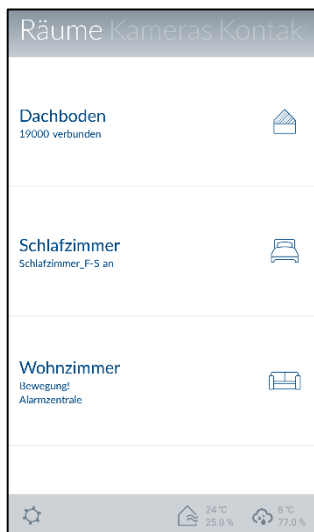

Room overview

In the room overview, all rooms with at least one added component are shown. A maximum of two components are shown under the room name.

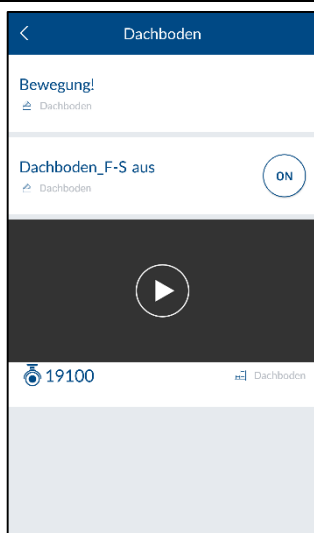

Room details

Tap the desired room to open the individual room overview. All components which have been added to the room are then listed.

Tap the arrow  in the top left-hand corner to exit the individual room overview.

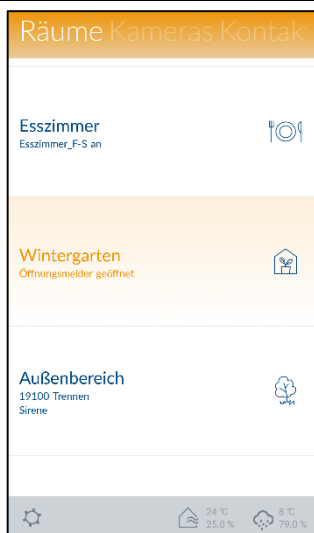

Colour code

If there is a fault with any of the individual components, the relevant room in the overview and the component itself will be marked in yellow.

4.5. Cameras

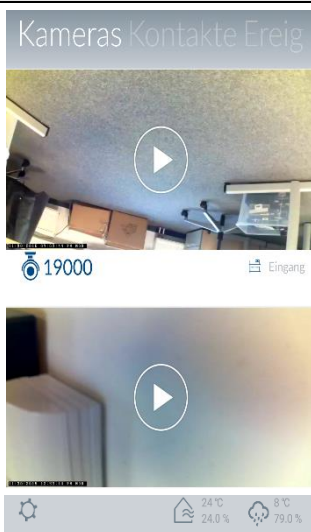

Camera overview

Up to four cameras can be displayed in the camera overview. In the settings (see chapter 5.5, Advanced settings), you can add four cameras in the contact overview or edit the settings for the cameras already available.

You can access the live view with the various camera functions by tapping the relevant camera.

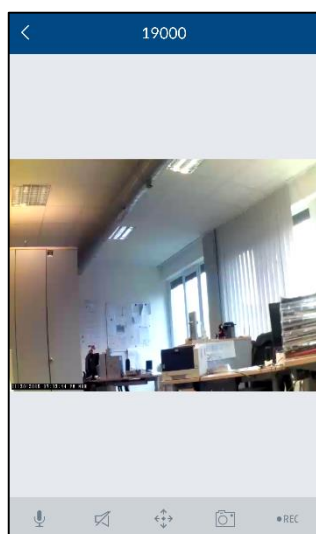

TVAC19000

Live view

You can control the camera by using your finger to swipe left, right, up or down across the live view.

Move two fingers away from each other on the screen to zoom in on the camera image.

Actions



Push to Talk

Keep this button pressed to speak to people on-site via the camera's loudspeaker.



Activate microphone

Tap this button to listen to the camera's recorded audio.



Preset positions

Press this button to save or retrieve positions that have just been set (Preset 1, 2, 3).



Snapshot

Tap this button to save a snapshot on your end device.



Recording

Press this button to start a one-minute recording.



Note:

Recordings are only possible if a microSD card has been inserted in the camera. The "Rec" button will not appear otherwise.



TVAC19100

Live view

Move two fingers away from each other on the screen to zoom in on the camera image.

Actions



Activate microphone

Tap this button to listen to the camera's recorded audio.



Snapshot

Tap this button to save a snapshot on your end device.



Recording

Press this button to start a one-minute recording.

Note:

Recordings are only possible if a microSD card has been inserted in the camera. The "Rec" button will not appear otherwise.



TVAC16000

Live view

Move two fingers away from each other on the screen to zoom in on the camera image.

Changing camera

Select the required camera (camera 1–4).

Actions



Snapshot

Tap this button to save a snapshot on your end device.

Recording



Press this button to start a one-minute recording.

Note:

Recordings are only possible if a microSD card has been installed in the TVAC16000 monitor. The "Rec" button will not appear otherwise.



4.6. Contacts

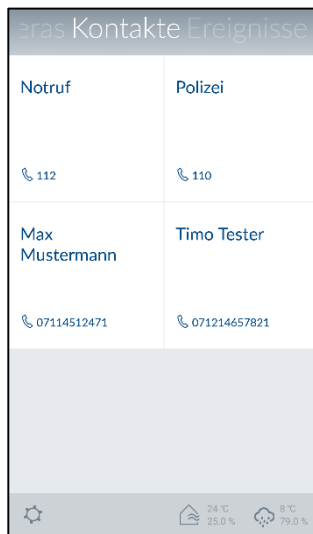

Contact overview

Up to four contacts can be displayed in the contact overview. Two pre-configured contacts – emergency and police – are already stored upon initial start-up. In the settings (see chapter 5.6, Contacts), you can add two further contacts in the contact overview or edit the contacts already available.

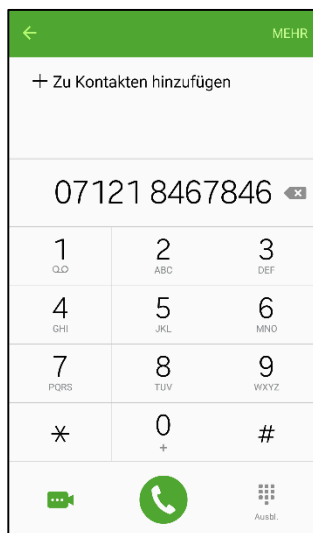

Make calls

Tapping a contact's number automatically brings up the telephone view for your end device, with the relevant contact's number pre-dialled. To make the call, you need to tap your end device's call button.



Attention

The pre-configured contacts – emergency and police – are only to be used in case of emergency.

4.7. Basic event



Event overview

When calling up the event list, the 100 most recent events are displayed.

To view older events, use the search function. The Smartvest alarm control panel stores a maximum of 1000 entries.



Note

Camera events will be loaded directly from the camera into the event overview and updated. Depending on the network connection, it may take several minutes for a new video to be displayed.



Note

Motion detector events are not listed in the event overview.

Use test mode to carry out the function test. (See chapter 1.4., Motion detector.)



Colour code



Components which have triggered an alarm status are marked red in the event overview.

Components not transmitting a signal to the Smartvest or whose battery is dead are marked yellow in the event overview.

Export

Tap the export symbol  in the bottom left-hand corner to save the current event overview on your end device in a text file.

Search

Tap the search symbol  in the bottom left-hand corner in order to search events within a specific time period. Tap "Search" to carry out the search or the arrow symbol  to return to the event overview.



Updating manually

You can update the event list manually by swiping downwards. This is particularly helpful when loading camera events.

4.8. Alarm view



Alarm view

The alarm view opens when an alarm is triggered, if:

- the Smartvest App is already open
- the Smartvest App is opened after the alarm
- the Smartvest App is opened by tapping the alarm's push notification.

Chain of events

The chain of events shows you which event triggered the alarm (highlighted red), when the event triggered the alarm, and any events that have taken place since the alarm was triggered. Up to 5 events will be displayed.

Actions

The pre-configured hotkeys, panic and record, can be found under Actions.



Standard:

All actuators are triggered (e.g. sirens) and all cameras are recording



Standard:

All cameras are recording

Camera overview

You can access the live view with the various camera functions by tapping the relevant camera.

Emergency contacts

Contacts you have selected as emergency contacts are displayed here and can be called upon for assistance.

Tapping a contact's number automatically brings up the telephone view for your end device, with the relevant contact's number pre-dialled.



Attention

The pre-configured contacts – emergency and police – are only to be used in case of emergency.

Situation under control

Tapping the "Quit alarm" button will disarm the alarm and your system.

You can also quit the alarm and disarm your system by pressing the "Disarm" button on your remote key.

5. Configuration

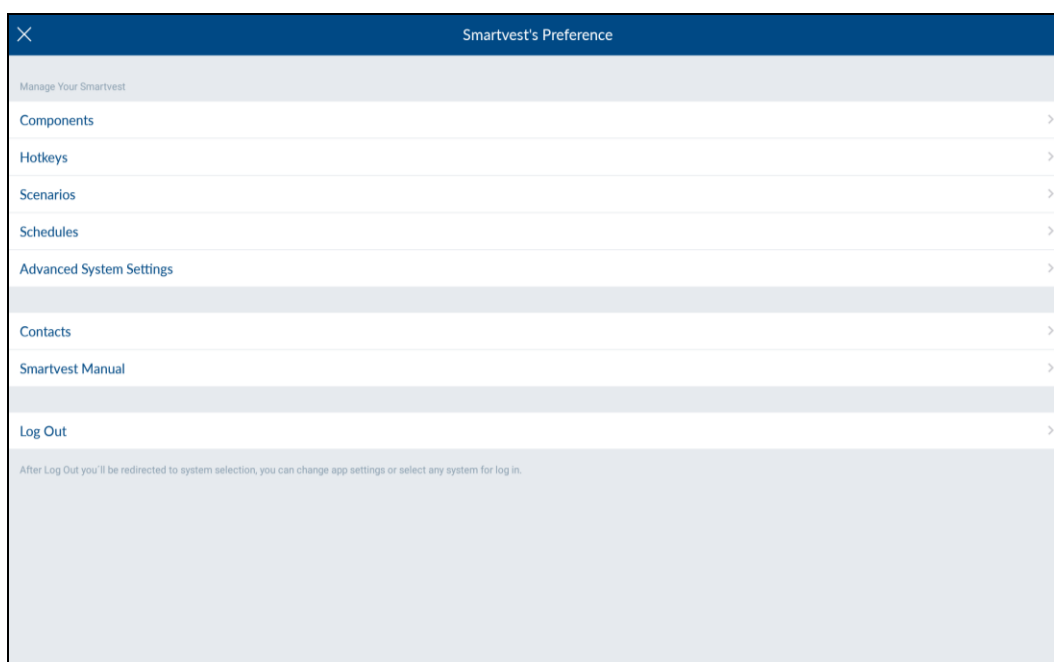

The Smartvest App is divided into two basic menus, operation and configuration.

This chapter will show you how to configure the Smartvest via the Smartvest App.

Please refer to chapter 4 to find out how to operate the Smartvest.

The following can be carried out via the configuration menu:

- setting and adding components
- setting your hotkeys
- setting your scenarios
- setting your schedules
- setting the network and security parameters
- setting the arm/partial arm/disarm modes
- setting the time and firmware
- activating the test, maintenance and remote mode.



Note

Depending on the operating system and end device used, the actual display may differ slightly from the screenshots included in this manual. In this manual, the menu overviews are illustrated using tablet screenshots, while the descriptions of the individual menu items are illustrated using smartphone screenshots. The descriptions of the menu items and navigation are however identical on each device.

5.1. Configuration overview

Configuration overview

The Smartvest settings, contacts and manual are displayed in the configuration overview.

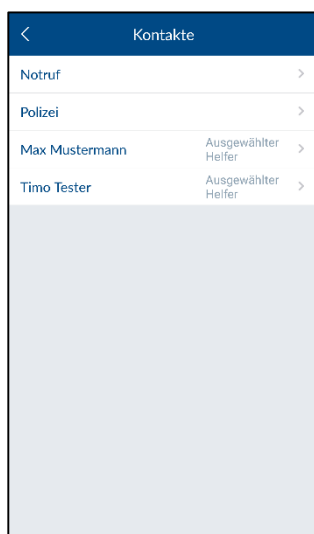
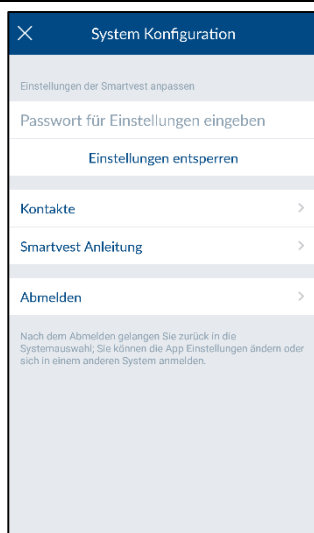

Smartvest settings

Enter the settings password (standard: "123456") to access all Smartvest settings options.

The settings password must be entered to change the following settings:

- Components
- Hotkeys
- Scenarios
- Schedules
- Advanced settings

These settings are described in greater detail in chapters 5.2 to 5.6.

Contacts

Tap "Contacts" to open the contact list.

The contacts displayed should be individually arranged for each end device as these are saved in the app itself.

Tap the contact that you want to change or tap the plus sign  to add a new contact.

Name

Enter a name for the contact.

Number

Enter the contact's telephone number

Selected helpers

Enable this option for the contacts you would prefer to inform in the event of an alarm. If you have designated at least one contact as a selected helper, this contact is displayed as a call option the next time there is an alarm on the Smartvest. Up to two of the four contacts can be designated as selected helpers.

New or amended contacts are shown in the contact overview (see chapter 4.6, Contacts).

Smartvest manual

Here you can access the Smartvest manual from your smartphone.

Log out

Tap "Log out" to stop the connection with Smartvest. You will then be taken to the homepage.

5.2. Components

Component overview

Tap "Components" to access the component overview. All paired components and the associated rooms are displayed in the overview.

Pair components

Tap the plus sign  to add a component. Select the relevant component from the component list.

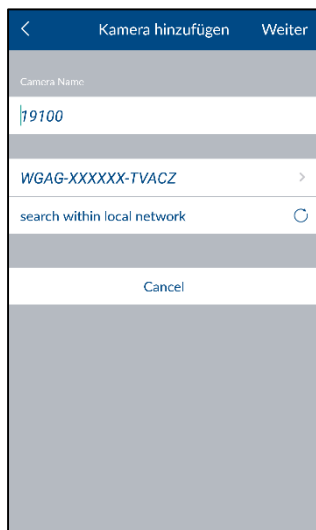

Camera



Note

If you have connected the camera to the same network as the Smartvest alarm control panel using a LAN cable, you can train the camera using the Smartvest app directly, as well as configuring it and then switching to WLAN operation.

To establish a direct WLAN connection, first follow the camera's instructions for setting up the camera on your home network.

- Enter a name for the component.
- Search for the camera within the network.
- Select the camera's DID from the results. Alternatively, enter the camera's DID manually and tap "Next".
- You now need to enter the camera's security code.
- Open the room list and select the room where the component is installed. Tap the arrow  to return to the settings.
- Tap "Next" to complete the pairing process.

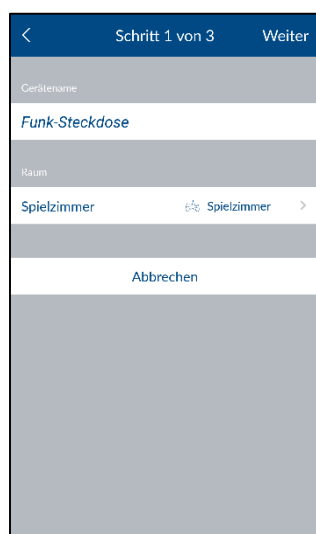







Wireless Socket

- Enter a name for the component.
- Open the room list and select the room where the component is installed. Tap the arrow  to return to the settings.
- Now tap "Next".
- Follow the instructions in the app and then complete the process.

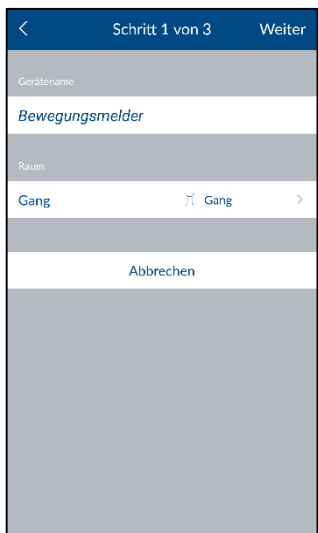

Note

	<p>If the pairing process was not successful, repeat the steps.</p>
	<p>Opening detector</p> <ul style="list-style-type: none"> • Enter a name for the component. • Open the room list and select the room where the component is installed. Tap the arrow  to return to the settings. • Now tap "Next". • Follow the instructions in the app. <p> Note If the pairing process was not successful, tap "Pair", open the magnetic contact's battery compartment and then close it again.</p>
	<p>Motion detectors</p> <ul style="list-style-type: none"> • Enter a name for the component. • Open the room list and select the room where the component is installed. Tap the arrow  to return to the settings. • Now tap "Next". • Follow the instructions in the app and then complete the process. <p> Note If the pairing process was not successful, tap "Pair", press the catch on the underside of the motion detector, remove the motion detector from the housing rear panel and press the pair button.</p>
	<p>Smoke alarm/heat detector</p> <ul style="list-style-type: none"> • Enter a name for the component. • Open the room list and select the room where the component is installed. Tap the arrow  to return to the settings. • Now tap "Next". • Follow the instructions in the app and then complete the process.

**Note**

If the pairing process was not successful, tap "Pair", loosen the smoke alarm/heat detector from the base plate, remove and replace the batteries.

Siren

- Enter a name for the component.
- Open the room list and select the room where the component is installed. Tap the arrow  to return to the settings.
- Now tap "Next".
- Follow the instructions in the app and then complete the process.

**Note**

If the pairing process was not successful, tap "Pair" and press the pair button on the back of the siren.

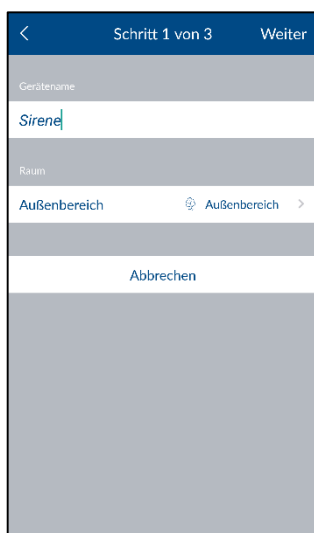
**Remote control**

- Enter a name for the component.
- Open the room list and select the room where the component is installed. Tap the arrow  to return to the settings.
- Now tap "Next".
- Follow the instructions in the app and then complete the process.

**Note**

If the pairing process was not successful, tap "Pair" and press the camera hotkey on the Remote Key for five seconds.

Configure components

Select the components you want to configure from the component overview.

The screenshot shows the configuration interface for an alarm panel. At the top, there are navigation arrows and the title 'Alarmzentrale' with a 'Speichern' button. The settings are as follows:

- Name:** Smartvest
- Hintergrund LED:** aus
- Lautstärke:** aus
- Reaktionsdauer:** 30 sek (selected)
- Raum:** Wohnzimmer
- Stadt:** Affing@Bavaria@Germany

Alarm panel

Name

Enter a name for the Smartvest.

Background LED

Adjust the brightness of the background LED to "Off", "Low" or "High".

Volume

Adjust the alarm panel's volume to "Off", "Low" or "High" for alarming or other events.

Off

Low: 70 dB

High: 90 dB

Duration of the reaction

Set the alarm duration for the alarm control panel in the event of an alarm.

Room

Open the room list and select a room where the Smartvest is mounted. Tap the arrow  to return to the settings.

Town

To display weather information, tap the town row and search for your location using the place name or postcode and select your location from the results returned.

The screenshot shows the configuration interface for a wireless socket. At the top, there are navigation arrows and the title 'Funk-Steckdose' with a 'Speichern' button. The settings are as follows:

- Name:** Dachboden_F-S
- Automatisches Ausschalten nach dem Szenario:** Kein
- Raum:** Dachboden

Wireless Socket

Name







Enter a name for the component.

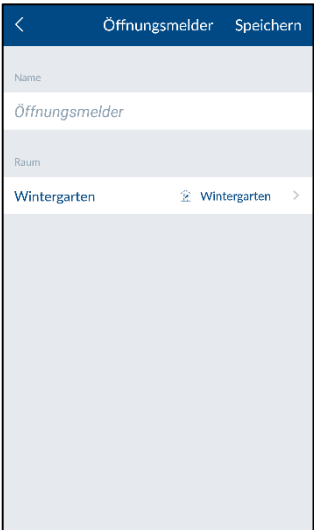

Auto off after scenario

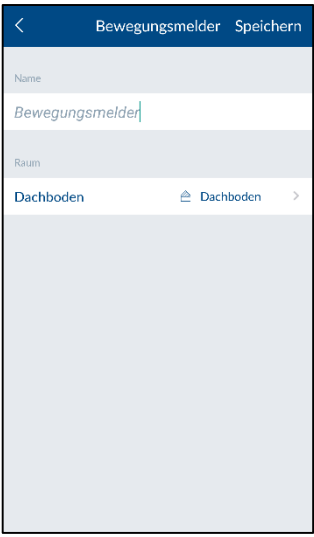
Specify how long the power switch should remain activated after a scenario has been activated.

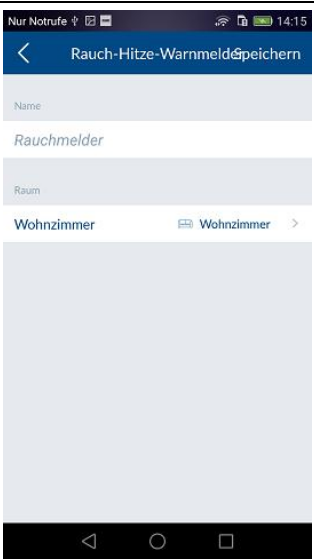
Room

Open the room list and select the room where the wireless socket is installed. Tap the arrow  to return to the settings.

	<p>Opening detector</p> <p><u>Name</u> Enter a name for the component.</p> <p><u>Room</u> Open the room list and select the room where the opening detector is installed. Tap the arrow  to return to the settings.</p>
	<p>Motion detectors</p> <p><u>Name</u> Enter a name for the component.</p> <p><u>Room</u> Open the room list and select the room where the motion detector is installed. Tap the arrow  to return to the settings.</p>
	<p>Smoke alarm/heat detector</p> <p><u>Name</u> Enter a name for the component.</p> <p><u>Room</u> Open the room list and select the room where the component is installed. Tap the arrow  to return to the settings.</p>
	<p>Siren</p> <p><u>Name</u></p>

	<p>Enter a name for the component.</p> <p><u>Type of reaction</u> Here you can set how the siren reacts when it is activated.</p> <table border="0"> <tr> <td>LED</td> <td>LEDs flashing</td> </tr> <tr> <td>Sirene</td> <td>Siren is activated</td> </tr> <tr> <td>LED and siren</td> <td>LEDs are flashing and siren is activated</td> </tr> </table> <p><u>Duration</u> Here you can set how long the siren sounds and how long the LEDs flash when activated.</p> <p><u>Volume</u> Set the siren volume. Off Low: approx. 80 dB High: approx. 100 dB</p> <p> Attention Always maintain a distance of 3 m when the volume is set to 100 dB in order to prevent physical injury (e.g. to hearing).</p> <p><u>Room</u> Open the room list and select the room where the Smartvest is installed. Tap the arrow  to return to the settings.</p>	LED	LEDs flashing	Sirene	Siren is activated	LED and siren	LEDs are flashing and siren is activated
LED	LEDs flashing						
Sirene	Siren is activated						
LED and siren	LEDs are flashing and siren is activated						
	<p>Remote control</p> <p><u>Name</u> Enter a name for the component.</p> <p><u>Room</u> Open the room list and select a room where the Smartvest is mounted. Tap the arrow  to return to the settings. The "Mobile devices" room is available for the Remote Key.</p>						

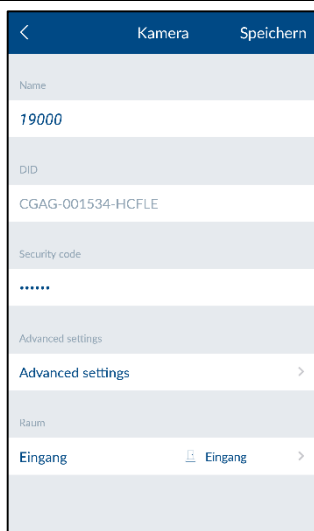

Camera

Name

Enter a name for the component.

DID

Read the camera's DID number here.

Security code

Entering the camera's security code

Advanced settings

Open the advanced settings by entering the camera's admin code (default setting: 123456).

Room

Open the room list and select the room where the camera is installed. Tap the arrow  to return to the settings.

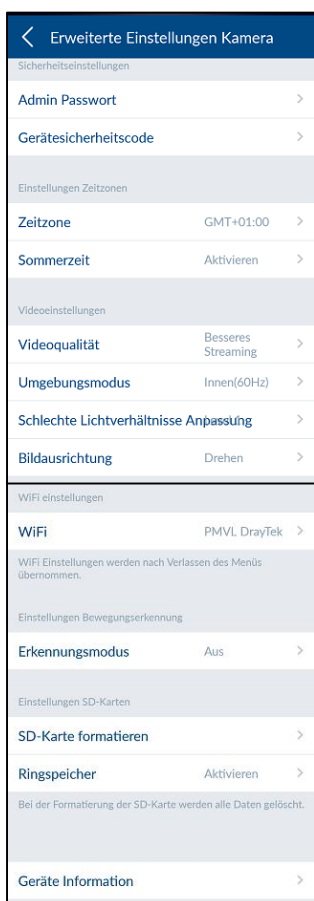

Advanced camera settings

(not available for TVAC16000 cameras)

Admin password and device security code

Change the device security code and password for the camera here

The device security code provides you with access to the camera image

The admin password opens the advanced settings.

Time zone settings

Here you can select the time zone in which the camera is installed. If the world time zone uses summer time, activate the summer-time setting.

Video Settings

Video Quality

Select the quality for the video streaming here.

- Improved streaming, the video display is smoother.
- Improved image, the video image has a higher resolution.
- HD video, the video image is shown in HD. However, due to the large volume of data, the image may be delayed.



Note:

Only use the improved image/HD video settings if you have sufficient bandwidth (1 Mbps) and the correct system requirements. Note that differing transmission technologies for audio and video may result in asynchronous transmission as a result of different network traffic.

Environment mode

- Here, you have the option to choose between the interior (50 Hz), interior (60 Hz) and exterior network frequency.
- Standard value, Germany: 50 Hz

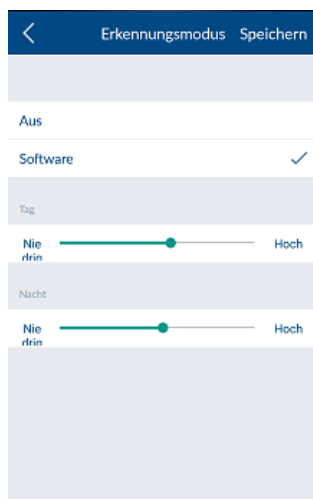

Adjusting for poor light conditions

If light conditions are poor in night mode, adjust the video image using the 5 levels. Level 5 brightens the image as far as possible.

Image alignment

Here you can rotate, mirror, or rotate and mirror the image.

WiFi settings

Select the required network that will be used for the camera to access the Internet and enter the correct WLAN password.



Note:

To prevent unauthorised persons from accessing the network, protect it using WPA/ WPA2/ WPA2-PSK encryption.



Once the settings have been saved, the camera restarts. Do not forget to disconnect the Ethernet adapter cable (if used during initial commissioning).



If the connection was unsuccessful or incorrect WiFi details were entered, press and hold the reset button for 5 seconds to reset the camera to its default settings.

Recognition mode

The settings for motion detection are required for motion-detection-based recording.

You can choose between "Off" and "Software".

- Off: No notification/recording in the event of motion being detected.
- Software: The camera's software detects motion.

You can specify different degrees of sensitivity for the motion detection at night and during the day. The higher the sensitivity, the smaller the movement must be on the image for the motion detection to be triggered.

SD card settings

Formatting the SD card

Format the SD card. To use an SD card continuously, please use a class 10 SD card.



Note:

When formatting the SD card, all data will be deleted. Please save the data before formatting.

Activating the circular buffer

If this function is activated, the newest recordings overwrite the oldest ones once the SD card is full.

Device information

Here you can read the firmware version, as well as the total storage and available storage space.

5.3. Hotkeys

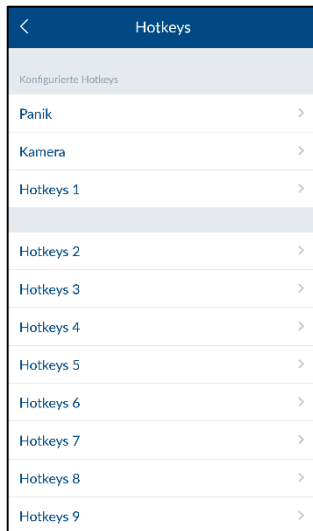

Hotkeys

Tap the configured hotkeys (panic or camera) or one of the nine configurable hotkeys in order to configure these. Configured hotkeys are separated from non-configured hotkeys by a blank line.

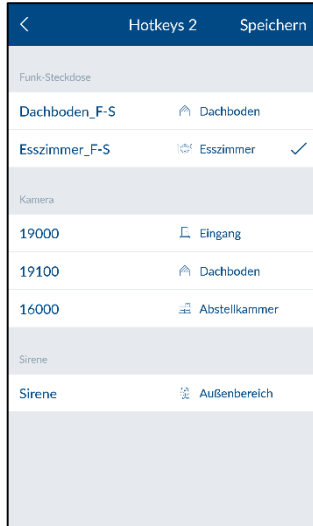

Hotkey settings

In the list of actuators, select the components you would like to be activated when the hotkeys are tapped.

Tap "Save" to create the hotkey with the desired actuators.

The hotkey will then be visible in the hotkey overview (see chapter 4.3, Hotkeys) and can be tapped and activated.

5.4. Scenarios

Application examples

Scenarios allow you to automate certain actions in your home;

for example, you can use a motion detector when a room is entered or a magnetic contact when a door is opened to switch on a light source connected to a power switch.

You could also use a motion detector or magnetic contact to start a camera recording, which allows you to always have an overview of who has entered your house and when.

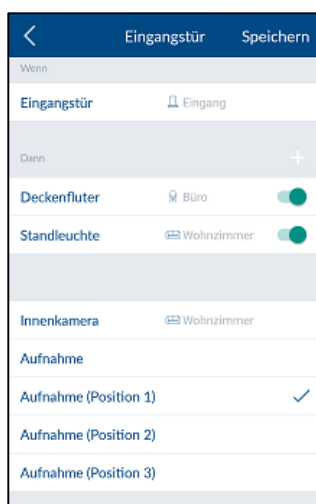

Scenarios

In the list of sensors, select the components to which you would like to add a scenario.

Any number of actuators can be assigned to each sensor.

You can also manually deactivate existing configured scenarios using the ON/OFF switch on the right-hand side of the components until you want to reactivate them.

Scenario settings

Tap the plus sign  to open the list of actuators. Select one or more actuators that you want to add to the sensor's scenario and tap "Save".

For power switches, you also need to select whether the power switch activates when the scenario is activated ("On") or deactivated ("Off").

By setting the TVAC19000 pan/tilt camera as an actuator, you can start a recording from 1 of 3 preset positions.



Note:

You can remove an actuator from the list by removing it from the actuator list (uncheck it).



Note:

Please make sure that no scenarios conflict with the configuration in the event of an alarm.

Example:

If a motion detector detection switches on a radio socket in the event of an alarm, you should not create any scenario with this motion detector involving switching off the same radio socket.

5.5. Schedules

Application examples

Schedules allow you to automate certain actions in your home as well as providing presence simulation.

You can store schedules for each power switch to activate light sources that are connected to a power switch and simulate a presence when you are away, while on holiday for example.

You could also connect your Christmas lights to a power switch and activate these at night-time only using a schedule.

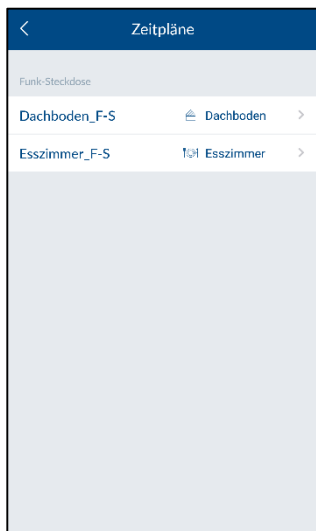

Schedules

In the list of power switches, select the power switches for which you would like to store a schedule.

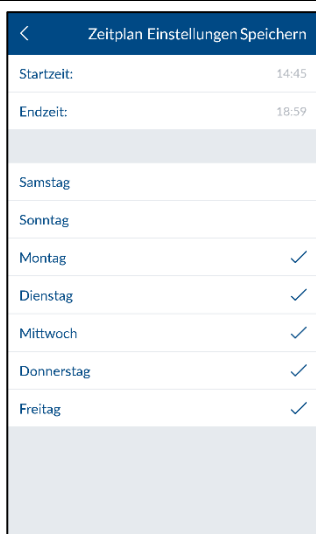

Schedule settings

Tap the plus sign  to add a schedule.

Select the start and end time for when you would like the power switch to be activated.

Select the days of the week on which you would like the schedule to be followed.



Note

You can create up to ten schedules for each power switch.

5.6. Advanced settings

NetzwerkeinstellungenSpeichern

DHCP

IP Adresse
192.168.0.50

Subnetzmaske
255.255.255.0

Gateway
192.168.0.1

DNS Server
192.168.0.1

Network settings

The Smartvest is set to DHCP by default. This means that the Smartvest is automatically assigned an IP address, subnet mask, gateway and DNS server by your router.

Should you wish to enter these manually, switch DHCP to "Off" and enter your own details.



Note

We recommend leaving the DHCP function set to "On".

IP address

For the IP addresses available for the Smartvest IP address, refer to your router settings.

Subnet mask

The subnet mask is dependent on the network to which you are connected. The standard subnet mask is: 255.255.255.0.

Gateway and DNS server

For the gateway and DNS server, you usually enter your router's IP address.



Example of a manual entry:

IP address:	192.168.0.50
Subnet mask:	255.255.255.0
Gateway:	192.168.0.1
DNS server:	192.168.0.1

To complete the process, tap "Save" to store the details.

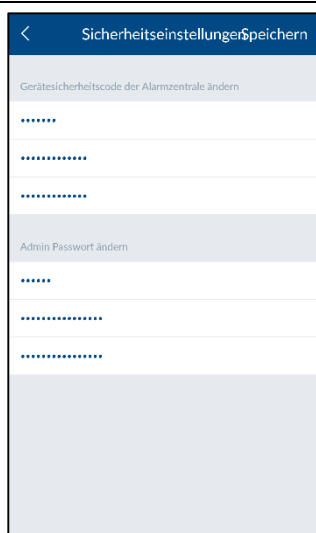

Security settings

In the security settings, you can change the security code and password for the Smartvest settings. It is strongly recommended that you change both passwords when performing the initial setup.

Device security code

Enter the old security code followed by the new one. Confirm this again, then tap "Save".



Note

The security code is automatically changed in the end device central settings where the change was carried out.

With other end devices, you must change the device security code in the general settings (see point 2.4, General settings) before you log in next time.

Password for settings

Enter the old password for the settings and then the new password for the settings. Confirm this again, then tap "Save".



Note

If you have forgotten your security code or your password for the settings, you can reset these to the standard value "123456".

To do this, press the reset button on the Smartvest using a paper clip for ten seconds (while operating); this will restore the Smartvest's factory settings. This safeguards the pairing with the components and ensures the most important settings are retained.



Status configuration

Select the status you would like to configure. This is how you specify how your Smartvest will react in the relevant status.

Activated

Select the actuators and sensors you would like to trigger and/or detect in "Active" status.



Exit delay

Activate the exit delay so you have enough time to leave the house after arming the Smartvest. The exit delay applies for both "Active" and "Part set".



Note

In "Active" status, all actuators and sensors are activated as standard.

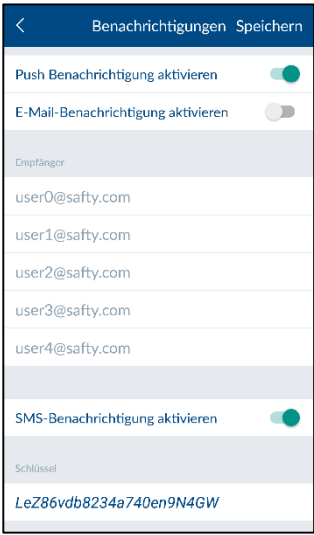
	<p>Part set Select the actuators and sensors you would like to trigger and/or detect in "Part set" status.</p> <p>Exit delay Activate the exit delay so you have enough time to leave the house after arming the Smartvest. The exit delay applies for both "Active" and "Part set".</p> <p> Note In "Part set" status, all actuators and sensors are activated as standard, with the exception of motion detectors.</p> <p>Deactivated</p> <p>Entry delay Activate the entry delay so you have enough time to disarm the Smartvest when entering the house.</p> <p> Attention The entry delay carries an increased security risk as the alarm panel can be tampered with during this time period.</p>
	<p>Notifications</p> <p><u>Use push notification</u> Enable push notification in order to be notified on your end device when there is a status change or an alarm.</p> <p><u>Enable email notification</u> Enable email notification in order to be notified on your end device when there is a status change or an alarm.</p> <p>To do this, enter your email address(es) in the recipient list.</p>

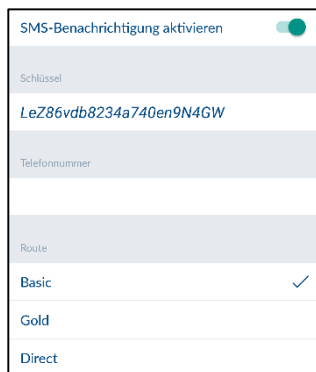

Enable SMS notification

Enable SMS notification in order to be notified on your end device when there is a status change or an alarm.

For SMS notification, go to www.smstrade.de and order a subscription that suits you. After registering, you will receive a verification request on your mobile. Confirm this,

then enter the key and your telephone number and select the desired program.



Attention

"SMS Service" is a product offered by CM Telecom Germany GmbH, Office Frankfurt, Mainfrankenpark 53, 97337 Dettelbach. The service is used at your own risk. ABUS Security-Center GmbH & Co. KG, Linker Kreuthweg 5, 86444 Affing, Germany shall not assume any liability for any possible damage caused as a result of using the service.



Firmware update

Tap "Update" to start the firmware update.

Please wait until the message "Update completed" is displayed. – The alarm control panel then restarts. The network LED flashes red during the boot process.



Note

Any firmware update should ideally be carried out on the same network as the Smartvest.

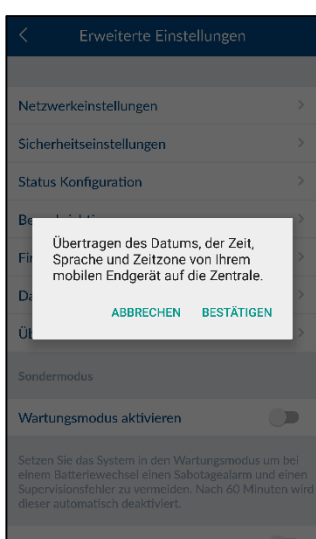





Adopt time

Tap "Adopt time" to transfer the current time zone and time from your smartphone to the Smartvest.

About

Tap "About" to view up-to-date information on the Smartvest DID, the current firmware version and the current app version.

	
	<p>Special mode</p> <p><u>Maintenance mode</u></p> <p>Set the system to maintenance mode to avoid triggering the tamper alarm and a supervision fault when changing the battery.</p> <p> Attention Do not forget to deactivate maintenance mode again for normal operation.</p> <p><u>Test mode</u></p> <p>After activating test mode, a view appears showing all new events including motion detection. Test mode is only available if the system is disarmed.</p> <p> Attention Do not forget to deactivate test mode again for normal operation.</p> <p><u>Remote mode</u></p> <p>In "Remote Mode", app functionality is limited to Remote Key functions. This is suitable for users who should only be given access to the basic functions e.g. children.</p>

6. Technical data

Model number		FUAA35000 – Smartvest
Battery		6 x AA (2 x 3) (1.5 V) as a backup power supply
Battery life	h	Ø 5
Operating temperature	°C	0–40
Frequency	MHz	868,3
Weight	g	540
Hygrometer		integrated
Dimensions	mm	279.6 x 89.3 x 193.8
Max. wireless zones		32
Max. humidity	%	80
Installation		Free-standing or wall installation
Network connector	Mbit	10/100
Range	m	approx. 30 depending on the local conditions
Sound pressure	dB	Off, low (70), high (90)
Power supply	V	5
Power consumption	mA	Max. 450

Model number		FUHA35000 – power switch
Connections		Safety plug on device (type: F); safety plug on device (type: F)
Operating temperature	°C	0–40
Frequency	MHz	868
Weight	g	129
Dimensions	mm	55 x 99 x 31
Max. humidity	%	80
Range	m	approx. 30 depending on the local conditions
Tamper monitoring		No
Switching power	W	< 3680
Signal check		Yes, time interval 3 h
Power supply	V	250 AC

Model number		FUMK35000 – magnetic contact
Battery		1 x CR2032 (3V)
Battery life	h	Ø 1 year
Operating temperature	°C	0–40
Frequency	MHz	868,3
Weight	g	30
Dimensions	mm	40 x 71 x 14
Max. humidity	%	80
Installation		Door or window installation
Range	m	approx. 30 depending on the local conditions
Tamper monitoring		Yes
Signal check		Yes, time interval 3 h

Model number		FUBW35000 – PIR Motion Detector
Battery		3 x AA (1.5 V)
Battery life	h	Ø 2 years
Operating temperature	°C	0–40
Type of detection		Heat recognition
Energy saving mode	s	120 (after motion is detected, the motion detector will wait 120 seconds before sending another alert)
Detection range	m	16
Frequency	MHz	868,3
Weight	g	163
Dimensions	mm	61 x 110 x 52
Max. humidity	%	80
Installation		Wall installation Height > 2 m
PIR angle of view		Horizontal: 105° Vertical: 45°
Range	m	approx. 30 depending on the local conditions
Tamper monitoring		Yes
Signal check		Yes, time interval 3 h

Model number		FURM35000 – smoke alarm/heat detector
Alarm muting	m	10
Battery		2 x AA (1.5 V)
Battery life	h	Ø 1 year
Operating temperature	°C	0–45
Detection range	m ²	40
Frequency	MHz	868,3
Weight	g	166
Dimensions	mm	32 x 120
Max. humidity	%	93
Installation		Ceiling installation
Range	m	approx. 30 depending on the local conditions
Signal check		Yes, time interval 3 h

Model number		FUSG35000 – siren
Battery		4 x C (1.5 V)
Battery life	h	Ø 2 years
Operating temperature	°C	-10–50
Frequency	MHz	868,3
Weight	g	870
Luminous colour		Red
Illuminant		LED
Dimensions	mm	112 x 300 x 102
Max. humidity	%	80
Installation		Wall installation in protected outdoor area.
PIR angle of view		Horizontal: 105°, vertical: 45°
Range	m	approx. 30 depending on the local conditions
Tamper monitoring		Yes
Sound pressure	dB	Off, low (80), high (100)
Protection class	IP	44
Signal check		Yes, time interval 3 h
Power supply	V	5
Power consumption	mA	200
Model number		FUBE35000 – Remote Key

Battery		1 x CR2032 (3V)
Battery life	h	Ø 2 years
Operating temperature	°C	0–40
Frequency	MHz	868,3
Weight	g	22
Dimensions	mm	30 x 60 x 14
Max. humidity	%	80
Installation		Door or window installation
Range	m	approx. 30 depending on the local conditions
Tamper monitoring		No
Signal check		Yes, time interval 3 h