



**Zakład Mechaniki i Elektroniki  
ZAMEL sp.j.**  
J.W. Dzida, K. Łodzińska

**zAMEL**

ul. Zielona 27, 43-200 Pszczyna, Poland  
Tel. +48 (32) 210 46 65, Fax +48 (32) 210 80 04  
[www.zamelcet.com](http://www.zamelcet.com), e-mail: [marketing@zamel.pl](mailto:marketing@zamel.pl)

### DESCRIPTION

The ASP-02 staircase timer is designed for corridor and staircase lighting control. After the circuit triggering the timer keeps the light ON for the preset time and then switches it OFF. It has an adjustable ON-time setting of 10 seconds to 14 minutes. ON-time may be adjusted by means of a potentiometer. The timer is fitted with a counter-interlock circuit. The ASP-02 staircase timer may be applied as a time relay for delayed switch-OFF. It is possible to mount the device under a push button, in a deep junction box of 60 mm diameter.

### FEATURES

- ☞ Staircase lighting control,
- ☞ Continuous ON-time adjustment of 10 seconds to 14 minutes,
- ☞ Relay state indicator – red LED,
- ☞ Device triggering by means of the L or N wire,
- ☞ Applicable together with the single pole push buttons, illuminated,
- ☞ Easy applicable together with any existing electrical system,
- ☞ Counter-interlock function,
- ☞ Relay voltage output, maximum load 5 A.



The device should be connected to a singlephase system accordingly to current standards. The device connection will be described in this manual.

Only qualified electricians are allowed to connect, assembly and adjust the timer. It is necessary to read this manual before the timer mounting. Do not disassembly the timer casing or you will lose any warranty rights and expose yourself to the electric shock hazard. Before mounting operation make sure of disconnecting the connection wires from the electric network. Use a cross-head screwdriver of 3.5 mm diameter to mount the device. The timer should be carried, stored and used in an appropriate way. Do not mount the timer in case of any device parts lack, damage or deformation. In case of malfunction please notify the manufacturer.

### TECHNICAL DATA

#### ASP-02

Power supply cables:	L(black), N(blue)
Input rated voltage:	230 V~
Input voltage tolerance:	from -15 to +10 %
Nominal frequency:	50 / 60 Hz
Rated power consumption:	10,5 mA
Release cable:	IN (red)
Output cable:	(P) brown
Time adjustment range:	from 10 s to 14 min
Time accuracy adjustment:	±10 %
Time repeatability adjustment:	±5 %
Time adjustment:	continuous (rotational potentiometer)
Load supply indicator:	red LED
Control:	relay 5 A / 250 V AC1 1250VA
Number of switch cables:	4
Section of connecting cables:	1 mm <sup>2</sup>
Connecting cable length:	10 cm
Ambient temperature range:	from -20 to +45 °C
Operating position:	free
Mounting:	for 60 mm junction box
Protection degree:	IP20
Protective class:	II
Overvoltage category:	II
Pollution degree:	2
Dimensions:	50 x 50 x 15 mm
Weight:	28 g
Reference standards:	PN-EN 60669-1; PN-EN 60669-2-1 PN-EN 61000-4-2,3,4,5,6,11

### APPERANCE

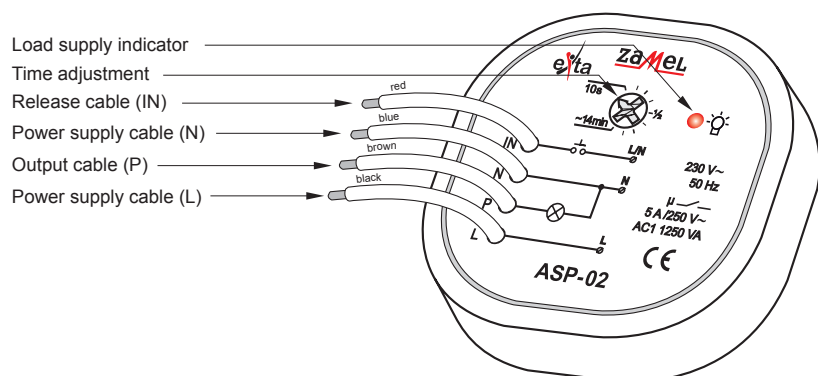

## MOUNTING

1. Disconnect the electric network by means of an appropriate cut-off, current limiting circuit-breaker or separator.
2. Check if there is no any voltage between power leads by means of an appropriate gauge.
3. Place the ASP-02 timer in a junction box and connect leads accordingly to electrical diagram.
4. Connect power supply circuit.
5. Adjust the light ON-time required by means of the potentiometer.

## CONNECTING

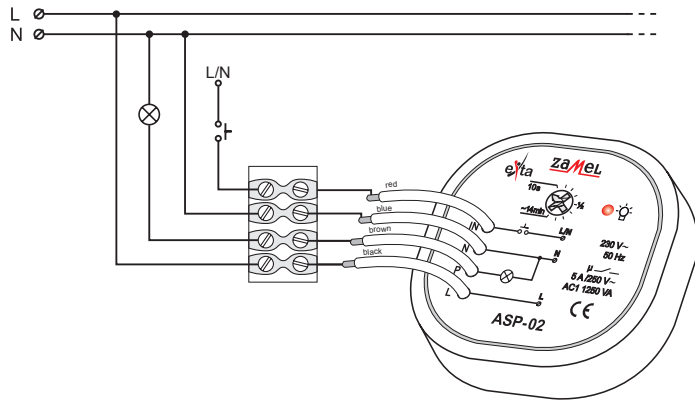

## FUNCTIONING

The timer is ready to work just right after its appropriate connecting. The light will be ON for the preset ON-time after the timer is triggered by means of a single pole push button. When the preset time is over, the light will be OFF automatically until the timer is triggered once again. The staircase timer may be connected either to three-conductor or four-conductor wiring. Check carefully if trigger and load circuits have been connected correctly. The timer may be damaged if connected inappropriately. In case of the counter-interlock circuit lack the light is continuously ON when the trigger push button is blocked.

## EXAMPLE OF INSTALLATION

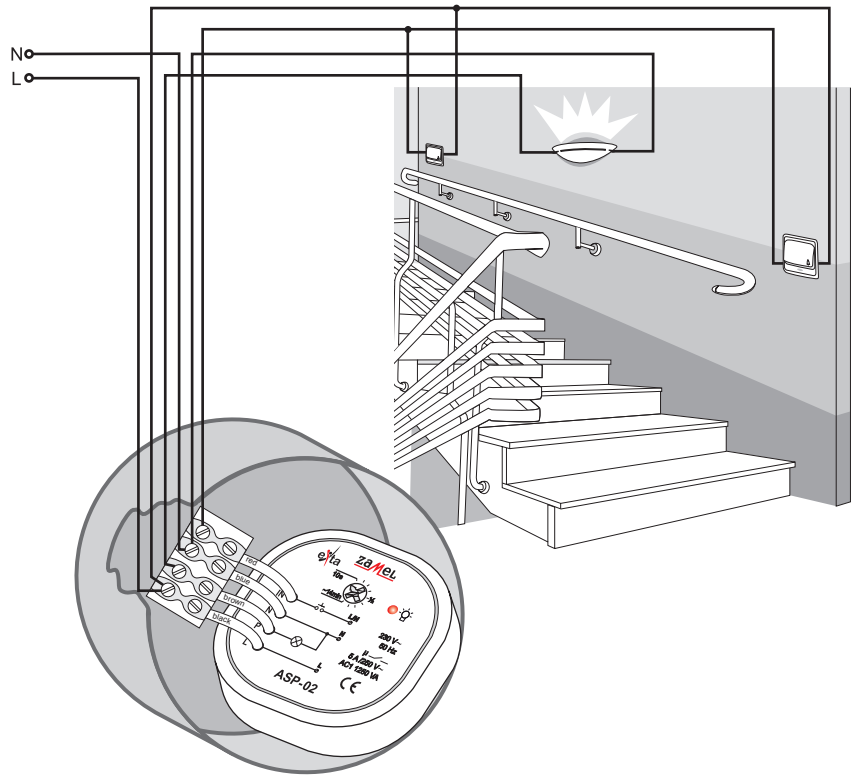

## INNER DIAGRAM

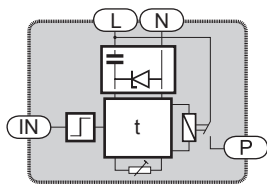

## DIMENSIONS

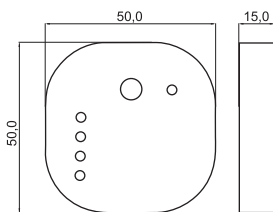

## TIME COURSE

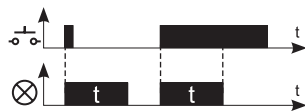

## RELAY CAPACITY

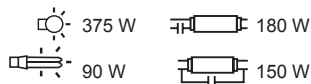

## PRODUCT FAMILY

The ASP-02 is a member of the ASx staircase timer family.

ASx - xx (/24V)

Version 24 V AC/DC  
for ASM-02 available

Device version:

- 01 – three- or four-conductor wiring
- 02 – anti-lock system
- 10 – dimmer function

Type of casing:

- M – monomodule
- N – surface mounting
- H – hermetical
- P – for junction box mounting

Device symbol