

BA 180806-7024

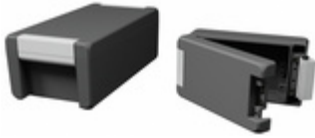

Bocube Alu
Enclosure with smooth lid, graphite grey, covers anodised, hinged

Order no.: 00114124

Colour of enclosure group

Graphite grey, similar to RAL 7024; light grey, similar to RAL 7035; special colours on request

Protection class

IP 66 / IP 67 / IP 69 DIN EN 60529

Enclosure material

Enclosure: GD Al Si 12, seal PU foamed; Hinges / covers: Al Mg Si 0.5 powder-coated / natural-coloured anodised

Scope of delivery: enclosure incl. hinge and fixing material

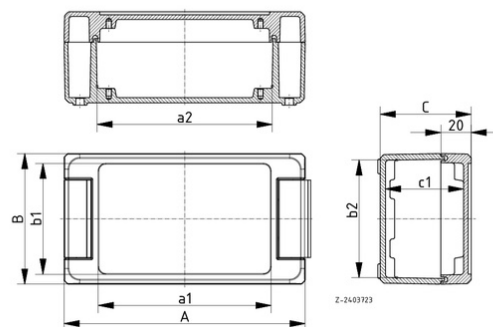

A	199 mm
B	86 mm
C	60 mm
a1	- mm
a2	155,5 mm
b1	- mm
b2	77,5 mm
c1	53,5 mm

Technical drawings

Catalogue drawing in DXF format:
[00114124_BA-180806-7024.dxf](#) (2.8 MB)
Catalogue drawing in PDF format:
[00114124_BA-180806-7024.pdf](#) (222 KB)
3D product data in STEP format:
[Registration necessary](#)
Basic drawing for processing work:
[00114124_BA-180806-7024-G.dxf](#) (2.1 MB)

Assembly instructions

[Bocube Alu_00911501.pdf](#) (127 KB)

Chapter download

[Bocube Alu_GB.pdf](#) (1.7 MB)

* = Available on request