

Typ : MDK20032036,8072

RoHS Compliant

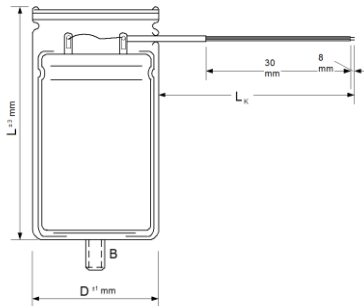

∅ D : 36,8 mm
 L : 72 mm
 L_k : 330 mm

B : M8 x 12

Terminals : wire

Max. torque:
 Stud: M8: 4,0 Nm, M12: 10,0 Nm

Electrical Parameters

Rated Capacitance (C _R) @ 100 Hz / 20 °C	20 μF	
Tolerance	± 10 %	
Rated Voltage (U _R)	320 V	
ED	1,7 %	
VDE approval	Yes	
Tan δ typ. @ 100 Hz / 20°C	4 %	
IEC Climatic category / Standards	10/60/21	DIN EN 60252-2
Applications	motor start	