

Drawing No. : 1016279
 created: SBR 15/12/2016 11:12:00

Page 1 / 1

Typ : MDK80032041,8085

RoHS Compliant

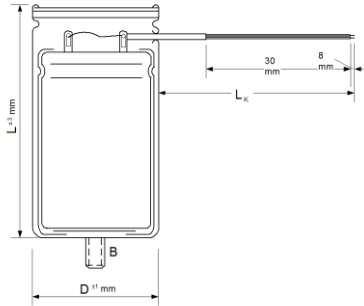

∅ D : 41,8 mm
 L : 85 mm
 L_k : 330 mm

B : M8 x 12

Terminals : wire

Max. torque:
 Stud: M8: 4,0 Nm, M12: 10,0 Nm

Electrical Parameters

Rated Capacitance (C_R)
 @ 100 Hz / 20 °C

80 μF

Tolerance

± 10 %

Rated Voltage (U_R)

320 V

ED

1,7 %

VDE approval

Yes

Tan δ typ.
 @ 100 Hz / 20°C

4 %

IEC Climatic category / Standards

10/60/21

DIN EN 60252-2

Applications

motor start