

FTCAP GmbH  
 Carl-Benz Str. 1  
 25813 Husum / Germany  
 Tel. +49 (0) 4841 8957 0  
 Fax. +49 (0) 4841 8957 45  
 Email info@ftcap.de

**FTCAP GmbH**  
**Preliminary Data sheet**



Drawing No. : 1016287  
 created: SBR 15/12/2016 11:15:00

Page 1 / 1

**Typ : MDK90032041,8085**

**RoHS Compliant**

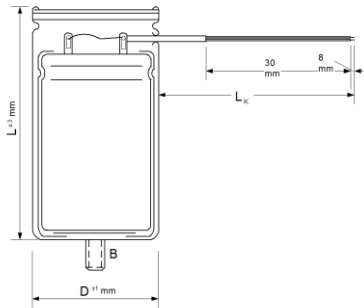

∅ D : 41,8 mm  
 L : 85 mm  
 L<sub>k</sub> : 330 mm

B : M8 x 12

Terminals : wire

Max. torque:  
 Stud: M8: 4,0 Nm, M12: 10,0 Nm

**Electrical Parameters**

Rated Capacitance ( C <sub>R</sub> ) @ 100 Hz / 20 °C	<b>90</b> μF	
Tolerance	<b>± 10</b> %	
Rated Voltage ( U <sub>R</sub> )	<b>320</b> V	
ED	<b>1,7</b> %	
VDE approval	<b>Yes</b>	
Tan δ typ. @ 100 Hz / 20°C	<b>4</b> %	
IEC Climatic category / Standards	<b>10/60/21</b>	<b>DIN EN 60252-2</b>
Applications	motor start	