

## 1.Scope

This specification is applied to Piezo Siren (Self-Drive Type)

The product describe below are used for buzzer in various alarm systems.

## 2.Basic Condition

2.1 Rated Voltage:24VDC

2.2 Operating Voltage:20~28VDC

2.3 Operating Temperature Range:-20 °C~+70 °C

2.4 Storage Temperature Range:-30°C~+80 °C

## 3.Electrical Characteristics

3.1 Sound Press Level: $\geq 100$ dB at 100cm / 24VDC

3.2 Consumption Current: $\leq 150$ mA at 24VDC

3.3 Resonate Frequency:2900Hz $\pm$ 500Hz

3.4 Tone Nature: Dual Sound

3.5 Material:ABS

## 4.Measuring Method

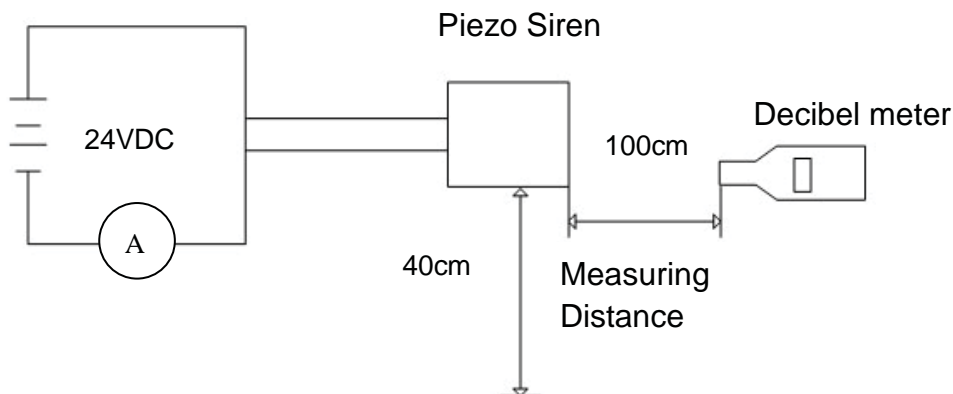

## 5.Sound Press Level & Consumption Current Curve

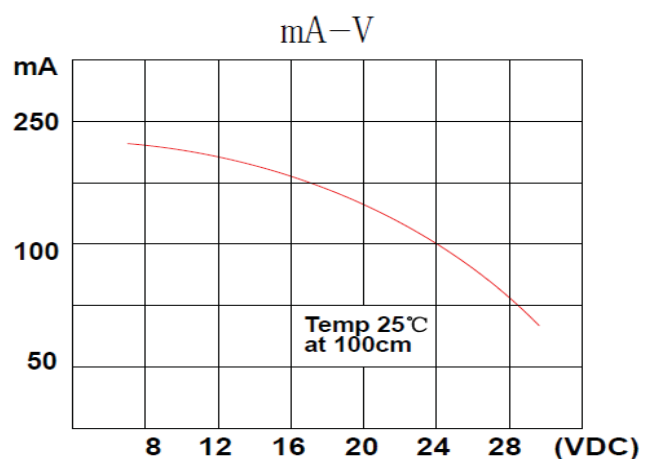
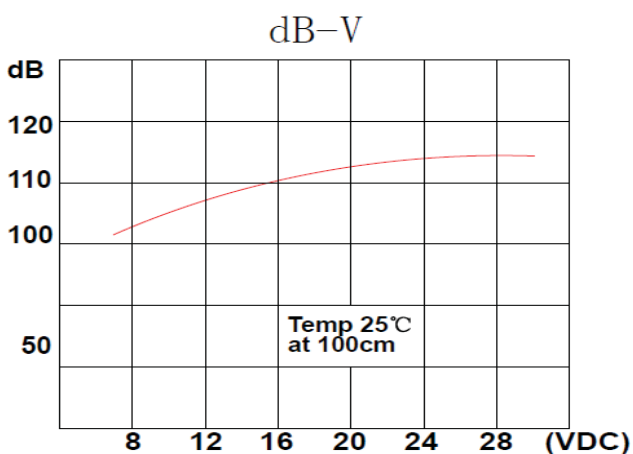

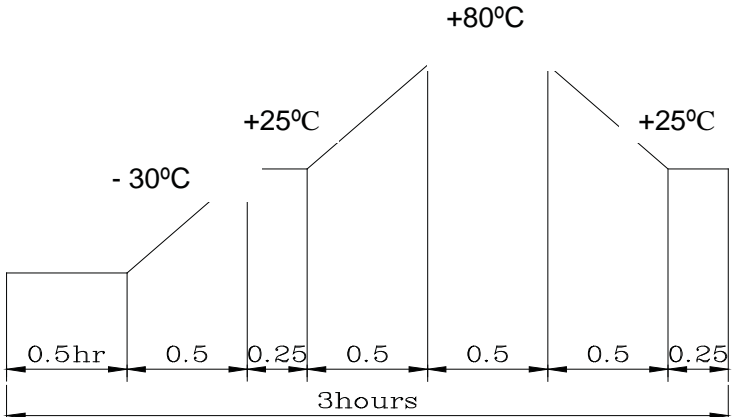

## 6.Environment Test Method

NO.	ITEM	TEST CONDITION AND REQUIREMENT
1	High Temperature Test (Storage)	After being placed in a chamber with $80\pm 2^{\circ}\text{C}$ for 96 hours and then being placed in normal condition for 2 hours. Allowable variation of SPL after test: $\pm 10\text{dB}$ .
2	Low Temperature Test (Storage)	After being Placed in a chamber with $-30\pm 2^{\circ}\text{C}$ for 96 hours and then being placed in normal condition for 2 hours. Allowable variation of SPL after test: $\pm 10\text{dB}$ .
3	Humidity Test	After being Placed in a chamber with 90-95% R.H. at $40\pm 2^{\circ}\text{C}$ for 96 hours and then being placed in normal condition for 2 hours. Allowable variation of SPL after test: $\pm 10\text{dB}$ .
4	Temperature Cycle Test	<p>The part shall be subjected to 5 cycles. One cycle shall be consist of:</p>  <p>Allowable variation of SPL after test: <math>\pm 10\text{dB}</math>.</p>
5	Drop Test	Drop on a hard wood board of 4cm thick, any directions ,6 times, at the height of 100cm. Allowable variation of SPL after test: $\pm 10\text{dB}$ .
6	Vibration Test	After being applied vibration of amplitude of 1.5mm with 10 to 55 Hz band of vibration frequency to each of 3 perpendicular directions for 2 hours . Allowable variation of SPL after test: $\pm 10\text{dB}$ .
7	Solder ability Test	Lead terminals are immersed in rosin for 5 seconds and then immersed in solder bath of $+300\pm 5^{\circ}\text{C}$ for $3\pm 1$ seconds.90% min. lead terminals shall be wet with solder (Except the edge of terminals).
8	Terminal / Wire Strength Pulling Test	The force of 9.8N(1.0kg) is applied to each terminal in axial direction for 10 seconds. No visible damage and cutting off.

## 7.Reliability Test

### Continuous life test:

250 Hours continuous operating at  $+70^{\circ}\text{C}$  with maximum rated voltage applied .

### Intermittent life test:

Aduty cycle of 1 minute on, 5 minutes off,a minimum of 10000 times at temperature  $+25^{\circ}\text{C}\pm 2$

## 8.Dimension

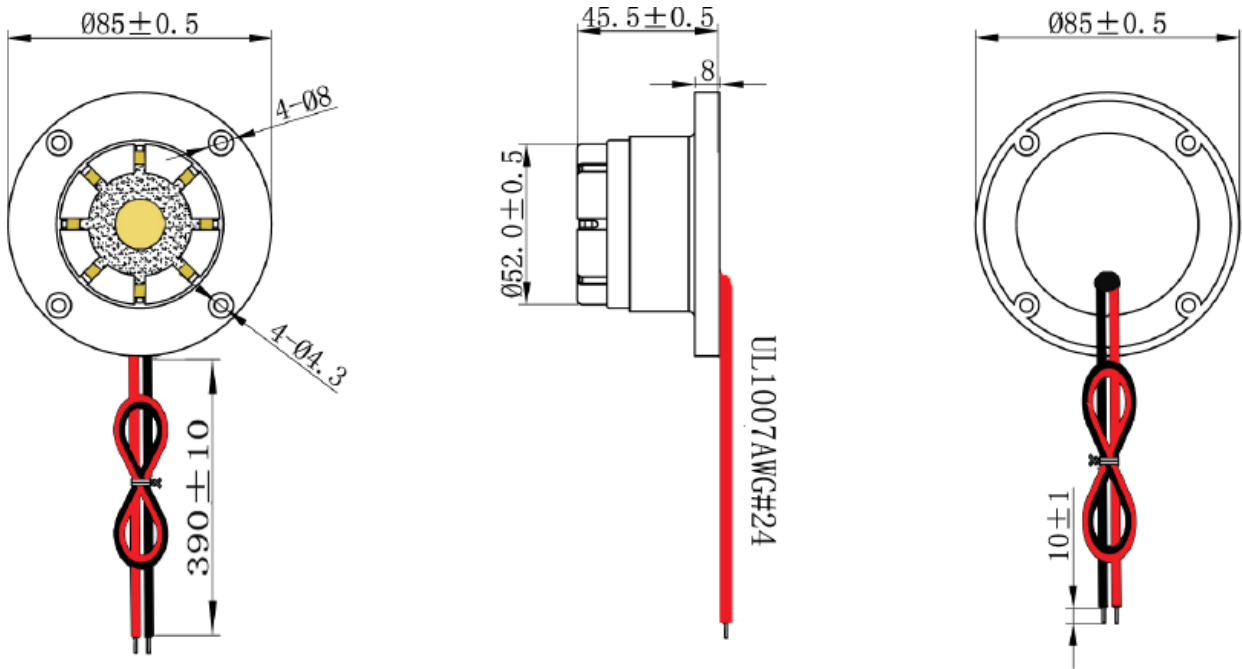

Tolerance  $\pm 0.5\text{mm}$

## 9.Packing List

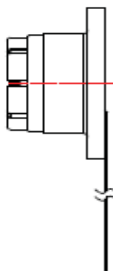

HPE-100P

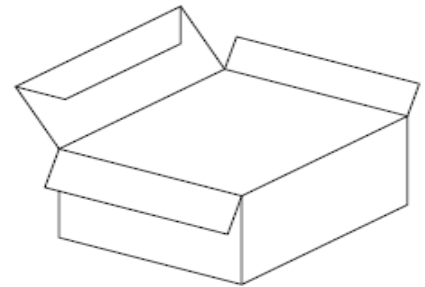

In Package: 9\*9\*5cm

Carton: 200PCS  
Carton: 46\*46\*42cm

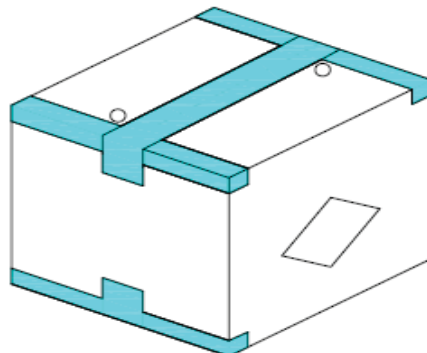

P/N: HPE-100P  
QTY: 200 PCS  
N. W: 20 KGS  
G. W: 21 KGS  
CTN: 46\*46\*42cm