

ZENDER ASSEMBLY(APPLE)

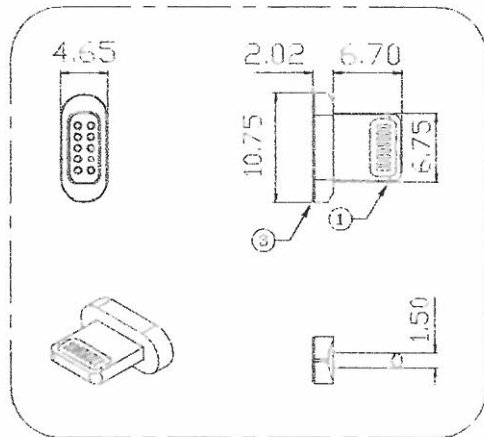
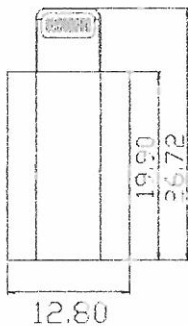
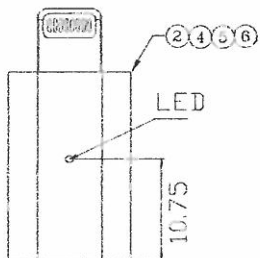
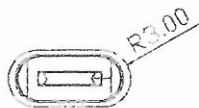

NO	DESCRIPTION	SPECIFICATION	U'T	Q'TY
1	APPLE EP PLUG	APPLE EPIN+ MARGNET	EA	1
2	APPLE POGO PIN	POGO PIN+PCB ASSY+ZENDER SOCKLT	EA	1
3	APPLE HOLDER	ABS WHT	EA	1
4	APPLE MARGNETIC	MARGNET	EA	1
5	APPLE CASE	APPLE CASE, AL, BLK	EA	1
6	BOND	401	KG	0.0002
7	IN BOX TRAY	APPLE-ZENDER(S116-08-285)	EA	1
8	IN BOX	APPLE-ZENDER(S116-08-285)	EA	1
9	OUT BOX	510*280*320	EA	1

DATE	DESIGNER	CHECKER	APPROVER	NAME	ZENDER ASSEMBLY (APPLE)	SCALE	1/1
11-11-11	王	王	王	崔	SJ16-08-285	REV.	-
11-11-11	王	王	王	崔		SIZES	A4
11-11-11	王	王	王	崔		SHEET	1/1

HOLDER(APPLE)

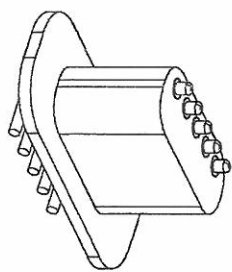
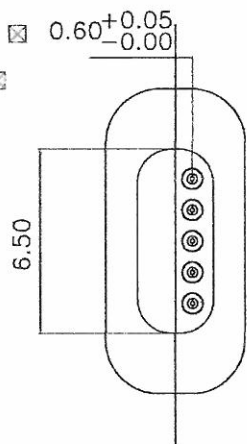
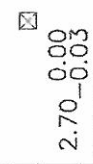
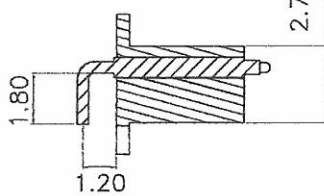
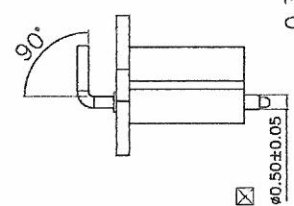
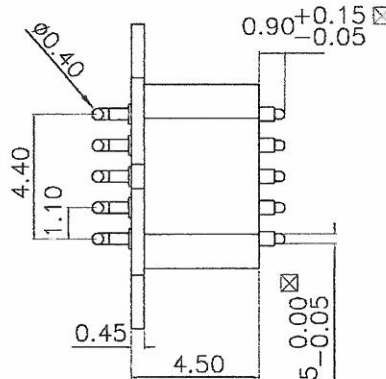
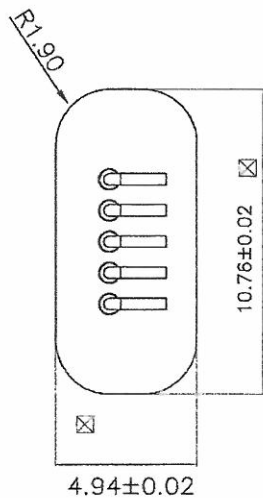

DATE	DESIGNED	CHECKED	APPROVED	NAME	POSITION	SCALE	1/1
2016-11-17	崔	崔	崔	HWG NO.	SJ16-08-005	REV.	-
				DBE	-	SJ16	P4
				QUEL	-	CHECK NO.	1/1