

Manual

# SD-34 | SD-34.2

Item no. 44-01345 | 44-01346 | 44-01347

Item no. 44-01356 | 44-02357

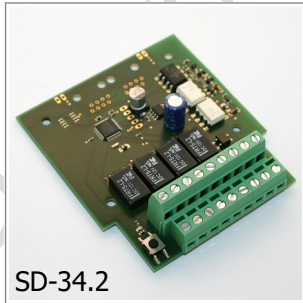
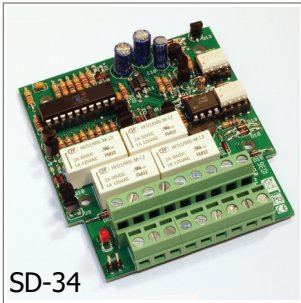

4-fold Switching Decoder

MM

DCC

RailCom

tams elektronik



## Table of contents

1. Getting started.....	3
2. Safety instructions.....	5
3. Safe and correct soldering.....	7
4. Operation overview.....	9
5. Technical specifications.....	11
6. Assembling the kit (SD-34).....	12
7. Connecting the decoder.....	20
8. Programming the decoder.....	23
9. Check list for troubleshooting.....	27
10. Guarantee bond.....	29
11. EU declaration of conformity.....	30
12. Declarations conforming to the WEEE directive.....	30

© 09/2016 Tams Elektronik GmbH

All rights reserved. No part of this publication may be reproduced or transmitted in any form or by any means, electronic or mechanical, including photocopying, without prior permission in writing from Tams Elektronik GmbH.

Subject to technical modification.

**Remark:** RailCom<sup>®</sup> is the registered trademark of the Lenz Elektronik GmbH, Hüttenbergstraße 29, D-35398 Gießen. To increase the text's readability we have refrained from referring to this point in each instance.

## 1. Getting started

### How to use this manual

This manual gives step-by-step instructions for safe and correct assembly of the kit and fitting and connecting of the ready-built module, and operation. Before you start, we advise you to read the whole manual, particularly the chapter on safety instructions and the checklist for trouble shooting. You will then know where to take care and how to prevent mistakes which take a lot of effort to correct.

Keep this manual safely so that you can solve problems in the future. If you pass the kit or the ready-built module on to another person, please pass on the manual with it.

### Intended use

The switching decoders SD-34 and SD-34.2 are designed to be operated according to the instructions in this manual in digital model railway layouts. Any other use is inappropriate and invalidates any guarantees.

The switching decoders should not be assembled or mounted by children under the age of 14.

Reading, understanding and following the instructions in this manual are mandatory for the user.



#### **Caution:**

The switching decoders SD-34 and SD-34.2 contain integrated circuits. These are very sensitive to static electricity. Do not touch components without first discharging yourself. Touching a radiator or other grounded metal part will discharge you.

## Checking the package contents

Please make sure that your package contains:

- one kit SD-34, containing the components listed in the parts list and one PCB or
- one ready-built module SD-34 or SD-34.2 or
- one ready-built module SD-34 or SD-34.2 in a housing (complete unit)
- SD-34 only: one jumper for programming the address
- a CD (containing the manual and further information)

## Required materials

For assembling the kit you need:

- an electronic soldering iron (max. 30 Watt) or a regulated soldering iron with a fine tip and a soldering iron stand,
- a tip-cleaning sponge,
- a heat-resistant mat,
- a small side cutter and wire stripper,
- as necessary a pair of tweezers and long nose pliers,
- electronic tin solder (0,5 mm. diameter).

In order to connect the module you need wire. Recommended diameters:  $\geq 0,25 \text{ mm}^2$  for all connections.

## 2. Safety instructions

### **Mechanical hazards**

Cut wires can have sharp ends and can cause serious injuries. Watch out for sharp edges when you pick up the PCB.

Visibly damaged parts can cause unpredictable danger. Do not use damaged parts: recycle and replace them with new ones.

### **Electrical hazards**

- Touching powered, live components,
- touching conducting components which are live due to malfunction,
- short circuits and connecting the circuit to another voltage than specified,
- impermissibly high humidity and condensation build up

can cause serious injury due to electrical shock. Take the following precautions to prevent this danger:

- Never perform wiring on a powered module.
- Assembling and mounting the kit should only be done in closed, clean, dry rooms. Beware of humidity.
- Only use low power for this module as described in this manual and only use certified transformers.
- Connect transformers and soldering irons only in approved mains sockets installed by an authorised electrician.
- Observe cable diameter requirements.
- After condensation build up, allow a minimum of 2 hours for dispersion.
- Use only original spare parts if you have to repair the kit or the ready-built module.

## Fire risk

Touching flammable material with a hot soldering iron can cause fire, which can result in injury or death through burns or suffocation. Connect your soldering iron or soldering station only when actually needed. Always keep the soldering iron away from inflammable materials. Use a suitable soldering iron stand. Never leave a hot soldering iron or station unattended.

## Thermal danger

A hot soldering iron or liquid solder accidentally touching your skin can cause skin burns. As a precaution:

- use a heat-resistant mat during soldering,
- always put the hot soldering iron in the soldering iron stand,
- point the soldering iron tip carefully when soldering, and
- remove liquid solder with a thick wet rag or wet sponge from the soldering tip.

## Dangerous environments

A working area that is too small or cramped is unsuitable and can cause accidents, fires and injury. Prevent this by working in a clean, dry room with enough freedom of movement.

## Other dangers

Children can cause any of the accidents mentioned above because they are inattentive and not responsible enough. Children under the age of 14 should not be allowed to work with this kit or the ready-built module.



### Caution:

Little children can swallow small components with sharp edges, with fatal results! Do not allow components to reach small children.

In schools, training centres, clubs and workshops, assembly must be supervised by qualified personnel.

In industrial institutions, health and safety regulations applying to electronic work must be adhered to.

### 3. Safe and correct soldering



#### **Caution:**

Incorrect soldering can cause dangers through fires and heat. Avoid these dangers by reading and following the directions given in the chapter **Safety instructions**.

- Use a small soldering iron with max. 30 Watt or a regulated soldering iron.
- Only use electronic tin solder with flux.
- When soldering electronic circuits never use soldering-water or soldering grease. They contain acids that can corrode components and copper tracks.
- Insert the component connecting pins of into the PCB's holes as far as possible without force. The components should be close to the PCB's surface.
- Observe correct polarity orientation of the parts before soldering.
- Solder quickly: holding the iron on the joints longer than necessary can destroy components and can damage copper tracks or soldering eyes.
- Apply the soldering tip to the soldering spot in such a way that the part and the soldering eye are heated at the same time. Simultaneously add solder (not too much). As soon as the solder becomes liquid take it away. Hold the soldering tip at the spot for a few seconds so that the solder flows into the joint, then remove the soldering iron.
- Do not move the component for about 5 seconds after soldering.

- To make a good soldering joint you must use a clean and unoxidised soldering tip. Clean the soldering tip with a damp piece of cloth, a damp sponge or a piece of silicon cloth.
- Cut the wires after soldering directly above the soldering joint with a side cutter.
- After placing the parts, please double check for correct polarity. Check the PCB tracks for solder bridges and short circuits created by accident. This would cause faulty operation or, in the worst case, damage. You can remove excess solder by putting a clean soldering tip on the spot. The solder will become liquid again and flow from the soldering spot to the soldering tip.



## 4. Operation overview

The switching decoders SD-34 and SD-34.2 are designed to control accessories, switched on and off or changed over via a change-over relay, e.g.

- lightings,
- light signals,
- motor-run points with tape shut-off.

With one switching decoder you can control a maximum of four accessories independent of each other.

### **Driving the decoder via accessory decoder commands**

The outputs of the decoders SD-34 and SD-34.2 are operated via accessory decoder commands in DCC or Motorola format, sent from the central unit to one of the four accessory decoder's addresses. The decoders automatically recognize the commands' data format. It is possible to switch the outputs via mixed DCC and Motorola commands as well as to operate one output alternately in DCC and Motorola format.

### **Operation via vehicle decoder commands ( SD-34.2 only)**

You can use a vehicle decoder address (locomotive address) to operate the switching decoder SD-34.2 instead of an accessory decoder address (points address). The 4 outputs of the decoder are switched via the function keys F1 to F4 then. This allows to use the SD-34.2 in combination with DCC control units not designed for controlling points addresses.

## **Programming**

Using a DCC central unit the decoder address and the decoder's features can be defined by programming the configuration variables (CV). It is also possible to set the address by using a programming jumper (SD-34) or a push-button switch (SD-34.2).

When using a Motorola central unit the (accessory) decoder address has to be set with a programming jumper (SD-34) or a push-button switch (SD-34.2). Changing the other decoder's features or assigning a locomotive address is neither necessary nor possible in layouts run in Motorola format only.

## **Feedback via RailCom**

The switching decoders SD-34 and SD-34.2 are RailCom compatible, i.e. the decoders are able to pass the RailCom messages via the rails to special RailCom detectors. This allows e.g. to feedback the correct performance of setting and switching commands.

## **Power supply**

The switching decoders SD-34 and SD-34.2 can either be supplied by the central unit or a booster. In order to release the digital electric circuit it is also possible to supply the decoders by a transformer of their own instead.

## 5. Technical specifications

Data format	DCC, Motorola
<b>Address range</b> Hint: The address range to be used also depends from the control unit.	SD-34: MM: 1020 points addresses DCC: 2040 points addresses SD-34.2: MM: 1020 points addresses DCC: 2040 points addresses or 510 locomotive addresses
Feedback log	RailCom
Supply voltage	Digital voltage of the central unit or 14 – 20 V a.c. voltage
Current consumption (without connected devices) approx.	SD-34: 40 mA SD-34.2: 60 mA
Number of change-over switches	4
Max. current per change-over switches	1.000 mA
Protected to	IP 00
Ambient temperature in use	0 ... +60 °C
Ambient temperature in storage	-10 ... +80 °C
Comparative humidity allowed	max. 85 %
Dimensions of the PCB Dimensions including housing	approx. 72 x 82 mm approx. 100 x 90 x 35 mm
Weight of the assembled board Weight including housing	approx. 67 g approx. 115 g

## 6. Assembling the kit (SD-34)

You can skip this part if you have purchased a ready-built module or device.

### Preparation

Put the sorted components in front of you on your workbench.

The separate electronic components have the following special features you should take into account in assembling:

### Resistors

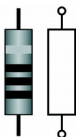

Resistors reduce current.

The value of resistors for smaller power ratings is indicated through colour rings. Every colour stands for another figure. Carbon film resistors have 4 colour rings. The 4th ring (given in brackets here) indicates the tolerance of the resistor (gold = 5 %, silver = 10 %).

Value:	Colour rings:
33 $\Omega$	orange – orange – black (gold)
100 $\Omega$	brown - black - brown (gold)
220 $\Omega$	red - red - brown (gold)
1 k $\Omega$	brown - black - red (gold)
2,2 k $\Omega$	red - red - red (gold)
1,5 k $\Omega$	brown - green - red (gold)
4,7 k $\Omega$	yellow - violet - red (gold)
10 k $\Omega$	brown - black - orange (gold)

## Ceramic capacitors



Among other things ceramic capacitors are used for filtering interference voltages or as frequency determining parts. Ceramic capacitors are not polarized.

Normally they are marked with a three-digit number which indicates the value coded. The number 104 corresponds to the value 100 nF.

## Electrolytic capacitors

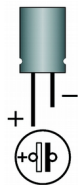

Electrolytic capacitors are often used to store energy. In contrast to ceramic capacitors they are polarized. The value is given on the casing.

Electrolytic capacitors are available with different voltage sustaining capabilities. Using an electrolytic capacitor with a voltage sustaining capability higher than required is always possible.

## Diodes and Zener diodes

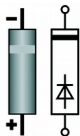

Diodes allow the current to pass through in one direction only (forward direction), simultaneously the voltage is reduced by 0,3 to 0,8 V. Exceeding of the limit voltage always will destroy the diode, and allow current to flow in the reverse direction.

Zener diodes are used for limiting voltages. In contrast to "normal" diodes they are not destroyed when the limit voltage is exceeded.

The diode type is printed on the body.

## Light emitting diodes (LEDs)

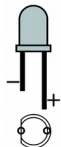

When operated in the forward direction the LEDs light. They are available in several different versions (differing in colour, size, form, luminosity, maximum current, voltage limits).

Light emitting diodes should always be connected via a series resistor which limits the current and prevents failure.

## Transistors

Transistors are current amplifiers which convert low signals into stronger ones. There are several types in different package forms available. The type designation is printed on the component.

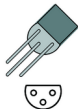

Transistors for a low power rating (e.g. BC types) have a package in form of a half cylinder (SOT-Gehäuse).

The three pins of bipolar transistors (e.g. BC types) are called basis, emitter and collector (abbreviated with the letters B, E, C in the circuit diagram).

## Integrated circuits (ICs)

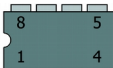

Depending on the type, ICs fulfil various tasks. The most common housing form is the so-called "DIL"-housing, from which 4, 6, 8, 14, 16, 18 or more "legs" (pins) are arranged along the long sides.

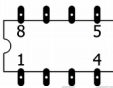

ICs are sensitive to damage during soldering (heat, electrostatic charging). For that reason in the place of the ICs IC sockets are soldered in, in which the ICs are inserted later.

## Microcontrollers

Microcontrollers are ICs, which are individually programmed for the particular application. The programmed controller are only available from the manufacturer of the circuit belonging to it.

## **Opto couplers**

Opto couplers are ICs, which work similar to laser beam switches. They combine in one housing a light emitting diode and a photo transistor. Their task is the transmission of information without galvanic connection. They are in a DIL-housing with at least 4 pins.

## **Relays**

Relays are electronic switches, depending on their position the one or other (internal) connection is closed. The mode of operation of monostable relays can be compared to that of a push-button switch, i.e. the connection is only closed as long as the voltage is applied. Bistable relays keep their status after switching – comparable to a switch.

Relays which combine two switches in one housing are common as well (shortly 2xUM). The switching between the two connections can be heard clearly because of the resulting clicking sound.

## **Terminal strips**

Terminal strips are solder-in screw-type terminals. They provide a solder-free and safe connection of the cables to the circuit, which can still be separated any time.

**Parts list (SD-34)**

Carbon film resistors	R4, R20	33 $\Omega$
	R18, R27, R28	100 $\Omega$
	R23, R25	220 $\Omega$
	R19, R22	1 k $\Omega$
	R8, R9, R10, R11, R12, R13, R14, R15, R17	1,5 k $\Omega$
	R1, R3, R7, R21	2,2 k $\Omega$
	R24	4,7 k $\Omega$
	R2, R16	10 k $\Omega$
Ceramic capacitors	C1, C4, C39	100 nF
Electrolytic capacitors	C10	100 $\mu$ F/25V
	C2, C3	220 $\mu$ F/25V
Diodes	D9, D10, D11	1N400x, x=2...7
	D1, D2, D3, D4, D5, D6, D7, D8, D15, D16, D17, D18, D19, D21, D22, D23, D24	1N4148
Zener diodes	D12, D20	ZPD5V1
	D14	ZPD47V
LEDs	LED1	LED 3mm
Transistors for a low power rating	Q2	BC327
	Q3	BC337
	Q4, Q5, Q13	BC 516
	Q1, Q6, Q7, Q8, Q9, Q10, Q11, Q12	BC557B
Microcontrollers	IC1	PIC16F690P



Opto couplers	OK1, OK4	6N136
	OK2, OK3	PC817 (2 pieces) or PC827 (1 piece)
IC-sockets	IC1	20-pole
	OK1, OK4, OK2/OK3	8-pole
Relays	K1, K2, K3, K4	bistable 2 x Um 5 V
Double terminal strips	X4	2 x 9-pole
Solder pins	JP1	2-pole

**Fig.1 : PCB layout (SD-34)**

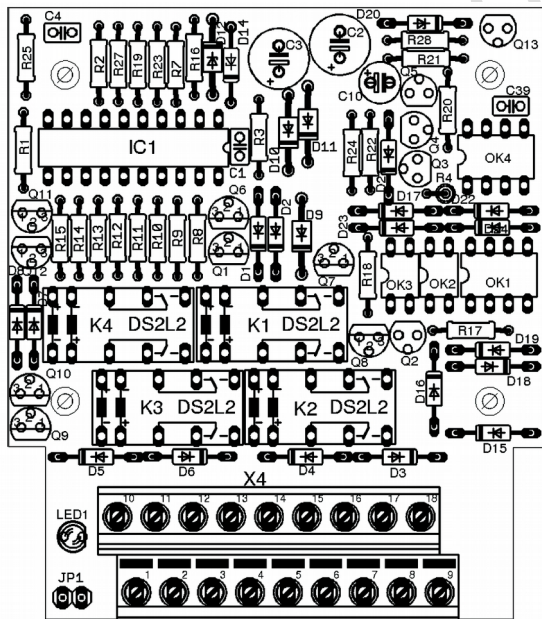

## Assembly

Proceed according to the order given in the list below. First solder the components on the solder side of the PCB and then cut the excess wires with the side cutter. Follow the instructions on soldering in section 3.

**! Caution:** Several components have to be mounted according to their polarity. When soldering these components the wrong way round, they can be damaged when you connect the power. In the worst case the whole circuit can be damaged. At the best, a wrongly connected part will not function.

1.	Resistors (except R4)	Mounting orientation of no importance.
2.	Diodes, Zener diodes	Observe the polarity! The negative end of the diodes is marked with a ring. This is shown in the PCB layout.
3.	Ceramic Capacitors	Mounting orientation of no importance.
4.	IC sockets	Mount the sockets that way, the marking on the sockets show in the same direction as the markings on the PCB board.
5.	Light emitting diodes (LEDs)	Observe the polarity! With wired LEDs the longer lead is always the anode (positive pole).
6.	Transistors	Observe the polarity! The cross section of transistors for a low power rating in SOT-packages is shown in the PCB layout.
7.	Solder pins	

8.	Resistor R4	Solder the resistor that way, it's body is standing upright on the PCB.
9.	Relays	The mounting orientation is given by the layout of the pins.
10.	Electrolytic capacitors	Observe the polarity! One of the two leads (the shorter one) is marked with a minus sign.
11.	Terminal strips	Put together the terminal strips before mounting them.
12.	ICs in DIL-housing	Insert the ICs into the soldered socket. Do not touch the ICs without first discharging yourself by touching a radiator or other grounded metal parts. Do not bend the "legs" when inserting them into the sockets. Check that the markings on the PCB, the socket and the IC show to the same direction.

### Performing a visual check

Perform a visual check after the assembly of the module and remove faults if necessary:

- Remove all loose parts, wire ends or drops of solder from the PCB. Remove all sharp wire ends.
- Check that solder contacts which are close to each other are not unintentionally connected to each other. Risk of short circuit!
- Check that all components are polarised correctly.

When you have remedied all faults, go on to the next part.

## 7. Connecting the decoder

The decoder has terminal strips inserted to plug in and screw on the connecting wires. Make the connections one after the other:

- to the accessories
- the central unit
- the power supply

### Power supply

You can supply the decoder either via the central unit or via a separate transformer according to the two following diagrams.

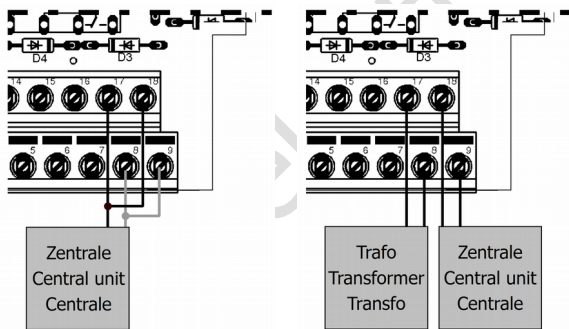

Fig. 2: Power supply via central unit Fig. 3: Power supply via separate transformer



**Caution:** Switch off the central unit before connecting the decoder.



**Caution:** If a component gets too hot, disconnect the decoder and the power supply from the mains **immediately**. Possible short circuit! Check the assembly!

## Pin connections accessory decoder SD-34

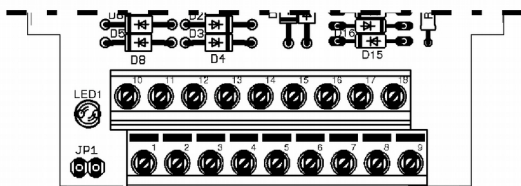

Connection	Switching decoder SD-34
JP1	Programming jumper
1	Switching contact 2, to be switched with "straight on"
2	Switching contact 2, return conductor
3	Switching contact 2, to be switched with "branching"
4	Switching contact 4, to be switched with "straight on"
5	Switching contact 4, return conductor
6	Switching contact 4, to be switched with "branching"
7	not in use
8	Power supply / transformer (~)
9	Input DCC signal / central unit
10	Switching contact 1, to be switched with "straight on"
11	Switching contact 1, return conductor
12	Switching contact 1, to be switched with "branching"
13	Switching contact 3, to be switched with "straight on"
14	Switching contact 3, return conductor
15	Switching contact 3, to be switched with "branching"
16	not in use
17	Power supply / transformer (~)
18	Input DCC signal / central unit

## Pin connections accessory decoder SD-34.2

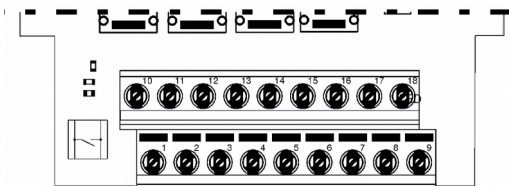

Switching decoder SD-34.2	
JP1	Programming jumper
1	Switching contact 2, to be switched with "branching" or F2 = "on"
2	Switching contact 2, return conductor
3	Switching contact 2, to be switched with "straight on" of F2 = "off"
4	Switching contact 4, to be switched with "branching" or F4 = "on"
5	Switching contact 4, return conductor
6	Switching contact 4, to be switched with "straight on" of F4 = "off"
7	not in use
8	Power supply / transformer (~)
9	Input DCC signal / central unit
10	Switching contact 1, to be switched with "branching" or F1 = "on"
11	Switching contact 1, return conductor
12	Switching contact 1, to be switched with "straight on" of F1 = "off"
13	Switching contact 3, to be switched with "branching" or F3 = "on"
14	Switching contact 3, return conductor
15	Switching contact 3, to be switched with "straight on" of F3 = "off"
16	not in use
17	Power supply / transformer (~)
18	Input DCC signal / central unit

## 8. Programming the decoder

You can program the configuration variables (CV) using a DCC digital central unit. See the chapter in the manual of your central unit where the byte wise programming of configuration variables (CVs) is explained.

When using a Motorola central unit you can set the decoder address with a programming jumper (SD-34) or with a programming push-button (SD-34.2). Changing the other decoder's features or assigning a locomotive address is neither necessary in layouts run in Motorola format only nor possible with Motorola central units.

### **Programming decoder and accessory decoder addresses**

You can set the decoder address either by programming the CVs with your DCC central unit or by using the programming jumper or push-button. When setting the decoder address it is of no importance if you intend to operate the decoder by vehicle decoder commands (locomotive commands) or accessory decoder commands (points commands).

The accessory decoder address used to send the switching commands result from:

Decoder address x 4

= highest address of the quadruple accessory decoder address block

When operating the decoder by locomotive addresses, you use the function keys F1 to F4 to switch the connected accessories.

Name of CVs	CV-no.	Input value (Default)	Remarks and tips
Decoder address 1 to 63	1	1, 2, 3, ... 63 (1)	NB: In addition, you have to input the value "0" in CV#9.
Decoder address (64 to 510)	9	0, 1, 2, 3 ... 7 (0)	Please notice: You have to input a value in CV#1 as well.
Determining the input values for addresses higher than 64:			Example: address 415:
1. Divide the chosen address by 64. Round down the result to a whole number. Input this value in CV#9.			1. $415 / 64 = 6,5 \rightarrow \text{CV}\#9 = 6$
2. Multiply the value set for CV#9 multiply by 64. Subtract this result from the chosen address. Enter this value in CV#1.			2. $415 - (6 \times 64) = 31 \rightarrow \text{CV}\#1 = 31$

## Setting the address with the programming jumper or push-button

SD-34:  
Solder pin for plugging on the programming jumper

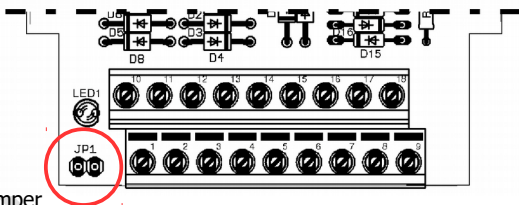

SD-34.2:  
Programming push-button

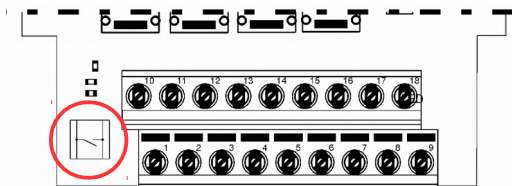



With Motorola central units the address can be set via the programming jumper (SD-34) or the programming push-button (SD-34.2) only. When using DCC central units it is often easier to set the address via the programming jumper / push-button than to program it via CV.

Hint: Setting the address via the jumper / push-button is impossible unless the decoder is operated by points addresses. When the operation via locomotive addresses is set in CV#29, it is impossible to set the address with the jumper/push-button.

In order to set the address via the programming jumper / push-button perform the following steps:

1. SD-34: Bridge the two pins of the programming connector JP1, by putting on the jumper included in the package. Take it away as soon as the LED flashes.

SD-34.2: Push the programming push-button on the PCB. The LED flashes.

2. Set one of the addresses from the quadruple accessory decoder address block you want to use for switching the connected accessories at the control unit (e.g. address "10" from the quadruple accessory decoder address block 9 – 12). Perform a switching command for the chosen address.
3. As soon as the LED goes out, the decoder has taken over the new address.

### Programming the basic features

Name of CVs	CV-no.	Input value (Default)	Remarks and tips
Version	7	---	Read only!
Manufacturer	8	(62)	Read only!
Reset	8	0 ... 255	Any input value restores the settings in state of delivery.

### Programming the configuration data for the SD-34

Name of CVs	CV-no.	Input value (Default)	Remarks and tips
Configuration data 1 → <b>SD-34</b>	29	128, 136 (136)	RailCom off           128 RailCom on           136
Configuration data 1 → <b>SD-34.2</b>	29	0, 8, 128, 136 (136)	RailCom off           0 RailCom on           8  Operation via points addresses    0 locomotive addresses 128

Advice: When RailCom is not used it is recommended to switch it off in CV#29.

Configuration data 2	33	0, 1 (0)	RailCom check on    0 RailCom check off   1
----------------------	----	-------------	------------------------------------------------

In standard operation the decoder checks directly after having been switched on if the booster for the connected section supplies a RailCom cutout. In case faulty detections are mounting the RailCom check should be switched off. This has no effect on the feedback with RailCom.

## 9. Check list for troubleshooting

- Parts are getting too hot and/or start to smoke.



Disconnect the system from the mains immediately!

Possible cause: one or more components are soldered incorrectly.  
→ In case you have mounted the module from a kit, perform a visual check (→ section 6.) and if necessary, remedy the faults. Otherwise send in the module for repair.

- The decoder does not work.

Possible cause: The connection of the decoder to the central unit and / or the power supply is interrupted. → Check the connections.

Possible cause: The connection of the decoder to the accessory or the points is interrupted. → Check the connections.

Possible cause: The central unit is not operating. → Check if the central unit is ready for operation.

Possible cause: The connected accessory or the connected points is defective. → Check the accessory or the points.

- After programming the address the decoder does not react to switching commands.

Possible cause: When programming the decoder address via CV you set the decoder address. To switch the decoder accessory decoder addresses are used. → Input the accessory decoder address to switch. (Advice: The decoder address multiplied with 4 tallies to the highest address from the quadruple accessory decoder address block. Example: decoder address = 10 → corresponding accessory decoder addresses: 37 to 40.)

**Hotline:** If problems with your module occur, our hotline is pleased to help you (mail address on the last page).

**Repairs:** You can send in a defective module for repair (address on the last page). In case of guarantee the repair is free of charge for you. With damages not covered by guarantee, the maximum fee for the repair is the difference between the price for the ready-built module and the kit according to our valid price list. We reserve the right to reject the repairing of a module when the repair is impossible for technical or economic reasons.

Please do not send in modules for repair charged to us. In case of warranty we will reimburse the forwarding expenses up to the flat rate we charge according to our valid price list for the delivery of the product. With repairs not covered by guarantee you have to bear the expenses for sending back and forth.

## 10. Guarantee bond

For this product we issue voluntarily a guarantee of 2 years from the date of purchase by the first customer, but in maximum 3 years after the end of series production. The first customer is the consumer first purchasing the product from us, a dealer or another natural or juristic person reselling or mounting the product on the basis of self-employment. The guarantee exists supplementary to the legal warranty of merchantability due to the consumer by the seller.

The warranty includes the free correction of faults which can be proved to be due to material failure or factory flaw. With kits we guarantee the completeness and quality of the components as well as the function of the parts according to the parameters in not mounted state. We guarantee the adherence to the technical specifications when the kit has been assembled and the ready-built circuit connected according to the manual and when start and mode of operation follow the instructions.

We retain the right to repair, make improvements, to deliver spares or to return the purchase price. Other claims are excluded. Claims for secondary damages or product liability consist only according to legal requirements.

Condition for this guarantee to be valid, is the adherence to the manual. In addition, the guarantee claim is excluded in the following cases:

- if arbitrary changes in the circuit are made,
- if repair attempts have failed with a ready-built module or device,
- if damaged by other persons,
- if damaged by faulty operation or by careless use or abuse.

## 11. EU declaration of conformity

 This product conforms with the EC-directives mentioned below and is therefore CE certified.

2004/108/EG on electromagnetic. Underlying standards: EN 55014-1 and EN 61000-6-3. To guarantee the electromagnetic tolerance in operation you must take the following precautions:

- Connect the transformer only to an approved mains socket installed by an authorised electrician.
- Make no changes to the original parts and accurately follow the instructions, connection diagrams and PCB layout included with this manual.
- Use only original spare parts for repairs.

2011/65/EG on the restriction of the use of certain hazardous substances in electrical and electronic equipment (ROHS). Underlying standard: EN 50581.

## 12. Declarations conforming to the WEEE directive



This product conforms with the EC-directive 2012/19/EG on waste electrical and electronic equipment (WEEE).

Don't dispose of this product in the house refuse, bring it to the next recycling bay.

tams elektronik

Information and tips:

<http://www.tams-online.de>

Warranty and service:

Tams Elektronik GmbH

Fuhrberger Straße 4

DE-30625 Hannover

fon: +49 (0)511 / 55 60 60

fax: +49 (0)511 / 55 61 61

e-mail: [modellbahn@tams-online.de](mailto:modellbahn@tams-online.de)

