

■ Features

- Compact microminiature general purpose automotive relay
Dimensions: 15.6×12.2×13.7(mm)
 - High inrush capability: 60A
 - Contains no lead and features cadmium-free contacts ensuring environment-friendly use
- Applications: car alarm, power window, central locking system, seat adjustment control, etc



ORDERING INFORMATION

CMA51 [H] - [S] - [DC12V] - [A]

Model	Coil Sensitivity	Enclosure	Coil Voltage	Contact Form
	H - High Sensitivity (600mW) Blank-Standard (800mW)	S - Plastic Sealed Type	DC6V, DC9V, DC10V, DC12V, DC24V	A - 1 Form A B - 1 Form B C - 1 Form C

SPECIFICATION

CONTACT DATA

Contact Form	1 Form A, 1 Form B, 1 Form C	
Contact Material	Ag Alloy	
Contact Rating	A: 20A 14VDC Resistive B, C: 15A 14VDC Resistive	
Contact Resistance	Max. 50mΩ (6VDC 1A)	
Load	Max. Switching Voltage	30VDC
	Max. Continuous Current	35A/10min.25A/1 Hr
	Max. Switching Current	35A
	Max. Inrush Current	60A
Life	Electrical	100,000 operations
	Mechanical	10,000,000 operations

COIL DATA

Nominal Coil Power	600mW, 800mW
--------------------	--------------

GENERAL DATA

Insulation Resistance	Min. 100MΩ 500VDC	
Dielectric Strength	Between open contacts	500VAC, 1min
	Between coil and contacts	500VAC, 1min
Operate Time	Max. 10ms	
Release Time	Max. 10ms	
Operating Temperature	-40℃ to +85℃	
Humidity	35~95%RH, +40℃	
Shock Resistance	Endurance	1,000m/s ²
	Misoperation	100m/s ²
Vibration Resistance	Endurance	10~55Hz, 1.5mm double amplitude
	Misoperation	10~55Hz, 1.5mm double amplitude
Weight	Approximately 6.0g	

Note: Data shown are of initial value

COIL DATA

Ambient Temperature: 23°C

Model	Nominal Voltage VDC	Coil Resistance $\Omega \pm 10\%$	Operate Voltage \leq VDC	Release Voltage \geq VDC	Coil Power mW
CMA51H-S-DC6V	6	60	3.6	0.6	600
CMA51H-S-DC9V	9	135	5.4	0.9	
CMA51H-S-DC10V	10	167	6.0	1.0	
CMA51H-S-DC12V	12	240	7.2	1.2	
CMA51H-S-DC24V	24	960	14.4	2.4	
CMA51-S-DC6V	6	45	3.6	0.6	800
CMA51-S-DC9V	9	100	5.4	0.9	
CMA51-S-DC10V	10	125	6.0	1.0	
CMA51-S-DC12V	12	180	7.2	1.2	
CMA51-S-DC24V	24	720	14.4	2.4	

OUTLINE, WIRING DIAGRAM, MOUNTING HOLE LAYOUT (UNIT: mm)

1 Form C

Outline

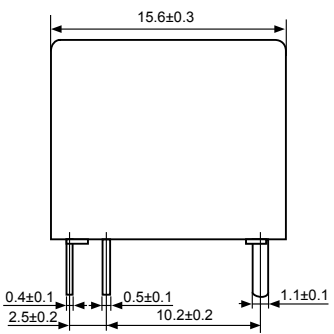

Mounting Hole Layout (Bottom View)

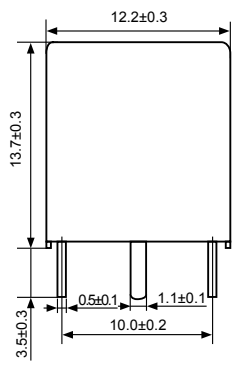

Wiring Diagram (Bottom View)

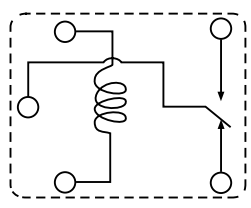
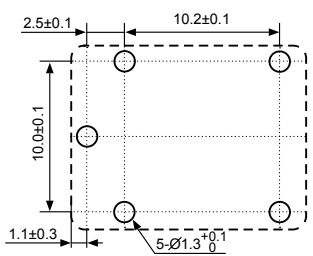

OUTLINE, WIRING DIAGRAM, MOUNTING HOLE LAYOUT (UNIT: mm)

1 Form A

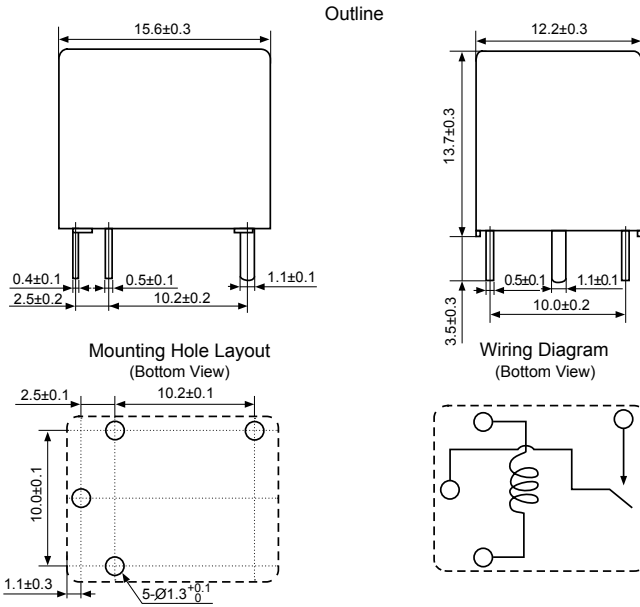

1 Form B

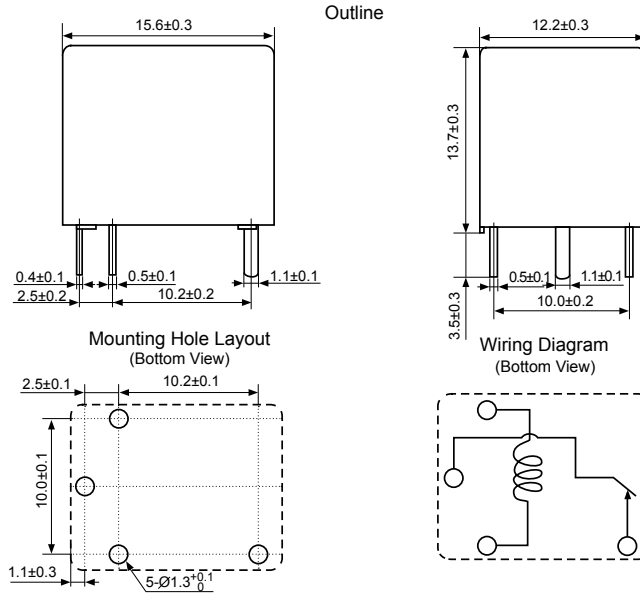

REFERENCE DATA

Maximum Switching Power

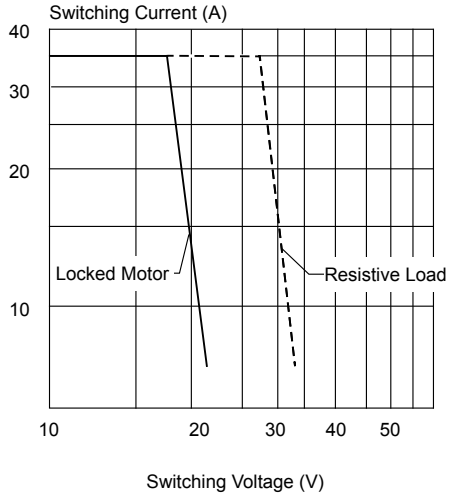

Coil Temperature Rise (Ambient Temperature: 23°C)

