

FEATURES

- 0603, 0805, 0806 AND 1008 CASE SIZES
- HIGH DC CURRENT AND LOW DC RESISTANCE
- NEW "S" VERSION FOR INCREASED SATURATION CURRENT
- UPGRADED "H" VERSION FOR HIGHEST CURRENT
- REFLOW SOLDERING APPLICABLE
- PACKAGE FOR AUTOMATIC PICK-PLACE

RoHS Compliant

Includes all homogeneous materials

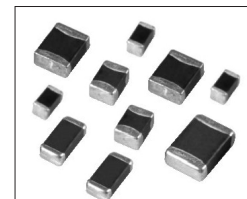

SPECIFICATIONS

Specifications	Case Size			
	0603	0805	0806	1008
Inductance Range	0.47 μ H ~ 2.2 μ H	0.22 μ H ~ 10 μ H	0.47 μ H ~ 10 μ H	0.47 μ H ~ 10 μ H
Inductance Tolerance	\pm 20% (M), \pm 30% (N)			
Operating Temperature Range	-40°C ~ +85°C			
Self Resonant Frequency, DC Resistance, Rated DC Current and Inductance Tolerance	See Standard Values and Specifications Table			

Note: Extended values, tolerances, and enhanced versions are available please contact NIC for more details.

DIMENSIONS (mm)

Case Size	L	W	H	P
0603	1.6 \pm 0.15	0.8 \pm 0.15	0.5 \pm 0.1	0.3 \pm 0.2
			0.8 \pm 0.15	
0805	2.0 +0.3/-0.1	1.25 \pm 0.2	0.5 \pm 0.1	0.5 \pm 0.3
			0.9 \pm 0.1	
			1.25 \pm 0.2	
0806	2.0 +0.3/-0.1	1.6 \pm 0.2	0.9 \pm 0.1	0.5 \pm 0.3
			1.1 \pm 0.1	
1008	2.5 \pm 0.2	2.0 +0.3/-0.1	0.9 \pm 0.1	0.5 \pm 0.3
			1.1 \pm 0.1	

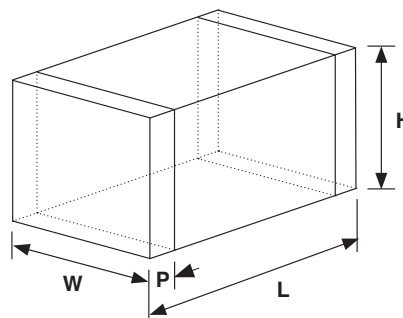

PART NUMBER SYSTEM

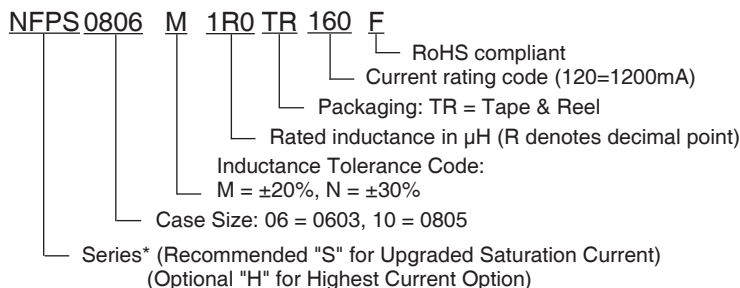

*NFP vs. NFPS vs. NFPH Performance Comparison

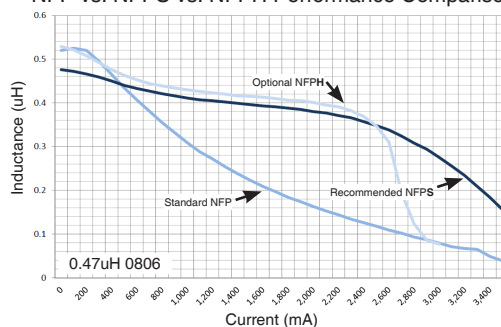

NFP0603 SERIES

0603 CASE SIZE

NIC Partnumber	Inductance (μH)	Tolerance	Test Frequency	SRF MHz (min.)	DC Resistance (Ω)	I _{rms} (mA)	I _{sat} (mA)	Component Thickness (mm)
NFP0603NR47TR90F	0.47	±30% (N)	1MHz	105	0.19 ± 25%	900	-	0.5 ± 0.1
NFPS0603_R22TR125F	0.22	±20% (M), ±30% (N)		200	0.10 ± 25%	1250	1600	0.8 ± 0.15
NFPS0603_R33TR120F	0.33	±20% (M), ±30% (N)		190	0.13 ± 25%	1200	1500	
NFP0603NR47TR120F	0.47	±30% (N)		105	0.12 ± 25%	1200	-	
NFPS0603_R47TR110F	0.47	±20% (M), ±30% (N)		180	0.15 ± 25%	1100	1200	
NFP0603NR68TR100F	0.68	±30% (N)		90	0.16 ± 25%	1000	-	
NFPS0603_R68TR115F	0.68	±20% (M), ±30% (N)		160	0.18 ± 25%	1150	1100	
NFP0603N1R0TR95F	1.0	±30% (N)		60	0.20 ± 25%	950	-	
NFPS0603_1R0TR100F	1.0	±20% (M), ±30% (N)		125	0.20 ± 25%	1000	800	
NFPS0603_1R5TR90F	1.5	±20% (M), ±30% (N)		100	0.23 ± 25%	900	500	
NFP0603N2R2TR75F	2.2	±30% (N)		40	0.30 ± 25%	750	-	
NFPS0603_2R2TR85F	2.2	±20% (M), ±30% (N)		80	0.30 ± 25%	850	300	

Maximum +40°C temperature rise at I_{rms}. Maximum -30% inductance drop from initial measured value at I_{sat}.

NFP0805 SERIES

0805 CASE SIZE

NIC Partnumber	Inductance (μH)	Tolerance	Test Frequency	SRF MHz (min.)	DC Resistance (Ω)	I _{rms} (mA)	I _{sat} (mA)	Component Thickness (mm)
NFP0805MR22TR150F	0.22	±20% (M)	1MHz	100	0.09 ± 25%	1500	-	0.5 ± 0.1
NFP0805_R47TR110F	0.47	±20% (M), ±30% (N)		100	0.12 ± 25%	1100	-	
NFPS0805_R47TR110F	0.47	±20% (M), ±30% (N)		80			1300	
NFP0805_1R0TR80F	1.0	±20% (M), ±30% (N)		60	0.19 ± 25%	800	-	
NFPS0805_1R0TR80F	1.0	±20% (M), ±30% (N)		40			700	
NFP0805_1R5TR70F	1.5	±20% (M), ±30% (N)		50	0.26 ± 25%	700	-	
NFPS0805_1R5TR70F	1.5	±20% (M), ±30% (N)		35			500	
NFP0805_2R2TR60F	2.2	±20% (M), ±30% (N)		40	0.34 ± 25%	600	-	
NFPS0805_2R2TR60F	2.2	±20% (M), ±30% (N)		30	0.32 ± 25%		350	
NFP0805_R47TR120F	0.47	±20% (M), ±30% (N)		100	0.09 ± 25%	1200	-	
NFPS0805_R47TR150F		±20% (M), ±30% (N)		100	0.08 ± 25%	1500	1200	
NFP0805_1R0TR100F	1.0	±20% (M), ±30% (N)		60	0.11 ± 25%	1000	-	
NFPS0805_1R0TR130F		±20% (M), ±30% (N)		60	0.11 ± 25%	1300	1150	
NFP0805_1R5TR90F	1.5	±20% (M), ±30% (N)		50	0.16 ± 25%	900	-	
NFPS0805_1R5TR110F		±20% (M), ±30% (N)		50	0.16 ± 25%	1100	800	
NFP0805_2R2TR80F	2.2	±20% (M), ±30% (N)		40	0.25 ± 25%	800	-	
NFPS0805_2R2TR90F		±20% (M), ±30% (N)		40	0.20 ± 25%	900	500	
NFP0805_3R3TR90F	3.3	±20% (M), ±30% (N)		30	0.19 ± 25%	900	-	
NFPS0805_3R3TR90F		±20% (M), ±30% (N)		30	0.20 ± 25%	900	350	
NFP0805_4R7TR80F	4.7	±20% (M), ±30% (N)		30	0.25 ± 25%	800	-	
NFPS0805_4R7TR80F		±20% (M), ±30% (N)	30	0.25 ± 25%	800	280		
NFP0805M100TR50F	10	±20% (M)	15	0.5 ± 30%	500	-	1.25 ± 0.2	

Maximum +40°C temperature rise at I_{rms}. Maximum -30% inductance drop from initial measured value at I_{sat}.



Note: Extended values, tolerances, and enhanced versions are available please contact NIC for more details.

NFP0806 SERIES

0806 CASE SIZE

NIC Partnumber	Inductance (μH)	Tolerance	Test Frequency	SRF MHz (min.)	DC Resistance (Ω)	I _{rms} (mA)	I _{sat} (mA)	Component Thickness (mm)
NFP0806_R47TR160F	0.47	±20% (M), ±30% (N)	1MHz	100	0.06 ± 25%	1600	-	0.9 ± 0.1
NFPS0806MR47TR150F		20%			0.08 ± 25%	1500	1600	
NFPH0806MR47TR230F		±20% (M), ±30% (N)			90	0.04 ± 25%	2300	
NFPH0806MR68TR180F	0.68	±20% (M), ±30% (N)		80	0.06 ± 25%	1800	2000	
NFP0806_1R0TR140F	1.0	±20% (M), ±30% (N)		70	0.09 ± 25%	1400	-	
NFPS0806M1R0TR140F		20%		1200				
NFPH0806M1R0TR150F		±20% (M), ±30% (N)		60	0.07 ± 25%	1500	1800	
NFP0806_1R5TR120F	1.5	±20% (M), ±30% (N)		60	0.11 ± 25%	1200	-	
NFPS0806M1R5TR120F		20%		700				
NFP0806_2R2TR120F	2.2	±20% (M), ±30% (N)		50	0.11 ± 25%	1200	-	
NFPS0806M2R2TR120F		20%		500				
NFP0806_3R3TR120F	3.3	±20% (M), ±30% (N)		40	0.12 ± 25%	1200	-	
NFPS0806M3R3TR120F		20%		330				
NFP0806_4R7TR110F	4.7	±20% (M), ±30% (N)		30	0.14 ± 25%	1100	-	
NFPS0806M4R7TR110F		20%		220				
NFP0806M100TR80F	10	±20% (M)	15	0.25 ± 25%	800	-	1.1 ± 0.1	

Maximum +40°C temperature rise at I_{rms}. Maximum -30% inductance drop from initial measured value at I_{sat}.

NFP1008 SERIES

1008 CASE SIZE

NIC Partnumber	Inductance (μH)	Tolerance	Test Frequency	SRF MHz (min.)	DC Resistance (Ω)	I _{rms} (mA)	I _{sat} (mA)	Component Thickness (mm)	
NFP1008_R47TR180F	0.47	±20% (M), ±30% (N)	1MHz	100	0.04 ± 25%	1800	-	0.9 ± 0.1	
NFPS1008_R47TR180F		±20% (M), ±30% (N)		105			1500		
NFP1008_1R0TR160F	1.0	±20% (M), ±30% (N)		60	0.06 ± 25%	1600	-		
NFPS1008_1R0TR160F		±20% (M), ±30% (N)		70			1400		
NFP1008_1R5TR150F	1.5	±20% (M), ±30% (N)		50	0.07 ± 25%	1500	-		
NFPS1008_1R5TR150F		±20% (M), ±30% (N)		65			1200		
NFP1008_2R2TR130F	2.2	±20% (M), ±30% (N)		40	0.08 ± 25%	1300	-		
NFPS1008_2R2TR130F		±20% (M), ±30% (N)		55			850		
NFP1008_3R3TR120F	3.3	±20% (M), ±30% (N)		30	0.10 ± 25%	1200	-		
NFPS1008_3R3TR120F		±20% (M), ±30% (N)		450					
NFP1008_4R7TR110F	4.7	±20% (M), ±30% (N)		25	0.11 ± 25%	1100	-		
NFPS1008_4R7TR110F		±20% (M), ±30% (N)		320					
NFP1008_1R0TR150F	1.0	±20% (M), ±30% (N)		70	0.09 ± 25%	1500	-		1.1 ± 0.1
NFP1008_2R2TR100F	2.2	±20% (M), ±30% (N)		40	0.12 ± 25%	1000	-		
NFP1008_3R3TR100F	3.3	±20% (M), ±30% (N)		30	0.12 ± 25%	1000	-		
NFP1008_4R7TR90F	4.7	±20% (M), ±30% (N)	25	0.14 ± 25%	900	-			
NFP1008M100TR80F	10	±20% (M)	15	0.30 ± 30%	800	-			

Maximum +40°C temperature rise at I_{rms}. Maximum -30% inductance drop from initial measured value at I_{sat}.



ENVIRONMENTAL CHARACTERISTICS

Test	Specification	Test Method & Condition
Resistance to Soldering Heat	No Mechanical Damage Inductance: $\pm 20\%$ of initial value (parts should be stabilized at room temperature for 2 hours prior to testing)	+260°C for 5 seconds
Low Frequency Vibration		Cycle 10Hz ~ 55Hz ~ 10Hz (1 minute), 2 hours each axis (X, Y, Z)
Thermal Shock		Cycle -40°C for 30 min. > +85°C 30 min., 100 cycles
Humidity		+60°C, 90% ~ 95%RH, 1,000 hours
Low Temperature Storage		-40°C for 1,000 hours
High Temperature Load Life		+85°C for 1,000 hours

LAND PATTERN DIMENSIONS

Series	A	B	C
NFP0603	0.6 ~ 0.8	0.6 ~ 0.8	0.6 ~ 0.8
NFP0805	0.8 ~ 1.2	0.9 ~ 1.6	0.8 ~ 1.2
NFP0806	0.8 ~ 1.2	1.2 ~ 2.0	0.8 ~ 1.2
NPF1008	0.6 ~ 1.0	1.8 ~ 2.2	1.0 ~ 1.4

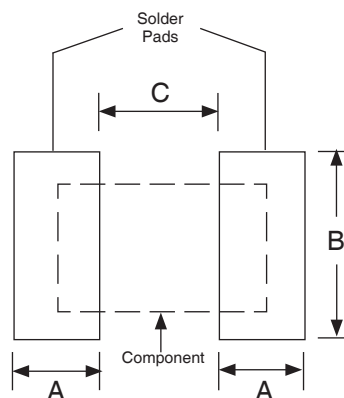

REFLOW SOLDERING PROFILE

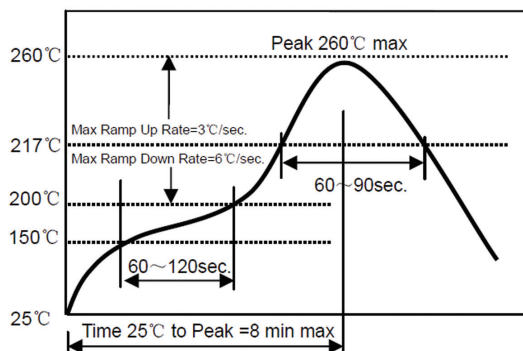

COMPOSITION

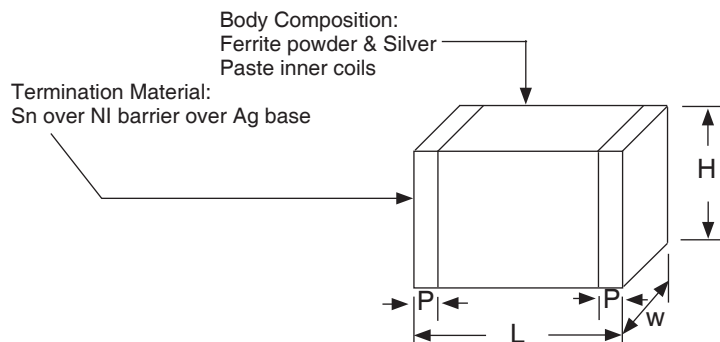

CARRIER DIMENSIONS & REEL QUANTITY (mm)

TYPE	Part Thickness	A	B	K max.	T max.	Carrier Material	Reel Qty
NFP0603	0.5	1.0 ± 0.2	1.8 ± 0.2	-	0.8	Paper	5,000
	0.8				1.1		4,000
NFP0805	0.5	1.55 ± 0.10	2.30 ± 0.10	1.45	0.8		Plastic
	0.9			1.75		3,000	
NFP0806	0.9	1.90 ± 0.10	2.30 ± 0.10	1.45	0.3		
	1.1			1.75			
NFP1008	0.9	2.30 ± 0.10	2.80 ± 0.10	1.45	0.3	Plastic	3,000
	1.1			1.75			

PAPER CARRIER DIMENSIONS (mm)

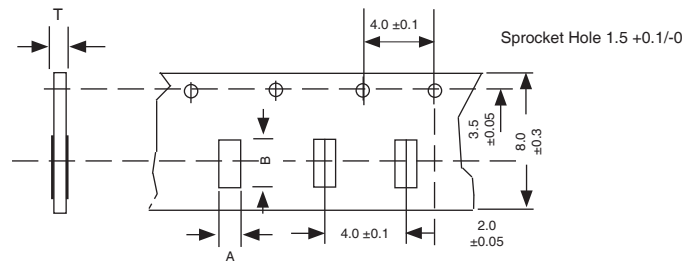

EMBOSSED PLASTIC CARRIER DIMENSIONS (mm)

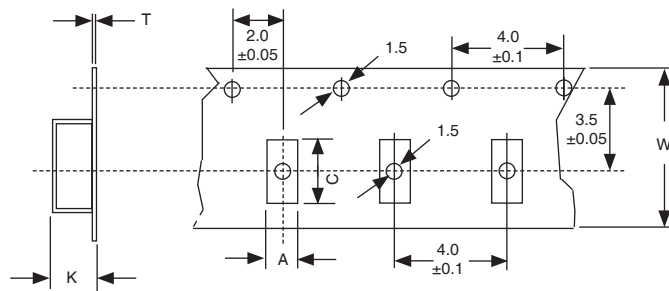

REEL DIMENSIONS (mm):

