

Linear actuator DSZY1Q-STD (Standard)

The electric linear actuators of the DSZY1Q series are especially characterized by their smooth running and low noise level. They are available in three models:

1. **DSZY1Q-STD**
(standard for all applications without position feedback)
2. DSZY1Q-POT
(with potentiometer for absolute position feedback)
3. DSZY1Q-HS2
(with 2-channel Hall sensor for incremental position feedback)

Equipped with a trapezoidal screw spindle (ACME screw), these are small, compact and lightweight DC linear drives. By means of an integrated diode circuit, the direction is reversed quickly by simple voltage reversal of the DC motor. As a standard, all DSZY1Q types have two integrated, non-adjustable limit switches directly connected to the DC motor. Overloading of the drive can be prevented by separate monitoring and limiting of the current.



Type code (all options can be combined)

DSZY1Q - 12 - 10 - 200 - STD - IP65						Optional		
Type	Input voltage	Gear reduction i	Stroke	Model	IP Code	C	1	1
	12 Vdc 24 Vdc	20 30	25 mm 50 mm 100 mm 150 mm 200 mm 250 mm 300 mm	Standard			Front connector (piston rod)	Rear connector (gear cover)
							1 = standard 3 = spherical rod eye 6 = plastic slot	1 = standard 3 = rotated 90°

Performance data: Load – Speed – Current

Gear reduction i	Dynamic Load (N)	Static load (N)	Typical speed * (mm/s)		Typical current * (A)			
			minimum load	maximum load	minimum load		maximum load	
					12 Vdc	24 Vdc	12 Vdc	24 Vdc
20	500	2,500	5.8	3.9	0.2	0.1	1.0	0.5
30	800	2,500	3.8	2.6	0.2	0.1	1.2	0.6

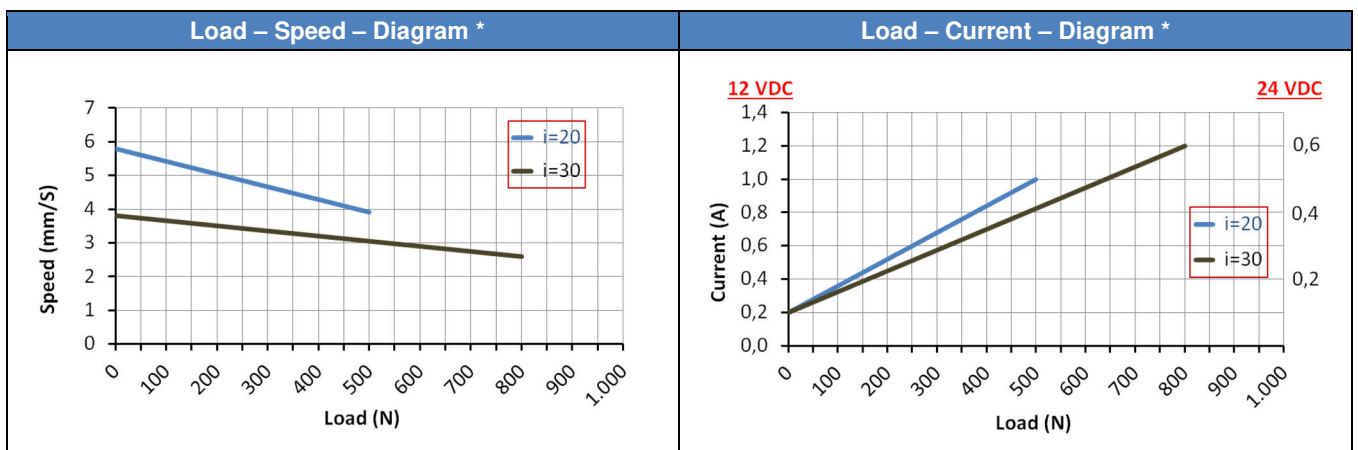

(*) Average values

Additional technical specifications

- Operating voltage 12 Vdc and 24 Vdc
- Thrust and tensile load up to 800 N
- Static load 2,500 N
- Noise level: ≤ 55 dB
- Duty cycle 25 % (e.g. 1 min continuous operation – 3 min pause)
- Zinc alloy casing
- Aluminum outer tube and push rod
- Working temperature -25 °C – 65 °C
- IP Code IP65 for all models
- Piston rod secured against rotation – see installation instructions
- CE - EMV 2014/30/EU (EN 55014-1:2006+A1:2009+A2:2011 EN 55014-2:1997+A1:2001+A2+:2008 Category I)

Dimensions

Front connector	Dimensions (length) in mm							
	Stroke (S) ± 3 mm	25	50	100	150	200	250	300
C1.. (Standard)	(A) retracted	128	158	209	260	311	362	413
	(A+S) extended	153	208	309	410	511	612	713
C3..	(A) retracted	169	199	250	301	350	403	454
	(A+S) extended	194	249	350	451	550	653	754
C6..	(A) retracted	138.5	168.5	219.5	270.5	321.5	372.5	423.5
	(A+S) extended	163.5	218.5	319.5	320.5	521.5	622.5	723.5

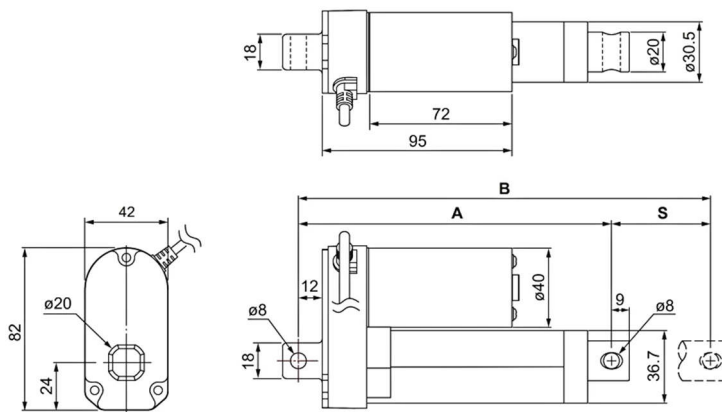

Bore tolerances: 8 mm $+0,2\text{ mm}$
 -0 mm

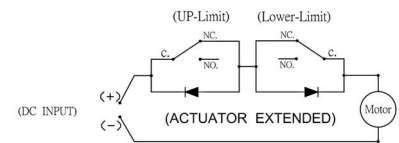

Red wire on "+" and black wire on "-":
Actuator extends.

Black wire on "+" and red wire on "-":
Actuator retracts.

Cable length: 900 mm

Weight

Stroke in mm	25	50	100	150	200	250	300
Weight in kg	0.820	0.860	0.930	1.000	1.070	1.140	1.200

Front and rear connector

Front connector (piston rod)		
1 = standard (metal)	3 = spherical rod eye	6 = plastic slot
D=8 mm - H=15 mm - W=6 mm		



Rear connector (gear cover)	
1 = Standard	3 = 90° rotated
D=8 mm	

CAUTION:

C11 is standard and will not be specified in the type code.

If at least one connector is changed, option C must be attached to the type code (e.g., DSZY1...-IP65-C63)

Mounting material

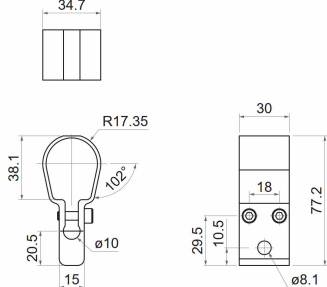
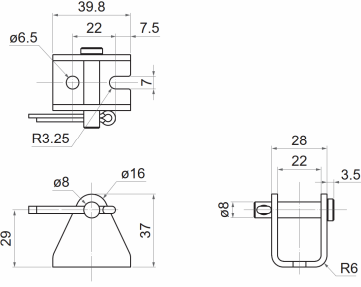
Mounting clamp DSZY1-H01	Mounting bracket DSZY1-H02
	
	

Installation instructions

It must be ensured that the load is not greater than shown in the diagram. To protect against overload, the voltage must be switched off when the maximum rated current is reached. This can be read in the load-current diagram depending on the selected reduction ratio. Please note the correct supply voltage, which is indicated on the electric linear actuator.

The piston rod extends when the red wire is connected to positive and the black wire to negative. For the retraction of the piston rod, positive must be reversed with negative. The movement always stops automatically when the built-in limit switches are reached or when the voltage is interrupted. The limit switches cannot be changed by the customer.

The load must always be centered in the direction of movement. Transverse forces must be avoided. They shorten the service life and can impede the function or lead to irreparable damage in extreme cases.

The piston rod tube is screwed onto the spindle nut via a thread. It is therefore possible, if necessary, to rotate the piston rod and thus the fastening eye by max. 180° into the desired position.

If no rotational forces act on the piston rod, the latter retains its orientation and does not rotate.

CAUTION: The limit switches have no on/off function for the linear actuator. Therefore, the voltage must be immediately disconnected after the limit switches have been triggered, or the piston must be moved out of the end position in a timely manner.



Drive System Europe by MSW®

A trade mark of MSW Motion Control GmbH

MSW Motion Control GmbH
Vertriebsgesellschaft
Schloßstr. 32/34, 33824 Werther (Westf.)
Deutschland

anfrage@msw-motion.de
www.msw-motion.de
Tel.: +49 (0)5203 919200