

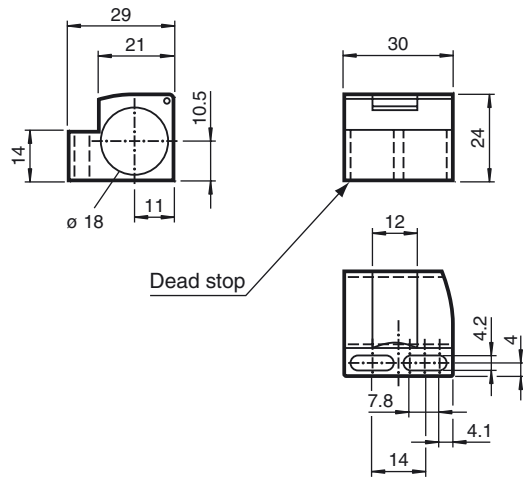

Dimensions



Model Number

BF 18-F

Mounting flange with dead stop, 18 mm

Features

- Black plastic housing with dead stop for all cylindrical sensors with M18 thread
- Easy sensor replacement via fixing flap in the top of the fixing flange
- Embeddable sensors lie flush with the surface of the fixing flange
- The cap of a non-embeddable sensor protrudes through the fixing flange. This allows non-embeddable sensors to be easily mounted on metal surfaces.
- max. 8 mm range of adjustment is provided for the positioning of the flange by means of the elongated holes on the side

Technical data

General specifications

Inside diameter 18 mm

Ambient conditions

Ambient temperature -25 ... 85 °C (248 ... 358 K)

Mechanical specifications

Material Polycarbonate (PC), black

Note

Installation

- Position the mounting bracket on the desired place
- Mark the position of drilling holes in the mid section of the oblong holes
- Drill the mounting holes through the surface
- Screw on the mounting bracket slightly via the lateral oblong holes by using suitable M4 screws
- Stick the sensor through the mounting bracket and fix the sensor by the lid on the upper part of the bracket
- Adjust the bracket and make the final positioning
- Fix the mounting bracket finally with the screws

Release date: 2009-04-20 16:35 Date of issue: 2009-04-20 107460_ENG.xml