

REELY

Ⓒ Operating Instructions

Electro-Quadrocopter “Q” RtF

Item No. 1526041

CE

Table of Contents



	Page
1. Introduction	4
2. Explanation of Symbols	4
3. Intended Use	5
4. Product Description	5
5. Scope of Delivery	6
6. Safety Notes	7
a) General	7
b) Before Commissioning	7
c) During Operation	8
7. Battery and Rechargeable Battery Notes	9
a) Transmitter	9
b) Flight Battery	9
8. Start Preparations	10
a) Inserting the Batteries in the Transmitter	10
b) Charge Flight Battery	11
9. Operating Elements of the Transmitter	12
10. Safety Devices	13
a) Transmitter	13
b) Model	13
11. Information for First Take-Off	14
a) Hover Flight	14
b) Yaw Function	15
c) Nod Function	15
d) Roll Function	16
e) Flight Mode	16
12. The First Start	17
a) Start	17
b) Flight Movements	18
c) Trimming	19
d) Flip Function	20

	Page
13. Maintenance and Repair.....	21
a) Regular Cleaning.....	21
b) Replacing the Rotors.....	21
c) Calibration.....	22
14. Disposal.....	22
a) Product.....	22
b) Batteries/Rechargeable Batteries.....	22
15. Declaration of Conformity (DOC).....	23
16. Technical Data.....	23
a) Transmitter.....	23
b) Quadcopter.....	23
c) USB Charger.....	23

1. Introduction

Dear Customer,

thank you for purchasing this product.

This product complies with the statutory national and European requirements.

To maintain this status and to ensure safe operation, you as the user must observe these operating instructions!



These operating instructions are part of this product. They contain important notes on commissioning and handling. Also consider this if you pass on the product to any third party. Therefore, retain these operating instructions for reference!

If there are any technical questions, please contact:

International: www.conrad.com/contact

United Kingdom: www.conrad-electronic.co.uk/contact

2. Explanation of Symbols



The exclamation mark in a triangle indicates important notes in these operating instructions that must be observed strictly.



The arrow symbol indicates that special advice and notes on operation are provided.

3. Intended Use

The electrical quadcopter "Q" is a helicopter-like model solely designed for private use in the model making area and the operating times associated with this.

This system is not suitable for other types of use. Any use other than that described above can damage the product and involves additional risks such as short circuit, fire, electric shock, etc. The safety information must be observed at all times!

The product must not get damp or wet.

This product is not a toy and not suitable for children under 14 years of age.

→ Observe all safety information in these operating instructions. They contain important information on handling of the product.

You are solely responsible for safe operation of the model!

4. Product Description

The quadcopter "Q" is a pre-assembled helicopter-like flight model with four rotors. In the professional field, such flight devices are already used for the most diverse of tasks.

The latest micro processor controlled electronics with position control and acceleration sensor stabilise the quadcopter "Q".

High-quality direct current engines in connection with a specially developed control permit a powerful flight operation. The new control and electronic self-stabilisation lead to great flight properties.

The product is intended for operation in closed rooms but may also be used outdoors in wind still conditions. The in-built electronic controls (integrated 6-axis gyro) can balance out small undesired changes to the flight altitude, but cannot remove them completely. As the "Q" quadcopter weighs approx. 12 g, it reacts sensitively to wind or draughts.

5. Scope of Delivery

- Pre-installed quadrocopter "Q"
- Transmitter
- USB charger
- Two spare rotors (front)
- Two spare rotors (rear)
- Operating instructions

Current operating instructions

Download the current operating instructions via the link www.conrad.com/downloads or scan the QR code displayed. Observe the instructions on the website.



→ The spare part list can be found on our website www.conrad.com in the download section for the respective product. Alternatively, you may also email to request the list of spare parts. For contact information, see the chapter "Introduction" at the beginning of these operating instructions.

6. Safety Notes



In case of damage caused by non-compliance with these operating instructions, the warranty/guarantee will expire. We do not assume any liability for consequential damage!

We do not assume any liability for property damage or personal injury caused by improper use or non-compliance with the safety instructions! In such cases the warranty/guarantee is voided.

Normal wear and tear and accident and crash damage (e.g. broken rotor blades or chassis parts) are also excluded from the guarantee and warranty.

Dear Customer,

this safety information serves not only to protect the product, but also your own safety and the safety of other persons. Therefore, read this chapter very carefully before taking the product into operation!

a) General

Caution, important note!

Operating the model may cause damage to property and/or individuals.

Therefore, make sure that you are sufficiently insured when using the model, e.g. by taking out private liability insurance. If you already have private liability insurance, verify whether or not operation of the model is covered by your insurance before commissioning your model.

Observe: In some EU countries, you are required to have insurance for any flying models!

- The unauthorized conversion and/or modification of the product or its components is inadmissible for safety and approval reasons.
- This product is not a toy and not suitable for children under 14 years of age.
- The product must not get damp or wet.
- Do not leave any packaging material unattended. It may become a dangerous playing material for children.
- Should questions arise that are not answered by these operating instructions, contact us (for contact information, see chapter 1) or another expert.

b) Before Commissioning

- Make sure that no other models are operated within the range of the remote control on the same 2.4 GHz band (transmitter frequency). Always check if concurrently operated 2.4 GHz transmission systems interfere with your model.
- Regularly check the functional safety of your model and of the remote control system. Watch out for any visible damage such as damaged mechanics (e.g. rotors).
- All moving parts on the model must run smoothly but must not have any tolerance in the bearing.
- Check before each operation the correct and secure position of the rotors.
- The flight battery required for operation must be charged according to these operating instructions.



- Ensure sufficient residual capacity (battery tester) of the batteries inserted in the transmitter. If the batteries are empty, always replace the complete set, never individual cells only.
- When the rotors are running, make sure that neither objects nor body parts are in the rotating and suction area of the rotors.

c) During Operation

- Do not take any risks when operating the model! Your own safety and that of your environment depends completely on your responsible use of the model.
- Improper operation can cause serious damage to people and property! Therefore make sure to keep a sufficiently safe distance from persons, animals or objects during operation.
- Select an appropriate location for the operation of your model.
- Fly your model only if your ability to respond is unrestricted. The influence of tiredness, alcohol or medication can cause incorrect responses.
- Do not direct your model towards spectators or towards yourself.
- Motor, electronics and flight battery may heat up during operation of the model. For this reason, take a break of 5 to 10 minutes before recharging the firmly integrated flight battery in the quadcopter.
- Never switch off the remote control (transmitter) while the model is in use. After landing, always first switch the on/off switch at the quadcopter to the off position ("OFF"). Only then may the remote control be switched off.
- In case of a defect or a malfunction, remove the problem before using the model again.
- Never expose your model or the remote control to direct sunlight or excessive heat for an extended period of time.
- In the case of a severe crash (e.g. from a high altitude). The electric gyro sensors can be damaged. Therefore, full functionality must be tested before flying again without fail!
- Switch off the rotor motors at once after a crash. Rotating rotors may be damaged if they come into contact with obstacles e.g. overcharging. Before flying again, these should be checked for possible tears or breakages!
- To avoid damage to the model through crashing due to low voltage or deep discharge of the rechargeable battery through total discharge, we recommend that you respect the low voltage light signals without fail.

7. Battery and Rechargeable Battery Notes



Although use of batteries and rechargeable batteries in everyday life is a matter of course today, there are many dangers and problems. In particular in LiPo/Lilon batteries with high energy content (as compared to conventional NiCd or NiMH batteries), various provisions must be complied with to avoid danger of explosion and fire.

The model is delivered with a firmly installed, non-replaceable rechargeable battery and a matching charger. Nevertheless, we are including extensive information on handling batteries for safety reasons. Should you use your own accessories, please ensure you follow all information enclosed by the respective manufacturer.

a) Transmitter

- Keep batteries/rechargeable batteries out of the reach of children.
- Do not leave any batteries/rechargeable batteries lying around openly. There is a risk of batteries being swallowed by children or pets. If swallowed, consult a doctor immediately!
- Batteries/rechargeable batteries must never be short-circuited, disassembled or thrown into fire. There is a danger of explosion!
- Leaking or damaged batteries/rechargeable batteries can cause chemical burns to skin on contact; therefore, use suitable protective gloves.
- Do not recharge normal batteries. There is a risk of fire and explosion!
- Make sure that the polarity is correct when inserting the batteries (pay attention to plus/+ and minus/-).
- If the device is not used for an extended period of time (e.g. storage), remove the inserted batteries from the remote control to avoid damage from leaking batteries.
- Always replace the whole set of batteries. Do not mix full batteries with half-full ones. Always use batteries/rechargeable batteries of the same type and manufacturer.
- Never mix batteries and rechargeable batteries!

b) Flight Battery

Attention!

Leave the on-off switch of the quadcopter in the "off" position ("OFF") when you are not using the flight model (e.g. during transport or storage). Otherwise, the LiPo flight battery may be deep-discharged and is thus destroyed and rendered useless! There is also a danger of malfunction due to interferences. The rotors could start up inadvertently and cause damage or injury.

- Never charge the LiPo flight battery immediately after use. Always leave the LiPo flight battery to cool off first (at least 5 - 10 minutes).
- Charge the LiPo flight battery firmly installed in the quadcopter only via the enclosed USB-LiPo-charger.
- Only charge intact and undamaged batteries. If the outer isolation of the rechargeable battery is damaged or the battery is deformed or bloated, it must not be charged. In this case, there is immediate danger of fire and explosion!



- Place the model on a fire-resistant surface for charging (e.g. a plate). Keep a distance to flammable objects (use USB extension cable if required).
- As the charger and the rechargeable LiPo flight battery both heat up during the charging procedure, it is necessary to ensure sufficient ventilation. Never cover the charger or the quadcopter!
- Never leave LiPo batteries unattended while charging them.
- Remove the quadcopter from the charger when it is fully charged.
- The charger is intended for dry indoor use only. The charger and the quadcopter must not become damp or wet.
- There is the risk of fire or explosion by the rechargeable battery in case of error. LiPo batteries specifically react very strongly at moisture and oxygen due to the chemicals contained in them! Do not expose the charger or quadcopter to high/low temperatures or to direct solar radiation.

8. Start Preparations

a) Inserting the Batteries in the Transmitter

Remove the battery compartment lid on the back of the transmitter. For this, you need to remove the screw and lift off the lid (1).

Insert two micro/AAA size batteries with the correct polarity (2). Observe the corresponding icons in the battery compartment. Attach the battery casing lid and screw it back on (3).

→ Operation of the transmitter with batteries is not recommended because of the lower cell voltage (battery = 1.5 V, rechargeable battery = 1.2 V) and the self-discharge of rechargeable batteries. Quick feedback of the transmitter on low charge status of the transmitter power supply would result.

Since the transmitter requires very little power, batteries will keep much longer. We recommend the use of high-quality alkaline batteries.

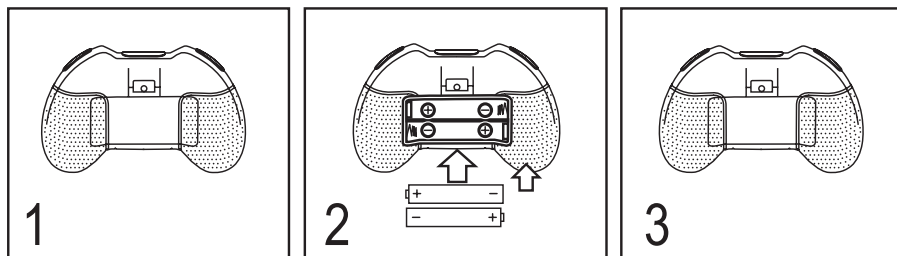

Figure 1

b) Charge Flight Battery

A suitable USB mains unit or USB cigarette lighter adapter (neither enclosed) may be used for power supply to the enclosed USB charger; they each must have an output current of at least 500 mA.

Alternatively, the USB port of a computer or USB hub with a dedicated mains unit can be used as well that can supply a current of 500 mA per port.

Connect the USB charger from the delivery to the USB power supply with its USB plug (1) (as described above, e.g. a USB mains unit or similar). Then connect the small plug (2) of the USB charger to the corresponding socket of the quadcopter (3). Observe proper alignment of the plug (the plug contour must match the socket in the quadcopter).

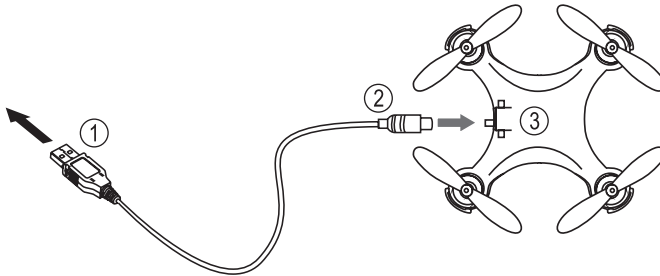

Figure 2

If the battery is not defective (high-Ohmic/interrupted) and power supply is warranted, charging commences. This is signalled by the red LED in the USB charger.

The following LED displays are possible:

LED is permanently lit: The battery is being charged

LED is off: The battery is full or fully charged

9. Operating Elements of the Transmitter

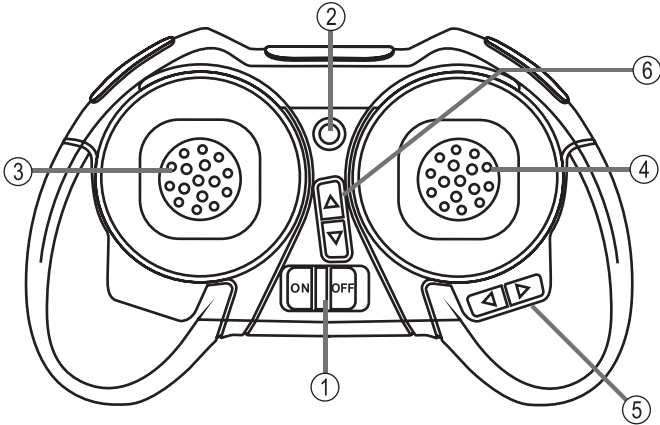

Figure 3

- 1 On/off switch
- 2 LED for function control
- 3 Left control stick (motor speed and yaw)
- 4 Right control stick (roll and nod)
- 5 Roll trimming
- 6 Nod trimming

10. Safety Devices

→ The quadcopter "Q" has a range of safety devices in the transmitter and flight model which protect the model from damage and/or should reduce possible damage to a minimum. The protection mechanisms are identified by LED indicators (flight model) or an acoustic warning signal (transmitter).

a) Transmitter

The battery condition is continually inspected while the transmitter is in operation. If the voltage level of the batteries drops below a certain value, the transmitter will signal this with an intermittent warning sound and permanent flashing of the LED at the transmitter (figure 3, item 2). In this case, stop flying at once and replace the batteries of the transmitter.

b) Model

The LEDs in the quadcopter (in the landing struts) show if the transmitter is "bound" to the model and reception of the control signal is proper. This is displayed by permanently lit LEDs. When the front LEDs flash, the quadcopter does not correctly receive the transmitter signal. In this case, "binding" must be performed again.

The quadcopter constantly monitors the voltage of the integrated flight battery. Should this fall below a critical level during a particular period, this will be indicated by the flashing front LEDs.

If the voltage undercut is permanently below a specific value, an emergency landing is initiated after a brief time and the motors are switched off.

→ If the undervoltage is displayed at the quadcopter by flashing of the front LEDs, only approx. 20 to 30 seconds of flight time remain to independently return the model to the starting point and land it.

If a certain voltage level of the flight battery is reached, the motor control will be switched off by the transmitter and automatic landing is initiated. This process cannot be influenced by the transmitter anymore.



If the model is above a body of water, tree, house, street, persons, animals, etc. at the time and/or if the model is flying more than 1 metre above ground, the model may be damaged or lost and there may be property damage and injury to persons/animals nearby.

11. Information for First Take-Off

a) Hover Flight

→ For a simpler and consistent explanation of steering, classic terminology is used here as well. This comes from flight language and is widely used.

Directional descriptions are always to be interpreted from the perspective of a "virtual" pilot in the model. The two black rotors are considered direction indicators. They mean "front". The explanations are all based on configuration of the remote control to mode II.

Hovering denotes a flight status in which the quadcopter neither rises nor falls so that the upwards directed uplift force is equal to the downwards directed weight.

Push the throttle lever (figure 3, item 3) forward to increase the motor speed and lift up the quadcopter. Pulling the throttle lever back causes the quadcopter to drop. If you leave the throttle stick in the middle area, the quadcopter will roughly maintain its height.

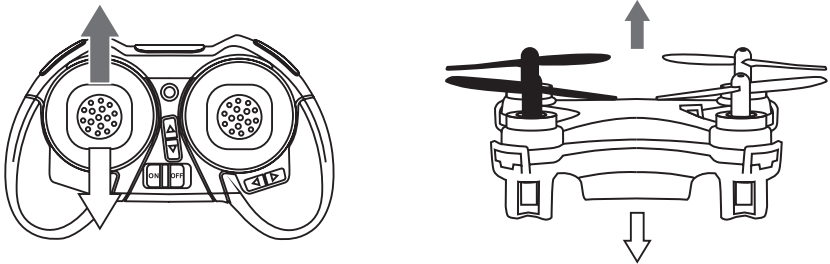

Figure 4

→ During flight close above the ground and during take-off, turbulence and air flow can be experienced which may affect the quadcopter. A quicker response to the controlling motions and slight swerving of the quadcopter forwards, backwards or to the side may result from this. This so-called ground effect is no longer present starting at a flight height of about 50 cm.

b) Yaw Function

"Yaw" denotes the rotation of the quadcopter around the yaw axis (vertical axis). This movement either occurs unintentionally due to the speed torque of the rotors or intentionally as a flight direction change. This movement is caused by speed changes of the individual rotors towards each other in the quadcopter.

If you move the left control lever to the left, the quadcopter will turn to the left. If you move the control lever to the right, the quadcopter will turn to the right.

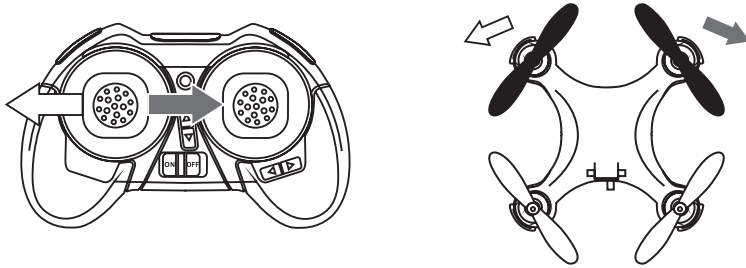

Figure 5

c) Nod Function

"Nod" denotes the movement around the cross axis which can be compared to the nodding of a head. Through this, the quadcopter gains flight speed forwards or backwards or decelerates.

If you move the right control lever to the front, the quadcopter will float forwards as a whole. If you move the control lever to the rear, the quadcopter will float backwards. If the quadcopter drifts slowly to the rear in hover flight (direction of the white arrow), the model must be trimmed with the trim (see chapter "Trimming").

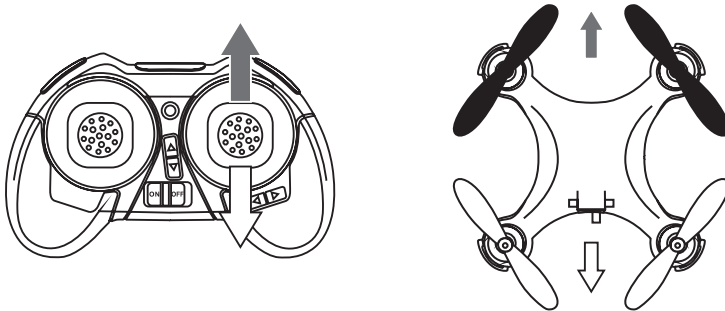

Figure 6

d) Roll Function

"Roll" denotes the movement around the centre line which can be compared to the sideways rolling of a ball (or the sideways crawl of a crab). In this way, through lifting one side the quadcopter moves independent of its forward direction to the side.

If you move the right control lever to the left, the quadcopter will float to the left as a whole. If you move the control lever to the right, the quadcopter will float to the right. If the quadcopter drifts slowly to the left in hover flight (direction of the white arrow), the model must be trimmed with the trim (see chapter "Trimming").

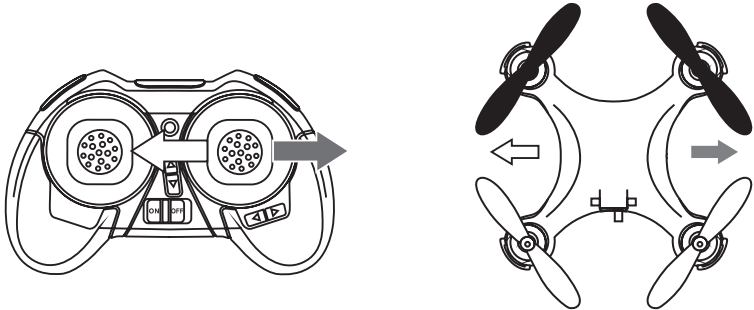

Figure 7

e) Flight Mode

The quadcopter permits you to choose between three different flight modes depending on your experience.

Change the flight mode by briefly pushing the left control lever at the transmitter (see figure 8).

In beginner mode, the control commands are limited to permit you learning how to fly the quadcopter very quickly and easily. This flight mode is recommended for pilots who have no or only very little flight experience with helicopters or quadcopters yet. The beginner's mode is the basic configuration after switching the transmitter on each time.

The advanced mode is recommended to pilots who have already collected some experience with other quadcopter models. In this mode, the quadcopter is much more agile in its control conduct than in beginner's mode. In order to activate this mode, push the left control stick at the transmitter (figure 8) briefly repeatedly until you hear a double sound.

The professional mode is recommended to pilots who have already collected a lot of experience with other quadcopter models. In this mode, the quadcopter is even more agile in its control conduct than in advanced mode. In order to activate professional mode, push the left control stick at the transmitter (figure 8) briefly repeatedly until you hear a triple sound.

Pushing the left control stick again will return you to beginner's mode. This is signalled by a single control sound.

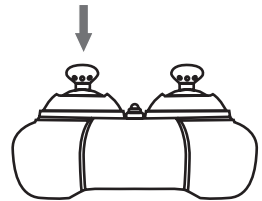

Figure 8

12. The First Start

a) Start



The operation and handling of remote controlled flight models must be learned! If you have never steered such a model, start especially carefully and get used to the reactions of the model to the remote control commands first. Do be patient! Use the information from chapter 11 as reference.

Do not take any risks when operating the product! Your own safety and that of your environment depends completely on your responsible use of the model.

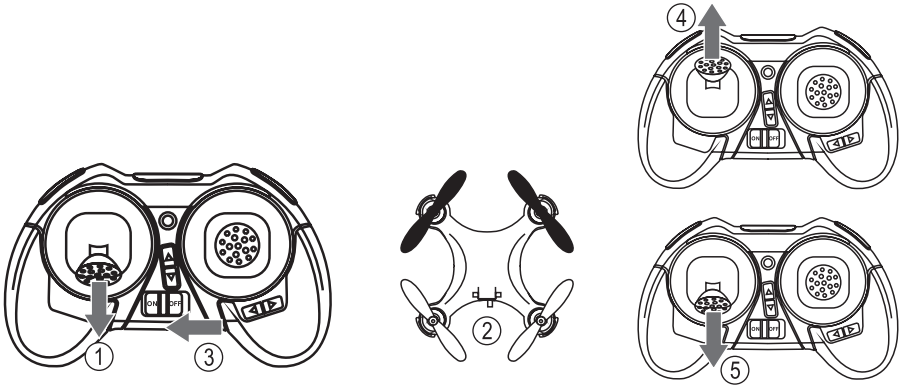

Figure 9

- Put the control stick for the motor control to the bottom position for this (1).
- Switch on the quadcopter (2). The front LEDs in the model start to flash quickly.
- Place the model on a level surface as smooth as possible (e.g. stone floor). A carpet is less suitable because the landing legs may be caught in the carpet easily. The front (black) rotors point forward (away from you).
- Switch on the remote control transmitter by pushing the on/off switch (3). The transmitter confirms this with a double signal sound. The control LED at the transmitter (fig. 3, item 2) will flash.
- Push the left control lever (4) forward until a control sound sounds.
- Pull the left control lever (5) backwards until a control sound sounds. The control LED at the transmitter and the LEDs at the quadcopter are now permanently lit.
- The quadcopter is now bound to the transmitter and ready to start.

- Start the rotors by slowly moving the left control stick forward. If you want to switch off the rotors again, pull the left control stick back again.
- Now increase the rotating speed of quadcopter rotors by pushing the left control lever forward slowly until the quadcopter takes off and hovers in front of you at a height of approx. 1.5 metres. Generally avoid any fast and big controlling motions. Also watch closely to see whether and in which direction the quadcopter moves. By using trimming on the remote control (see item c) in this chapter), you can avoid undesired movements.
- To land the quadcopter again, pull the left control lever back slightly in a suitable landing location until the quadcopter gravitates to the ground. A somewhat solid touchdown on the ground is no problem and should not be corrected with jerky throttle movements.
- Try to touch down where possible in vertical position ("helicopter landing"). Avoid landing with high horizontal speeds ("airplane landing"). After landing, turn off the motors (pull the left control stick back all the way).
- Practice this starting procedure a few times to get a feel for the quadcopter. Once you are reasonably sure, you can begin to steer the flight direction with yaw, nod and roll functions (see notes in chapter 11). Always steer slowly and carefully and practice the processes a little before trying a new flight manoeuvre. The first flights should not last longer than 30 to 60 seconds respectively.
- When you have familiarised yourself a little with the model's flight properties, you may perform additional exercises. Start with simple flight manoeuvres like a flying a meter forwards/back (nod function). Then practice hovering to the left/right (roll function). When you have the practice you need, start flying circles and figure eights.
- If you want to terminate flying, the rotors must be switched off first after landing. Then put the model's on/off switch to the "OFF" position. Only then must the transmitter be switched off.

b) Flight Movements

After the model has been started, it is in hover flight. Push the left control lever at the transmitter forward carefully. This initiates rising of the model. Put the left control stick roughly into the middle position again to stop rising. Pull the left control lever back carefully to start sinking.

If you move the left control lever to the left, the model will turn around its vertical axis. If you move it towards the right, the quadcopter will turn to the right.

Push the right control lever forward carefully. The model is controlled forward. If you push the right control lever backwards, the quadcopter will be controlled backwards.

If the right control lever is controlled to the left, the model will float to the left. If you move the right control lever to the right, the quadcopter will float to the right.

→ When controlling the model, also observe the notes in chapter 11.

c) Trimming

In the course of flight operation, it is possible the quadcopter will not hover in place but drift off in one direction (e.g. forward). In this case, the model must be returned to the condition where the quadcopter hovers in place by trimming.

Push the trimming buttons for the drift direction:

- The quadcopter drifts to the left = push the right trim button for the roll control function
Hold or push the trim button as long/as often as necessary to achieve a stable flight condition. Now push the button for the trim again to leave trimming mode.
- The quadcopter drifts to the front = push the rear trim button for the nod control function
Hold or push the trim button as long/as often as necessary to achieve a stable flight condition. Now push the button for the trim again to leave trimming mode.

→ If you keep a trim button pushed, the maximum trim path is reached more quickly. This is displayed by signals sounds. If you no longer hear any signal sound, the maximum trim path has been reached.

If you hear a slightly higher sound, the trim is set precisely to zero. Further trimming is interrupted here. Briefly release the trimming button and push it again to continue trimming of the model.

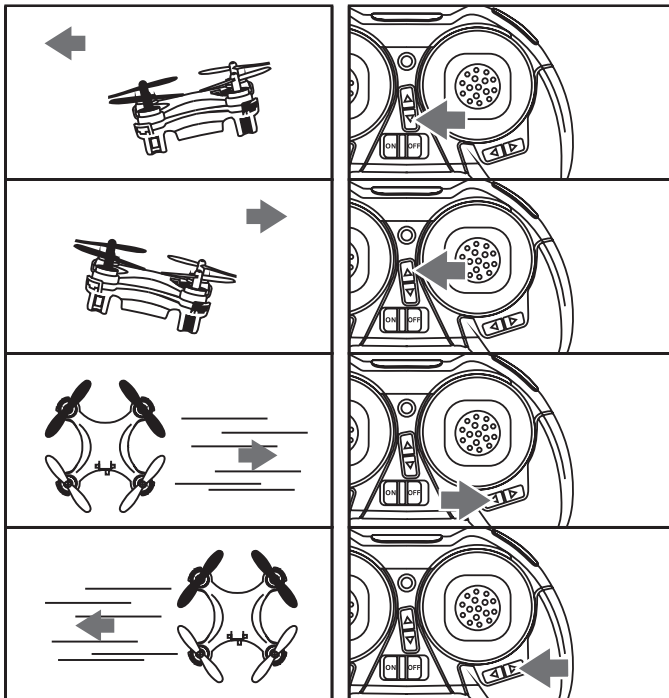

Figure 10

d) Flip Function

The model can perform a flip (a 360° turn). For this, put the quadcopter into a stable hover flight at an altitude of at least 1.5 metres at sufficient distance from the pilot and any obstacles.

Push the right control stick vertically down (push the control stick like a button).

The transmitter will emit a control sound at an even rhythm to confirm that you have chosen flip mode. The control sound will remain activated until the flip is completed.

Now, briefly put the right control lever in the direction in which the flip is to take place.

Examples: If you push the right lever forward, the quadcopter will turn over forwards. If you push the right lever backward, the quadcopter will turn over to the right.

After you have specified the flip direction at the transmitter, put the right control lever into the neutral position again at once.

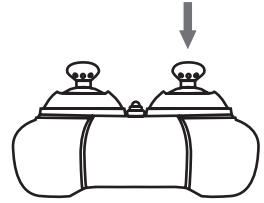

Figure 11



Attention!

The flip function generally must only be used if the model is flown in a large hall or outdoors, is in a stable flight condition (hovering) before the respective operating button is pushed at the transmitter, the flight height is not below 1.5 metres and the quadcopter is at least 5 metres away from obstacles and persons. If this is not observed, there is a danger of damage to the model or other objects nearby and a danger of injury to persons/animals in the vicinity from contact or crash! We recommend performing the first flips in the rising movement of the quadcopter.



When the model is already in "Low Batt mode" (front LEDs at the quadcopter flash), the flip function is deactivated for reasons of safety and therefore cannot be performed.

The model can perform a flip function only in one direction (only forward or backward; only to the left or right) and therefore also requires the corresponding clear control commands from the transmitter (right control lever forward or back; right control lever to the left or right). Therefore, avoid inadmissible control commands when the flip function is activated, such as "right control lever pushed to the front+left". In such cases, there may be uncontrolled flight conditions and crashes.

After a flip, the function is automatically deactivated at the transmitter. If you want to perform another flip, you need to activate the flip function at the transmitter first.

13. Maintenance and Repair

a) Regular Cleaning

The quadcopter "Q" is a very simply built flight model. There are no mechanical parts that need to be lubricated or require special maintenance. However, after each flight operation, you should clean the quadcopter of possible contamination (wool threads, hair, dust etc.).

For cleaning, use a dry or slightly damp cloth and avoid contact between water and the electronics, rechargeable battery and motors.

b) Replacing the Rotors

If a rotor is damaged in a crash or other action, replace it immediately. This also applies if there are any fine tears or grazing in the rotor. Due to the high speed, material parts could come loose if the rotors are damaged and this could lead to damage to or endangerment of the environment.

To replace a rotor, carefully lever the damaged rotor from the motor shaft with a suitable tool (e.g. flat-head screw-driver) and replace it by a new one. Installation must be performed with the necessary caution and the corresponding care.

For orientation, put the quadcopter onto your work surface so that the black rotors of the model point forward.

The front rotors (figure 12, items 1 and 2) must have black rotors. Rotor 1 turns clockwise, rotor 2 turns counter clockwise.

The rear rotors (figure 12, items 3 and 4) must have white rotors. Rotor 3 turns counter clockwise, rotor 4 turns clockwise.

Do not bend the drive shafts. Bent shafts (e.g. from crashes) influence the flight properties negatively due to the vibration that results and the irritation to the sensors. Motors with bent shaft must be replaced.

The rotating direction is marked at the bottom of the rotors ("A" or "B").

The rotors marked "A" must be installed on the rotors that turn to the left (counter clockwise).

The rotors marked "B" must be installed on the rotors that turn to the right (clockwise).

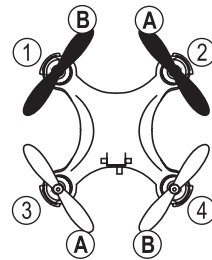

Figure 12



Attention!

Please observe the rotating direction of the respective motor and the choice of the corresponding rotor without fail. If these are incorrectly chosen, the model will not be able to fly and will act in an erratic way when next started! Loss of guarantee/warranty!

c) Calibration

The quadcopter "Q" is delivered calibrated perfectly ex works. After harder landings or crashes, it is possible that the quadcopter will no longer fly as usual. In this case, you should recalibrate the quadcopter.

For this, put the quadcopter onto a level surface ready to start. Select professional mode by pushing the left control stick several times until you can hear three control sounds.

First put the left control stick in the left/bottom position. Hold the control lever in this position.

Then put the right control stick in the left/upper position and hold it there.

The front LEDs flash several times in sequence. Once these LEDs are lit permanently, calibration is completed successfully and you can release the control lever again.

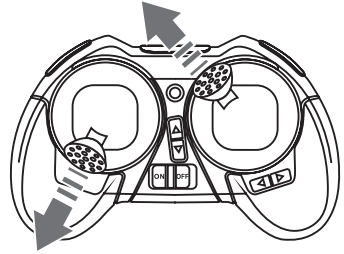

Figure 13

14. Disposal

a) Product



Electronic devices are recyclable and should not be disposed of in household waste. Dispose of the product according to the applicable statutory provisions at the end of its service life.



Remove any inserted batteries/rechargeable batteries and dispose of them separately from the product.

b) Batteries/Rechargeable Batteries

You as the end user are required by law (Battery Ordinance) to return all used batteries/rechargeable batteries. Disposing of them in the household waste is prohibited.



Batteries/rechargeable batteries that contain hazardous substances are labelled with the adjacent icon to indicate that disposal in domestic waste is forbidden. The descriptions for the respective heavy metals are: Cd=cadmium, Hg=mercury, Pb=lead (the names are indicated on the battery/rechargeable battery e.g. below the rubbish bin symbol shown on the left).

You may return used batteries/rechargeable batteries free of charge at the official collection points in your community, in our stores, or wherever batteries/rechargeable batteries are sold.

You thus fulfil your statutory obligations and contribute to the protection of the environment.

15. Declaration of Conformity (DOC)

Conrad Electronic SE, Klaus-Conrad-Straße 1, D-92240 Hirschau, hereby declares that this product complies with directive 2014/53/EU.

→ The complete text of the EU declaration of conformity is available under the following web address:

www.conrad.com/downloads

Choose a language by clicking a flag symbol and enter the item number of the product into the search field; then you may download the EU declaration of conformity in the PDF format.

16. Technical Data

a) Transmitter

Transmission frequency.....2.4 GHz
Transmission output2 mW (3 dBm)
Transmitter rangemax. 20 - 25 m (free field)
Operating voltage3 V/DC (2 type micro/AAA batteries)
Dimensions (W x L x H).....50 x 96 x 60 mm
Weight (without batteries).....approx. 50 g

b) Quadrocopter

Total height20 mm
Diameter42 mm
Diameter of the rotors.....30 mm
Take-off weightapprox. 12 g
Permissible flight operationin buildings and in wind still conditions
Permitted temperature range.....0 °C to +40 °C
Permitted humidity.....max. 75% rel. humidity, non-condensing

c) USB Charger

Operating voltage5 V/DC (via USB)
Required input current.....min. 500 mA
Charge end voltage4.2 V (LiPo 1S)
Charge timeapprox. 30 minutes

GB This is a publication by Conrad Electronic SE, Klaus-Conrad-Str. 1, D-92240 Hirschau (www.conrad.com).

All rights including translation reserved. Reproduction by any method, e.g. photocopy, microfilming, or the capture in electronic data processing systems require the prior written approval by the editor. Reprinting, also in part, is prohibited. This publication represent the technical status at the time of printing.

Copyright 2017 by Conrad Electronic SE.