



TECHNOLOGY DATA SHEET & SPECIFICATIONS

MODEL: 0603B2C-KPC-B

Features

- Package in 8mm tape on 7" diameter reel.
- Compatible with automatic placement equipment.
- Compatible with infrared and vapor phase reflow solder process.
- Mono-color type.
- Pb-free.
- The product itself will remain within ROHS complaint version.



Descriptions

- The 0603 SMD LED is much smaller than lead frame type components, thus enable smaller
- board size, higher packing density, reduced storage space and finally smaller equipment to be obtained.
- Besides, lightweight makes them ideal for miniature applications.etc

Usage Notes:

- Surge will damage the LED
- When using LED, it must use a protective resistor in series with DC current about 20mA

Applications

- Automotive: backlighting in dashboard and switch
- Telecommunication: indicator and backlighting in telephone and fax
- Flat backlight for LCD, switch and symbol
- General use

Device Selection Guide

LED Part No.	Chip		Lens Color
	Material	Emitted Color	
0603B2C-KPC-B	InGaN	Blue	Water clear



TECHNOLOGY DATA SHEET & SPECIFICATIONS

MODEL: 0603B2C-KPC-B

Package Dimensions

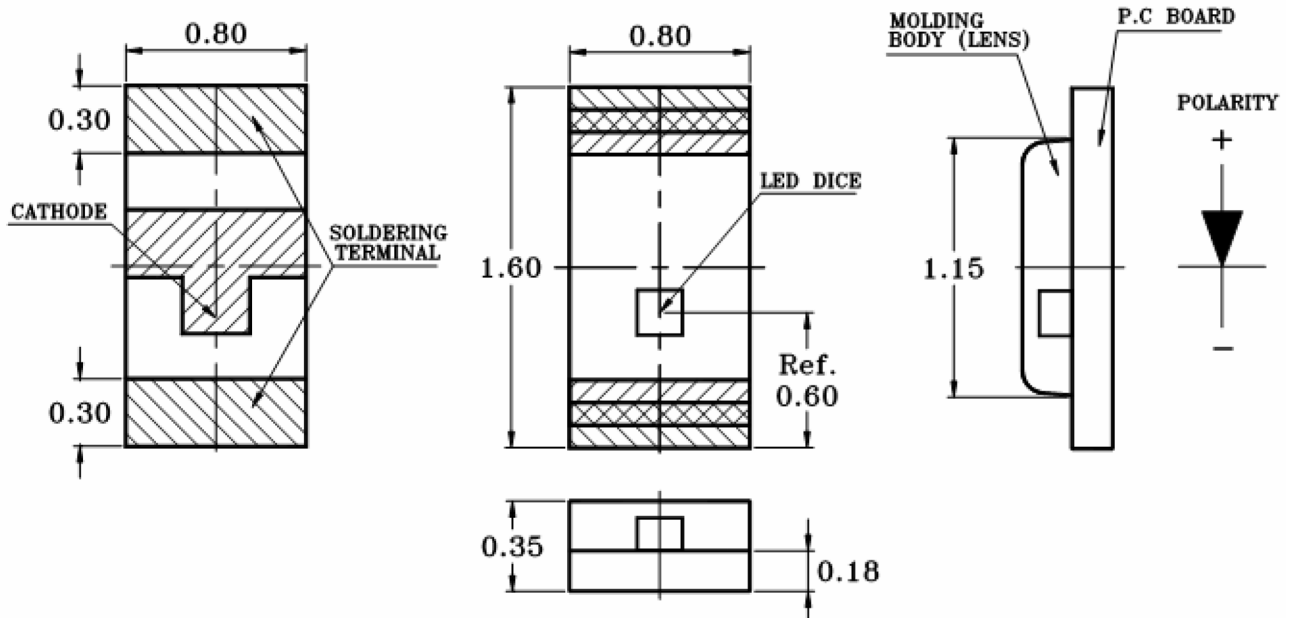

Notes:

1. All dimensions are in millimeters (inches).
2. Tolerance is ± 0.10 mm (.004") unless otherwise noted



TECHNOLOGY DATA SHEET & SPECIFICATIONS

MODEL: 0603B2C-KPC-B

Absolute Maximum Rating ($T_a=25^{\circ}\text{C}$)

Parameter	Symbol	Absolute Maximum Rating	Unit
Peak Forward Current (Duty 1/10 @1KHz)	I_{FP}	70	mA
Forward Current	I_{FM}	25	mA
Reverse Voltage	V_R	5	V
Power Dissipation	P_D	70	mW
Operating Temperature	T_{opr}	-55~+85	$^{\circ}\text{C}$
Storage Temperature	T_{stg}	-55~+85	$^{\circ}\text{C}$
Soldering Temperature	T_{sol}	Reflow Soldering : 260 $^{\circ}\text{C}$ for 5 sec. Hand Soldering : 300 $^{\circ}\text{C}$ for 3 sec.	

Electro-Optical Characteristics ($T_a=25^{\circ}\text{C}$)

Parameter	Symbol	Min.	Typ.	Max.	Unit	Test Condition
Luminous Intensity	I_v	80	---	150	mcd	IF=20mA(Note1)
Viewing Angle	$2\theta_{1/2}$	---	120	---	Deg	(Note 2)
Peak Emission Wavelength	λ_p	460	---	470	nm	IF=20mA
Spectral Line Half-Width	$\Delta\lambda$	---	65	---	nm	IF=20mA
Forward Voltage	V_F	2.9	---	3.5	V	IF=20mA
Reverse Current	I_R	---	---	10	μA	VR=5V

Note:

1. Luminous intensity is measured with a light sensor and filter combination that approximates the CIE eye-response curve.
2. $\theta_{1/2}$ is the off-axis angle at which the luminous intensity is half the axial luminous intensity.



TECHNOLOGY DATA SHEET & SPECIFICATIONS

MODEL: 0603B2C-KPC-B

Typical Electro-Optical Characteristics Curves

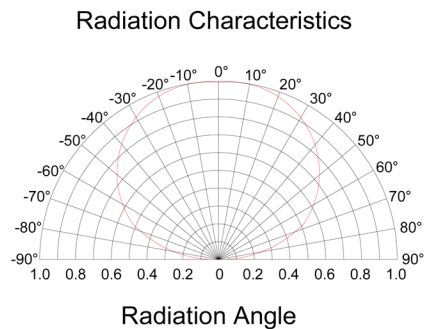
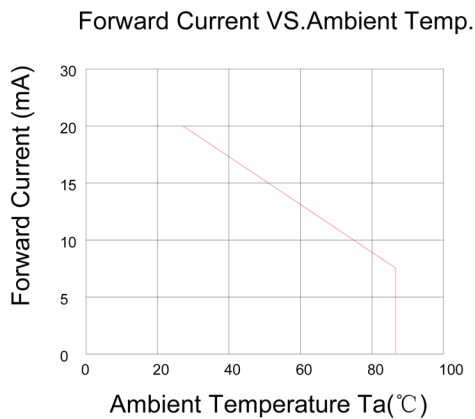
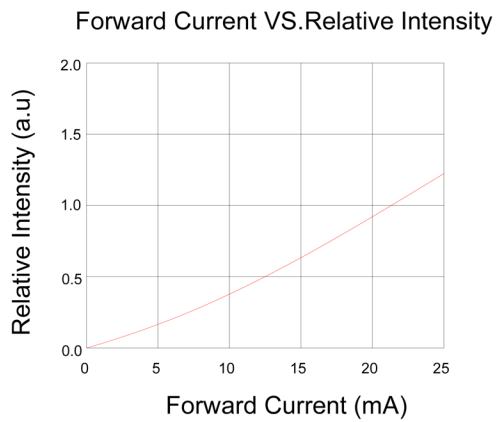
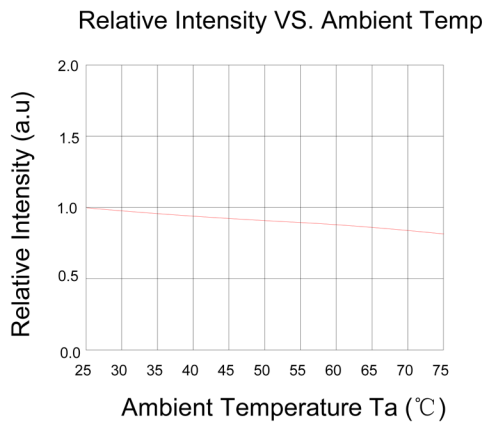
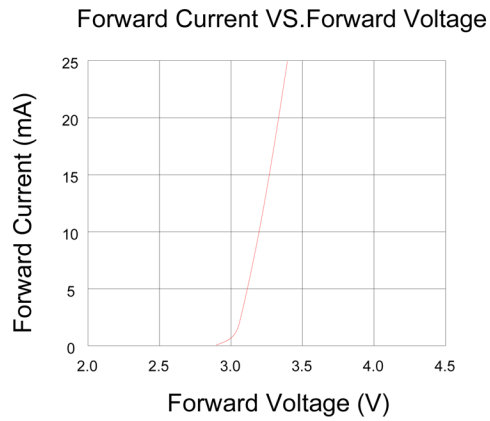
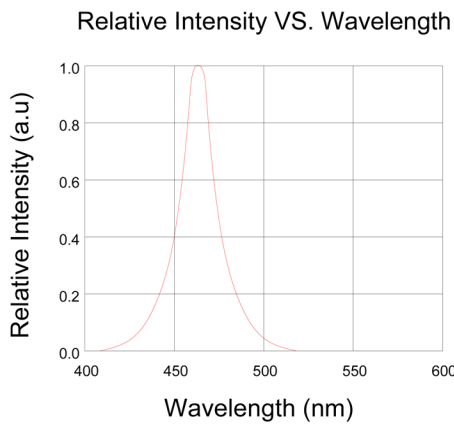



TECHNOLOGY DATA SHEET & SPECIFICATIONS

MODEL: 0603B2C-KPC-B

Precautions For Use

1. Over-current-proof

Customer must apply resistors for protection, otherwise slight voltage shift will cause big Current change(Burn out will happen)

2. Storage

Do not open moisture proof bag before the products are ready to use

Before opening the package, the LEDs should be kept at 30° C or less and 90% RH or less

The LEDs should be used within a year

After opening the package, the LEDs should be kept at 30° C or less 70% RH or less

The LEDs should be used within 168 hours(7 days)after opening the package

If the moisture absorbent material(silica gel)has faded away or the LEDs have exceeded the

Storage time, baking treatment should be performed using the following conditions

Baking treatment:60±5° C for 24 hours

3. Soldering Condition

Pb-free solder temperature profile

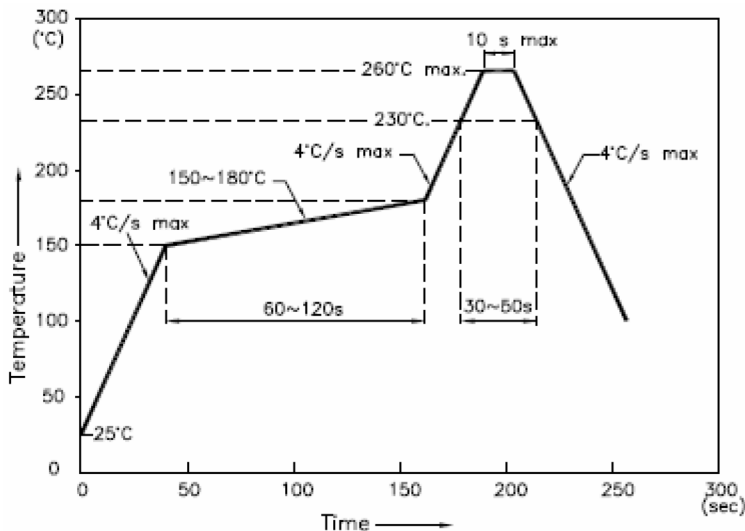

3.2 Reflow soldering should not be done more than two times

3.3 When soldering, do not put stress on the LEDs during heating

After soldering, do not warp the circuit board



HUIYUAN ELECTRONIC CO.,LTD.

TECHNOLOGY DATA SHEET & SPECIFICATIONS

MODEL: 0603B2C-KPC-B

4. Soldering Iron

Each terminal is to go to the tip of soldering iron temperature less than 280°C for 3 seconds within once in less than the soldering iron capacity 25W. Leave two seconds and more intervals, and do soldering of each terminal. Be careful because the damage of the product is often started at the time of the hand solder

5. Repairing

Repair should not be done after the LEDs have been soldered. When repairing is unavoidable, a double-head soldering iron should be used (as below figure). It should be confirmed beforehand whether the characteristics of the LEDs will or will not be damaged by repairing

