

Firmenanschrift aufbewahren - Nicht geeignet für Kinder unter 3 Jahren! - Verschluckbare Kleinteile! Keep the address of the company - Not suitable for children under 3 years! - Contains small parts! Veuillez conserver l'adresse - Ne convient pas pour les enfants de moins de trois ans! - Contient de petites pièces pouvant être absorbées! Adres bewaren - Niet geschikt voor kinderen beneden 3 jaar! - Kleine onderdelen Kunnen worden ingeslikt!

SOL-EXPERT group, C.Repy - Mehlistrasse 19 - D-88255 Baidnt
Tel.: +49 (0)7502 - 94115-0 - Fax: +49 (0)7502 - 94115-99
info@sol-expert-group.de - www.sol-expert-group.de

MADE IN GERMANY



Return the device to a certified provider at the end of its useful life!



No. 78669



Parts list

Qty.	Component	Value
1	Wooden parts kit	Multiple parts
1	Glue with sandpaper	20 grams
1	Circuit board	50 x 36 mm
1	Resistor	680 kOhm
1	Diode	1N4001
2	Capacitor	150 nF
1	Capacitor	220 nF
1	IC socket	16 pole
1	Potentiometer	220 kOhm
6	Capacitor	100 uF
1	IC	TEA 2025
2	Red cable	15 cm
2	Black cable	15 cm
4	Screws M4 x 10	M4
4	Nut M4	M4
1	Loudspeaker	5 Watt / 8 Ohm
2	Screws M2 x 10	M2
2	Nut M2	M2
1	Switch	Commutator
1	Cable with cinch connector	approx. 45 cm
1	Cable tie	black
1	Battery clip	for 9 V block
8	Wooden screw	2 x 12
1	Battery	9 volt block 6F22

Active speakers for smartphones and MP3 players, soldering kit

We recommend:
adult supervision during assembly and soldering!



HINWEIS - NOTE - REMARQUE - LET OP!

(DT) Eine ausführliche Anleitung in deutscher Sprache liegt der Verpackung bei. Die Anleitungen in den Sprachen Englisch, Französisch und Niederländisch können kostenlos in unserem Shop heruntergeladen werden.

(EN) Instructions in German are enclosed in the packaging.

The instructions in English, French or Dutch can be downloaded in our shop for free. (FR) Des instructions en allemand sont fournies avec l'emballage.

Les instructions en anglais, français, et néerlandais sont à télécharger gratuitement dans notre boutique. (NL) De Duitse handleiding is bij de verpakking inbegrepen. De handleidingen voor de talen Engels, Frans en Nederlands kunnen gratis in onze shop worden gedownload.

www.sol-expert-group.de

You will need:

Soldering iron, solder, tweezers, small screwdriver, side cutters, small phillips screwdriver, hammer

The active speaker for smartphones and MP3 players

General: This soldering kit is intended as a simple introduction to the basics of soldering. It is ideal for guided soldering courses in school and workshops. The active speakers can further be used in holiday programmes, school camps and other events related to soldering.

The function of the active speaker for smartphones and MP3 players

This soldering kit contains all parts necessary to make a fully functional active speaker for mobile phones and MP3 players, with a stylish wooden case. Soldering and glueing are the most important aspects of the task. And thanks to the wonderful step-by-step instructions, this project will also be a success. The reward: take away a wonderful sound (battery operated). Open your music app, connect the speaker, turn it on, and you are off! The battery is included in delivery.

Safety Notes

- Keep these instructions in a safe place for future reference! They contain important information.
- If the storage battery is flat, only replace it with a new battery with the same specifications. (9 V block 6F22)
- This kit is only intended for battery operation.
- The soldering iron, the solder and the components being soldered become very hot during soldering. Be very careful!
- Always use a soldering base when soldering! This will prevent the components and the board from slipping.
- We recommend a soldering iron stand to hold the soldering iron safely during assembly.
- **Never connect the kit to 230 V mains voltage! Acute danger to life!**

Environmental Warnings

General: Please return the circuit board to a certified disposal company at the end of its useful life. They will ensure the circuit board is disposed of in accordance with the law. This is environmentally friendly and actively contributes to the protection of the environment.

Battery Ordinance: You have purchased a battery-operated product from us. Used batteries must not be discarded in the household waste. Consumers are legally obligated to return batteries to a suitable collection site. Used batteries contain valuable raw materials which are recyclable. You may also send your batteries to: SOL-EXPERT group, Mehlistrasse 19, 88225 Baidnt.



ATTENTION:

The end user of this product is required by law to recycle the storage battery in this product!

1 Construction of battery compartment

A

Wooden parts on circuit board

B

Wooden parts on circuit board

C

D

2 Construction of circuit board compartment

A

B

C

D

3 Construction of speaker case



Sort and lay out parts:

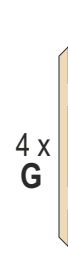
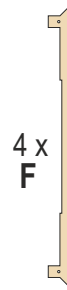
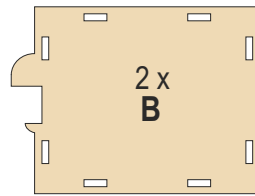
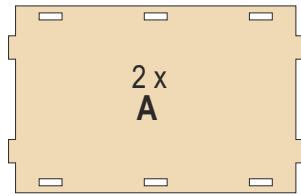

A

Mount this part twice:

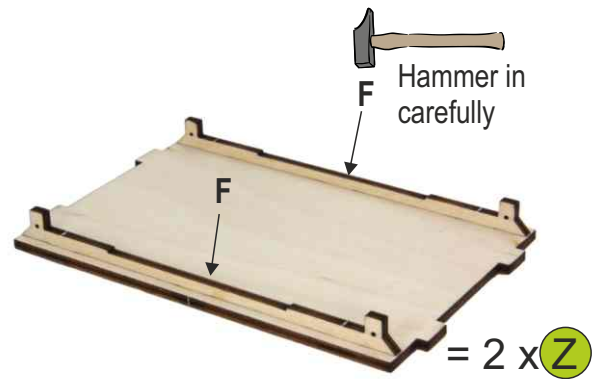
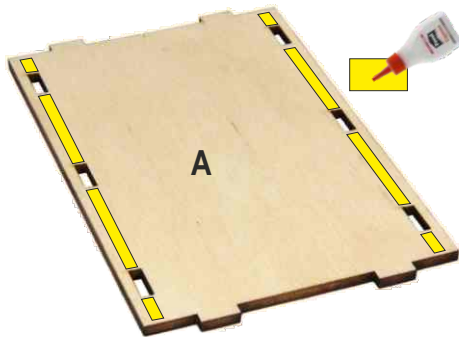

B

Attention: ensure they are correctly aligned!

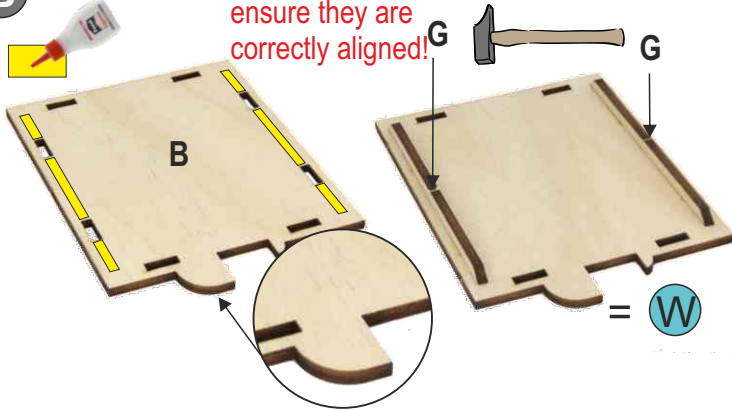

C

Attention: ensure they are correctly aligned!
Mirror image assembly!

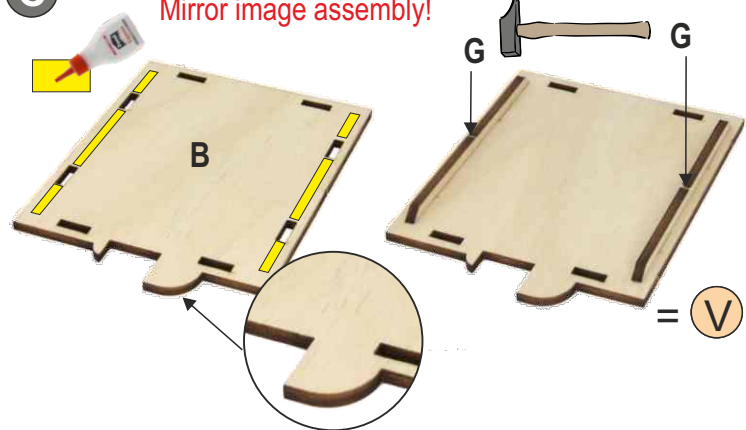

D

Z

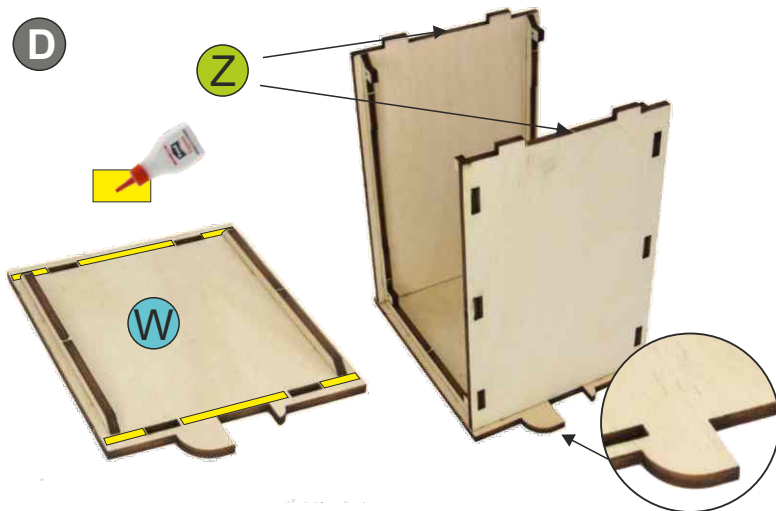

E

Attention: ensure they are correctly aligned!

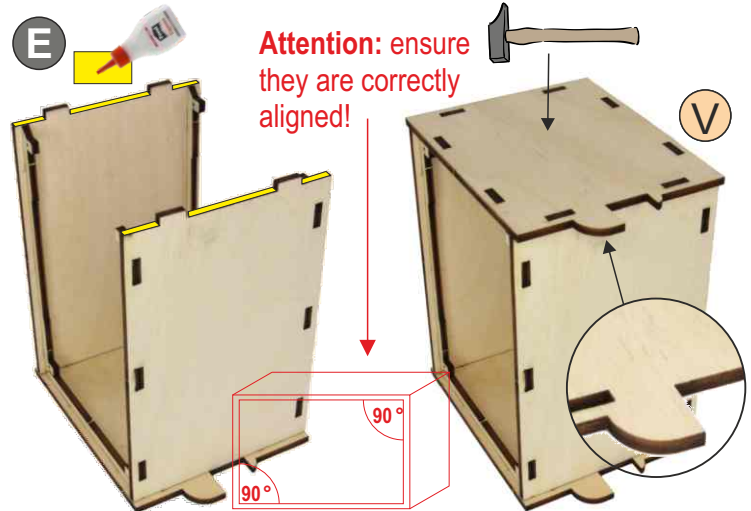

F

Place the circuit board and battery compartments in the glue and push them forwards until they touch the end.

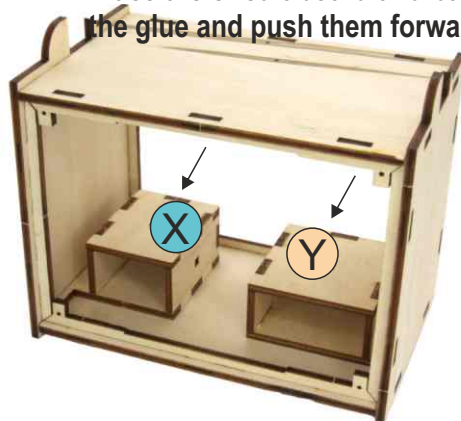
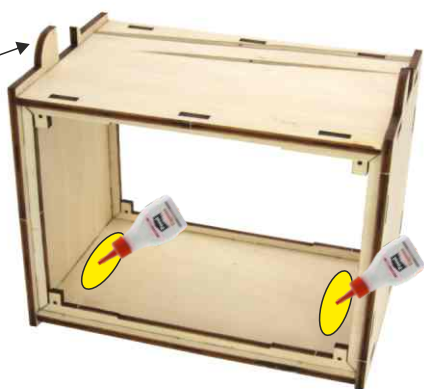
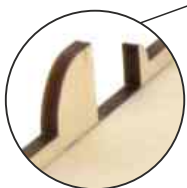

Leave to dry for 15 minutes!



A 4 Construction of circuit board

Sort and lay out all parts:

Part	Description
1	Circuit board
1	Resistor 680kOhm
1	Diode 1N4001
2	Capacitor 150 nF
1	Capacitor 220 nF
1	IC Socket
1	Potentiometer 220 kOhm
6	Capacitor 100 uF
1	IC TEA 2025
1	Red cable
1	Black cable

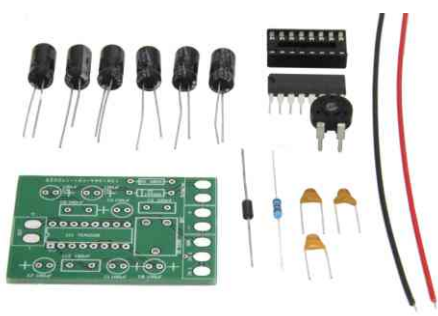

B Bend the resistor just enough so that it can be passed through the soldering lands.

Resistor 680 kOhm

With the resistor, you don't have to pay attention to the polarity.

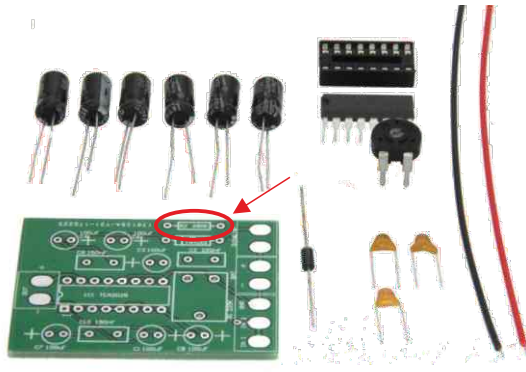

C Push the resistor leads through the circuit board (from the labeled side)

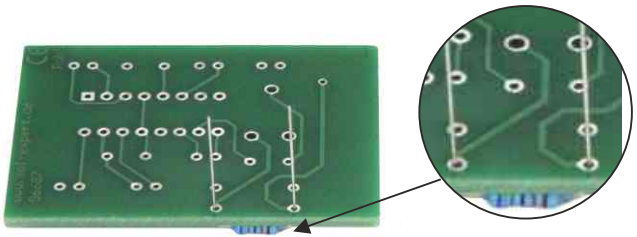

D Solder the resistor leads and shorten protruding wires to a length of approx 1mm above the solder point using side cutters.

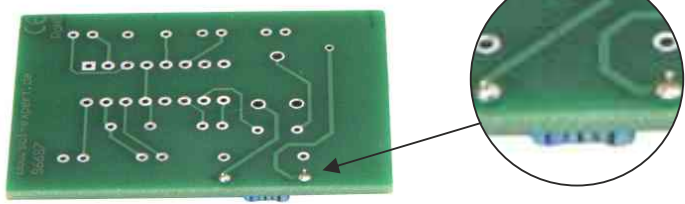

! If the length of the wires exceeds 1 mm, problems may arise when assembling the circuit board.

E Solder on the diode and shorten the protruding wires to 1 mm.

With the diode you have to pay attention to the polarity!
Attention:
white ring to the left side!

Diode 1N4001

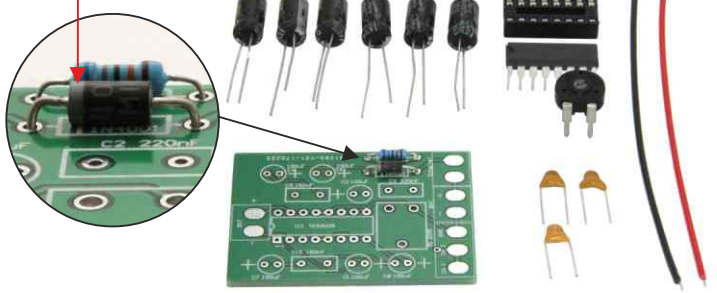

F Solder 150 nF capacitors and shorten protruding wires to 1 mm.

Capacitor 150 nF

2 x 154

154

Ensure that you have the correct value!

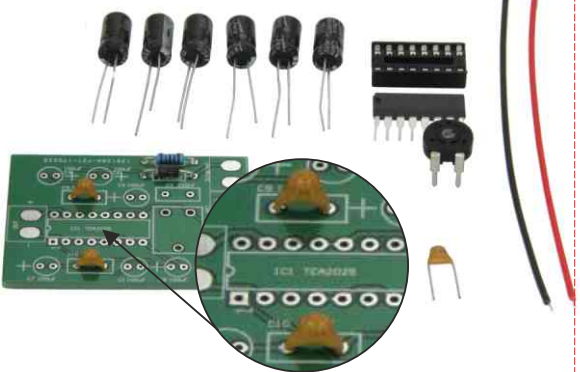

With these capacitors you do not have to pay attention to polarity.

G Solder on 220 nF capacitor and trim protruding wires.

Capacitor 220 nF

224

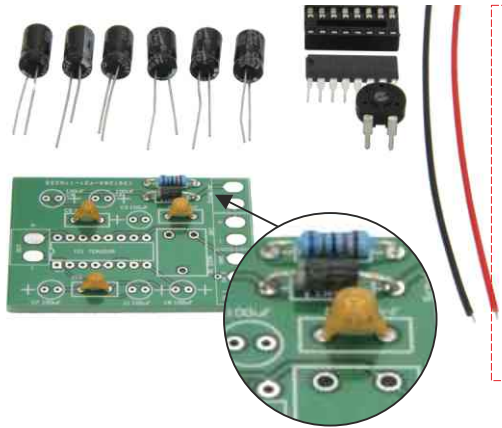

With this capacitor you do not have to pay attention to polarity.

H Solder on IC socket. Shorten protruding wires to 1 mm. With the IC socket pay attention to polarity!

IC socket

indent on the left hand side

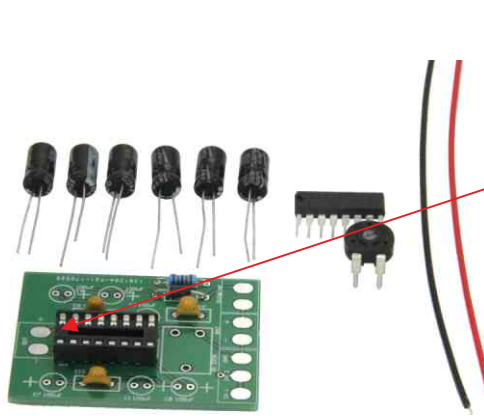

I Solder on potentiometer (Pot) and shorten protruding wires to 1 mm.

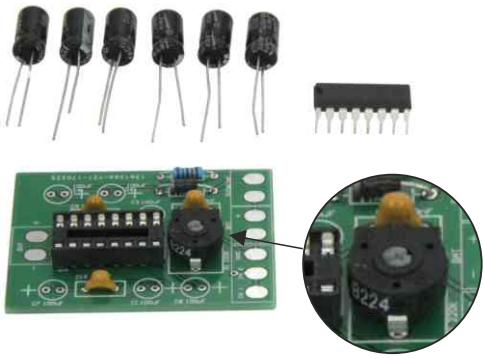

Pot 220 kOhm

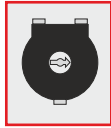

J Solder in capacitors and shorten protruding wires to 1 mm.

Pay attention to the polarity!

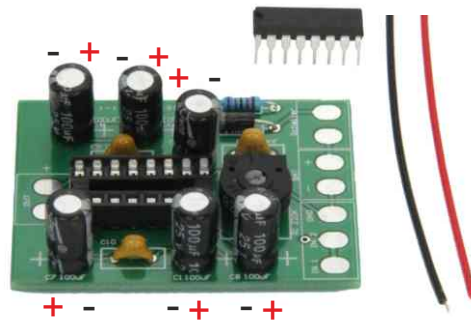

Capacitor 100 uF

IMPORTANT!

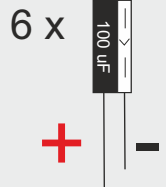

The longer pin is "+"

K Plug IC into socket; if necessary bend the feet slightly inwards. Pay attention to the polarity!



IC TEA 2025

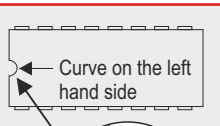

L Apply a little solder to the 2 contacts. (Pretinning)

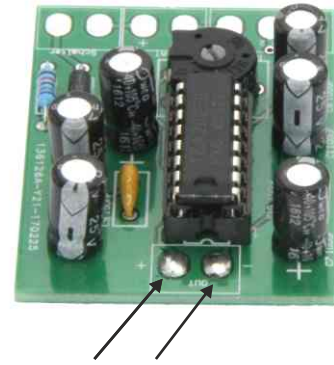

M Solder the red and black cables (both 15cm) to the solder pad.

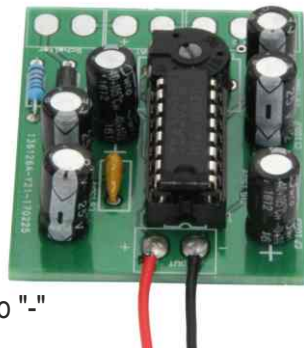

Red to "+" and black to "-"

N Apply a little solder to the 7 contacts. (Pretinning)

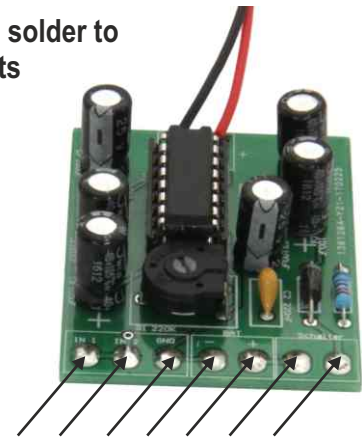

5 Construction of case front

Lay out parts

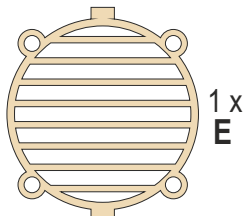
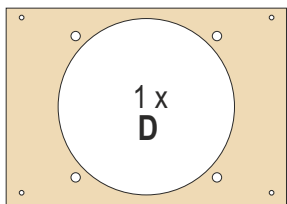

A Install 4 M4 x 10mm screws to the front of the speaker

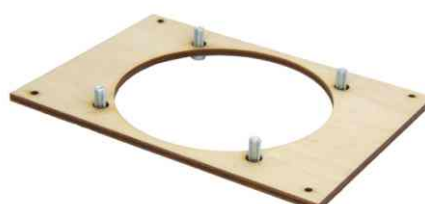

B Install speaker



C Secure and screw in with 4 x M4 nuts

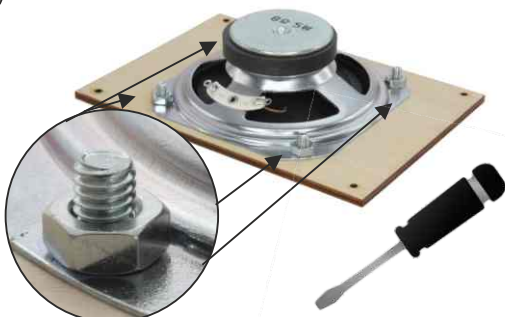

D Turn over



E Affix the protective grating (can also be glued)



6 Construction of case back

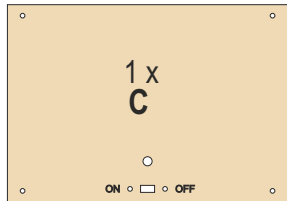

Inscription "ON - OFF" should be at the bottom

A Push 2 M2 x 10 mm screws through the back piece

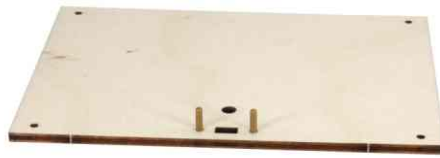

B Mount switch



C Secure and screw in with 2 M2 nuts

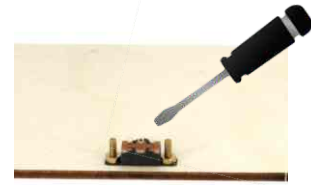

D Push cables (red and black) into the centre and right soldering eyes.

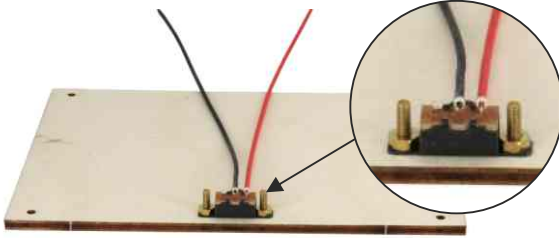

E Solder the cables to the eyes

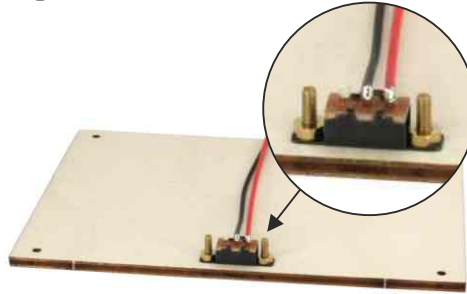

F View from the side

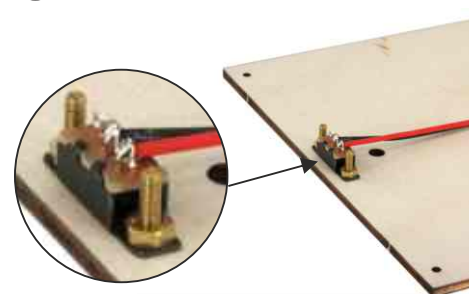

7 Cabling the case

A Pass the connection cable through the whole on the back, until the part of the cable that is inside measures approx. 10cm

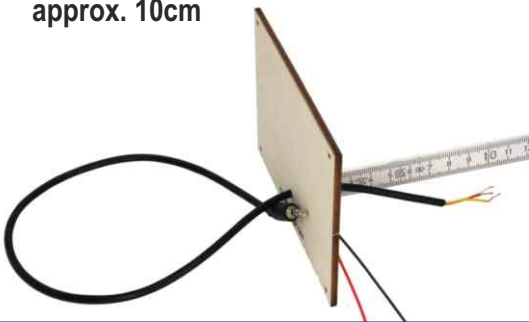

B Put a cable tie around the cable, and pull it very tight (tension relief). Cut off the remaining cable with side cutters.

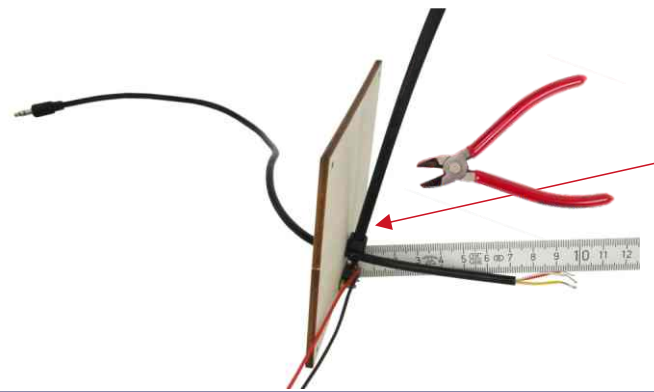

C Solder cable wires individually to the circuit board. Pay attention to the colours of the cables. Begin with the red wire, then the white, then the yellow.

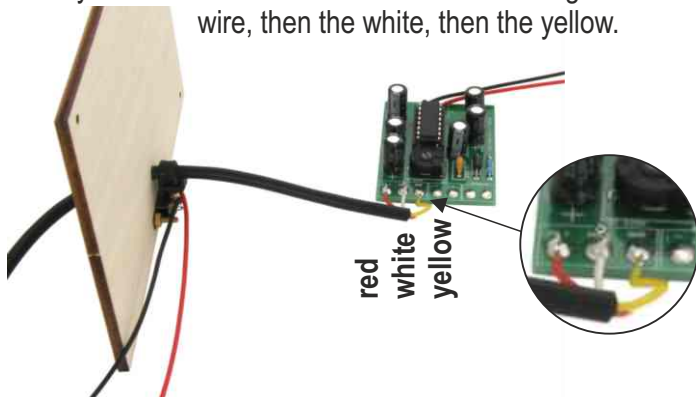

D Solder the battery clip cable to the circuit board. Pay attention to the colours of the cables!

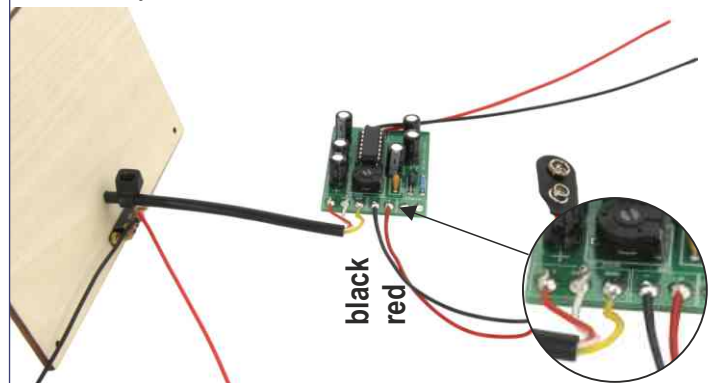

E Solder the switch cable on to the circuit board.

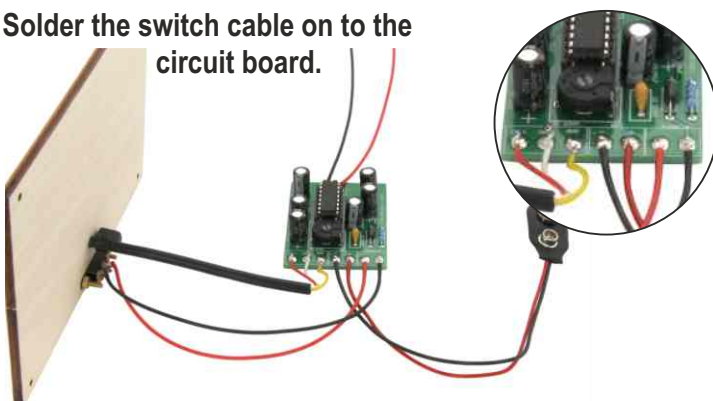

F Thread the speaker cables through the circuit board compartment

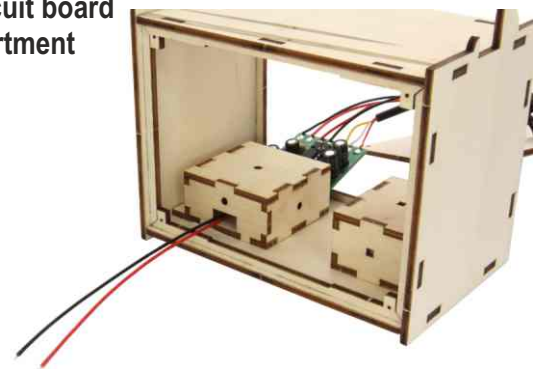

G Solder the speaker cable to the speaker contacts. Pay attention to polarity!
red = "+",
black = "-"

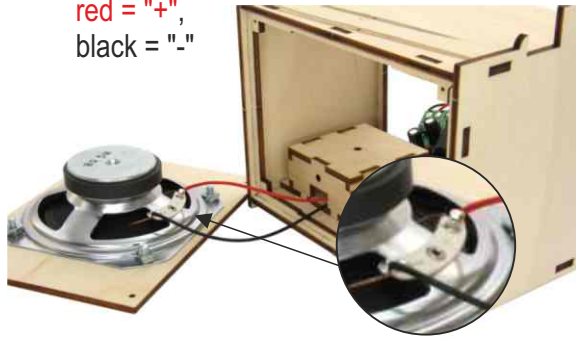

H Fasten front with 4 (2 x 20mm) screws. Speaker soldering eyes face upwards. See internal view!



8 Fine-tuning the speaker

- 1 Turn the switch on the back to "off"
- 2 Connect the battery with the battery clip
- 3 Plug the plug into your mobile phone's or MP3 player's headphone jack
- 4 Use the screw driver to turn the pot in an **anticlockwise** direction until it won't turn anymore (see fig.)

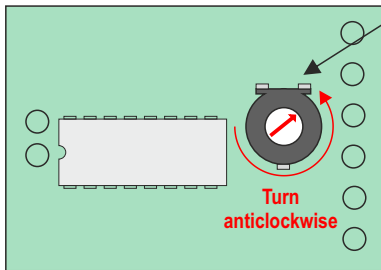

- 5 Open a music app, and turn the volume on your device to maximum
- 6 Now turn the switch to "ON"
- 7 Now turn the pot clockwise very slowly. As soon as the box begins to rattle because the volume is too high, turn the pot back a little, until you get a clearer tone. Now the active amplifier is properly installed

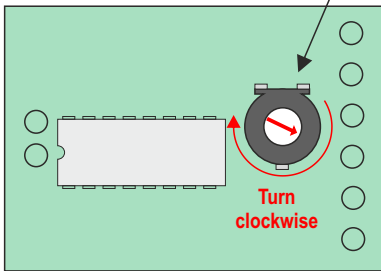

- 8 Now turn the active speaker off again, by moving the switch to OFF.

ONE - TWO - THREE CHECK

Now it is getting exciting!!
Put a tick in each box when
the stage is complete!

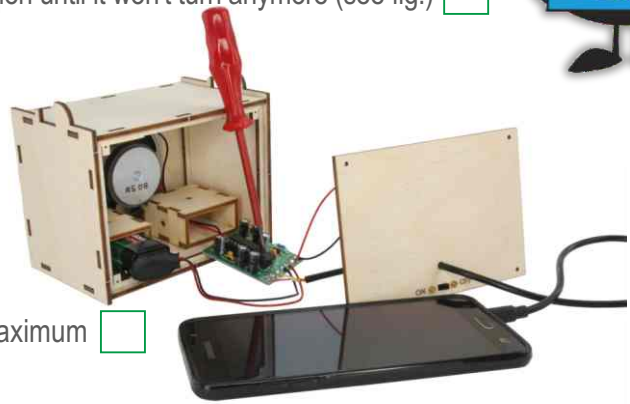

9 Final assembly of speaker

- A** Push the circuit board and the battery into the holders.

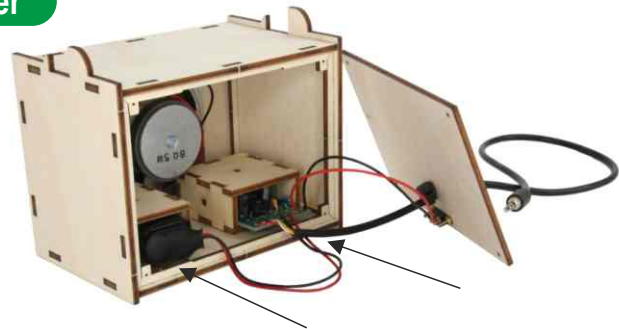

- B** Close back and fasten with 4 screws (2 x 10mm).



- C** **And now:** connect phone, open music app and turn on speaker - done!!

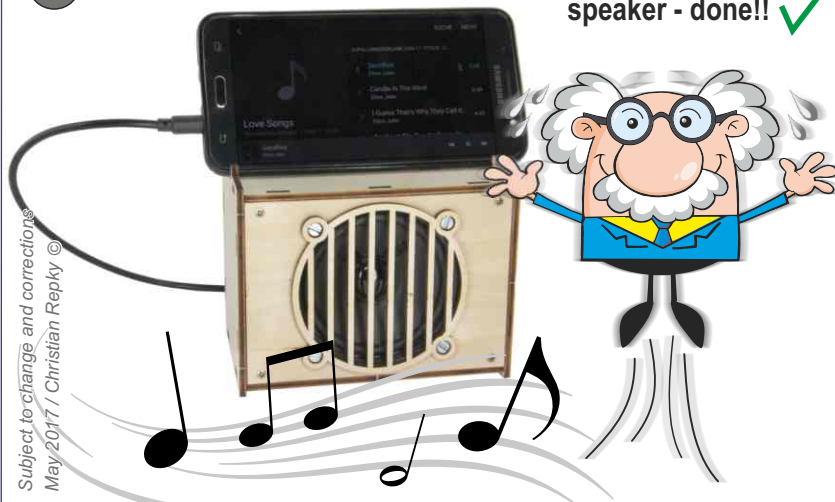

Always turn the speaker off when you are not using it, otherwise the battery will go flat. When this eventually happens, unscrew the back, change the battery, and screw the back on again.