

# Technaxx® \* User Manual Easy IP-Cam HD wireless TX-55

## Security Camera HD powered by batteries for indoor and outdoor use

The manufacturer Technaxx Deutschland GmbH & Co.KG hereby declares that this device, to which this user manual belongs, complies with the essential requirements of the standards referred to the Directive **R&TTE 2014/53/EU**. The Declaration of Conformity you find here: [www.technaxx.de/](http://www.technaxx.de/) (in bar at the bottom "Konformitätserklärung"). Before using the device the first time, read the user manual carefully.

**Service phone No. for technical support: 01805 012643** (14 cent/minute from German fixed-line and 42 cent/minute from mobile networks). Free Email: [support@technaxx.de](mailto:support@technaxx.de)

**If you drill a hole in the wall**, please make sure that power cables, electrical cords and/or pipelines are not damaged. When using the supplied mounting material, we do not take the liability for a professional installation. You are entirely responsible to ensure that the mounting material is suitable for the particular masonry, and that the installation is done properly. When working at higher altitudes, there is danger of falling! Therefore, use suitable safeguards.

## Content

|                                                                                                                       |    |
|-----------------------------------------------------------------------------------------------------------------------|----|
| Introduction .....                                                                                                    | 0  |
| 1. Features .....                                                                                                     | 1  |
| 2. Technical specifications .....                                                                                     | 1  |
| 3. Product View.....                                                                                                  | 2  |
| 3.1 Front.....                                                                                                        | 2  |
| 3.2 Rear .....                                                                                                        | 2  |
| 4. Setup Device .....                                                                                                 | 2  |
| 4.1 Install Device.....                                                                                               | 2  |
| 4.2 Install Easy IP Battery APP .....                                                                                 | 3  |
| 4.3 Add Camera from AP Mode .....                                                                                     | 3  |
| 4.4 Delete Camera (  Delete) ..... | 6  |
| 4.5 Resetting the device.....                                                                                         | 6  |
| 4.6 MicroSD card and camera positioning .....                                                                         | 6  |
| 4.7 Mounting .....                                                                                                    | 6  |
| 5. Monitor Easy IP Battery Camera .....                                                                               | 7  |
| 5.1 Monitor Camera .....                                                                                              | 7  |
| 5.2 Monitor Event Detection.....                                                                                      | 8  |
| 5.3 Event record list (Camera Record Management).....                                                                 | 8  |
| 6. Settings.....                                                                                                      | 9  |
| 6.1 Camera Setup .....                                                                                                | 9  |
| 6.2 Camera setting.....                                                                                               | 10 |

# 1. Features

- Ideal for monitoring indoor & outdoor locations, like rooms, garage, garden & areas difficult to view
- No power connection required, working with batteries
- Standby time ~3–5 months (with 1–3 events/day)
- Push notification via the APP when motion is detected
- Video resolution HD 1280x720 (720P) @ 30fps max.
- 1MP CMOS image sensor
- IR LED for clear night shots
- Motion detection: PIR-Sensor ~5–6m, triggering time ~1–1.5 sec.
- Easy to attach via magnet, 3M adhesive stripe or screws
- Easy setup by QR code scanning at iOS & Android device
- Free iOS & Android APP for live monitoring playback
- Built-in microphone for audio recordings
- IPX4 protection class (splashproof)



# 2. Technical specifications

|                                           |                                                                                                                                                  |  |
|-------------------------------------------|--------------------------------------------------------------------------------------------------------------------------------------------------|--|
| Video resolution                          | HD 1280x720 (720P) @ 30fps max. for video and event recordings                                                                                   |  |
| Image sensor                              | 1/4" CMOS OV9712, 1 megapixel                                                                                                                    |  |
| Lens                                      | F/NO=2.4, f=2.45mm, 120° viewing angle, fixed focus                                                                                              |  |
| Depth of field                            | ~50cm to infinity                                                                                                                                |  |
| White balance / Exposure                  | Automatically                                                                                                                                    |  |
| WiFi / connection distance                | Built-in WiFi module IEEE 802.11b/g/n, ~20–30m distance                                                                                          |  |
| Audio encoder / Input                     | AAC & AC3 mono / sample rate 48K & built-in microphone                                                                                           |  |
| Video encoder / File format               | H.264 / MP4                                                                                                                                      |  |
| Picture resolution / Format               | 1280x800 / JPG                                                                                                                                   |  |
| Night vision                              | High power IR LED lights with removable IR filter                                                                                                |  |
| PIR detection range / PIR triggering time | ~5–6m / ~1–1.5 seconds                                                                                                                           |  |
| Storage                                   | MicroSD card* up to 32GB (*not included)                                                                                                         |  |
| Power                                     | 4x CR123A batteries** (**included)                                                                                                               |  |
| Weight / Dimensions                       | 150.5g (without batteries)<br>(L) 11.2 x (W) 6.5 x (H) 7.4cm (with stand)                                                                        |  |
| Package Contents                          | Easy IP-Cam HD wireless TX-55, Camera chassis, 4x screws & 3M adhesive stripe, Powerful magnet with iron plate, 4x CR123A batteries, User Manual |  |

Keep this manual for future reference or product sharing carefully. Do the same with the original accessorie(s) for this product. In case of warranty, please contact the dealer or the store where you bought this product

### 3. Product View

#### 3.1 Front

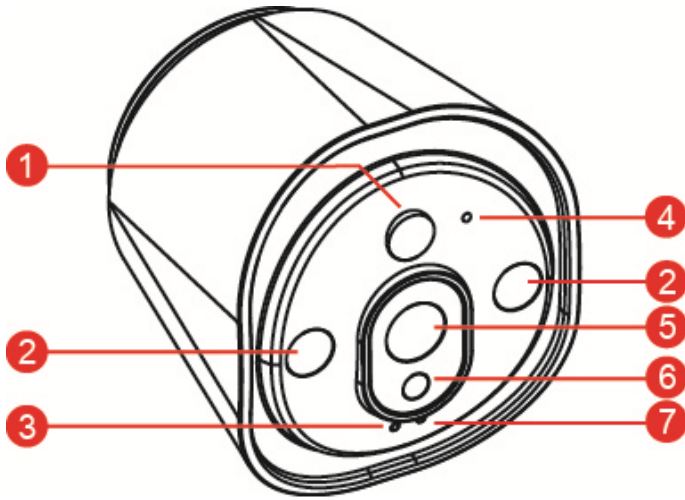

|   |              |
|---|--------------|
| 1 | PIR Sensor   |
| 2 | IR LED's     |
| 3 | Status LED   |
| 4 | Microphone   |
| 5 | Lens         |
| 6 | Light Sensor |
| 7 | Ready LED    |

#### 3.2 Rear

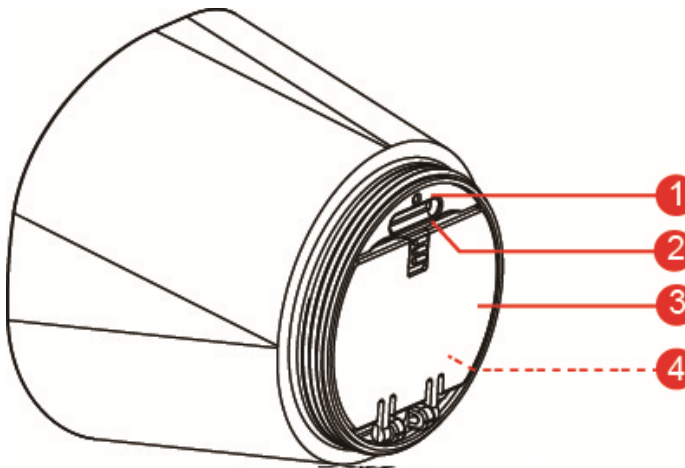

|   |                     |
|---|---------------------|
| 1 | Reset Button        |
| 2 | MicroSD Slot        |
| 3 | Battery Door        |
| 4 | Battery Compartment |

### 4. Setup Device

TX-55 has a built-in WiFi network and can connect to your WiFi router directly. Therefore, for the first time of TX-55 use, you need to set up the WiFi network and assign to an available network (WiFi router) which is linked to the internet.

#### 4.1 Install Device

To open the battery compartment turn right the magnet chassis of the camera, open the battery compartment and insert the included batteries. Make sure the battery polarities match the (+ and -) sign indicated in the battery compartment. Close the battery cover and the camera auto powers on. The RED Led of the camera is flashing slowly for about 3 seconds and turns off. After that the BLUE Led starts flashing slowly. Now the camera is in Access Point Mode (AP Mode).

## 4.2 Install Easy IP Battery APP

Search and find the Easy IP Battery APP from the APP Store for iOS or the Google Play Store for Android.

Then install it in your mobile device.

Press the Easy IP Battery icon to start it.





## 4.3 Add Camera from AP Mode

In the AP Mode, the Ready LED is flashing slowly in BLUE and the WiFi function is active.

### iOS configuration steps:

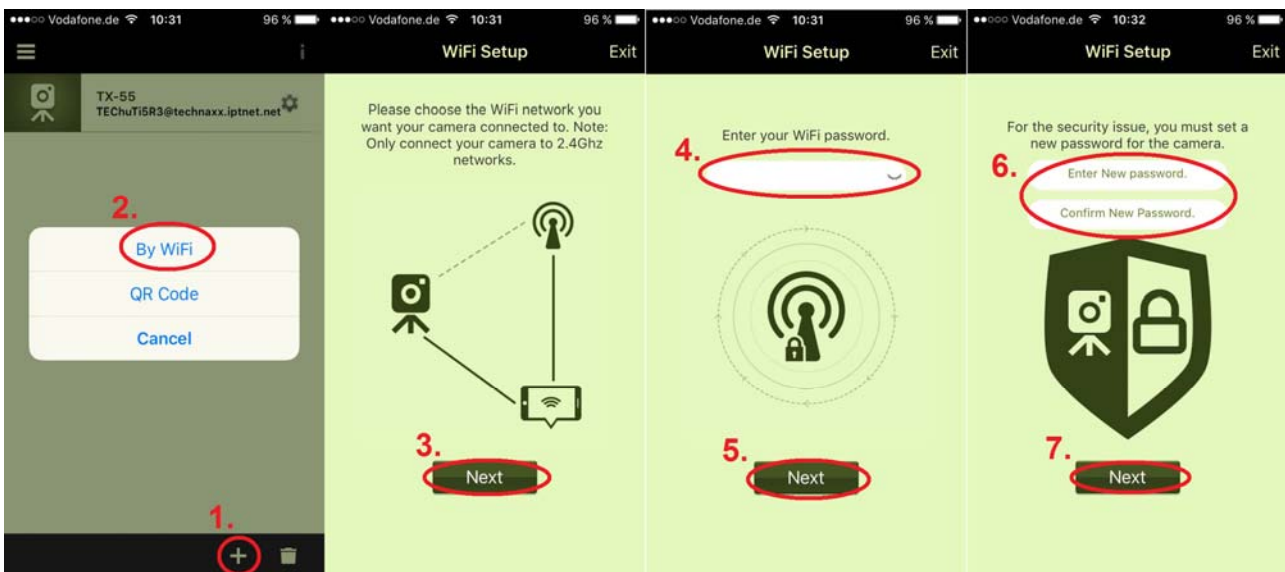
1. Press the add camera icon  from the APP to add camera.
2. Press WiFi Setup.
3. Press “Next”.
4. Enter the WiFi password of the router your Smartphone is connected to.
5. Press “Next”
6. Enter a new camera password (for safety use a password with min. 6 characters)
7. Press “Next”



8. Enter camera name. (Camera name can be customized like office, hall, garden, etc.)
9. Press “Next”
10. Press the **Home** button and go to the **WiFi** settings of the iPhone. Then select and connect with "**Device\_#####**", no need to enter password. Wait around 60 sec. and make sure you see  appear. Press **Home** button again and go back to **Easy IP Battery APP**.

- Press “Next” the device will be configured. After the TX-55 is set up, press “Finish” to complete. The Ready LED turns off and reboots the camera. Status LED flashing in Red within 10 sec. Then both the Ready and Status LED are on. If the configuration couldn’t finish press “Retry” or start the configuration again. The camera is ready for monitoring from your mobile device when camera is online.

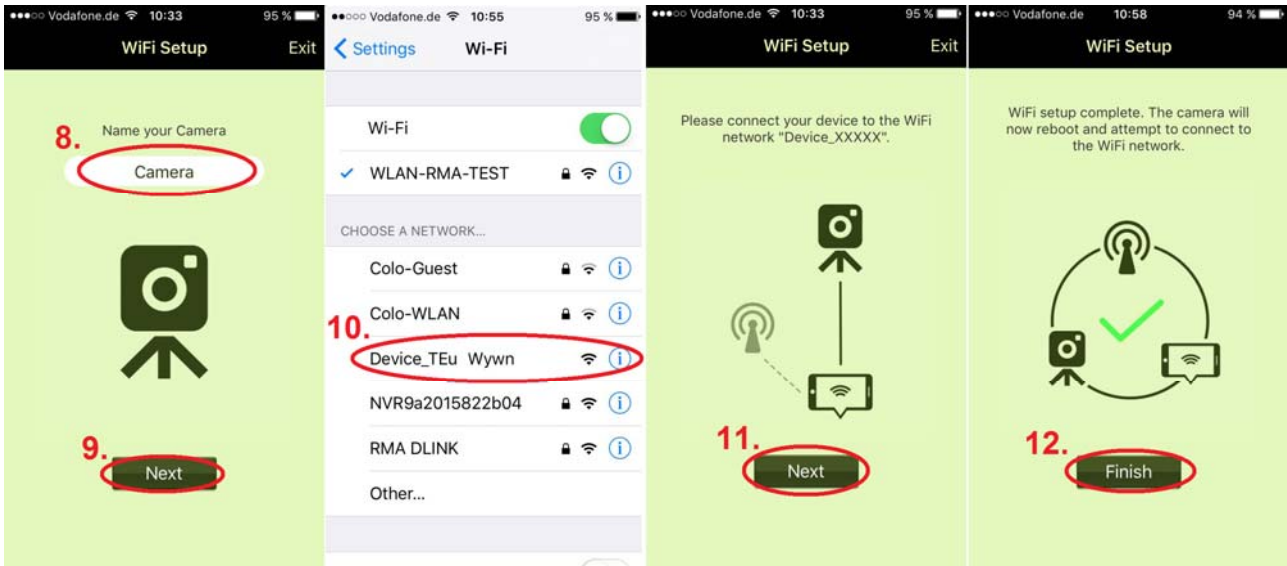

- Press “Finish”

**Android configuration steps:**

- Press the Add Camera icon **+** from the APP to add camera.
- Press the WiFi Setup.
- Select the WiFi network. Press scan to find different WiFi network in your surroundings. Default WiFi network is set as the network your Smartphone is connected with.
- Press “Next”.
- Enter the WiFi password of the router. You have selected.
- Press “Next”



7. The camera that should be connected will be found automatically. If you have more than one camera in your network you can select the device from the menu next to the device name or scan for devices with the button “Scan”.
8. Press “Next”
9. Enter a new camera password. (For safety use a password with minimum of 6 character)
10. Press “Next”

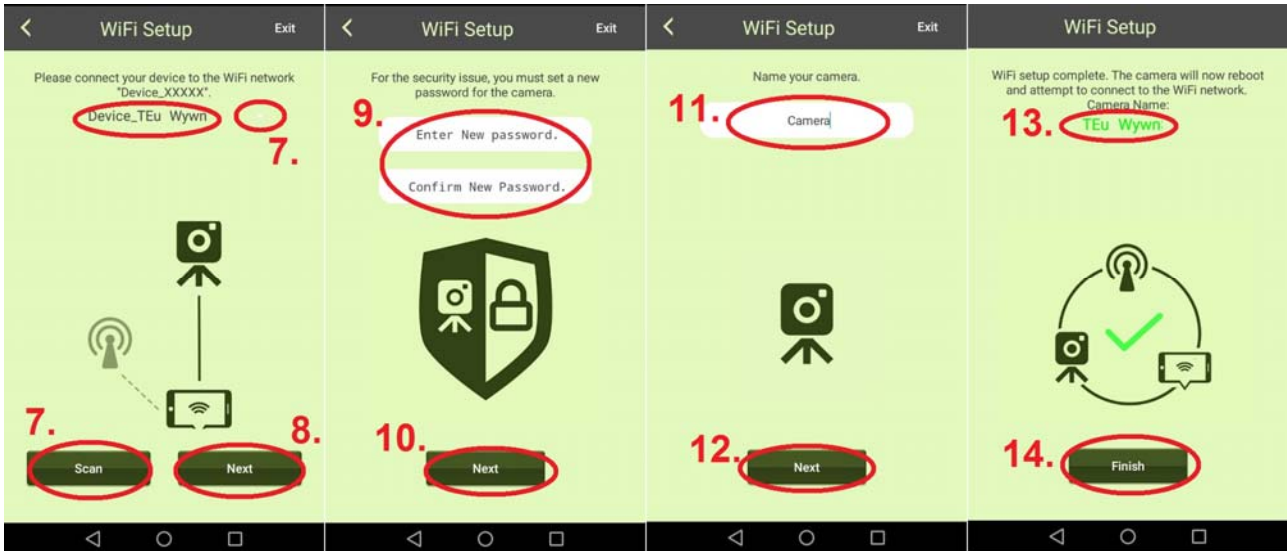

11. Enter camera name. (Camera name can be customized like office, hall, garden, etc.)
12. Press “Next”
13. Shows the device name that is going to be configured.
14. Press “Finish” the device will be configured. After the TX-55 is set up the Ready LED turns off and reboots the camera. Status LED flashing in Red within 10 sec. Then both the Ready and Status LED are on. If the configuration couldn't finished press “Retry” or start the configuration again. The camera is ready for monitoring from your mobile device when camera is online.

**Note:**

1. If the assigned WiFi network of the camera has changed, the camera must use the AP Mode to set the new assigned WiFi network again.
2. Make sure the assigned WiFi has enough bandwidth otherwise the camera is hard to reach or needs longer waiting time to access the internet.

#### 4.4 Delete Camera (🗑️ Delete)

Press the Delete Camera icon 🗑️ to delete camera. Select the camera to delete & press the 🎯 button.

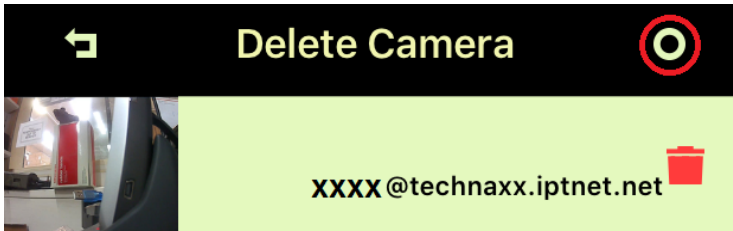

#### 4.5 Resetting the device

Push the Reset Button (~t 5 seconds and release it) to restore the default setting of camera in AP Mode. See chapter 3.2 for position of the Reset Button.

#### 4.6 MicroSD card and camera positioning

To insert a MicroSD card up to 32GB into the MicroSD slot turn right the magnet chassis of the camera. Put the magnet chassis back on.

#### 4.7 Mounting

**To mount the camera with the magnet on the metal base plate** which can be installed by drilling two holes and two screws on the wall. Also the camera can be mounted with its magnet mounting stand directly on a metal surface. Adjust the camera up or down to the applicable angle.

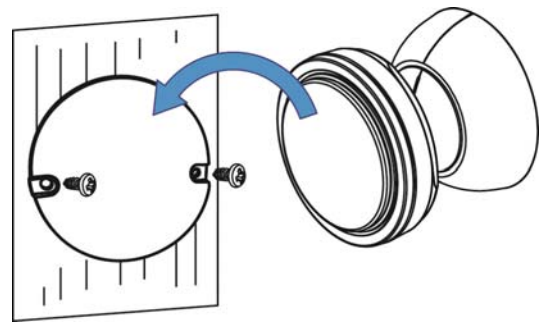

Metal plate for mounting    Magnet on camera stand

#### **Mounting place is not the iron and unsmooth (like Wood):**

Screw a supplied screw in the surface and retain a enough space out to hang the camera chassis. Hang the screw hole of the camera chassis on the screw.

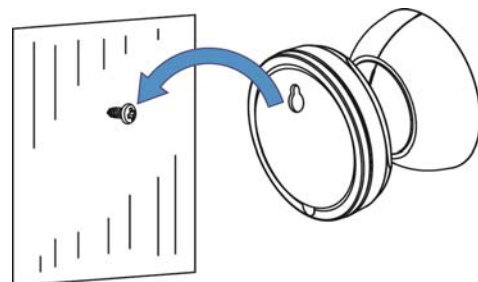

**For mounting with the 3M adhesive** first clean the magnet and the place you want to mount the camera with nail polish remover or alcohol. (**Warning!** Cleaning with alcohol or nail polish remover may damage the surface you are using.) Glue the 3M adhesive first to the magnet surface of the camera stand. The surface should be flat to maximize the surface between 3M adhesive and the surface of the mounting area. Adjust the camera up or down to the applicable angle.

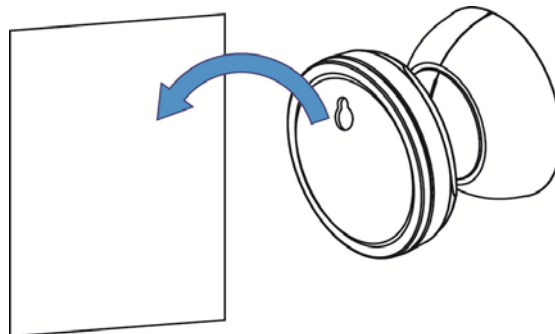

3M adhesive for the mounting stand of the camera

**Note:** Press and hold for 60 seconds to allow adhesive to bond to the surface. Bond strength will increase through time. At room temperature, wait for at least 24 hours to achieve 90% bonding strength, and 72 hours for 100% bonding strength.

## 5. Monitor Easy IP Battery Camera

### 5.1 Monitor Camera

Press the camera thumbnail to monitor live view image.

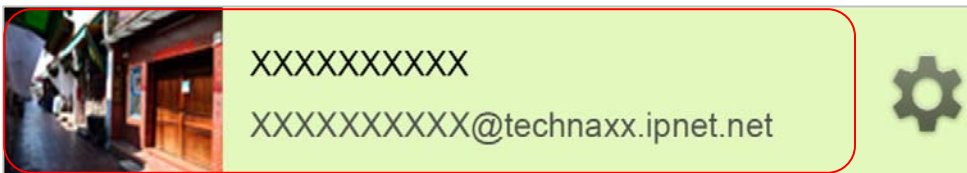

In the Live View screen, are 4 function buttons on the top left of the screen.

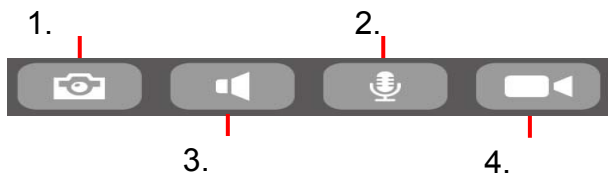

|    |                                                 |    |                                                                                                                |
|----|-------------------------------------------------|----|----------------------------------------------------------------------------------------------------------------|
| 1. | Snapshot: Get an instant picture                | 3. | Microphone: Voice transmission via the microphone of the mobile device and the built-in speaker of the camera. |
| 2. | Mute: Turn off the speaker of the mobile device | 4. | Record: Record an instant video clip                                                                           |



**Note:** 1. The Snapshot picture save in the mobile device under "local\internal storage\DCIM\Technaxx\TEdeviceID@technaxx.iptnet.net\Snapshot" for Android. (iOS will save under local media in the Easy IP Battery APP. From there you can download the snapshot to your device.)

2. The record video clip save in the mobile device under "local\internal storage\DCIM\Technaxx\TEdeviceID @technaxx.iptnet.net\Recording" for Android. (iOS will save under local media in the Easy IP Battery APP. From there you can download the record to your device.)

## 5.2 Monitor Event Detection

The camera has built-in a PIR Sensor (Passive Infrared Sensor) which can detect the infrared signal emitting from a moving object like human or maybe animal. The camera will auto record a 20 seconds (default) video clip when the PIR Sensor has detected a moving object. The Ready and Status LEDs light during the event video record and save file. The camera will send an instant message to all your mobile devices which are running the Easy IP Battery and the triggered device is connected to.

### **Note:**

1. Video file saves in the micro SD card of the Smart Cloud Camera under "X:\DCIM\MOT\_VIDEO" folder. Make sure the MicroSD card has inserted in the MicroSD card slot and has enough space to save video files.

2. Indicators of the camera turn-off in the monitor mode.

3. The Ready LED will flash fast when the battery power is very low. Replace 4 brand new, same brand and model batteries at same time ASAP.

4. The video resolution is 720p (1280x720) and the file name format is: **xxxxxxxxxx.MP4**.

5. The feature of built-in sensor and PIR sensor are not designed to be used for surveillance or security. No responsibility will be taken by our company with take the consequences resulting from to use these features.

## 5.3 Event record list (Camera Record Management)

One click on the shortcut  on the main page, you directly get to Camera Record Management. You can view the from PIR sensor triggered videos here, which are stored on the MicroSD card of the camera.

## 6. Settings

### 6.1 Camera Setup

At the main page press the button  and change to the next page.

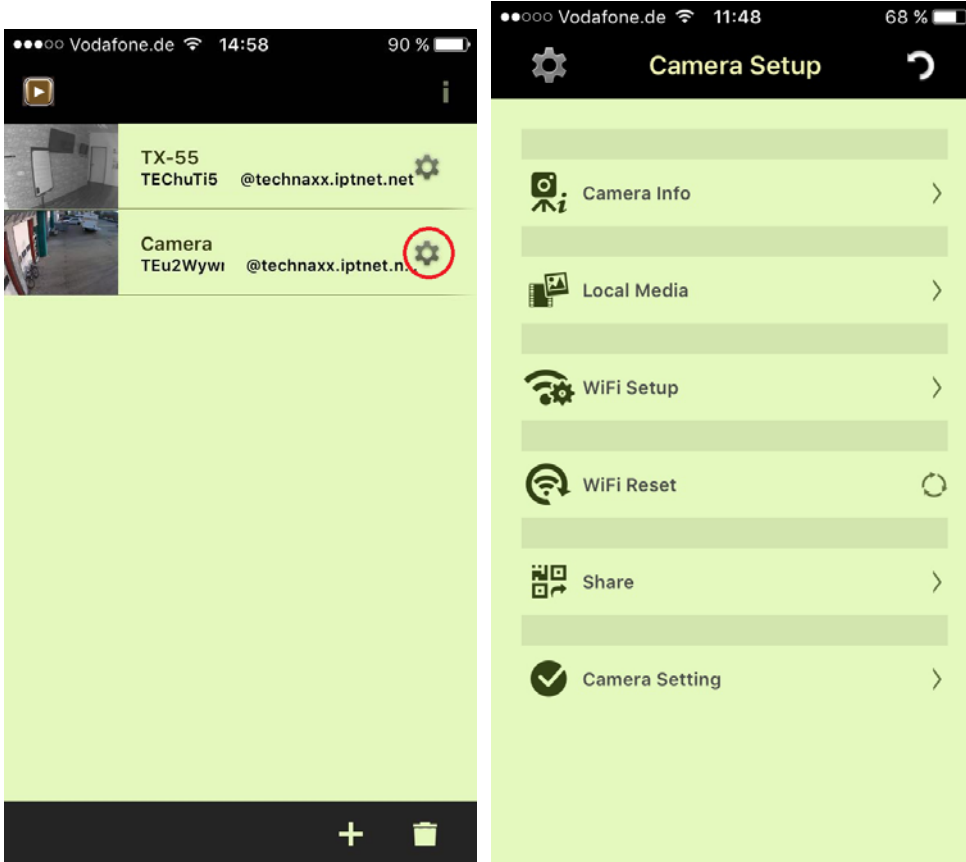

**Camera Info:** Here you can change the Camera Name. The Camera ID is unchanged. Firmware update is also possible.

**Local Media:** Images and Clips that were taken manually are saved here.



**WiFi Setup:** Configure the WiFi setup for your camera and select the WiFi network you want to connect your camera with.









**WiFi Reset:** The WiFi connection will be disconnected. You have to go to WiFi Setup and include the camera to a WiFi network again.



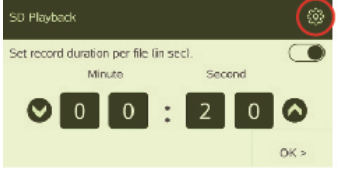

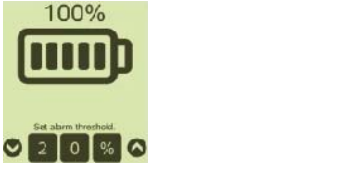
**Share:** You can share the camera to your family or friends. These users have only a restricted right. Press on this “Share” to open QR-Code ready. Open the APP on your friends Smartphone and add the camera by scanning scan. The device is added!

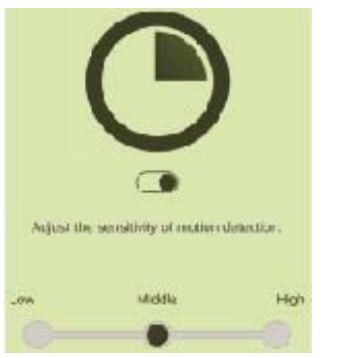
The shared user has only the following restricted rights: Camera Info, Local Media and Camera Clips. The user who configured the camera is the main user and has all rights for the settings.

## 6.2 Camera setting

At the main page press the button  and change to the next page, Camera Setup. Press the  **Camera Setting** option to open the Camera Setting page. See the functions below.

|                                                                                                                    |                                                                                     |                                                                                                                                                                                                                                                                                                           |
|--------------------------------------------------------------------------------------------------------------------|-------------------------------------------------------------------------------------|-----------------------------------------------------------------------------------------------------------------------------------------------------------------------------------------------------------------------------------------------------------------------------------------------------------|
| <p>Camera Storage Management</p>  |    | <p>Check the capacity of the MicroSD Card inserted in the camera.</p>                                                                                                                                                                                                                                     |
| <p>Camera Record Management</p>   |    | <p>View the event record list &amp; change the recording time per event (default 20 seconds). If turned OFF, no event video can be recorded. But the camera will still send out a push notification. (Pressing on an incoming push notification will get you directly to the live view of the device)</p> |
| <p>Battery Life</p>             |  | <p>Shows the rest of the battery life to know &amp; to change the battery before the camera goes off.</p>                                                                                                                                                                                                 |
| <p>IR</p>                       |                                                                                     | <p>Turn ON/OFF infrared LED's.</p>                                                                                                                                                                                                                                                                        |
| <p>Motion</p>                   |  | <p>Adjust the sensitivity of the PIR sensor for motion detection. Turn on this function, you have 3 options: Low =&gt; every motion is being detected and recorded, Middle =&gt; some objects are detected, High =&gt; big objects are detected.</p>                                                      |
| <p>Flip &amp; Mirror</p>        |                                                                                     | <p>Flip and mirror the live view image to match the mount position of the camera.</p>                                                                                                                                                                                                                     |

|                                                                                                                      |                                                                                   |                                                                            |
|----------------------------------------------------------------------------------------------------------------------|-----------------------------------------------------------------------------------|----------------------------------------------------------------------------|
| <p><b>Time zone</b></p>             |  | <p>Adjust the time zone to match your country of location.</p>             |
| <p><b>Power Line Frequency</b></p>  |  | <p>Adjust the power line frequency of match the local PAL/NTSC system.</p> |

## Important Safeguards and Warnings

- Do not expose the device to lampblack, steam or dust. Otherwise it may cause fire or electric shock.
- Do not install the device at position exposed to sunlight or in high temperature. Temperature rise in device may cause fire.
- Do not expose the device to humid environment. Otherwise it may cause fire.
- The device must be installed on solid and flat surface in order to guarantee safety under load and earthquake. Otherwise, it may cause device to fall off or turnover.
- Do not place the device on carpet or quilt.
- Do not place any object on the device.
- Do not disassemble the device.
- Battery Warnings: Use battery properly to avoid fire, explosion and other dangers. Replace used battery with battery of the same type. Do not use power line other than the one specified. Otherwise, it may cause fire or electric shock.

### Important Hint regarding the user manuals:

**All languages of the user manual are on the CD enclosed.**

The english and german version of the user manual is also as printed version enclosed.

**Warranty 2 years**



**Security and Disposal Hints for Batteries:** Hold children off batteries. When a child swallowed a battery go to a doctors place or bring the child into a hospital promptly! Look for the right polarity (+) and (-) of batteries! Always change all batteries. Never use old and new batteries or batteries of different types together. Never short, open, deform or load up batteries! **Risk of injury!** Never throw batteries into fire! **Risk of explosion!**

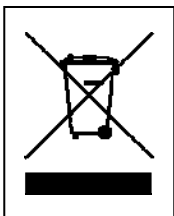

**Hints for Environment Protection:** Packages materials are raw materials and can be recycled. Do not disposal old devices or batteries into the domestic waste. **Cleaning:** Protect the device from contamination and pollution (use a clean drapery). Avoid using rough, coarse-grained materials or solvents/aggressive cleaner. Wipe the cleaned device accurately. **Distributor:** Technaxx Deutschland GmbH & Co.KG, Kruppstr. 105, 60388 Frankfurt a.M., Germany

**This product includes software developed by third parties, including software which is released under the GNU General Public License Version 2 (GPL v2). This program is free software; you can redistribute it and/or modify it under the terms of the GNU General Public License as published by the Free Software Foundation; either version 2 of the License, or (at your option) any later version. You may obtain a complete machine-readable copy of the source code for the above mentioned software under the terms of GPL v2 without charge except for the cost of media, shipping, and handling, upon written request to Technaxx GmbH & Co. KG, Kruppstraße 105, 60388 Frankfurt am Main, Germany.**

**This program is distributed in the hope that it will be useful, but WITHOUT ANY WARRANTY; without even the implied warranty of MERCHANTABILITY or FITNESS FOR A PARTICULAR PURPOSE. See the GNU General Public License for more details. You should have received a copy of the GNU General Public License along with this program; if not, write to the Free Software Foundation, Inc., 51 Franklin Street, Fifth Floor, Boston, MA 02110-1301, USA. (Notice from Technaxx: A copy of the GPL is included below).**

**GNU GENERAL PUBLIC LICENSE:** Version 2, June 1991 / Copyright (C) 1989, 1991 Free Software Foundation, Inc. / 51 Franklin Street, Fifth Floor, Boston, MA 02110-1301, USA. Everyone is permitted to copy and distribute verbatim copies of this license document, but changing it is not allowed.

## **Preamble**

The licenses for most software are designed to take away your freedom to share and change it. By contrast, the GNU General Public License is intended to guarantee your freedom to share and change free software--to make sure the software is free for all its users. This General Public License applies to most of the Free Software Foundation's software and to any other program whose authors commit to using it. (Some other Free Software Foundation software is covered by the GNU Lesser General Public License instead.) You can apply it to your programs, too.

When we speak of free software, we are referring to freedom, not price. Our General Public Licenses are designed to make sure that you have the freedom to distribute copies of free software (and charge for this service if you wish), that you receive source code or can get it if you want it, that you can change the software or use pieces of it in new free programs; and that you know you can do these things.

To protect your rights, we need to make restrictions that forbid anyone to deny you these rights or to ask you to surrender the rights. These restrictions translate to certain responsibilities for you if you distribute copies of the software, or if you modify it.

For example, if you distribute copies of such a program, whether gratis or for a fee, you must give the recipients all the rights that you have. You must make sure that they, too, receive or can get the source code. And you must show them these terms so they know their rights. We protect your rights with two steps: (1) copyright the software, and (2) offer you this license which gives you legal permission to copy, distribute and/or modify the software.

Also, for each author's protection and ours, we want to make certain that everyone understands that there is no warranty for this free software. If the software is modified by someone else and passed on, we want its recipients to know that what they have is not the original, so that any problems introduced by others will not reflect on the original authors' reputations.

Any free program is threatened constantly by software patents. We wish to avoid the danger

that redistributors of a free program will individually obtain patent licenses, in effect making the program proprietary. To prevent this, we have made it clear that any patent must be licensed for everyone's free use or not licensed at all.

The precise terms and conditions for copying, distribution and modification follow.

## **TERMS AND CONDITIONS FOR COPYING, DISTRIBUTION AND MODIFICATION**

**0.** This License applies to any program or other work which contains a notice placed by the copyright holder saying it may be distributed under the terms of this General Public License. The "Program", below, refers to any such program or work, and a "work based on the Program" means either the Program or any derivative work under copyright law: that is to say, a work containing the Program or a portion of it, either verbatim or with modifications and/or translated into another language. (Hereinafter, translation is included without limitation in the term "modification".) Each licensee is addressed as "you". Activities other than copying, distribution and modification are not covered by this License; they are outside its scope. The act of running the Program is not restricted, and the output from the Program is covered only if its contents constitute a work based on the Program (independent of having been made by running the Program). Whether that is true depends on what the Program does.

**1.** You may copy and distribute verbatim copies of the Program's source code as you receive it, in any medium, provided that you conspicuously and appropriately publish on each copy an appropriate copyright notice and disclaimer of warranty; keep intact all the notices that refer to this License and to the absence of any warranty; and give any other recipients of the Program a copy of this License along with the Program. You may charge a fee for the physical act of transferring a copy, and you may at your option offer warranty protection in exchange for a fee.

**2.** You may modify your copy or copies of the Program or any portion of it, thus forming a work based on the Program, and copy and distribute such modifications or work under the terms of Section 1 above, provided that you also meet all of these conditions:

**a)** You must cause the modified files to carry prominent notices stating that you changed the files and the date of any change. **b)** You must cause any work that you distribute or publish, that in whole or in part contains or is derived from the Program or any part thereof, to be licensed as a whole at no charge to all third parties under the terms of this License. **c)** If the modified program normally reads commands interactively when run, you must cause it, when started running for such interactive use in the most ordinary way, to print or display an announcement including an appropriate copyright notice and a notice that there is no warranty (or else, saying that you provide a warranty) and that users may redistribute the program under these conditions, and telling the user how to view a copy of this License. (Exception: if the Program itself is interactive but does not normally print such an announcement, your work based on the Program is not required to print an announcement). These requirements apply to the modified work as a whole. If identifiable sections of that work are not derived from the Program, and can be reasonably considered independent and separate works in themselves, then this License, and its terms, do not apply to those sections when you distribute them as separate works. But when you distribute the same sections as part of a whole which is a work based on the Program, the distribution of the whole must be on the terms of this License, whose permissions for other licensees extend to the entire whole, and thus to each and every part regardless of who wrote it. Thus, it is not the intent of this section to claim rights or contest your rights to work written entirely by you; rather, the intent is to exercise the right to control the distribution of derivative or collective

works based on the Program. In addition, mere aggregation of another work not based on the Program with the Program (or with a work based on the Program) on a volume of a storage or distribution medium does not bring the other work under the scope of this License.

**3.** You may copy and distribute the Program (or a work based on it, under Section 2) in object code or executable form under the terms of Sections 1 and 2 above provided that you also do one of the following:

**a)** Accompany it with the complete corresponding machine-readable source code, which must be distributed under the terms of Sections 1 and 2 above on a medium customarily used for software interchange; or, **b)** Accompany it with a written offer, valid for at least three years, to give any third party, for a charge no more than your cost of physically performing source distribution, a complete machine-readable copy of the corresponding source code, to be distributed under the terms of Sections 1 and 2 above on a medium customarily used for software interchange; or, **c)** Accompany it with the information you received as to the offer to distribute corresponding source code. (This alternative is allowed only for noncommercial distribution and only if you received the program in object code or executable form with such an offer, in accord with Subsection b above.)

The source code for a work means the preferred form of the work for making modifications to it. For an executable work, complete source code means all the source code for all modules it contains, plus any associated interface definition files, plus the scripts used to control compilation and installation of the executable. However, as a special exception, the source code distributed need not include anything that is normally distributed (in either source or binary form) with the major components (compiler, kernel, and so on) of the operating system on which the executable runs, unless that component itself accompanies the executable. If distribution of executable or object code is made by offering access to copy from a designated place, then offering equivalent access to copy the source code from the same place counts as distribution of the source code, even though third parties are not compelled to copy the source along with the object code.

**4.** You may not copy, modify, sublicense, or distribute the Program except as expressly provided under this License. Any attempt otherwise to copy, modify, sublicense or distribute the Program is void, and will automatically terminate your rights under this License. However, parties who have received copies, or rights, from you under this License will not have their licenses terminated so long as such parties remain in full compliance.

**5.** You are not required to accept this License, since you have not signed it. However, nothing else grants you permission to modify or distribute the Program or its derivative works. These actions are prohibited by law if you do not accept this License. Therefore, by modifying or distributing the Program (or any work based on the Program), you indicate your acceptance of this License to do so, and all its terms and conditions for copying, distributing/modifying the Program or works based on it.

**6.** Each time you redistribute the Program (or any work based on the Program), the recipient automatically receives a license from the original licensor to copy, distribute or modify the Program subject to these terms and conditions. You may not impose any further restrictions on the recipients' exercise of the rights granted herein. You are not responsible for enforcing compliance by third parties to this License.

**7.** If, as a consequence of a court judgment or allegation of patent infringement or for any other reason (not limited to patent issues), conditions are imposed on you (whether by court order, agreement or otherwise) that contradict the conditions of this License, they do not excuse you from the conditions of this License. If you cannot distribute so as to satisfy simultaneously your obligations under this License and any other pertinent obligations, then as a consequence you may not distribute the Program at all. For example, if a patent license would not permit royalty-free redistribution of the Program by all those who receive copies directly or indirectly through you, then the only way you could satisfy both it and this License would be to refrain entirely from distribution of the Program. If any portion of this section is held invalid or unenforceable under any particular circumstance, the balance of the section is intended to apply and the section as a whole is intended to apply in other circumstances. It is not the purpose of this section to induce you to infringe any patents or other property right claims or to contest validity of any such claims; this section has the sole purpose of protecting the integrity of the free software distribution system, which is implemented by public license practices. Many people have made generous contributions to the wide range of software distributed through that system in reliance on consistent application of that system; it is up to the author/donor to decide if he or she is willing to distribute software through any other system and a licensee cannot impose that choice. This section is intended to make thoroughly clear what is believed to be a consequence of the rest of this License.

**8.** If the distribution and/or use of the Program is restricted in certain countries either by patents or by copyrighted interfaces, the original copyright holder who places the Program under this License may add an explicit geographical distribution limitation excluding those countries, so that distribution is permitted only in or among countries not thus excluded. In such case, this License incorporates the limitation as if written in the body of this License.

**9.** The Free Software Foundation may publish revised and/or new versions of the General Public License from time to time. Such new versions will be similar in spirit to the present version, but may differ in detail to address new problems or concerns. Each version is given a distinguishing version number. If the Program specifies a version number of this License which applies to it and "any later version", you have the option of following the terms and conditions either of that version or of any later version published by the Free Software Foundation. If the Program does not specify a version number of this License, you may choose any version ever published by the Free Software Foundation.

**10.** If you wish to incorporate parts of the Program into other free programs whose distribution conditions are different, write to the author to ask for permission. For software which is copyrighted by the Free Software Foundation, write to the Free Software Foundation; we sometimes make exceptions for this. Our decision will be guided by the two goals of preserving the free status of all derivatives of our free software and of promoting the sharing and reuse of software generally.

## **NO WARRANTY**

**11.** Because the program is licensed free of charge, there is no warranty for the program, to the extent permitted by applicable law. Except when otherwise stated in writing the Copyright holder and/or other parties provide the program "AS IS" without warranty of any kind, either expressed or implied, including, but not limited to, the implied warranties of merchantability and fitness for a particular purpose. The entire risk as to the quality and



performance of the program is with you. Should the program prove defective, you assume the cost of all necessary servicing, repair or correction.

**12.** In no event unless required by applicable law or agreed to in writing will any Copyright holder, or any other party who may modify and/or redistribute the program as permitted above, be liable to you for damages, including any general, special, incidental or consequential. Damages arising out of the use or inability to use the program (including but not limited to loss of data or data being rendered inaccurate or losses sustained by you or third parties or a failure of the program to operate with any other programs), even if such holder or other party has been advised of the possibility of such damages.

### **END OF TERMS AND CONDITIONS**

### **HOW TO APPLY THESE TERMS TO YOUR NEW PROGRAMS**

**(1)** If you develop a new program, and you want it to be of the greatest possible use to the public, the best way to achieve this is to make it free software which everyone can redistribute and change under these terms. **(2)** To do so, attach the following notices to the program. It is safest to attach them to the start of each source file to most effectively convey the exclusion of warranty; and each file should have at least the "copyright" line and a pointer to where the full notice is found.

**<one line to give the program's name and an idea of what it does.>**

**Copyright (C) <yyyy> <name of author>**

**(3)** This program is free software; you can redistribute it and/or modify it under the terms of the GNU General Public License as published by the Free Software Foundation; either version 2 of the License, or (at your option) any later version. **(4)** This program is distributed in the hope that it will be useful, but WITHOUT ANY WARRANTY; without even the implied warranty of MERCHANTABILITY or FITNESS FOR A PARTICULAR PURPOSE. See the GNU General Public License for more details. **(5)** You should have received a copy of the GNU General Public License along with this program; if not, write to the Free Software Foundation Inc; 51 Franklin Street, Fifth Floor, Boston, MA 02110-1301, USA. **(6)** Also add information on how to contact you by electronic and paper mail. **(7)** If the program is interactive, make it output a short notice like this when it starts in an interactive mode: Gnomovision version 69, Copyright (C) year name of author Gnomovision comes with ABSOLUTELY NO WARRANTY; for details type `show w'. **(8)** This is free software, and you are welcome to redistribute it under certain conditions; type `show c' for details. **(9)** The hypothetical commands `show w' and `show c' should show the appropriate parts of the General Public License. Of course, the commands you use may be called something other than `show w' and `show c'; they could even be mouse-clicks or menu items--whatever suits your program. **(10)** You should also get your employer (if you work as a programmer) or your school, if any, to sign a "copyright disclaimer" for the program, if necessary. Here is a sample; alter the names: **(11)** Yoyodyne, Inc., hereby disclaims all copyright interest in the program `Gnomovision' (which makes passes at compilers) written by James Hacker. **<signature of Ty Coon>, 1 April 1989 [Ty Coon, President of Vice]** **(12)** This General Public License does not permit incorporating your program into proprietary programs. If your program is a subroutine library, you may consider it more useful to permit linking proprietary applications with the library. If this is what you want to do, use the GNU Lesser General Public License instead of this License.