

TECHNAXX®

**Technaxx WiFi IP-Cam Bullet PRO
FullHD Outdoor TX-65**

**Technaxx WiFi IP-Cam Dome PRO FullHD
Outdoor TX-66**

**Technaxx WiFi IP-Cam Speed Dome PRO
FullHD Outdoor TX-67**

I Table of Contents

I Table of Contents	2
1. Features	7
1.1 TX-65.....	7
1.2 TX-66.....	7
1.3 TX-67.....	7
2. Device Structure	8
2.1 Structure Info TX-65	8
2.2 Structure Info TX-66	10
2.3 Structure Info TX-67	10
3. Device Installation	11
3.1 Installation TX-65.....	11
3.2 Installation TX-66.....	12
3.3 Installation TX-67.....	16
4. Quick installation via App (My Secure Pro App)	19
4.1 WIFI configuration.....	19
4.2 P2P configuration	20
5. Quick Configuration Tool	21
5.1 Overview.....	21
5.2 Operation.....	21
6. Web Operation	23
6.1 Network Connection	23
6.2 Login and Main Interface	23
6.3 Live.....	25
6.4 PTZ (Only TX-67)	26
6.5 Playback (Only when MicroSD Card is inserted)	27
6.6 Setup	30
6.6.1 Camera.....	30
6.6.1.1 Conditions.....	30
A: Conditions	30
B: Profile management	30
6.6.1.2 Video	31
A: Video	31
B: Snapshot	31
C: Overlay	31
D: Path	31
6.6.2 Intelligent Video Surveillance (IVS) (only for TX-67).....	32
6.6.2.1 Global Setup.....	32
6.6.2.2 Scene Setup	32
6.6.2.2.1 Single Scene	33
6.6.2.2.2 Multiple-scene track	33

6.6.2.3 Rule Setup.....	34
6.6.2.3.1 Tripwire.....	34
6.6.2.3.2 Cross Warning Zone.....	35
6.6.2.3.3 Alarm Activation Setup.....	36
6.6.2.4 Parameter.....	37
6.6.3 Network.....	37
6.6.3.1 TCP/IP.....	37
A: TCP/IP.....	37
B: P2P/Easy4ip.....	37
6.6.3.2 Connection.....	38
A: Connection.....	38
B: PPPoE (Only TX-67).....	39
C: DDNS.....	39
D: IP Filter.....	39
E: SMTP (Email).....	39
F: UPnP.....	39
G: SNMP (Only TX-67).....	39
H: Bonjour.....	40
I: Multicast.....	40
J: WIFI.....	40
J.A: WIFI.....	40
J.B: WPS (only TX-65 & TX-66).....	41
K: 802.1x (Only TX-67).....	41
L: QoS.....	41
6.6.4 PTZ.....	41
6.6.5 Event.....	43
6.6.5.1 Video Detect.....	43
A: Motion Detect.....	43
B: Video Tamper.....	44
6.6.5.2 Abnormality.....	45
A: MicroSD Card (only when MicroSD Card is inserted).....	45
B: Network.....	45
C: Illegal Access.....	45
6.6.6 Storage.....	45
6.6.6.1 Schedule.....	45
A: Record Schedule.....	46
B: Snapshot Schedule.....	46
C: Holiday Schedule.....	46
6.6.6.2 Destination.....	47
A: Path.....	47
B: MicroSD card (Local).....	47
C: FTP.....	47

D: NAS	47
6.6.6.3 Record control	47
6.6.7 System.....	48
6.6.7.1 General.....	48
A: General	48
B: Date & Time	48
6.6.7.2. Account.....	48
6.6.7.3. Default	49
6.6.7.4. Import / Export	49
6.6.7.5. Auto Maintain	49
6.6.7.6. Upgrade.....	49
6.6.8. Information.....	50
6.6.8.1 Version.....	50
6.6.8.2 Log.....	50
6.6.8.3 Online User.....	50
7. Alarm	50
8. Logout.....	50
9. App Overview (My Secure Pro)	51
9.1 General Introduction	51
9.2 Features	51
9.3 Compatible Models	51
10. App short description	52
11. Operation.....	55
11.1 Remote Monitoring	55
11.2 Main Menu	55
11.3 Playback.....	56
11.3.1 Watch Playback.....	56
11.3.2 Picture Playback.....	57
To playback picture:	57
11.4 Device Manager	57
11.4.1 Add Device	58
11.4.1.1 P2P configuration.....	59
11.4.1.2 Quick DDNS configuration	59
11.4.1.4 WIFI configuration.....	60
11.4.2 Modify Device Info	62
11.4.3 Remote Configuration.....	62
11.4.3.1Video Detect	63
A: Motion Detect (Compare with chapter 6.6.3.1)	63
B: Video Mask	64
11.4.3.2 Camera Setting	64
A: Video Stream	64
11.4.3.3 Storage Manager	64

A: Schedule	64
11.4.3.4 User Manager	65
A: Modify Password	65
11.4.4 Alarm Out Control (optional)	65
11.4.5 View HDD Information	65
11.4.6 Delete Device	66
11.4.7 Import Cloud Device	66
11.5 Live Preview	67
11.5.1 Enable Monitoring.....	67
11.5.2 Close Monitoring.....	68
11.5.3 Snapshot	68
11.5.4 Record	68
11.5.5 Playback	69
11.5.6 Bidirectional Talk (not for TX-65, 66, 67)	69
11.5.7 Unlock (optional).....	69
11.7.8 PTZ Direction and Zooming (Only TX-67)	69
11.7.8.1 Direction and Zooming	69
11.7.8.2 Preset	70
11.7.9 Fish-eye (optional)	70
11.7.10 Bit Stream Switch	70
11.7.12 Audio (optional).....	71
11.7.12 Light Control (optional)	71
11.7.13 Image Adjustment.....	71
11.7.14 Full Screen	72
11.7.14.1 Zoom In.....	72
11.7.14.2 Window Position Switch	72
11.7.15 Local Files	72
11.7.15.1 View File	72
11.7.15.2 Share File.....	73
11.7.15.3 Export File.....	73
11.7.15.5 Delete File.....	73
11.7.16 E-Map	73
11.7.16.1 Create E-Map.....	73
11.7.16.2 Edit E-Map	74
11.7.17 Favorites	74
11.7.18 Alarm Manager	75
11.7.18.1 Push Configuration	75
11.7.18.2 Instant View of Alarm Push	75
11.7.18.3 Alarm Push Event List.....	76
11.7.19 More/ Local Configuration/ Help	76
11.7.19.1 Local Configuration	76
11.7.19.2 Help	76

12. Technical Specifications	77
12.1 TX-65.....	77
12.2 TX-66.....	78
12.3 TX-67.....	79
GNU GENERAL PUBLIC LICENSE.	81
Preamble	81
TERMS AND CONDITIONS FOR COPYING, DISTRIBUTION AND MODIFICATION.....	82

This device complies with the requirements of the standards referred to the Directive **R&TTE 2014/53/EU**. The Declaration of Conformity you find here: www.technaxx.de/ (in bar at the bottom “Konformitätserklärung”). Before using the device the first time, read the user manual carefully.

Service phone No. for technical support: 01805 012643 (14 cent/minute from German fixed-line and 42 cent/minute from mobile networks). Free Email: support@technaxx.de

If you drill a hole in the wall, please make sure that power cables, electrical cords and/or pipelines are not damaged. When using the supplied mounting material, we do not take the liability for a professional installation. You are entirely responsible to ensure that the mounting material is suitable for the particular masonry, and that the installation is done properly. When working at higher altitudes, there is danger of falling! Therefore, use suitable safeguards.

Important Hint regarding the user manuals:

All languages of the user manual are on the CD enclosed.

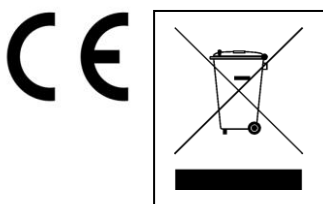

Hints for Environment Protection: Packages materials are raw materials and can be recycled. Do not disposal old devices or batteries into the domestic waste. **Cleaning:** Protect the device from contamination and pollution (use a clean drapery). Avoid using rough, coarse-grained materials or solvents/aggressive cleaner. Wipe the cleaned device accurately. **Distributor:** Technaxx Deutschland GmbH & Co.KG, Kruppstr. 105, 60388 Frankfurt a.M., Germany

1. Features

1.1 TX-65

- 1/3" 3Megapixel progressive scan CMOS
- H.264&MJPEG dual-stream encoding
- Max 20fps@3M(2048x1536)&25/30fps@1080P(1920x1080)
- DWDR, Day/Night(ICR), 3DNR, AWB, AGC, BLC
- Multiple network monitoring: Web viewer, My Secure Pro PC Client, My Secure Pro App
- 3.6mm fixed lens (2.8mm optional)
- Max. IR LEDs Length 30m
- IP67
- Micro SD card slot, up to 128GB
- Wi-Fi support

1.2 TX-66

- 1/3" 3Megapixel progressive scan CMOS
- H.264&MJPEG dual-stream encoding
- Max 20fps@3M(2048x1536) (2304x1296)&25/30fps@1080P(1920x1080)
- DWDR, Day/Night(ICR), 3DNR, AWB, AGC, BLC
- Multiple network monitoring: Web viewer, My Secure Pro PC Client, My Secure Pro App
- 3.6mm fixed lens (2.8mm optional)
- Max. IR LEDs Length 30m
- IP67, IK10
- Micro SD card slot, up to 128GB
- Wi-Fi support

1.3 TX-67

- 1/2.8" 2Megapixel progressive scan CMOS
- H.264 & MJPEG dual-stream encoding
- Max 25/30fps@1080P
- Day/Night(ICR), 3DNR, AWB,AGC,BLC
- Multiple network monitoring: Web viewer, My Secure Pro PC Client, My Secure Pro App
- Max 100°/s preset speed, ±180° Pan range, 90° Tilt range
- 3.6mm fixed lens
- IP67, IK10
- Micro SD card slot, up to 128GB
- Wi-Fi support

2. Device Structure

2.1 Structure Info TX-65

Refer to the following figure for cable information. See Figure 2-1.

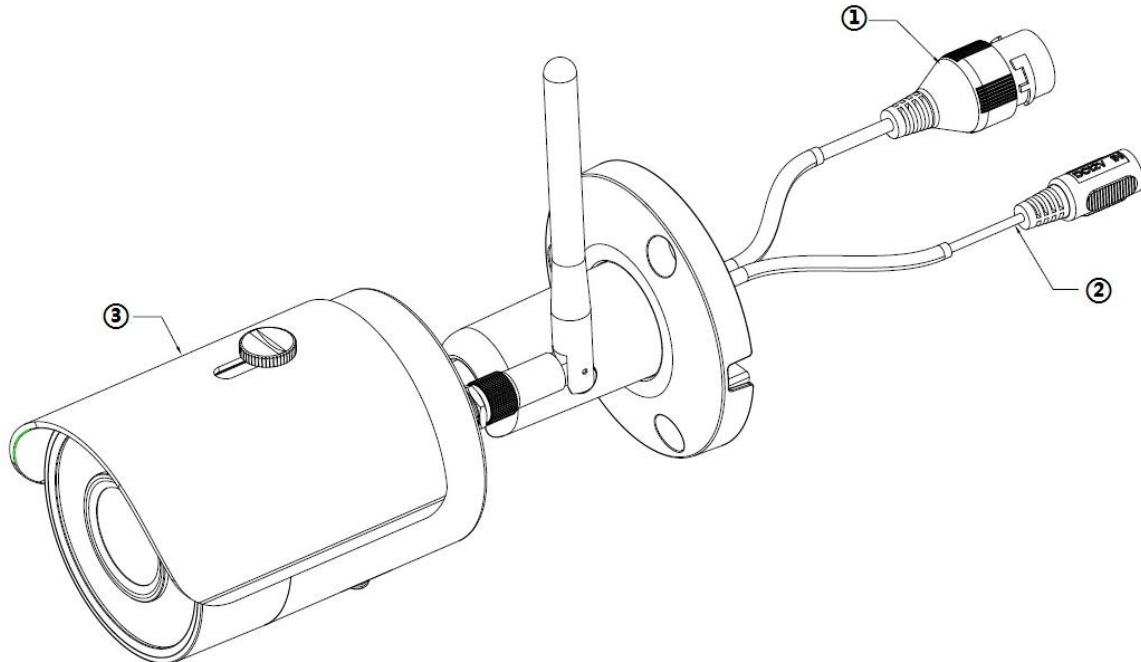

Figure 2-1

Refer to the following sheet for detailed information.

No.	Port Name	Function	Connection	Note
1	LAN	Network port	Ethernet port	Connect to standard Ethernet cable. Note: Some devices do not support PoE. Before making crystal head, pull the anti-dust, waterproof cover through network cable.
2	DC 12V	Power input port		Power port. Input DC 12V.
3	Screw	Adjust the shield		Adjust the shield to reduce solar irradiation and raindrop on the camera front.

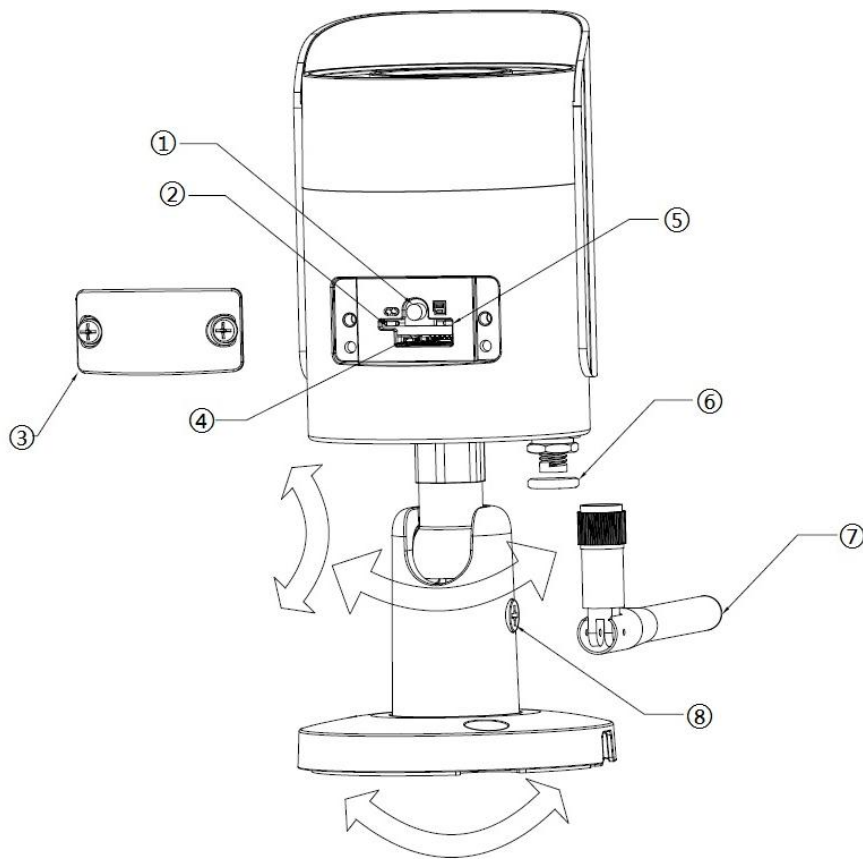

Figure 2-2

Refer to the following sheet for detailed information.

SN	Name	SN	Name
①	Reset/WPS button	⑤	Indicator light 2
②	Indicator light 1	⑥	Waterproof ring
③	Lower cover	⑦	Wifi antenna
④	Micro SD card slot	⑧	Locking screw

Indicator light status	Device status
Red light normally on	Booting
Green light slow flashing	Booting completed, await wifi config, enter smart config status
Green light quick flashing	Wifi smart config in progress, including WPS, management frame and etc.
Green light normally on	Wifi connection succeeded, operate normally.
Red and green lights flash alternately	Device upgrade
Red light slow flashing	Network connection failure or disconnection after network connection success.
Red light quick flashing	Device malfunction, fail to boot up; alarm or SD card malfunction

2.2 Structure Info TX-66

Note: The following figure is for reference only, which is used to know the components and cable port function. There are differences about structure components and cables between different models, refer to the actual object for more details. Refer to the following figure for component structure. See Figure 2-3

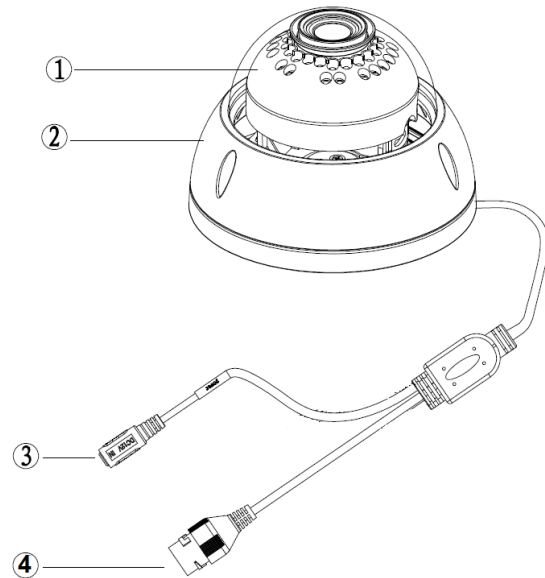

Figure 2-3

Number	Component Name	Note
1	Dome module	
2	Dome enclosure	
3	Power input port	Connect to DC 12V power, input power.
4	Network access port	Send/ receive network data

2.3 Structure Info TX-67

Refer to the following figures for components information. See Figure 2-4.

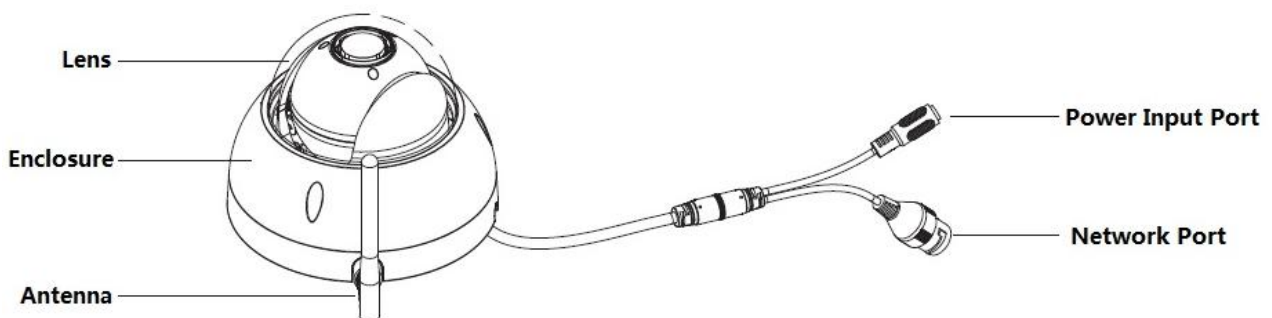

Figure 2-4

Lens	Power input Port
Enclosure	Network Port
Antenna	

3. Device Installation

Important Note:

- Before the installation, make sure the installation environments can at least support 3x weight of the camera and the bracket.

3.1 Installation TX-65

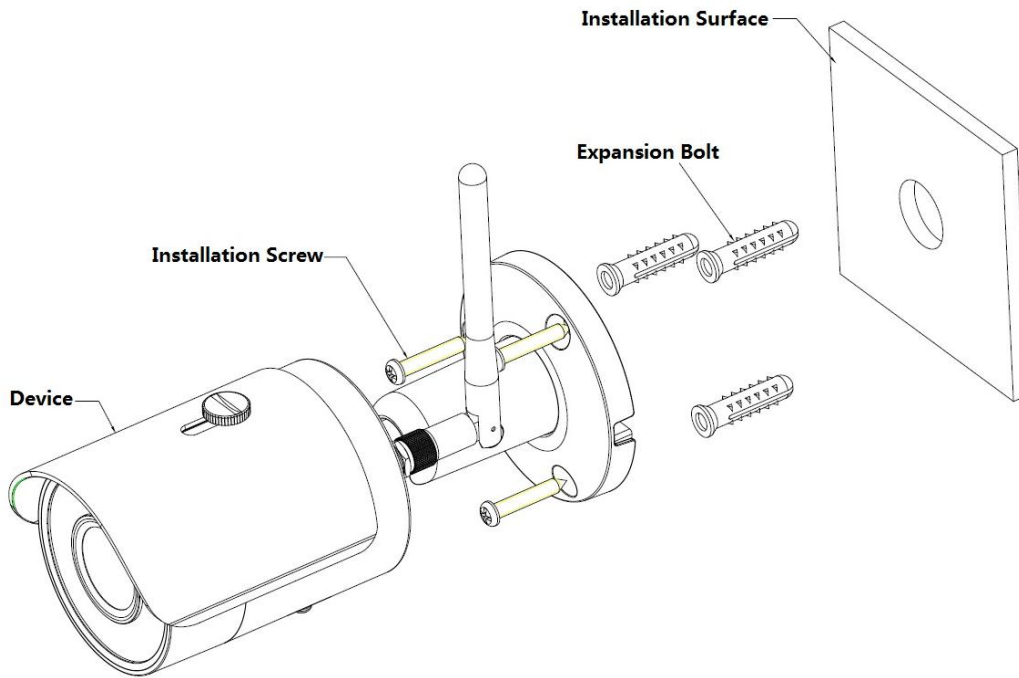

Figure 3-1

Network Camera (Device)
Installation Screw
Expansion Bolt
Installation Surface

See Figure 3-1 and Figure 3-2.

Step 1: Stick installation sticker to designated surface where you will install the device (wall or ceiling).

Step 2: Dig a hole according to position of hole on installation sticker.

Step 3: Open accessories bag, take out expansion bolt and insert it into the hole you just dug.

Step 4: Open accessories bag, take out screw. Tighten the 4 screws to fix the device on the installation surface (wall or ceiling). Move device sunshade back and forth. When you have fixed the device, you must tighten screws on sunshade.

Step 5: Plug external wiring of the device properly.

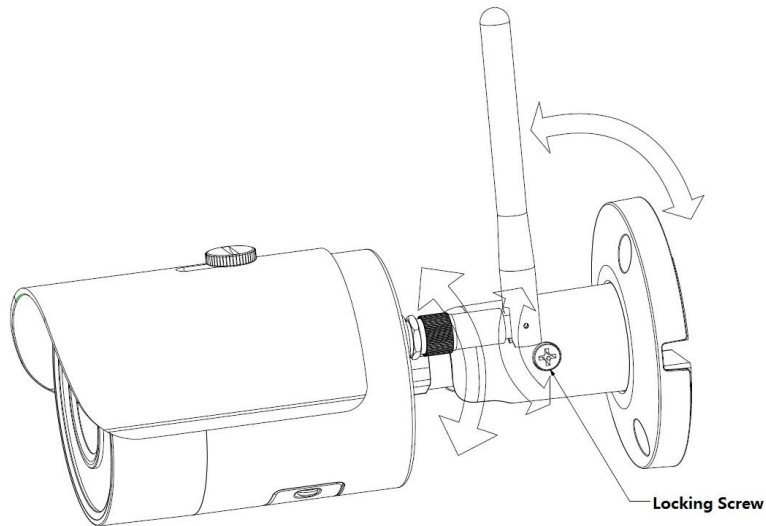

Figure 3-2

Locking Screw

Step 6: Use Philip's head screwdriver (in accessories bag) to loosen Locking screw.

Step 7: Adjust the device in all possible directions, and set its monitoring direction.

Step 8: Use Philip's head screwdriver to tighten the screws.

3.2 Installation TX-66

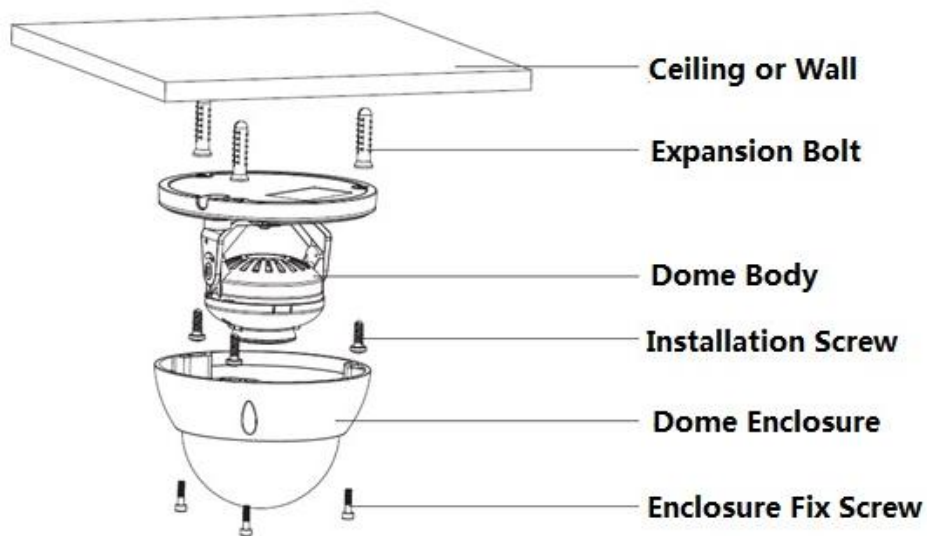

Figure 3-3

Ceiling or Wall
Expansion Bolt
Dome Body
Installation Screw
Dome Enclosure
Enclosure Fixed Screw

Step 1: Use inner hex wrench in the accessories bag to open dome enclosure by unfastening three inner hex screws on enclosure.

Step 2: Take out the installation position map in the accessories bag, and then paste it on the ceiling or the wall according to your monitor area requirements.

Step 3: Find cross signs on the map, and dig three plastic expansion bolts holes on the installation surface and then insert three expansion bolts in the holes. Secure these three bolts firmly.

Note:

- If user pulls out cable from top of installation surface, you must dig an exit hole on installation surface according to the installation position map.
- If user pulls out cable from side of cable channel, it must go through the U-shape channel on dome pedestal, and take out cable from the side exit hole on pedestal.

Step 4: Adjust the device installation pedestal to the proper position and then pull cable through the exit hole on Installation surface. Make direction of TOP sign same as it on installation position map. Line up the three screw holes in the device pedestal to the three plastic expansion bolt holes in the installation position. Put the three self-tapping screws in the three plastic expansion bolts firmly. Fix dome body on installation surface.

Step 5:

- a) Hold both sides of the rotation bracket bottom with hands, rotate the bracket horizontally, and adjust lens horizontal direction to designated position. Loosen one M2 screw on fixed LED decoration cover (loosen only, do not take it down), hold the decoration cover with hand, making lens rotate vertically. Adjust vertical direction of lens monitoring image to appropriate angle, and fasten the fix screw on the decoration cover. Range of lens: vertical ($0^{\circ} \sim +65^{\circ}$), horizontal ($0^{\circ} \sim +355^{\circ}$).
- b) Hold both sides of the rotation bracket bottom with hands, rotate horizontally along the axis, and adjust lens horizontal direction to designated position. Hold the LED decoration cover with hand, rotate along the vertical direction, adjust the lens vertical direction to designated position; it is okay to loosen the fix screws on both sides of the bracket first if it is too tight to adjust (just make it loose, do not take it down), then adjust the lens, tighten the fix screws after adjustment. Hold the LED decoration cover with hands, rotate horizontally along the axis, and adjust the lens image to designated position. Range of lens: vertical ($0^{\circ} \sim +64^{\circ}$), horizontal ($0^{\circ} \sim +355^{\circ}$), image rotation direction ($0^{\circ} \sim +355^{\circ}$).

Note:

When it rotates to 64° vertically, pay attention to the image rotation direction in order to avoid the outer cover blocking IR light and influencing IR effect.

MicroSD Card Installation

Note: Some series products do not support the MicroSD card function, which can't be applied to the following chapter.

Shut down the power and then turn off the device before you install the MicroSD card.

Step 1: Find the MicroSD Card slot in Figure 3-6; open the Micro SD Card slot according to the direction in Figure 3-4.

Step 2: Adjust the MicroSD Card to proper direction and install it into the MicroSD card slot.

Step 3: According to the direction in Figure 3-5, close the MicroSD card slot and keep it locked.

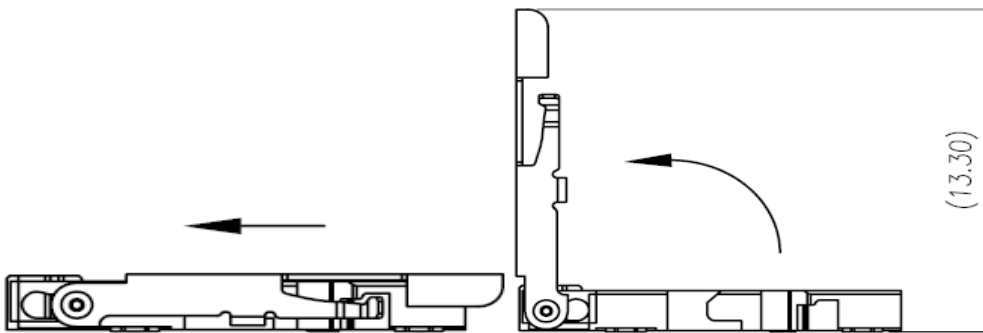

Figure 3-4

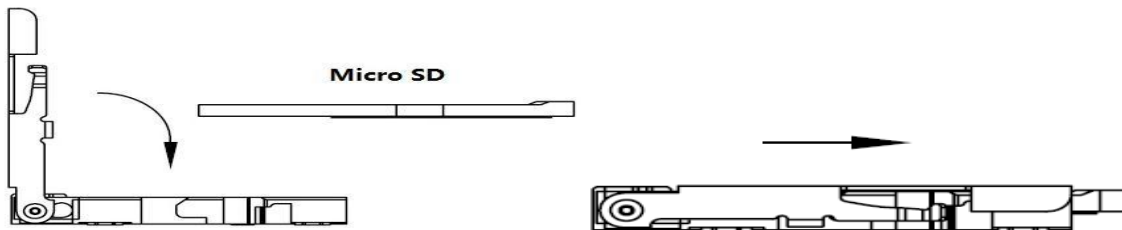

Figure 3-5

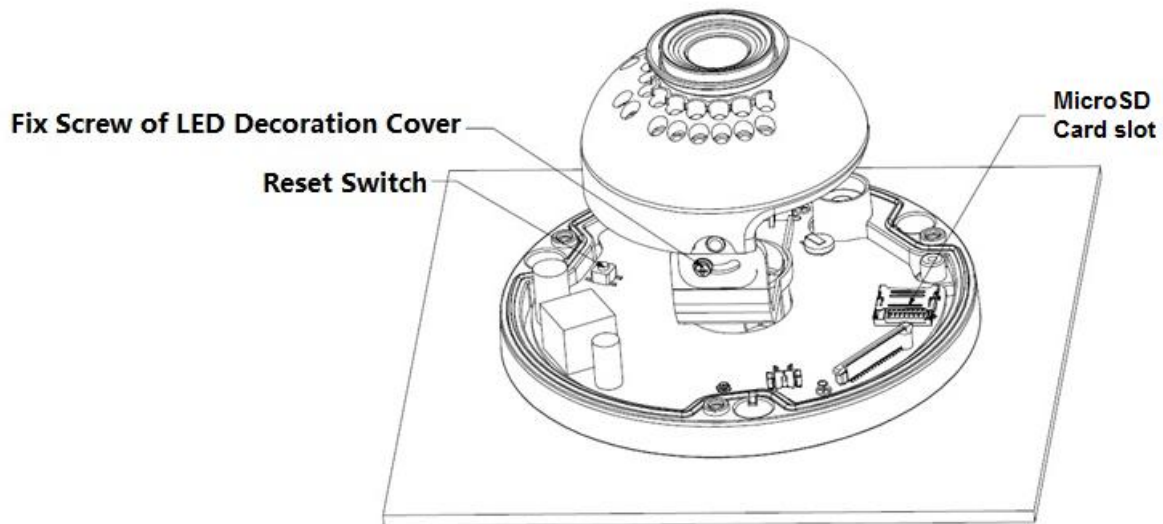

Figure 3-6

Fix Screw of LED Decoration Cover
Reset Switch
Micro SD Karte slot

Note:

- Long press the “Reset button” shown in Figure 3-6 for 10 seconds when the device is power on if the device needs to restore to factory setting.
- If the device needs to use WPS function, short press the “Reset button” shown in Figure 3-6 for 1~2 seconds when the device is power on, press the WPS button of the router, generally the device can connect to corresponding router within 1 minute (only supported by some models).
- Some models do not have vertical rotating ring component, which does not support image rotation, refer to the actual product.
- There are some differences about IR light layout for some models, refer to the actual products.

Step 4: Take up the dome enclosure, put it back on the camera properly regarding to screw and hole, and fasten the three inner hex screws with wrench. So far the installation is completed.

3.3 Installation TX-67

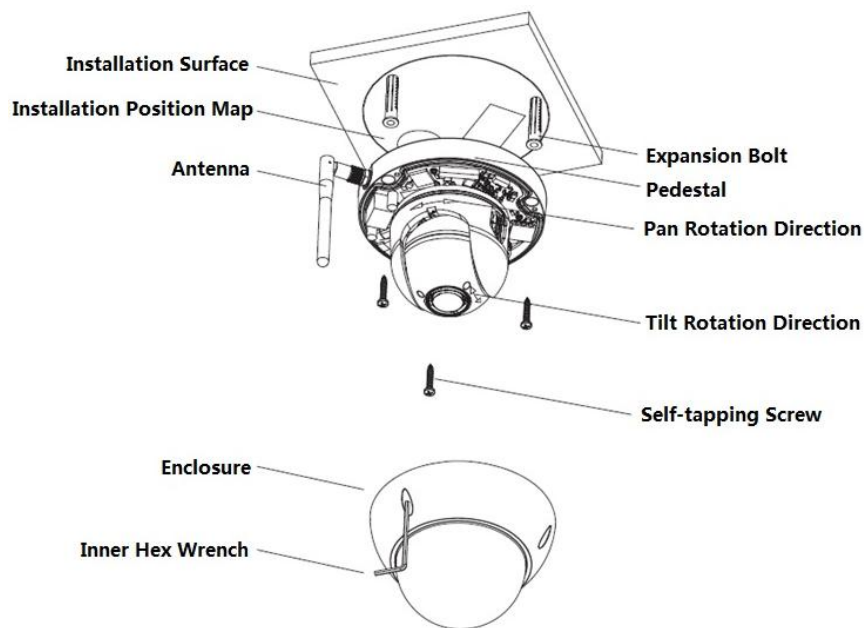

Figure 3-7

Installation Surface
Installation Position Map
Antenna
Enclosure
Inner Hex Wrench
Expansion Bolt
Pedestal
Pan Rotation Direction
Tilt Rotation Direction
Self-tapping Screw

Follow the steps listed below to install the device. Refer to Figure 3-7 for reference.

Step 1: Take the installation position map in the accessories bag, and then paste it on the ceiling or the wall according to your monitor area requirements. Draw and then dig three plastic expansion bolts holes in the installation surface and then insert three expansion bolts in the holes. Secure these three bolts firmly. Draw the cable out from the cable exit when you install the device.

Step 2: Adjust the device installation pedestal to the proper position and then line up the three screw holes in the device pedestal to the three plastic expansion bolt holes in the installation position. Put the three self-tapping screws in the three plastic expansion bolts and lock them firmly.

Step 3: Aim the three slots on the dome body to the three corresponding snaps on the installation pedestal and then push up slowly until you hear it “click”

Step4: Take out the fastening screw from the accessories bag and screw it (in Figure 3-7) into the corresponding threaded holes of the dome body to tighten the installation pedestal and prevent falling. The fastening screw of vandal-proof dome is M2.5*7 hexagon socket head stainless screw while the fastening screw of non vandal-proof dome is cross recess self-tapping screw, refer to the actual object in the accessories bag.

Note: The device supports bottom cable exit and side cable exit; refer to the following Figure 3-8 for side cable exit.

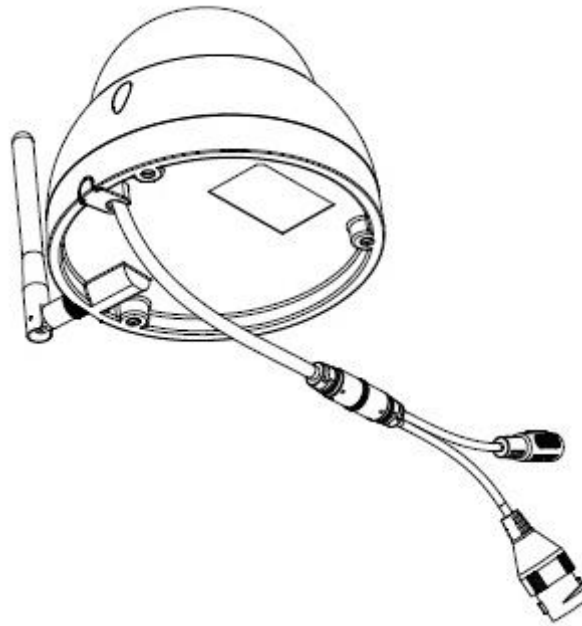

Figure 3-8

Restore Factory Default Setup Introduction

Important: Use RESET button when device is running. See Figure 3-9 for the location of RESET button, which is the same for both vandal-proof dome and non vandal-proof dome.

Step 1: Use inner hex wrench in the accessories bag to open dome enclosure by unfastening three inner hex screws on enclosure.

Step 2: Figure 3-9 shows the position of the Reset button.

Step 3: To reset the device press and hold the Reset button for about 30 seconds.

Step 4: Install the dome back to quick installation pedestal

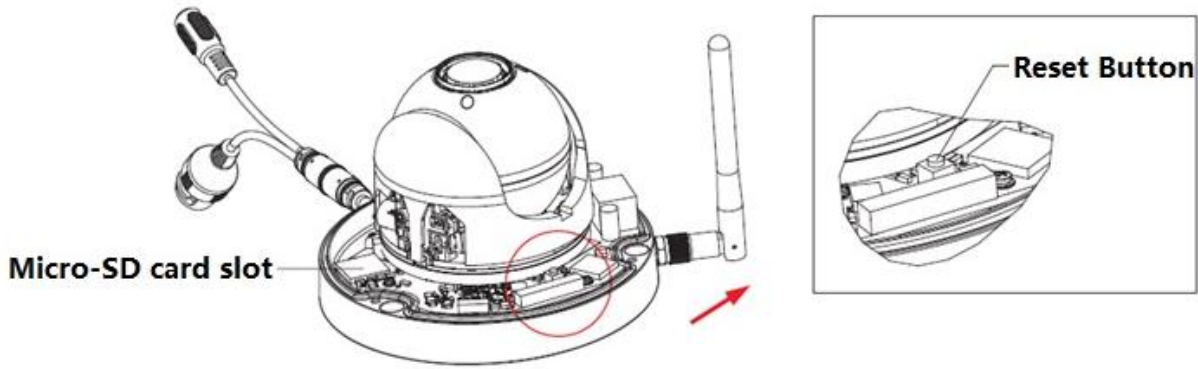

Figure 3-9

Reset button
MicroSD Karte slot

MicroSD Card Removal and Installation (see Figure 3-9)

Note: Cut off the power when you need to remove and install MicroSD card, power on after you finish MicroSD card removal or installation.

Step 1: Use inner hex wrench in the accessories bag to open dome enclosure by unfastening three inner hex screws on enclosure.

Step 2: Figure 3-9 shows the position of the Reset button.

Step 3: Open the MicroSD card slot like in figure 3-10.

Step 4: Adjust the Micro SD Card to proper direction and install it into the Micro SD card slot.

Step 5: According to the direction in Figure 3-11, close the Micro SD card slot and keep it locked.

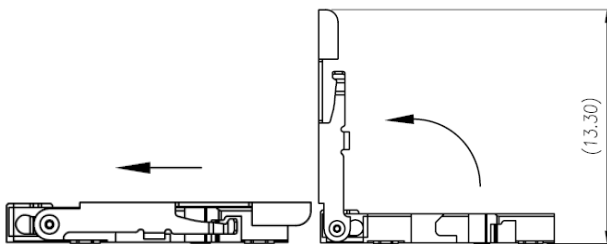

Figure 3-10

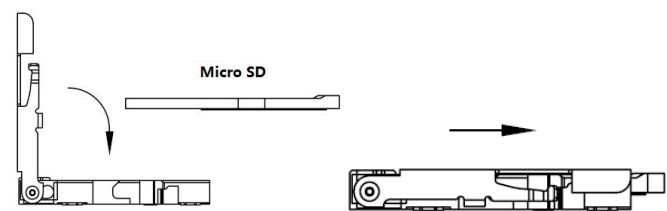

Figure 3-11

Step 6: Install the dome back to quick installation pedestal

4. Quick installation via App (My Secure Pro App)

The product has Android and iOS versions.

Android: Open Google Play App in your smart phone. Search “My Secure Pro”, download it and install it.

iOS: Open App Store App in your smart phone. Search “My Secure Pro”, download it and install it.



4.1 WIFI configuration

To add device: Click on , system displays main menu interface in Figure 4-1.

In device manager interface (Figure 4-2), click on  to enter add device interface, see Figure 4-3.

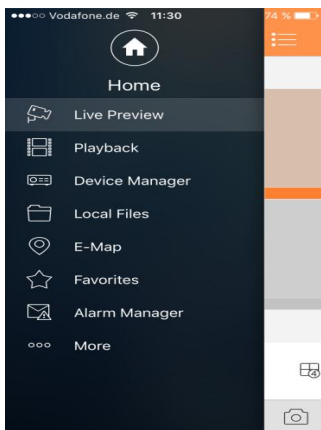

Figure 4- 1

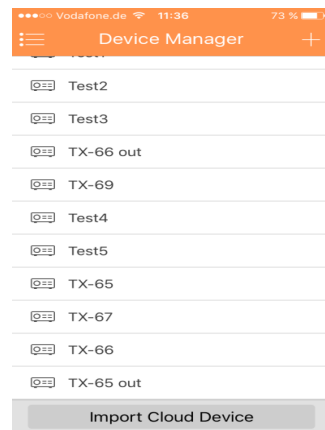

Figure 4-2

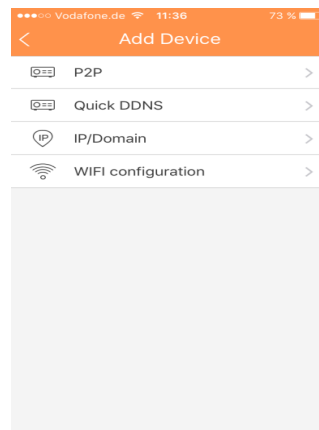



Figure 4-3

1. Interface display: Name, SN (QR code), username, password, live preview, and playback. See Figure 4-4.

2. Click , scan QR code (on device or Web interface Setup→network→TCP/IP→P2P/Easy4ip) and the picture will be like Figure 4-4.

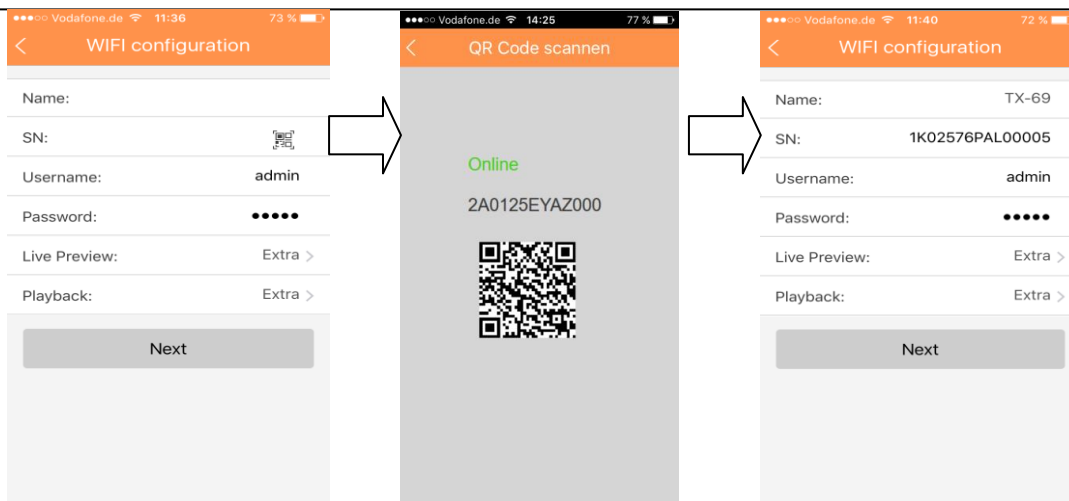

Figure 4- 4

4. Your Smartphone will use the WIFI connection you are currently connected to. Insert the password of your WIFI router like seen in figure 4-5.
5. Press “Next” button.
6. System auto configure (wait). Figure 4-6
7. If failed, then click try again or repeat the above steps.
8. All configurations are saved automatically, when correct. See figure 4-7.
9. Press “Start Live preview”. See figure 4-7.

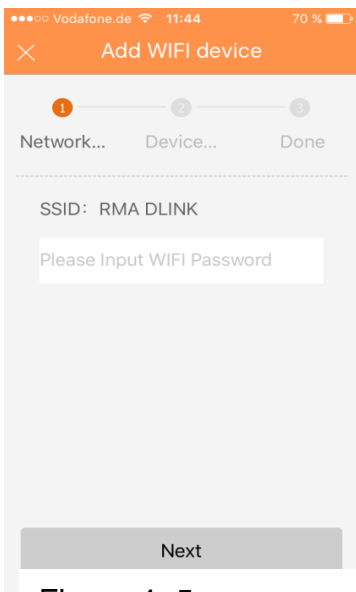

Figure 4- 5

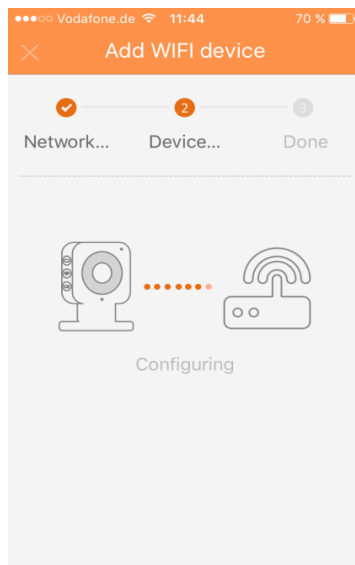

Figure 4- 6

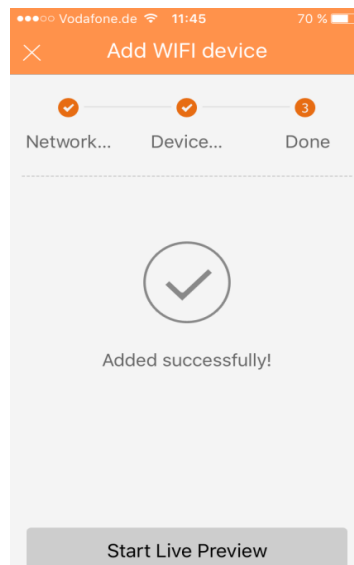



Figure 4- 7

4.2 P2P configuration

This option can only be used when the camera is already connected to the LAN or connected to the WIFI.

1. Press on the button  and scan the QR-Code of the device. See Figure 4-8
 2. Name the device connection.
 3. Username and Password are default (admin/admin).
 4. Select in Live Preview between Main and Extra stream.
Default: Extra stream
- Note:** Under poor network environment we suggest to set to Extra stream.
5. Press to save: 

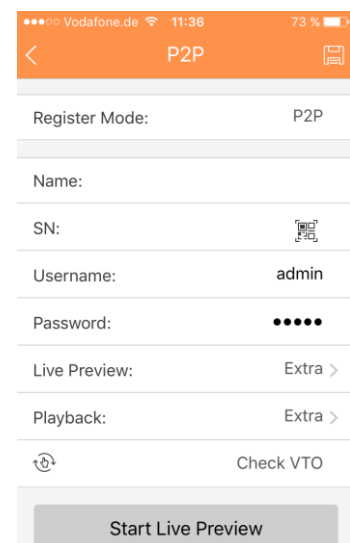



Figure 4-8

5. Quick Configuration Tool

5.1 Overview

Quick configuration tool can search current IP address, modify IP address. At the same time, use it to upgrade the device. Note the tool only applies to the IP addresses in the same segment. Find the tool on the CD. 

5.2 Operation

One quick press on the network button (camera) and one quick press on the router (WPS), then the device can be connected to WIFI successfully. Double click the “**ConfigTools.exe**” icon; see an interface is shown as in Figure 5-1.

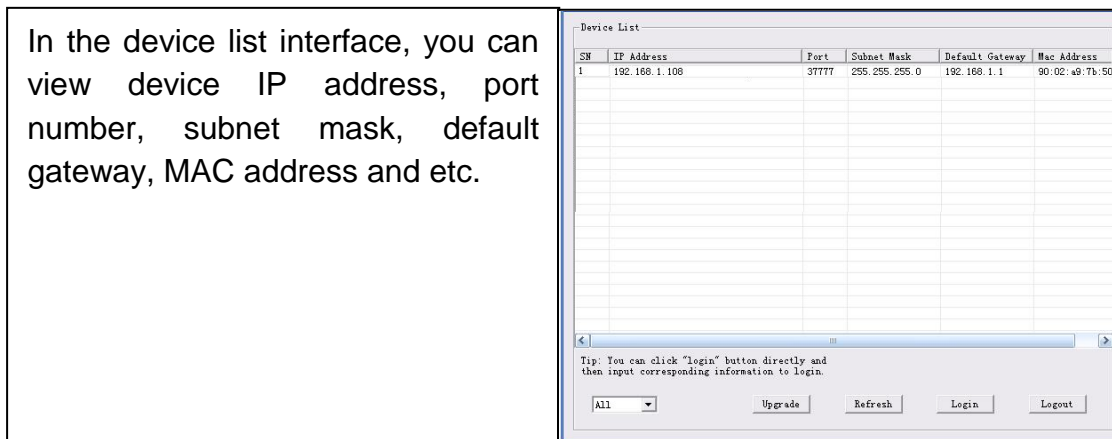

Figure 5-1

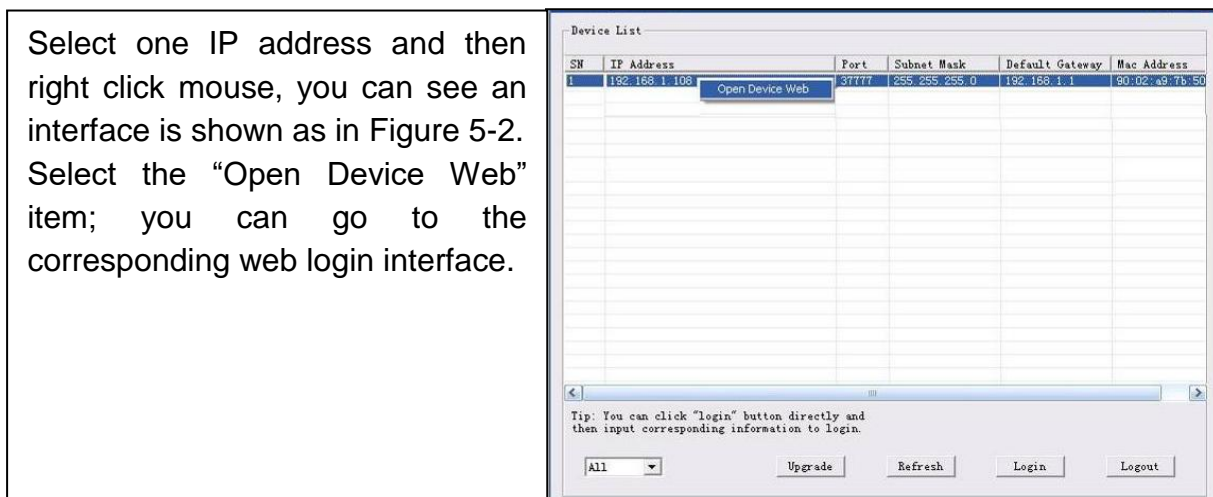

Figure 5-2

If you want to modify the device IP address without logging in the device web interface, go to the configuration tool main interface to set.

In the configuration tool search interface (Figure 5-1), select a device IP address and then double click it to open the login interface. Or select an IP address and then click the Login button to go to the login interface. See Figure 5-3.

In Figure 5-3, view device IP address, user name, password and port.

Note the port information here shall be identical with the port value you set in TCP port in Web Network interface. Otherwise, you cannot login the device.

If you are using device background upgrade port 3800 to login, other setups are all invalid.

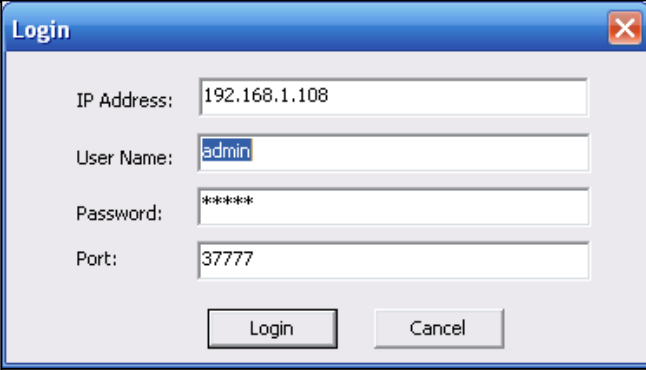

The image shows a 'Login' dialog box with a blue title bar and a close button (X) in the top right corner. It contains four input fields: 'IP Address' with the value '192.168.1.108', 'User Name' with the value 'admin', 'Password' with the value '*****', and 'Port' with the value '37777'. At the bottom of the dialog are two buttons: 'Login' and 'Cancel'.

Figure 5-3

After you logged in, the configuration tool main interface is shown as below. See Figure 5-4.

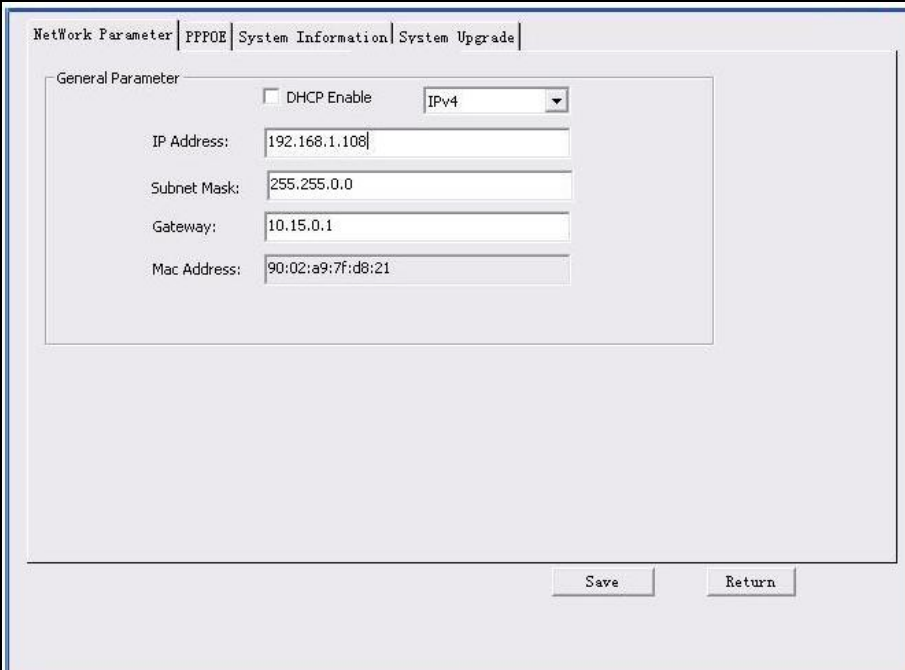

The image shows the main configuration tool interface. At the top, there are four tabs: 'Network Parameter', 'PPPOE', 'System Information', and 'System Upgrade'. The 'Network Parameter' tab is selected. Below the tabs is a 'General Parameter' section. It contains a 'DHCP Enable' checkbox (unchecked) and a dropdown menu set to 'IPv4'. Below these are four input fields: 'IP Address' (192.168.1.108), 'Subnet Mask' (255.255.0.0), 'Gateway' (10.15.0.1), and 'Mac Address' (90:02:a9:7f:d8:21). At the bottom of the interface are two buttons: 'Save' and 'Return'.

Figure 5-4

6. Web Operation

This series network camera products support the Web access and management via PC. Web includes several modules: Monitor channel preview, system configuration, alarm, etc.

6.1 Network Connection

Follow the steps listed below for network connection.

- Make sure the network camera has connected to the network properly.
- Set the IP address, subnet mask and gateway of the PC and the network camera respectively. Network camera default IP address is 192.168.1.108. Subnet mask is 255.255.255.0. Gateway is 192.168.1.1
- Use order ping `***.***.***.***`(* network camera address) to check connection is OK or not.

6.2 Login and Main Interface

Open IE/ Mozilla (Chrome/Safari optional) and input network camera address in the address bar. See Figure 6- 1.

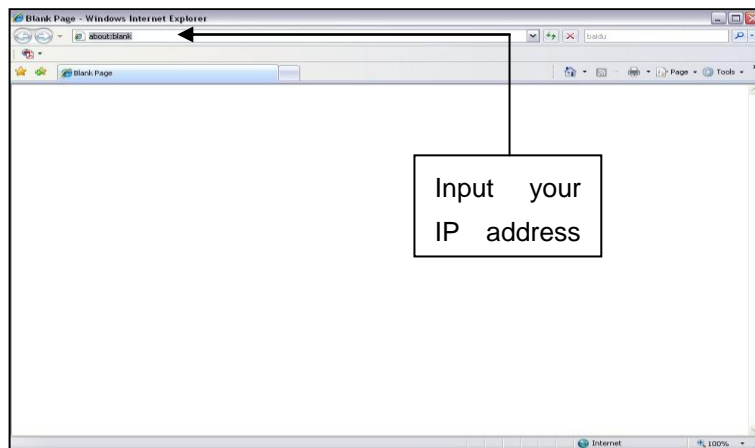

Figure 6- 1

The login interface is shown on Figure 6- 2.

Input your user name and password.
Default factory **name is admin** and **password is admin.**

Note: For security reasons, modify your password after you first login.



Figure 6- 2

If it is your first time to log in, the system pops up a warning information to ask you whether you like to install the web plug-in or not. Install the web plug-in. After you logged in, see the main window. See figure 6-3.

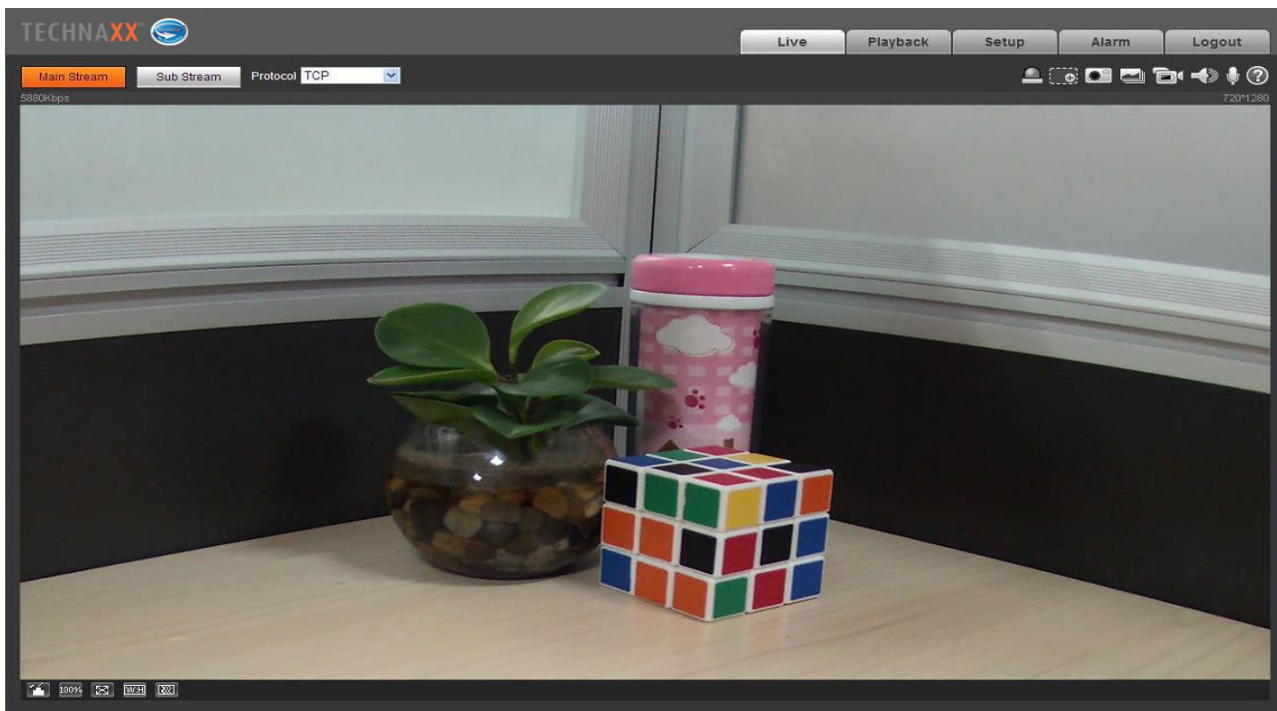

Figure 6- 3

Note:

- This quick start guide is for reference only. Slight difference may be found in user interface.
- All the designs and software here are subject to change without prior written notice.
- All trademarks and registered trademarks mentioned are the properties of their respective owners.
- If there is any uncertainty or controversy, refer to the final explanation of us.
- Visit our website or contact your local service engineer for more information.

6.3 Live

In this section you are going to see the live video, after your login was successful. Select the streaming mode and the protocol type. The symbols at the right corner of the display are described as followed:



Digital zoom – There are two options to zoom. Click it, to activate the function:

1. By holding the left mouse button open up a rectangle to zoom in any area of the live video and the playback (drag to zoom).
2. Use your mouse wheel to zoom the video size.

Right click the mouse to restore previous status (Live video/ playback)



Snapshot - Click it to take a picture of the current live video. The path where the picture is saved can be found in the web plug-in under: Setup/ Camera/ Video/ Path.



Triple Snapshot – Click it, the system begins to take 1 picture per second. The path where the pictures are saved can be found in the web plug-in under: Setup/ Camera/ Video/ Path



Manual record - Click it to shoot a video of the live stream. The path where the video is saved can be found in the web plug-in under: Setup/ Camera/ Video/ Path



Audio (optional) - Click it to enable/disable the audio output of the live stream at your Web Interface.



Bidirectional talk (optional) - Click it to enable/disable bidirectional talk.



Press this button to get the help file for better understanding!

<ol style="list-style-type: none">1. Image Adjustment2. Original Size3. Full Screen4. Wide Screen (W:H)5. Adjust Fluency	<table border="1"><tr><td data-bbox="646 1413 798 1478">1</td><td data-bbox="798 1413 949 1478">2</td><td data-bbox="949 1413 1101 1478">3</td><td data-bbox="1101 1413 1252 1478">4</td><td data-bbox="1252 1413 1356 1478">5</td></tr><tr><td data-bbox="646 1478 798 1666"></td><td data-bbox="798 1478 949 1666"></td><td data-bbox="949 1478 1101 1666"></td><td data-bbox="1101 1478 1252 1666"></td><td data-bbox="1252 1478 1356 1666"></td></tr></table>	1	2	3	4	5					
1	2	3	4	5							

6.4 PTZ (Only TX-67)

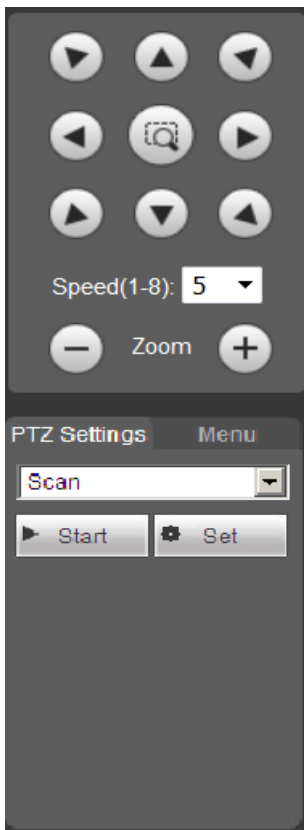

Change the direction of the Camera with pressing the button shown at the left side. The speed of the camera can be set between 1-8. Under PTZ the camera can be Zoom In or Zoom Out!

PTZ Settings: there are 2 options to set (Preset & Tour).

Preset & Tour: Click on the dropdown menu to select between the Preset & Tour. You have an option to set between 1 to 25 Preset or Tour.

1.  Fast positioning button: Use your mouse to select a zone in the monitor window, PTZ can fast rotate and focus to current position.
2. Speed operation: The larger the value is, the faster the speed is. This is for PTZ direction control, zoom, focus and aperture.
3. PTZ setting (Go to Setup→ PTZ→ Function): Call the preset configuration for scan, pattern, tour, preset.

(Preset: Use direction keys to move the camera to your desired location and then input preset value. Click "Add" button, you have set one preset. Repeat this step to add more preset positions.

Tour: Input tour value and then click the "Add" button, you have set one tour. Then input preset value in the column. Click "Add Preset" button, you have added one preset in the tour. Or you can click "Del Preset" button to remove one preset from the tour.)

Note: Repeat the above procedures you can add or delete more presets in one tour.

To set the following functions click on Setup → PTZ → Function.

In the Live picture you can select scan, preset, tour, pattern, assistant function, to start or stop the selected function. See figure 6-4.

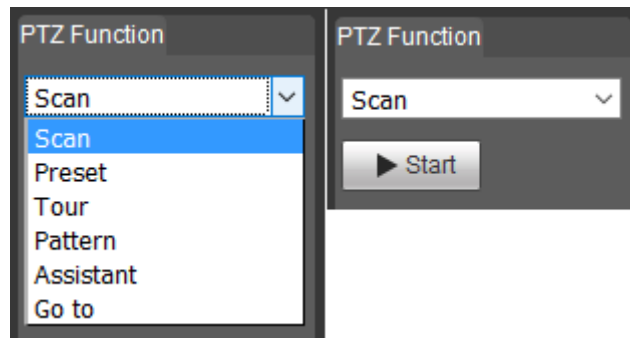

Figure 6-4

6.5 Playback (Only when MicroSD Card is inserted)

Wait a moment to let the web plug-in load the recorded videos from the Micro SD-card of the camera.

Attention: If there is no MicroSD-card installed, videos and pictures can't be taken.



Play - This button means play or pause.



Stop – With this button stop the playback.



Next frame – Click it to go to watch the video frame by frame.



Slow play – Click it to lower the play speed (1/2x, 1/4x, 1/8x, 1/16x).



Fast play - Click it to speed up the play speed (2x, 4x, 6x, 8x).



Quiet / Sound – Mute or turn on the sound of the audio of the recorded video with these button.



Increase or decrease the system volume.



Digital zoom - Click it, to activate the function (6.3 Live / Digital Zoom).



Snapshot - Click it, to take a picture of the recorded video you are watching.

File Type: Switch between picture (jpg) and video (dav) files.

Data Src: Pick SD- card, this is where the recorded files are saved.

Calendar: Pick the date which you would like to view the recorded files. The blue dates show you when the camera has recorded pictures/videos.

By clicking the button under the calendar you are going to see the menu below.

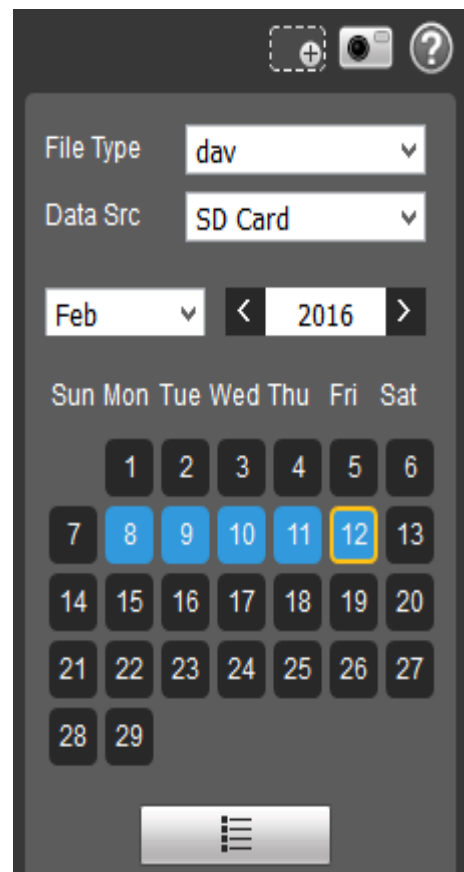

Time: Choose the time of the day to see the recorded videos.

Download Format: Choose mp4, it is possible to view this video format with different common players.

Start Time: Shows when the recording started (time red = selected video and time blue = video is played).

File Type: Shows how the video was started/triggered (yellow = motion, red = alarm and blue = manual). Start the download press .

Stop the download press .

File Size: shows the size of the video file. By clicking the button with the arrow you are going back to the calendar menu.

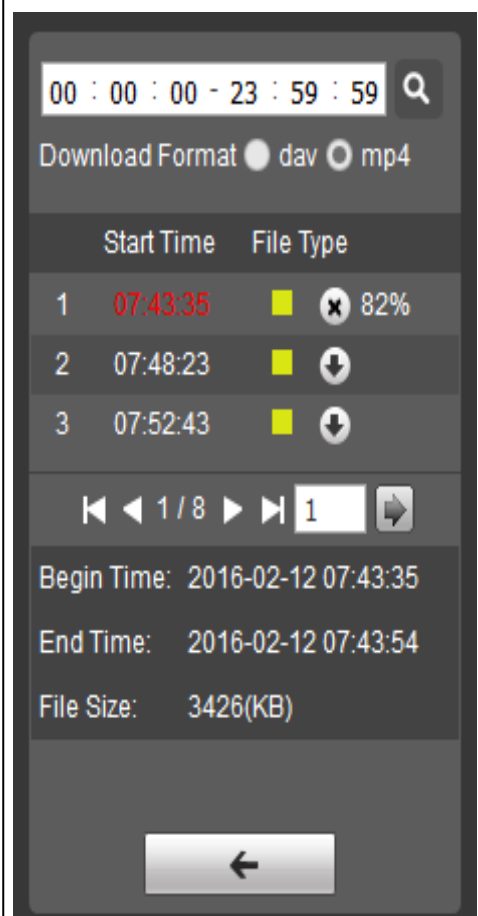

	1	2	3	4	5
Record Type	<input checked="" type="checkbox"/> All	<input checked="" type="checkbox"/> General ■	<input checked="" type="checkbox"/> Motion ■	<input checked="" type="checkbox"/> Alarm ■	<input checked="" type="checkbox"/> Manual ■

1. All: Recording will be for General, Motion, Alarm and Manual
 2. General: Always recording
 3. Motion: Recording when motion detected
 4. Alarm: Recording when alarm enabled
 5. Manual: User defined (Live recording)

1	2	3	4
			

1. 24hr: Shows the whole day in 2h segments.
 2. 2hr: Shows 1h before and 1h after the curser set
 3. 1hr: Shows 30min before and 30min after the curser set
 4. 30min: Shows 15min before and 15min after the curser set

6.6 Setup

6.6.1 Camera

6.6.1.1 Conditions

A: Conditions

You can select the following profile types: normal, day or night.

After you selected the mode, you can set brightness, contrast, saturation, sharpness, anti-flicker, day & night, d & n sensitivity, d & n Delay, BLC mode, mirror, flip, 3D NR and 3D NR level for each profile.

After you changed the setup or only one parameter you have to click on save, to apply the changes constantly.

By clicking on default the changes you made are deleted and the parameters are back on default settings.

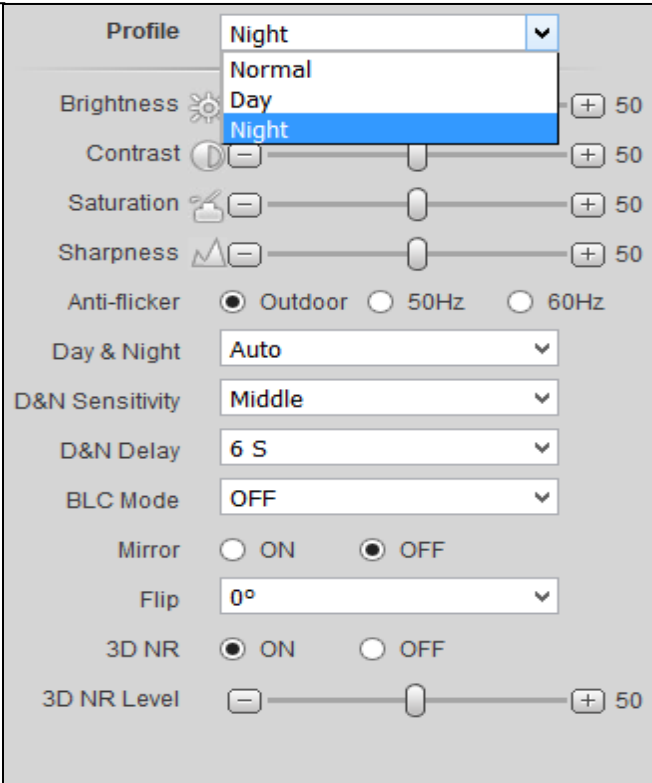

Only TX-65 & TX-66

White balance (WB) function:
Auto, Natura, Street Lamp, Outdoor, Manual

IR-light function:

- Manual, SmartIR, OFF

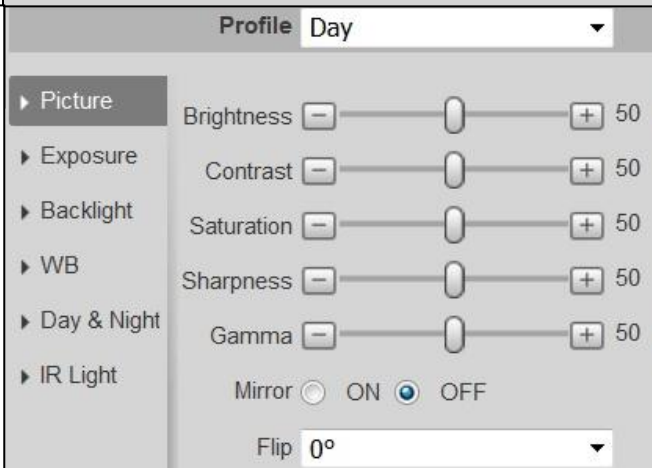

B: Profile management: It works with the profiles select for normal, day and night under 6.6.1.1.1 conditions. The default setting here is **full time/day**. But also choose normal or schedule. If the setting **full time** is activated choose between the configuration of day or night. The here selected profile type is always enabled. When **schedule** is activated select how long the day and the night profile are working.

6.6.1.2 Video

A: Video

The System supports active control frame function (ACF). It allows you to record in different frame rates. For example, use high frame rate to record important events and it allows you to set different frame rates for motion detection record and alarm record. It includes general stream, motion detect stream and alarm stream. Select different encode frame rates form different recorded events.

B: Snapshot

Select between “General or Event snapshot”. General snapshot is to snap during the specified period. Event snapshot is to snap after motion detect, camera masking or local alarm occurred. Set the image quality and snapshot interval.

Snapshot can become active once you setup the following items:

1. the action is in the specified period.
2. the motion detect, camera masking or local alarm and their snapshot functions are enabled.

C: Overlay

Set the privacy masking: Channel title, time title and text overlay. After you successfully set and saved the privacy mask zone, channel title, and time title, click the refresh button to see the effect.

Under TX-65, TX-66 &TX-67 also add text overlay.

D: Path

Set the path to save the file from live snapshot, live record, playback snapshot, playback download & video clips on your current PC.

Playback snapshot, playback download & video clips are only supported when MicroSD Card is inserted.

6.6.2 Intelligent Video Surveillance (IVS) (only for TX-67)

6.6.2.1 Global Setup

The global setup interface is shown as in Figure 6-

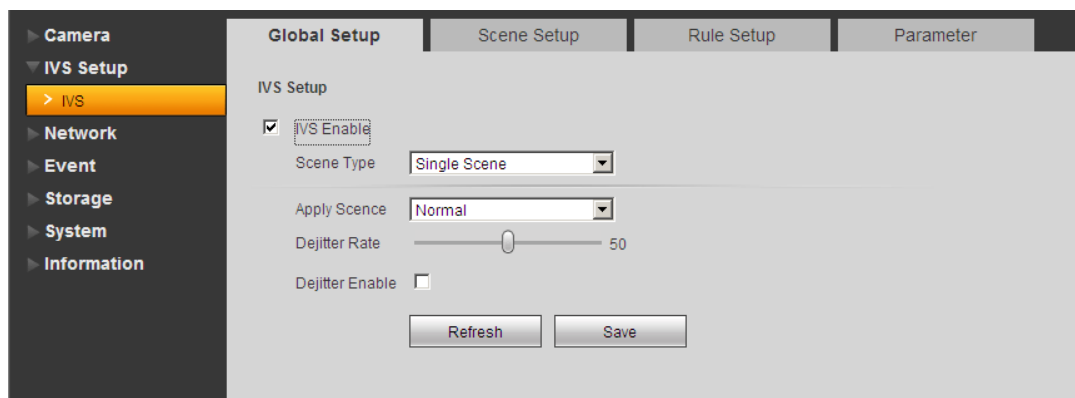

Figure 6-5

Parameter	Function
IVS enable	Check the box here to enable IVS function.
Scene type	It includes: panorama (optional, single scene and multiple-scene. <ul style="list-style-type: none"> • (Panorama: Realize the intelligent analytics of current monitor video after you enabled the preview function.) • Single scene: Realize the intelligent analytics of one scene. • Multiple-scene: It is to realize the intelligent analytics of several scenes and the scenes support tour function.
Apply scene	The default setup is normal.
De-jitter	Here you can set device de-jitter rate.
De-jitter enable	Check the box here to enable de-jitter module.

6.6.2.2 Scene Setup

The scene setup is shown as in Figure 6-6.

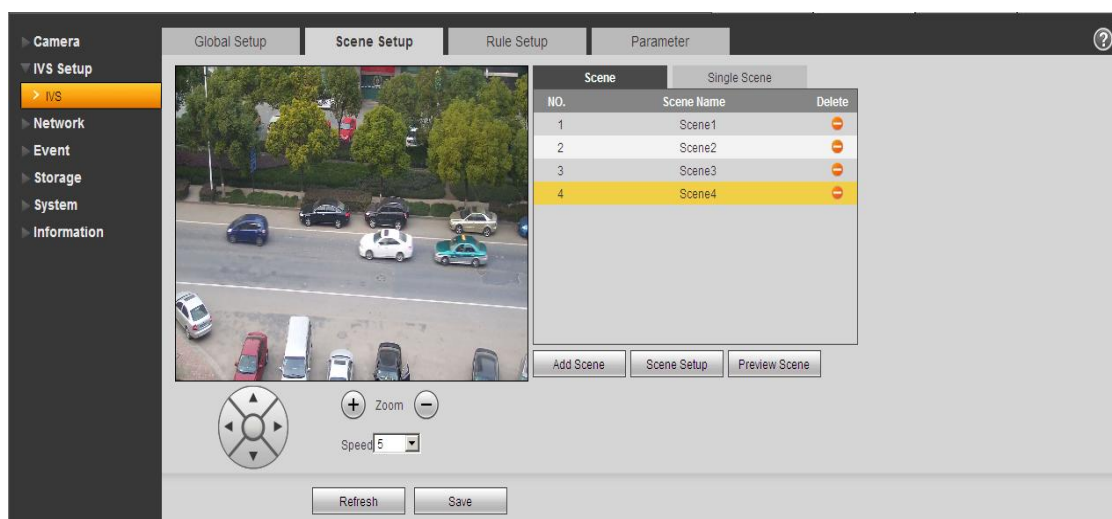





Figure 6-6

Parameter	Function
Add scene	Click it to add a scene.
Scene setup	Click it to set current monitor video as the corresponding scene and get a number.
Preview scene	Click it to preview the selected scene.
Zoom	Click  to zoom in and click  to zoom out.
PTZ	Click PTZ button  to adjust scene position.
Speed	It is to set PTZ movement speed. The value ranges from 1 to 8.

6.6.2.2.1 Single Scene

In Figure 6-, select the single scene from the scene type list, you can see the single scene interface is shown as in Figure 6-7. Here you can select one item from the No. list to view one monitor scene.

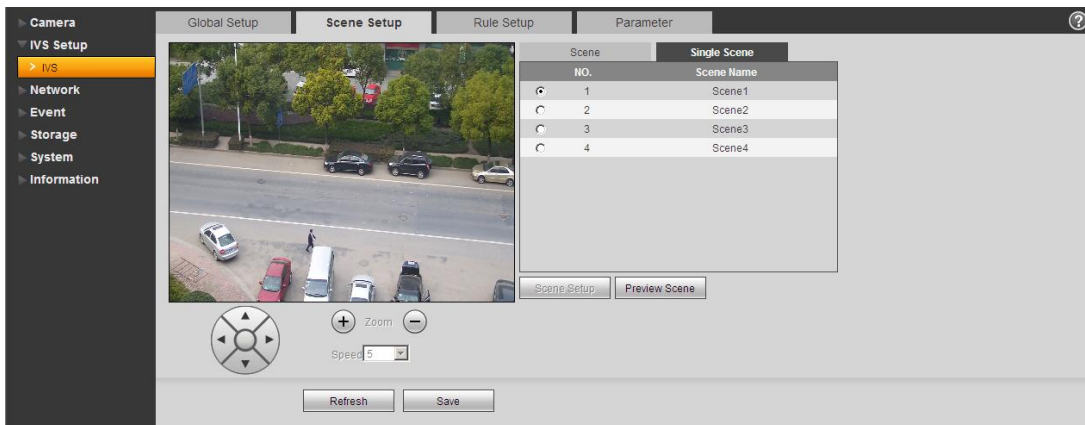

Figure 6-7

6.6.2.2.2 Multiple-scene track

In Figure 6-, select the Multiple-scene from the scene type list.

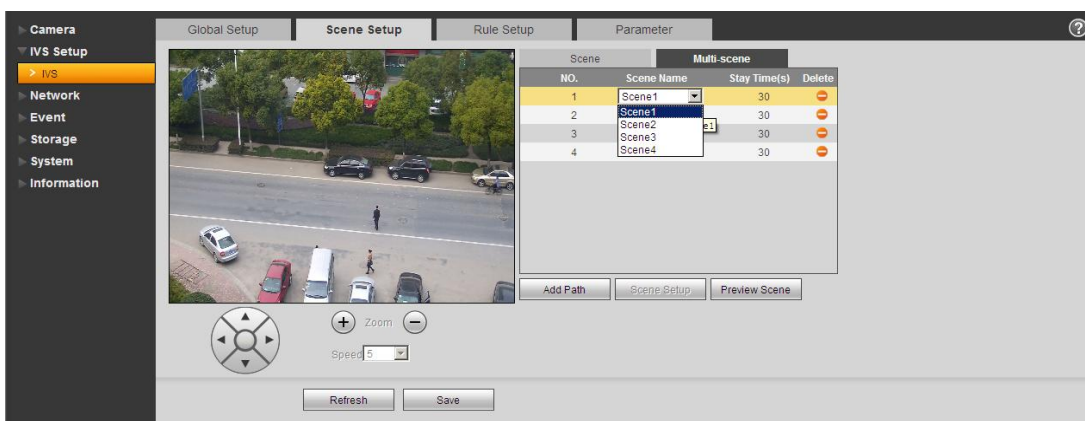

Figure 6-8

In Figure 6-8, click Add scene button you can set tour point during the scene tour process. Move the mouse to the Scene name list; you can select several scenes as a tour. Move the mouse to the Stay time, you can set stay time period.

6.6.2.3 Rule Setup

The rule setup interface is shown as in Figure 6-7.

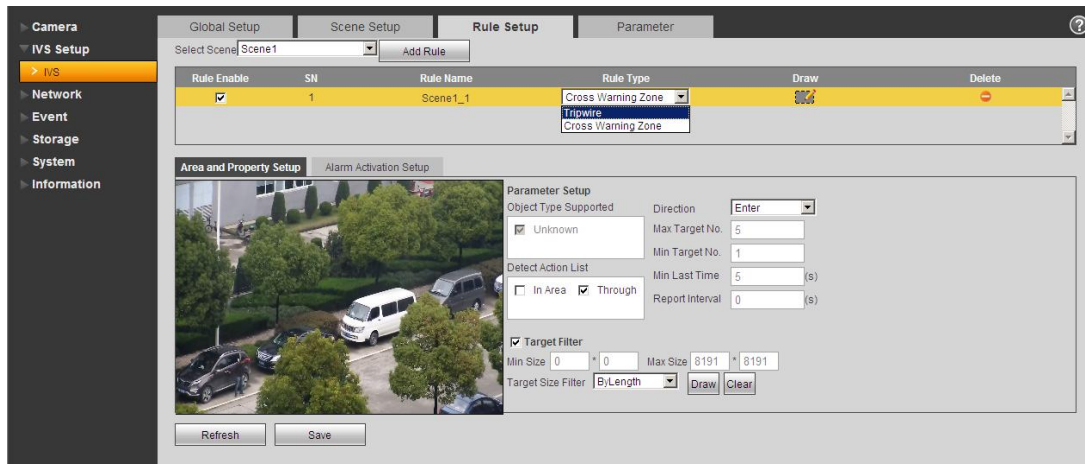



Figure 6-7

Parameter	Function
Select scene.	You can select the scene from the dropdown list so that you can add the corresponding rule.
Add rule	Click it to add a rule to the selected scene.
Rule enable	Check the box here to enable the rule.
Rule name	Move you mouse to the rule name column to set a name.
Rule type	Move you mouse to the Rule type column to set the rule type. The option includes: Tripwire, Intrusion, Abondend, Missing object detection.
Draw rule	Click button  to draw current rule.
Delete rule	Click button  to delete current rule.

6.6.2.3.1 Tripwire

The tripwire interface is shown as in Figure 6-88.

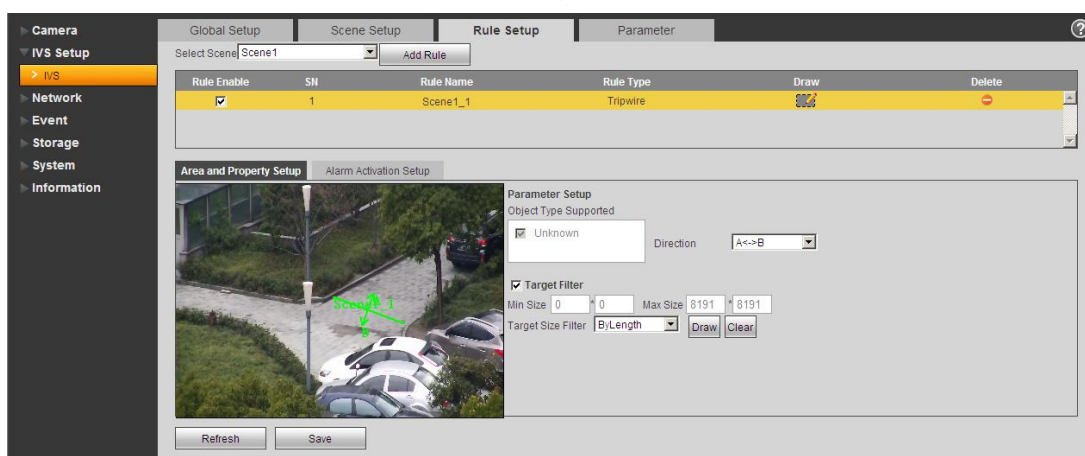



Figure 6-8

Parameter	Function
Object type supported	You can select an object type here. The default setup is Unknown.
Direction	It is to set tripwire direction. The option includes: A->B、 B->A、 A<->B.
Target filter	Check the box here to enable this function and then click button  , you can set the target filter model in this scene for this rule. Click the button  , you can remove selected target filter model.

6.6.2.3.2 Cross Warning Zone

The cross warning zone interface is shown as in Figure 6-9.

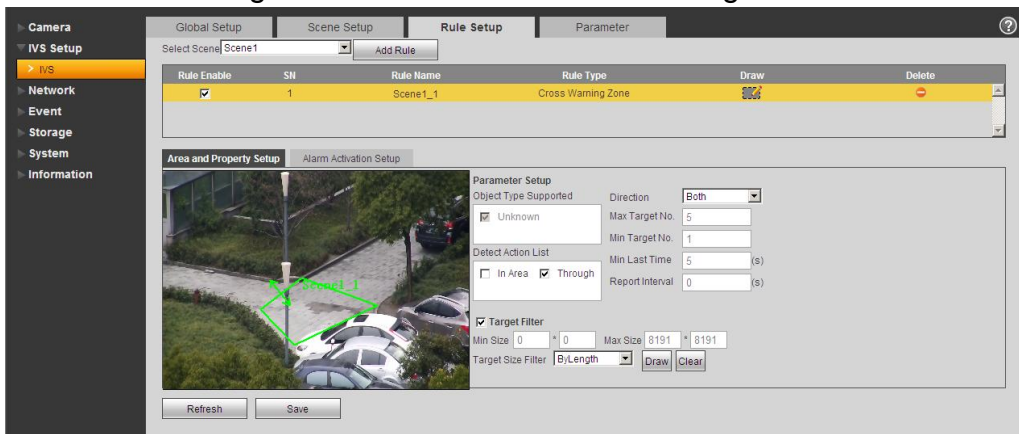



Figure 6-9

Parameter	Function
Object type supported	You can select an object type here. The default setup is Unknown.
Detect action list	<ul style="list-style-type: none"> In area: When the tracking object is in the detect zone and the stay time is more than the time threshold you set here, system can activate an alarm. Through area: System can generate an alarm when the tracking object is crossing the limit you set here.
Direction	It is for the Through area option in the Detect action list item. It is to set the cross direction. The option includes: enter/leave/enter&leave
Max target No.	It is for the In area option in the Detect action list item. It is to set the alarm activation amount in the zone. System will not generate an alarm when the object amount in the zone is more than the threshold you set here.
Min target No.	It is for the In area option in the Detect action list item. It is to set the alarm activation amount in the zone. System will not generate an alarm when the object amount in the zone is less than the threshold you set here.

Parameter	Function
Min last time	It is for the In area option in the Detect action list item. Here is to set the min time between the target in the zone and an alarm activation occurrence.
Report interval	It is for the In area option in the Detect action list item. It is to set alarm period. System just alarms once if the value is 0 here.
Target filter	Check the box here to enable this function and then click button  , you can set the target filter model in this scene. Click the button  , you can remove selected target filter model.

6.6.2.3.3 Alarm Activation Setup

Alarm activation setup is shown as in Figure 6-10.

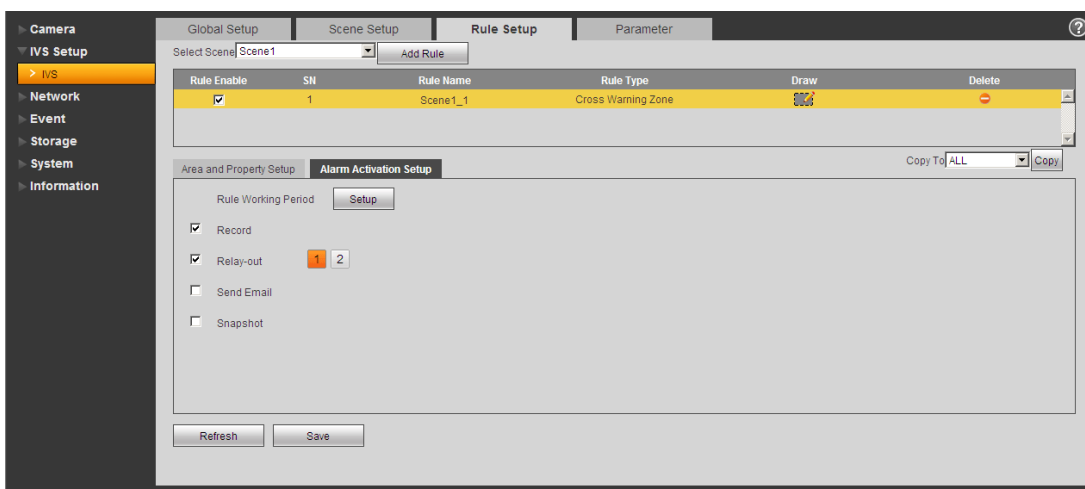



Figure 6-10

Parameter	Function
Rule Working period	Here you can set rule arm and disarm period. Please click the Setup button to set.
Record	Check the box here so that the device can record when alarm activation occurred.
Send e-mail	<ul style="list-style-type: none"> • Check the box here so that the device can send out an email when alarm activation occurred. • Please note current function is null when the device is offline, or IP conflict occurred.
Snapshot	Check the box here so that the device can snapshot when alarm activation occurred.
Copy	Select a rule name from the dropdown list and then click  button; you can copy the alarm activation setup of current rule to the selected rule.

6.6.2.4 Parameter

The parameter interface is shown as in Figure 6-11.

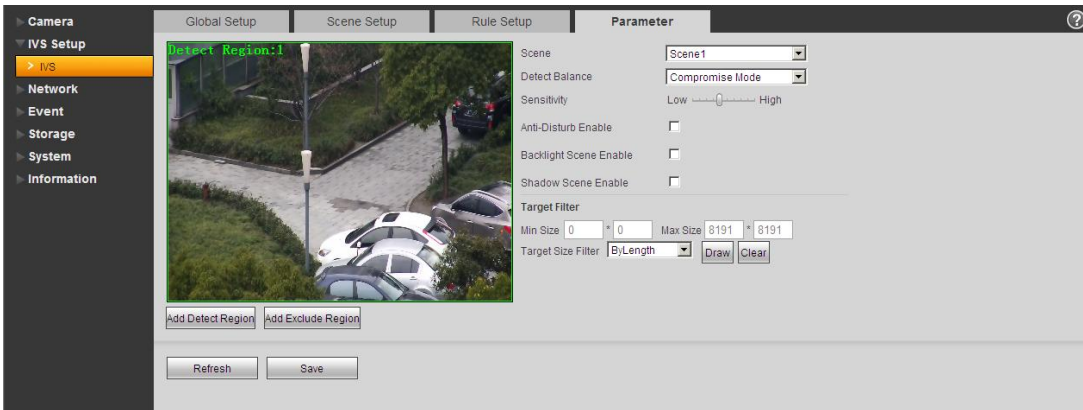



Figure 6-11

Parameter	Function
Scene	Please select a scene from the dropdown list you want to set.
Detect balance	There are three modes: compromise mode, omission detect less and error detect less.
Sensitivity	The level ranges from 1 to 10. The default setup is 5. The higher the sensitivity is, the easier for the device to detect the low contrast object and small object. At the same time, the error detect may become more.
Add detect region	Click button  , you can draw a detection zone.
Add excluded region	Click button  , you can draw the privacy mask (shield) zone.

6.6.3 Network

6.6.3.1 TCP/IP

A: TCP/IP

TCP/IP mode is to set device login IP. It supports IPv4 and IPv6. IPv4 supports static IP and DHCP, IPv6 only supports static IP. After you set the IP address manually, Web interface can automatically go to the login interface of the new IP.

B: P2P/Easy4ip

If P2P/Easy4ip is enabled and the camera is configured over LAN/WiFi, it is possible to connect the camera via the P2P function of the My Secure Pro app.

6.6.3.2 Connection

A: Connection

Max Connection	It is the max Web connection for the same device. The value ranges from 1 to 20. The max connection amount is 20.
TCP port	TCP protocol communication service port. The value ranges from 1025 to 65534.
UDP port	User data packet protocol port. The value ranges from 1025 to 65534.
HTTP port	HTTP communication port. The value ranges from 1025 to 65534
RTSP	<ul style="list-style-type: none"> ■ The default value is 554. Use the following format to play if you are using Apple browser QuickTime or VLC. The Blackberry phone also supports this function. ■ Real-time monitor bit stream URL format. You need to input the channel name, bit stream type in the URL when you are querying the real-time monitor bit stream RTSP stream media service. You need to input the user name and password if you want the verification information. ■ If you are using the blackberry phone to play the video. The stream encode mode shall be H.264B, resolution is CIF and disable the audio. Refer to the following contents for URL format information : rtsp://username:password@ip:port/cam/realmonitor?channel=1&subtype=0 Among which: Username: such as admin Password: such as admin IP: IP address such as 10.7.8.122 Port: Default value is 554. Leave it in blank. Channel: Channel number begins with 1. The second channel is shown as channel=2 Subtype: Bit stream type. The main stream is 0 (subtype=0) . The extra stream is 1 (subtype=1) . If you want to query the extra stream of the channel 2.The URL is shown as below: rtsp://admin:admin@10.12.4.84:554/cam/realmonitor?channel=2&subtype=1 You do not need to input the user name and password if you do not need to the verification. Such as: rtsp://ip:port/cam/realmonitor?channel=1&subtype=0
HTTPs On	HTTPs communication service control. When HTTPs is on, use https://ip:port to login the device. The data has encryption. Use https://ip to login if you are using default port.
HTTPs port	HTTPs communication port. The value ranges from 1025~65534.

Note:

1. Do not use the port value such as 0-1024, 37780-37880, 1900, 3800, 5000, 5050, 9999, 37776, 39999 and 42323 since they are used as the special port.
2. When setting the port value, it's not recommended to use other ports' default port value.

B: PPPoE (Only TX-67)

PPPoE is to set a connection to the Internet with the account you get from the ISP. View the IP address in the TCP/IP option if your setup is proper.

C: DDNS

The DDNS is to set to connect the various servers so that access the system via the server. Go to the corresponding service website to apply a domain name and then access the system via the domain. It works when also your IP address has changed

D: IP Filter

Trusted Sites: Only the IP listed below can login the device. Once you check the Trusted Sites function, only the IP listed in the trusted sites list can login the specified device. All the users can login the device if you do not check the trusted sites box here. The device IP cannot list in the trusted list.

The MAC verification can only be valid when the device IP and the PC IP are in the same IP segment.

E: SMTP (Email)

Fill in all the needed Information. You find them by searching your e-mail provider.

This function allows the system to automatically send out the test information to check the email connection is proper or not. You need to check the box here to enable this function and set the update period.

F: UPnP

Use the UPnP protocol to establish a forwarding relationship. The camera port is the internal port and the router port is the external port. Access the external port to visit the IP camera.

G: SNMP (Only TX-67)

SNMP is an abbreviation of Simple Network Management Protocol. It provides the basic network management frame of the network management system. The SNMP widely used in many environments. It is used in many network device, software and system.

Enable the SNMP function. Use the corresponding software tool (MIB Builder and MG-SOFT MIB Browser. You still need two MIB file: BASE-SNMP-MIB, DVR-SNMP-MIB) to connect to the device. Get the device corresponding configuration information after successfully connection. Follow the steps listed below to configure.

- Check the box to enable the SNMP function. Input the IP address of the PC than is running the software in the Trap address. Use default setup for the rest items.
- Compile the above mentioned two MIB file via the software MIB Builder.
- Run MG-SOFT MIB Browser to load the file from the previous step to the software.
- Input the device IP you want to manage in the MG-SOFT MIB Browser. Set the corresponding version for your future reference.
- Open the tree list on the MG-SOFT MIB Browser; get the device configuration. See how many video channels, audio channels, application version and etc. the device has.

Note: Port conflict occurs when SNMP port and Trap port are the same.

H: Bonjour

After you enabled the Bonjour function, the OS or the client-end that supports the Bonjour function can automatically detect the IP camera. View the server name when the IPC is detected by the Bonjour. Note the Safari browse support this function. Click the “Display All Bookmarks: and open the Bonjour, system can auto detect the IPC of the Bonjour function in the LAN.

I: Multicast

Multicast is a transmission mode of data package. When there is multiple-host to receive the same data packet, multiple-cast is the best option to reduce the broad width and the CPU load. The source host can just send out one data to transit. This function also depends on the relationship of the group member and group of the outer. For detail information refer the help file on web interface!

J: WIFI

J.A: WIFI

Check the box to enable WIFI function and then click the Search SSID button. Now you can view all the wireless network hotspot information in a list. Click on the SSID of your choice. See the signal quality and the authentication mode. Note sometimes you need to input the password. For detail information refer to the help file!

J.B: WPS (only TX-65 & TX-66)

To connect the camera via WPS you have to enter the Pin and the SSID of your router. Find these information's in the configuration of the router.

You also can connect the camera with the router by pressing the Network button on the camera and the WPS button at your router.

K: 802.1x (Only TX-67)

802.1x works standing for local and metropolitan area networks and port based network access control protocol. It supports manual operation of the client to choose means of authenticating by which to control it to access to the Local Area Networks or not. It supports the ability to authenticate, to calculate fee, to ensure security and to maintain requirements.

L: QoS

DSCP priority has 64(0-63) levels. It marks the different priorities of the packets. Level 0 has the lowest priority and level 63rd has the highest priority. It can select the different queues according to the priorities of the packets and select the bandwidth of each queue. It can also discard at the different ratio when the broad bandwidth is jam.

6.6.4 PTZ

The PTZ interface is shown in Figure 6-12. Here you can adjust and set Preset, Tour, Scan, Pattern, PTZ Speed, etc.

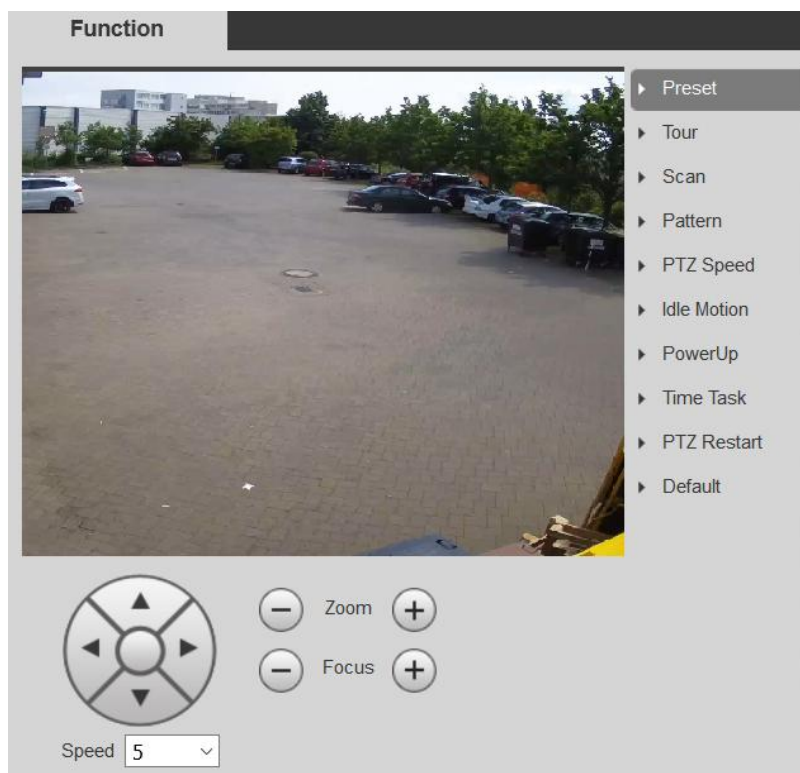

Figure 6-12

Parameter	Function
Preset	<ul style="list-style-type: none"> ● Select Preset, input the preset value and then click Add button, now system save current position as one preset. Click View button, the camera turns to the corresponding position of the preset.
Tour	<ul style="list-style-type: none"> ● Select Tour and then input tour value. Click Add or Delete button to add/remove one preset from the tour. Click Start button, you can begin tour.
Scan	<ul style="list-style-type: none"> ● Select Scan, click Set button and then control the PTZ to set the scan left limit and right limit. Start button, you can begin scan operation.
Pattern	<ul style="list-style-type: none"> ● You can select Pattern and then click Add button, now you can operate PTZ to realize zoom, focus, iris, direction operation and etc. Click Stop button to stop memory pattern process. Click Start button to begin PTZ movement.
PTZ Speed	<ul style="list-style-type: none"> ● Here you can set camera PTZ speed (Low, middle, high).
Idle Motion	<ul style="list-style-type: none"> ● It is a motion that is interrupted by a pause you can set. ● Check the box here to enable idle motion function. You can set the idle Motion function for preset, scan, pattern, tour. ● Attention: Note you need to set the corresponding function first if you want to use it.
Power Up	<ul style="list-style-type: none"> ● Check the box here to enable power up function. You can set the power up function for preset, scan, pattern, tour and auto. ● Attention: Note you need to set the corresponding function first if you want to use it.
Time Task	<ul style="list-style-type: none"> ● Check the box here to enable time task function. You can set the time task function for preset, scan, pattern, tour and auto. ● You can set the period and you can copy the option to other Task No. ● Attention: Note you need to set the corresponding function first if you want to use it.
PTZ Restart	<ul style="list-style-type: none"> ● It is to reboot PTZ.
Default	<ul style="list-style-type: none"> ● Restore PTZ factory default setup.

6.6.5 Event

6.6.5.1 Video Detect

A: Motion Detect

Tip: Set the sensitivity and the threshold under region in order to get an alarm when the detected moving signal reached the threshold you set in the device.

- Enable: Check the box here to enable motion detect function.
- Working Period: Click the setup button. Set motion detect period here. System only enables motion detect operation in the specified periods. It is not for video loss or the tampering. There are two ways for you to set periods. Note: System only supports 6 periods in one day. Select the period you want to set with the mouse. With the "Setup" button select the working period for the day. Check "All" for the whole week. For each period you can set the start time and the end time. Save the settings after changing.
- Anti-dither: Set anti-dither time here. The value ranges from 0 to 100s. The anti-dither time refers to the alarm signal detected lastly. During the alarm process, the alarm signal can begin an anti-dither time if system detects the local alarm again. For example, if you set the anti-dither time as 10 second, you can see that each activation may last 10s if the local alarm is activated. During the process, if system detects another local alarm signal at the fifth second, the buzzer, tour, PTZ activation, snapshot, record channel will begin another 10s while the screen prompt, alarm upload, email will not be activated again. After 10s, if system detects another alarm signal, it can generate an alarm since the anti-dither time is out.
- Area:

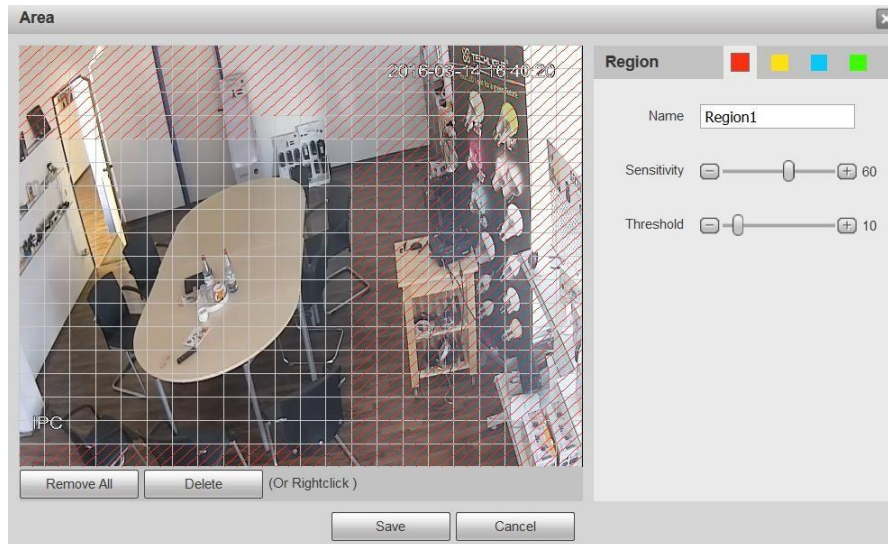

Click setup button. Set motion detection regions here. There are four regions for you to set (red, yellow, blue and green). Select one of the colored regions first. Then click the left mouse button on the start point of the area you want to select and drag the mouse to select the area. In the test area the best setting for sensitivity and threshold is 60 and 10 respectively. Depending on your given environment this settings can be vary. Sensitivity and threshold can be set in the range from 0 to 100. The higher the sensitivity and the lower the threshold are set the more motion is detected. For example: When a leaf falls or a cat is running in the selected area a motion will be detected.

In this case a subjective setting by the customer is requested!

The corresponding colored area displays different detection areas. After you completed the setup remember to click the save button to save current setup. If you click ESC button to exit the region setup interface system will not save your zone setup.

- Record: Check the Box here, system auto activates motion detection channel(s) to record once an alarm occurs.
- Record Delay: System can delay the record for specified time after alarm ended. The value ranges from 10s to 300s.
- Send email: Check the Box here, system can send out email to alert you when an alarm occurs.
- PTZ (Only TX-67): Check the Box here, to set PTZ movement here when an alarm occurs. Such as go to preset, tour & pattern when there is an alarm.
- Snapshot: Enable this function to snapshot image when a motion detect alarm occurs.

For detail information refer the help file.

B: Video Tamper

You need to check the box here to realize the video tamper alarm.

- Enable: Check the box here to enable video tamper function.
- Working Period: Check the box here and click the setup button. Set motion detect period here. System only enables motion detect operation in the specified periods. It is not for video loss or the tampering. There are two ways for you to set periods. Note system only supports 6 periods in one day. Select the period you want to set with the mouse. With the "Setup" button select the working period for the day. Check "All" for the whole week. For each period set the start time and the end time. Save the settings after changing.

- Record: Check the box here, system auto activates motion detection channel(s) to record once an alarm occurs.
 - Record Delay: System can delay the record for specified time after alarm ended. The value ranges from 10s to 300s.
 - Send email: Check the box here, system can send out email to alert you when an alarm occurs.
 - PTZ (Only TX-67): Set PTZ movement here when an alarm occurs. Such as go to preset, tour & pattern when there is an alarm.
 - Snapshot: Enable this function to snapshot image when a motion detect alarm occurs.
- For detail information refer the help file.

6.6.5.2 Abnormality

A: MicroSD Card (only when MicroSD Card is inserted)

Enable: Check the box here to enable abnormality of MicroSD Card.

It includes the status: No MicroSD card, MicroSD card error and capacity warning.

Check "Send Email" to get an event via Email.

B: Network

Enable: Check the box here to enable abnormality of Network.

It includes the status: Disconnection and IP conflict. Check "Record" to get an event recorded.

Record Delay: System can delay the record for specified time after alarm ended. The value ranges from 10s to 300s.

C: Illegal Access

Enable: Check the box here to enable abnormality of Illegal Access.

Under "Login Error" set the amount of unauthorized access (3-10 times).

Check "Send Email" to get an event via Email.

6.6.6 Storage

6.6.6.1 Schedule

In the schedule interface, you can add/remove three types of record plan or snapshot plan. There are six periods in one day. System cannot enable the record function in the specified period if the record function is disabled in the record control interface. View the current time period setup from the color bar.

A: Record Schedule

Check the box for general (green), motion (yellow) or alarm (red).

Set record schedule here. System only enables record option in the specified periods. There are two ways for you to set periods. Note system only supports 6 periods in one day. Select the period you want to set with the mouse. With the "Setup" button select the record schedule for the day. Check "All" for the whole week. For each period you can set the start time and the end time. Also it is possible to check the box for general (green), motion (yellow) or alarm (red). Save the settings after changing.

B: Snapshot Schedule

Check the box for general (green), motion (yellow) or alarm (red).

Set snapshot schedule here. System only enables record option in the specified periods. There are two ways for you to set periods. Note system only supports 6 periods in one day. Select the period you want to set with the mouse. With the "Setup" button select the snapshot schedule for the day. Also you can check "All" for the whole week. For each period you can set the start time and the end time. Also it is possible to check the box for general (green), motion (yellow) or alarm (red). Save the settings after changing.

C: Holiday Schedule

Check the box for general (green), motion (yellow) or alarm (red).

Set holiday schedule here. System only enables record option in the specified periods. There are two ways for you to set periods. Note system only supports 6 periods in one day. Select the period you want to set with the mouse. With the "Setup" button select the holiday schedule for the day. Also you can check "All" for the whole week. For each period you can set the start time and the end time. Also it is possible to check the box for general (green), motion (yellow) or alarm (red). Save the settings after changing.

6.6.6.2 Destination

A: Path

Check the box here to storage the corresponding record or snapshot picture. There is local MicroSD card, FTP or NAS storage setup for you to choose. Save the settings.

B: MicroSD card (Local)

Under local you can see:

- Device name: The name given to the MicroSd card slot.
- Status: Status of the storage device (MicroSD card).
- Attribute: Set the option for the MicroSD card read only or read & write.
- Used / Total Capacity: See the used and toal space of the MicroSD card in MB.
- Format: Click this button to format the MicroSD card. This will delete all saved files on the MicroSD card.

C: FTP

First enable the check box for FTP under Path. Check the box to enable the FTP-server.

- Server Address: Enter the server address of the FTP-server
- Port: Server port of the FTP-server (0-65535)
- User Name: Optional
- Password: This can be empty when no user name is given.
- Remote Directory: This is the directory where the recorded files will be saved.
- Emergency (Local): In case FTP-server is not working the recorded files will be saved local (MicroSD card).

D: NAS

First enable the check box for NAS under Path. Check the box to enable the NAS-server.

- Server Address: Enter the server address of the NAS-server
- Remote Directory: This is the directory where the recorded files will be saved.

6.6.6.3 Record control

Select Auto/Manual/Off mode. Manual mode is to begin record and auto mode is to record in the specified period.

- Pack Duration: Defines the length of the file to be recorded (1-120 minutes).
- Pre-event Record: The time before the event is going to be recorded (0-5 seconds).
- Disk Full: When the MicroSD card is full then the system will stop or overwrite the recording.
- Record Stream: Choose between Main or Sub Stream.

6.6.7 System

6.6.7.1 General

The General interface includes General and Date & Time

A: General

- Device name: Device name will be set as default automatically. This can be changed manually.
- Language: Select the language from the dropdown list. Note the device needs to reboot to get the modification activated.
- Video standard: This is to display video standard such as PAL.

Status Light Switch: Set the status light of the camera off or on (Only TX-65 & TX-66).

B: Date & Time

- Date format: Select date format from the dropdown list.
- Time Format: There are two options: 24-H and 12-H.
- Time Zone: The time zone of the device.
- Current time: Click the Sync PC button to save the system time as your PC current time.
- DST: Check the box to enable. Set day night save time start time and end time. Set date format or the week format.
- Synchronize with NTP: Check the box to enable NTP function.
- NTP server: Set the time server address. Default clock.isc.org.
- Port: It is to set the time server port. Default 123.
- Update Period: It is to set the sync periods between the device and the time server. Default 10 (0-30 minutes).

6.6.7.2. Account

Enable anonymous login and input IP, login the device without user name or password. The anonymous login user can only have the preview rights in the authority list. Under anonymous login mode, click logout and login the device via other account.

To add a User/Group Press the button "Add User" or "Add Group"

- User/ Group name: For the character in the following user name or the user group name, system max supports 6-digits. The space in the front or at the end of the string is null. The valid string includes: character, number, and underline.
- Modify: It is to modify the user property, belonging group, password and rights.
- Delete: Press Delete icon to delete User/Group.

Note:

- The user amount default setup is 64 and the group amount default setup is 20. The factory default setup includes two levels: user and admin. Set the corresponding group and then set the rights for the respective user in the specified groups.
- User management adopts group/user modes. The user name and the group name shall be unique. One user shall be included in only one group.
- There are four default users: **admin/888888** and hidden user “**default**”.
- Hidden user “**default**” is for system interior use only and can't be deleted. When there is no login user, hidden user “default” automatically login. Set some rights such as monitor for this user so that you can view some channel view without login. Input the user name and password and then select one group for current user.
- Note the user rights shall not exceed the group right setup.
- For convenient setup, make sure the general user has the lower rights setup than the admin

6.6.7.3. Default

Click the Default button to reset all configurations.

Note: Note system cannot restore some information such as network IP address, account and so on.

6.6.7.4. Import / Export

Import the local setup files to the system or export the corresponding system setup to your local PC.

6.6.7.5. Auto Maintain

Select auto reboot and auto delete old files interval from the dropdown list. If you want to use the auto delete old files function, you need to set the file period.

6.6.7.6. Upgrade

1. Click “Browse” button to select the upgrade file.
2. Click the “Upgrade” button to upgrade the firmware.

Note:

- The extension name of the upgrade file shall be *.bin.
- During the upgrade process, do not disconnect the power cable, network cable or shutdown the IPC.
- Reboot the device if you update the error file. Otherwise some module function may be disabled.

6.6.8. Information

6.6.8.1 Version

View software version with release date, Web Version, ONVIF Version, Serial number of the device and the Copyright.

6.6.8.2 Log

- Type: All, system, Setting, Data, Event, Record, account and Clear Log.
- Start time: Set the start time of the requested log.
- End time: Set the end time of the requested log.
- Search: Select log type from the drop down list and then click search button to view the list. Click the stop button to terminate current search operation.
- Detailed information: Select one item to view the detailed information.
- Clear: Click this button to delete all displayed log files.
Note: system does not support clear by type.
- Backup: Click this button to backup log files to current PC.

6.6.8.3 Online User

These shows the users who are currently connected to the camera

7. Alarm

Set device Alarm Type, Operation and Alarm Tone (Make sure you have enabled audio function of corresponding alarm events.).

Alarm Type:

- Motion detection System alarms when motion detection alarm occurs.
- Disk full: System alarms when disk is full.
- Disk error: System alarms when disk error occurs.
- Video Tamper: System alarms when camera is viciously masking.
- Illegal Access: System alarms when the login was wrong for the set amount.

Operation:

- Prompt: Check the box here, system automatically pops up an alarm icon on the right side in the Alarm interface when there is an alarm.
- Alarm Tone:
- Play Alarm Tone: Check the box here, system sends out alarm sound when an alarm occurs.
- Tone Path: Specify alarm sound file and the tone (use WAV File).

8. Logout

Click Logout button, system goes back to login interface. You need to input user name and password to login again.

9. App Overview (My Secure Pro)

9.1 General Introduction

This manual is designed for smartphone to perform monitoring function. It is built on traits of mobile device to include functions of multiple touch control, touch signal recognition, alarm push, P2P function, DDNS analysis and etc. User can preview, control PTZ, play video and etc. from front-end camera, Receiver under WIFI environments.

9.2 Features

This software has the following features:

- Support multiple channel monitoring and playback with a max of 16 windows.
- Support instant playback in preview window.
- Playback supports quick, slow and frame by frame modes.
- Support local snapshot and recording. Corresponding files are stored locally.
- Support PTZ control by slide on touch screen.
- Support memory of previous channel viewed.
- Support video window adjustment and bit stream adjustment.
- Support alarm push.
- Support alarm output control from smart phone for alarm push function.
- Support Smart Picture function which zooms in/out picture to view different parts of picture.
- Support E-Map function, to show cameras on an electronic map of household or area.
- Support channel resolution and frame configuration, and view of HDD info.
- Support VTO visual talk

9.3 Compatible Models

Android	Android 4.0 and higher Note: To use the push function, you need to create a Google account first.
iphone	IOS 6.0 and higher

Downloading and Installation

The product has Android and iOS versions.

Android: Open Google Play app in your smart phone. Search “My Secure Pro”, download it and install it.

iOS: Open App Store app in your smart phone. Search “My Secure Pro”, download it and install it.

10. App short description

All detailed functions of the app buttons are to find under “Help” main interface!



- 1 Snapshot the selected window
- 2 Start/Stop record of the selected window
- 3 Playback of the last 30 seconds
- 4 Start/Stop two way talk (not TX-65, 66, 67)
- 5 Video Door phone control (optional)

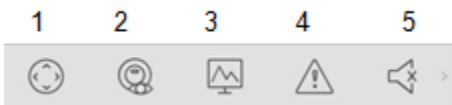

- 1 PTZ control
- 2 Fish-eye (optional)
- 3 Set resolutions
- 4 Alarm (optional)
- 5 Audio On/Mute



- 1 Set resolution
- 2 Alarm (optional)
- 3 Audio On/Off (optional)
- 4 Open/Close light control panel (optional)
- 5 Open/Close display parameter panel

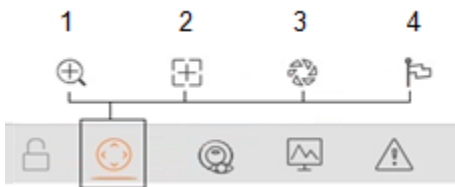

- 1 Zoom In/ out
- 2 Focus control
- 3 Iris control
- 4 Preset call (Only TX-67)

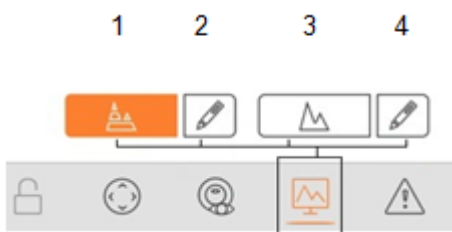

- 1 Sub Stream:
Lower resolution (lower Bit rate)/
faster data transmission
- 2 Set Sub Stream parameter.
- 3 Main Streams:
Higher resolution (higher Bite rate)/
slower data transmission
- 4 Set Main Stream parameter.

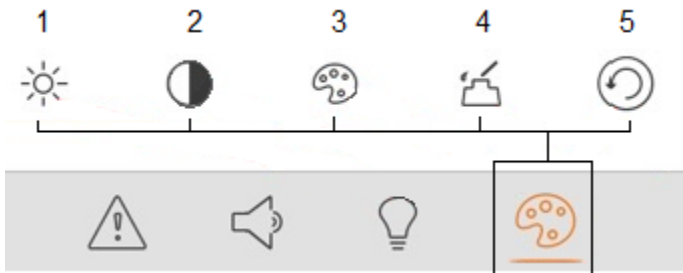

- 1 Set Brightness
- 2 Set Contrasts
- 3 Set Hue
- 4 Set Saturation
- 5 Reset

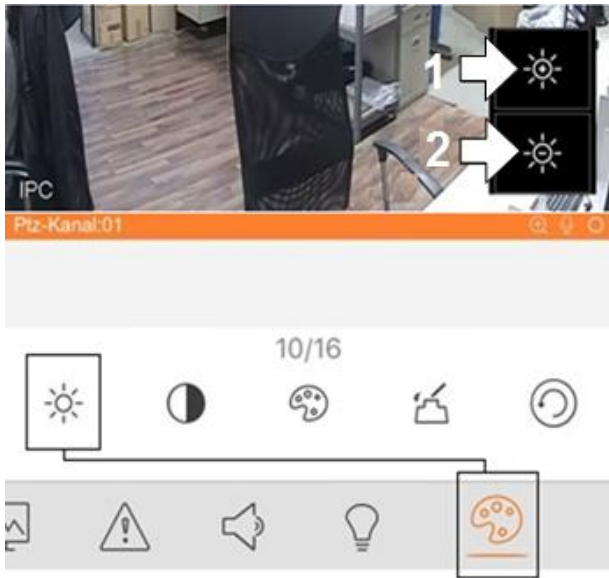

- 1 Add Brightness
- 2 Reduce Brightness

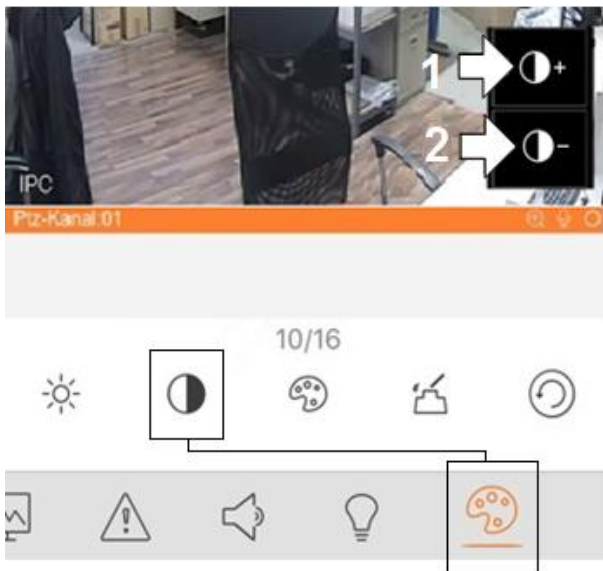

- 1 Add contrast
- 2 Reduce contrast



1 Add Hue
2 Reduce Hue

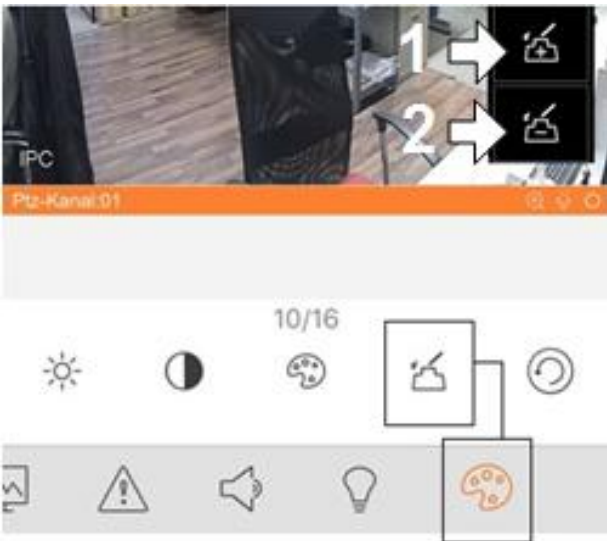

1 Add Saturation
2 Reduce Saturation

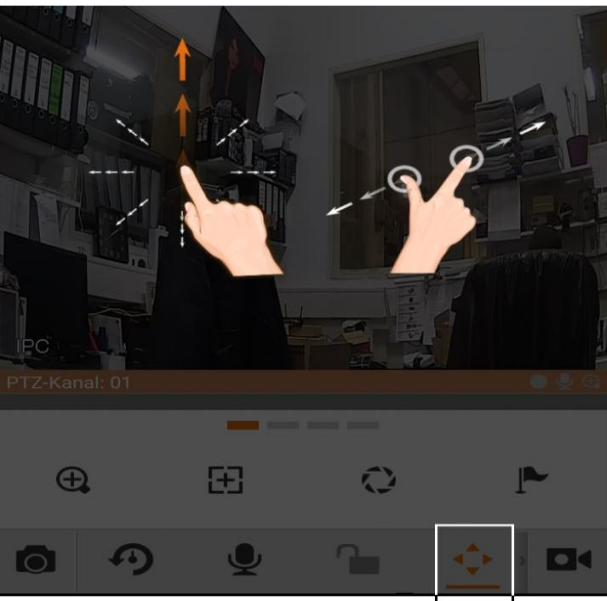

PTZ function

11. Operation

11.1 Remote Monitoring

As in Figure 11-1, select the first icon to enter App, select the second icon shows the startup page.



Figure 11-1

11.2 Main Menu

Enter camera, you will see Live Preview interface in Figure 11- 2 by default. For detailed information see chapter 11.5 Live Preview.

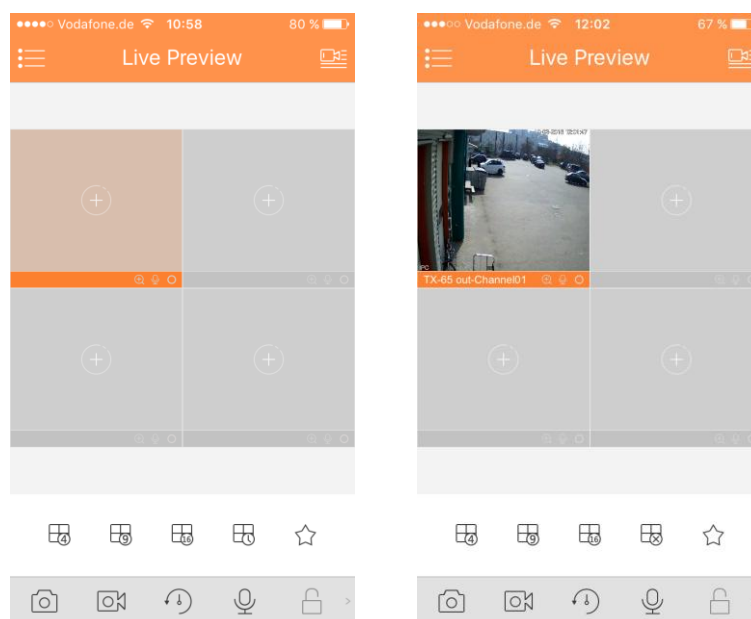



Figure 11- 2

Click on , system displays main menu interface in Figure 11- 3.

User can click on function in main menu to enter corresponding function interface. Main functions includes: Live Preview, Playback, Device Manager, Local File, E-Map, Favorites, Alarm and More.

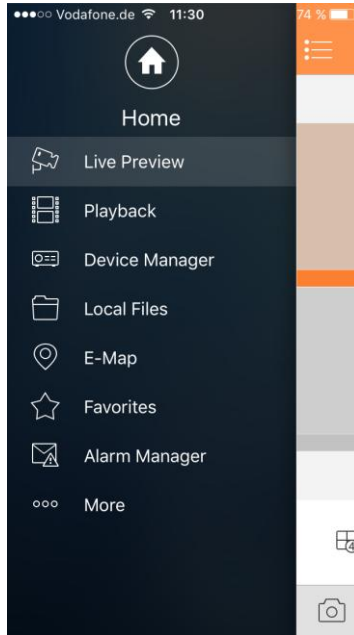



Figure 11- 3

11.3 Playback

Click on  button to view main menu. Click on playback on main menu to enter playback interface. The default is to play record, but you can switch it to picture by clicking on tab above.

System supports record playback  and picture playback .

Record playback is to play record saved on device; picture playback is to play picture saved on front-end device.

11.3.1 Watch Playback

To record:

- Step 1. Click on  in window to open device list.
- Step 2. Select playback period. (Set start and end date/time)
- Step 3. Select record channel to view. System can play video of selected channel in selected window

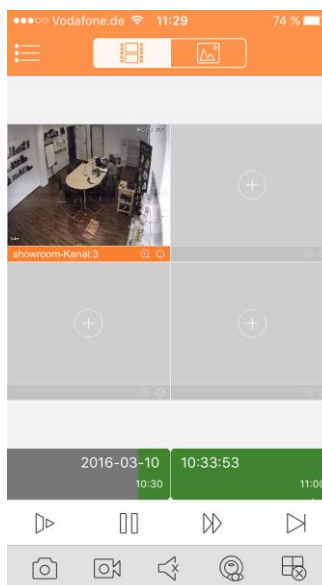













Figure 11- 4



Close playback:

- Close a single channel playback: long press video to close playback and drag it to the trashcan above.
- Close all channels' playback: click on  to close all playback.

Parameter	Note
	<p>Quick/Slow</p> <ul style="list-style-type: none"> ● Quick: quick play with 2x, 4x or 8x speed. Select playing video, click on  to 2x play; click on , to 4x play. During 4x play, click on  to 8x play. ● Slow: slow play with 1/2x, 1/4x and 1/8x speed. Select playing video, click on  to 1/2 play; click on  to 1/4 play. During 1/4 play, click on  to 1/8 play.
	Play/Pause
	Play by frame. Click on  to play next frame.

11.3.2 Picture Playback

To playback picture:

1. Click on  button to open device list.
 2. Select playback period.
 3. Select picture channel to view. System will play picture of selected channel in selected window.
- Click on  to close playback.
 - Smart mode: During picture playback, click on  to enter smart mode. Window becomes 4-split. Zoom in/out in window 2/3/4.

11.4 Device Manager

In Device Manager, add device, modify device info, remotely configure device, control alarm output, view HDD and delete. You also can import device list on cloud-end. Click on added device in the list, to see its functional buttons.

11.4.1 Add Device

To add device: In device manager interface, click on  to enter add device interface, see Figure 11- 5.

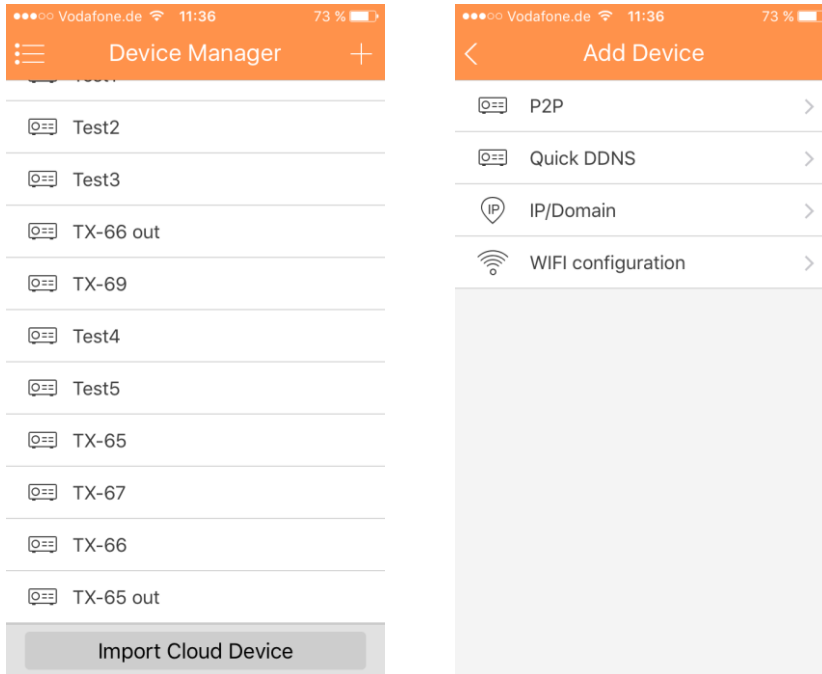



Figure 11- 5

Parameter	Note
Register Mode	<ul style="list-style-type: none"> • P2P: For network environment, add device by scanning two-dimension code, inputting SN. • Quick DDNS: For network environment, add device by inputting complete domain name address, and analysis is done by Quick DDNS. • IP/Domain name: For normal environment, add device by inputting its IP address or third-party domain name. • WIFI configuration: Under good WIFI network select this option
Name	<ul style="list-style-type: none"> • Device name: Choose for yourself
SN	<ul style="list-style-type: none"> • P2P type: Scanning two-dimension code, input SN. • Quick DDNS type: Input complete domain name. • IP/Domain name type: Input IP address or complete third party domain name. • WIFI configuration: Scanning two-dimension code, input SN
Username/Password	Device username and password are both admin. If changed, input new username and password.
Live Preview/Playback	Select main stream or extra stream for live preview and playback.

11.4.1.1 P2P configuration

Select the P2P connection from Add Device (Figure 11-5 above).

1. Press on the button  and scan the QR-Code of the device.
2. Name the device connection.
3. Username and Password are default (admin/admin).
4. Select in Live Preview between Main and Extra stream.

Default: Extra stream

Note: Under poor network environment we suggest to set to Extra stream.

5. Press to save: 

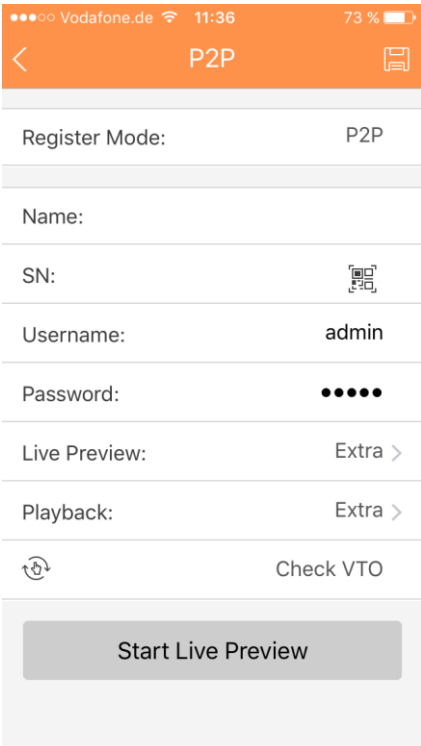

Vodafone.de 11:36 73 %

P2P

Register Mode: P2P

Name:

SN: 

Username: admin

Password: ●●●●

Live Preview: Extra >

Playback: Extra >

 Check VTO

Start Live Preview

11.4.1.2 Quick DDNS configuration

To configure the Quick DDNS take the domain name from web interface of the device under Setup-> Network-> DDNS/ Domain Name. Each device has a default domain name (Generated by MAC address). You can also use customized valid domain name (has not registered).

Before you use Quick DDNS, you need to enable the service.

After successful registration, you can use domain name to login installed of the device IP.

Note:

- User name is optional.
- System may take back the domain name that is idle for one year. You can get a notification email before the cancel operation if your email address setup is OK.

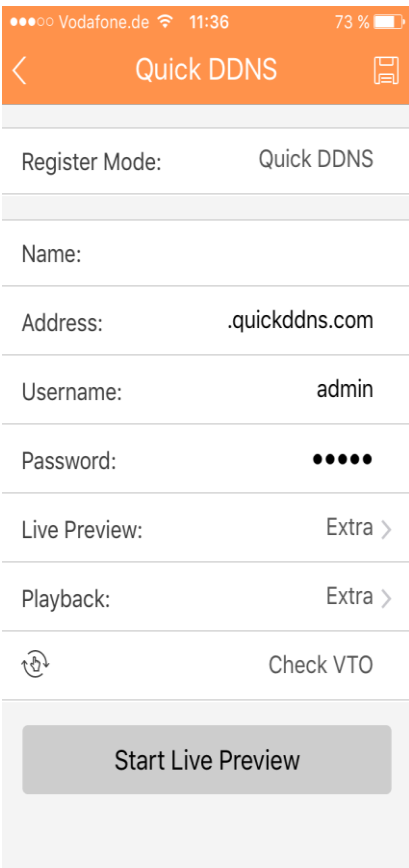

Vodafone.de 11:36 73 %

Quick DDNS

Register Mode: Quick DDNS

Name:

Address: .quickddns.com

Username: admin

Password: ●●●●

Live Preview: Extra >

Playback: Extra >

 Check VTO

Start Live Preview

11.4.1.3 IP/Domain configuration

To configure IP/Domain:

1. Set the Device Name under Name
 2. Set the IP Address of the device
(Use the Config Tool to find the IP-Address of your WIFI camera, see 5 Quick configuration tool).
 3. Save and press “Start Live Preview”
- Note:** The access to the WIFI camera will be available only under intra network.

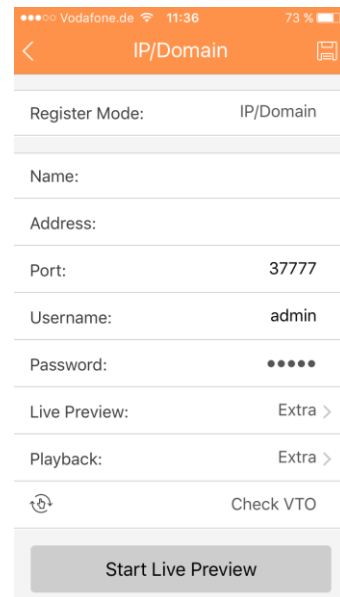

11.4.1.4 WIFI configuration

1. Interface display: name, SN (QR code), username, password, live preview, and playback. See Figure 11- .
2. Click , scan QR code and the picture will be similar to figure below.
3. Press “Next” button in figure 11-7.

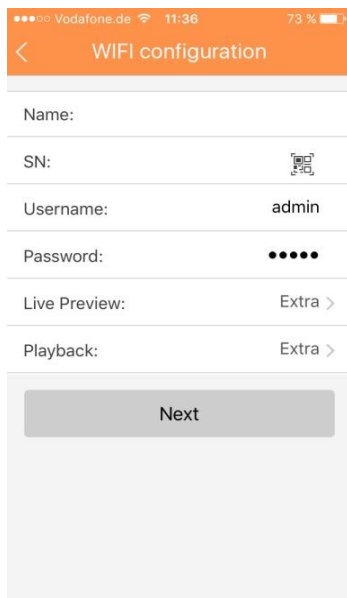

Figure 11- 6

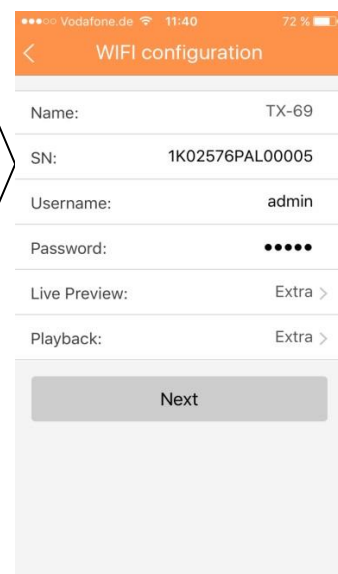

Figure 11- 7

4. Your Smartphone will use the WIFI connection you are currently connected to. Insert the password of your WIFI router like seen in figure 11-8.
5. Press “Next” button.
6. System auto configure (wait). Figure 11-9
7. If failed, then click try again or repeat the above steps.
8. All configurations are saved automatically, when correct. See figure 11-10.
9. Press “Start Live preview”. See figure 11-10.



Figure 11-8

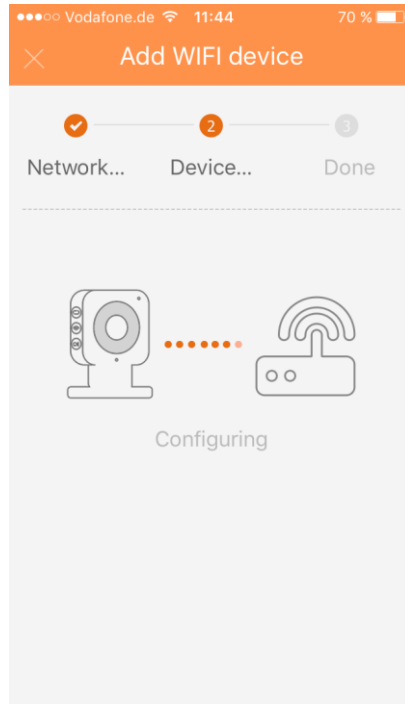

Figure 11-9

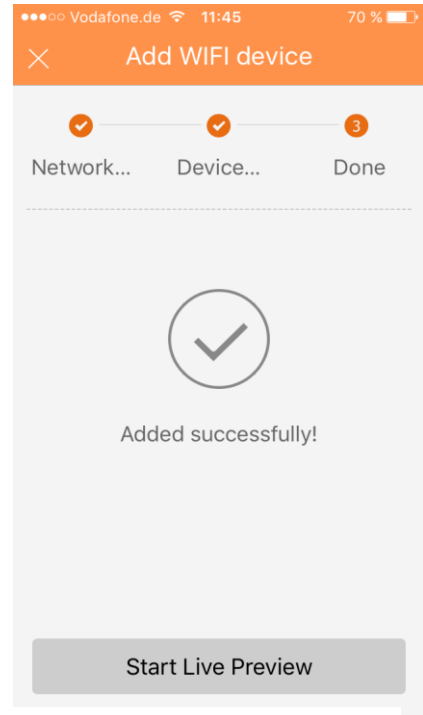



Figure 11- 10

11.4.2 Modify Device Info

To modify device information:
In device manager interface, click on device you want to modify. System shows dropdown menu in Figure 11- 11.

Click on  in dropdown menu.

Change device info, and click on  to save.

Tip:

- You can click on Start Live Preview to view all channels of the device. System will go to monitoring page and save device info.

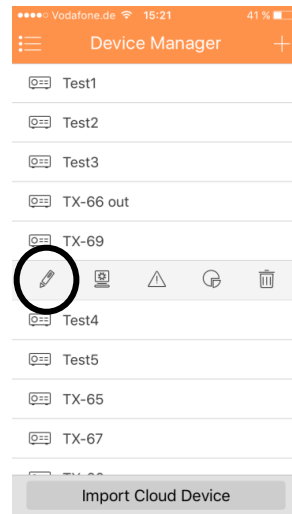



Figure 11- 11

11.4.3 Remote Configuration

Via remote configuration, you can perform function of motion detect, alarm setting, camera setting, storage manager and user manager.

To configure:
In device manager interface, click on device. System shows dropdown menu in Figure 11-12.

Click on  in dropdown list.

Select corresponding item to remotely configure. You will see Figure 11-13.

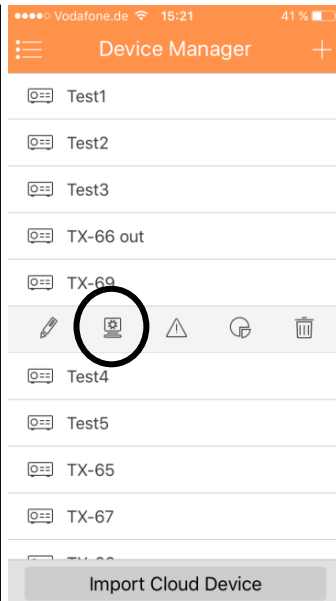

Figure 11- 12

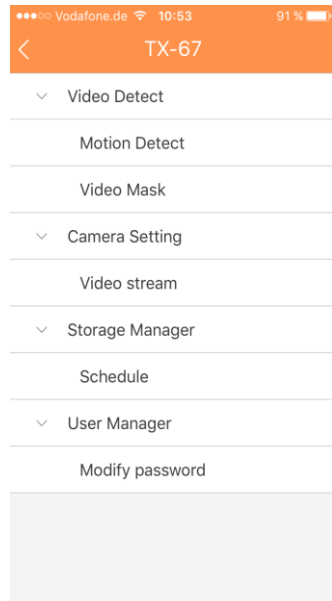

Figure 11-13

11.4.3.1 Video Detect

A: Motion Detect (Compare with chapter 6.6.3.1)

1. Enable Motion Detect. See Figure 11-14.
2. Enable Advanced config. See Figure 11-14.
3. Now you can set the following settings:
 - **Period:** Here you can set motion detect period. System only enables motion detect operation in the specified periods. Note: System only supports 6 periods in one day. Save the settings after changing.
 - **Anti-dither:** Here you can set anti-dither time. The value ranges from 0 to 100s. The anti-dither time refers to the alarm signal detected lastly. After 1s, if system detects another alarm signal, it can generate an alarm since the anti-dither time is out.
 - **Sensitivity:** Sensitivity can be set in the range from 0 to 100.
 - **Region Setting:** Here you can set motion detection region. Then click on the start point of the area you want to select and drag to select the area. Depending on your given environment this settings can be vary. In this case a subjective setting by the customer is requested!

After you completed the setup remember to click the save button to save current setup. See Figure 11-15.

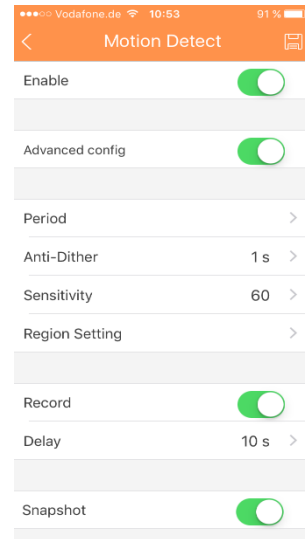

Figure 11-14



Figure 11-15

B: Video Mask

- Record: System auto activates motion detection channel to record once an alarm is detected.
- Delay: System can delay the record for specified time after alarm ended. The value ranges from 10s to 300s.
- Snapshot: You can enable this function to snapshot image when a motion detect alarm is detected.

11.4.3.2 Camera Setting

A: Video Stream

1. Click on the option Video Stream you see in Figure 11-16.
2. Then select the channel you like to configure.
3. You will see Figure 11-16, where you can set options for the Extra and the Main stream. Encode, Video, Audio (only TX-67), Resolution, Frame rate, Bit rate type and Bitrate.

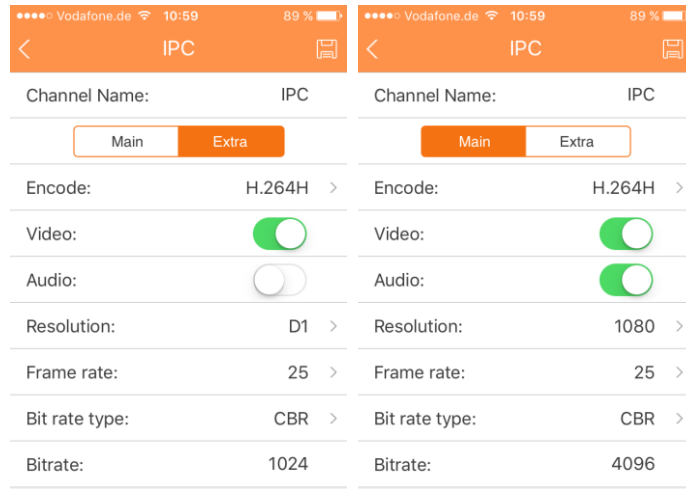

Figure 11-16

11.4.3.3 Storage Manager

A: Schedule

Under Schedule you can set the date & time and the recording type (Normal (green), Motion (orange) and Alarm (red)). See Figure 11-17

Select Date & Time and check the box to select corresponding record type. There are three types: Normal / Motion / Alarm.

Note: System only supports 6 periods in one day. Save the settings after changing.

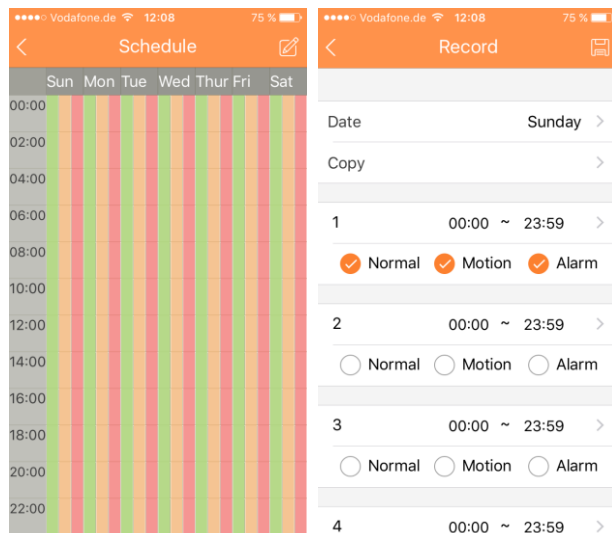

Figure 11-17

11.4.3.4 User Manager

A: Modify Password

Change the default password of the device.

11.4.4 Alarm Out Control (optional)

You can enable and disable alarm output of channel.

To enable or disable alarm output:
In device manager interface, click on device. System shows dropdown menu in Figure 11-18.

In dropdown menu, click on  .

Select alarm out channel, click on  to enable or disable alarm out.

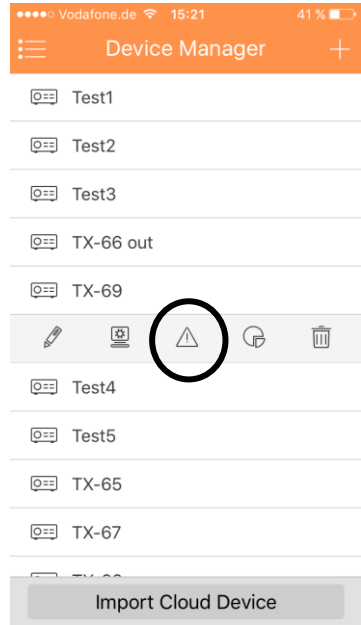



Figure 11- 18

11.4.5 View HDD Information

You can view HDD name, status, free capacity and total capacity.

In device manager interface, click on device. System shows dropdown menu in Figure 11- .

In dropdown menu, click on  to view HDD information.

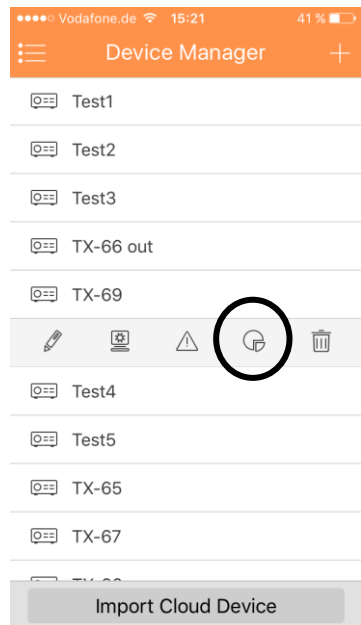



Figure 11- 19

11.4.6 Delete Device

To delete device:

In device manager interface, click on device. System shows dropdown menu in Figure 11-20.

Click on  in dropdown menu. System asks if to delete the device.

Click on OK.

Note: If it is not possible, to remove the camera, delete the push function for the camera!

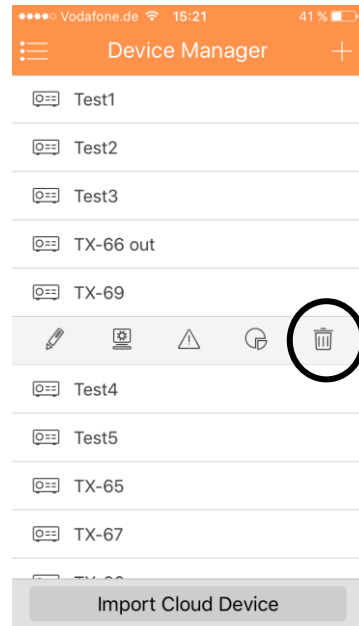

Figure 11- 20

11.4.7 Import Cloud Device

Press “Import Cloud Device” to import cloud device. See Figure 11-21.

For example, you have a cloud account (i.e. DDNS account), and the account is bound with device, then you can import corresponding devices on client without manually adding one by one.

To import cloud device:

1. In device manager interface, click on import cloud device button.
2. Select cloud account type, and input username and password.
 - QuickDDNS: use cloud account on Quick DDNS.
3. Click on Login to import device under the cloud account.

Note:

Device from DDNS account will have “?” mark. DDNS only memorizes IP the binding relationship between the device and domain name. The “?” means there is incomplete information of device user and password which shall be completed later.

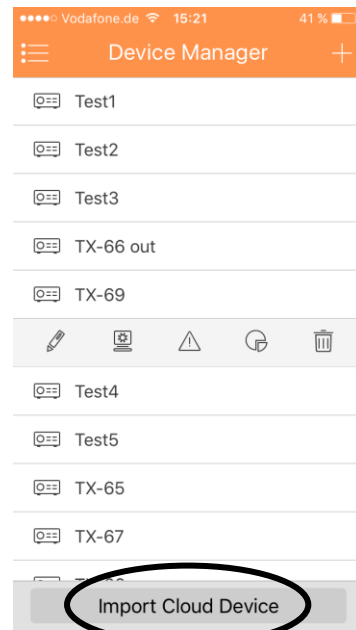



Figure 11- 21

11.5 Live Preview

Click on  and click on  Live Preview in main interface to enter live preview. See Figure 11-22. When you click camera, you will enter see live preview interface by default. Slide tool bar at the bottom to display more buttons.

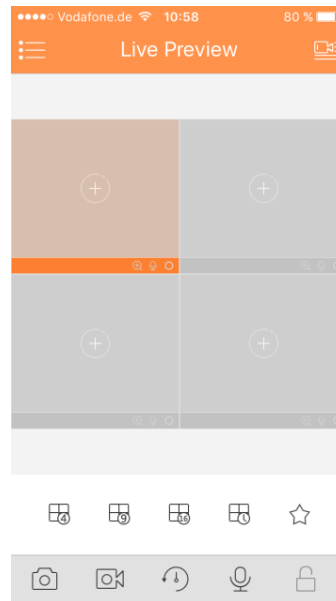



Figure 11- 22

11.5.1 Enable Monitoring

The app supports 4 methods to open monitoring.

1. In corresponding window open monitoring video of a certain window.

Click on  in window, select channel of displayed device to monitor the selected channel.

2. Open monitoring video of multiple windows.

Click on  at the upper-right corner, and select one or more channels in displayed device list. Click on Start Live Preview at the lower bottom. System will display monitoring video from first window in sequence as in Figure 11-23.

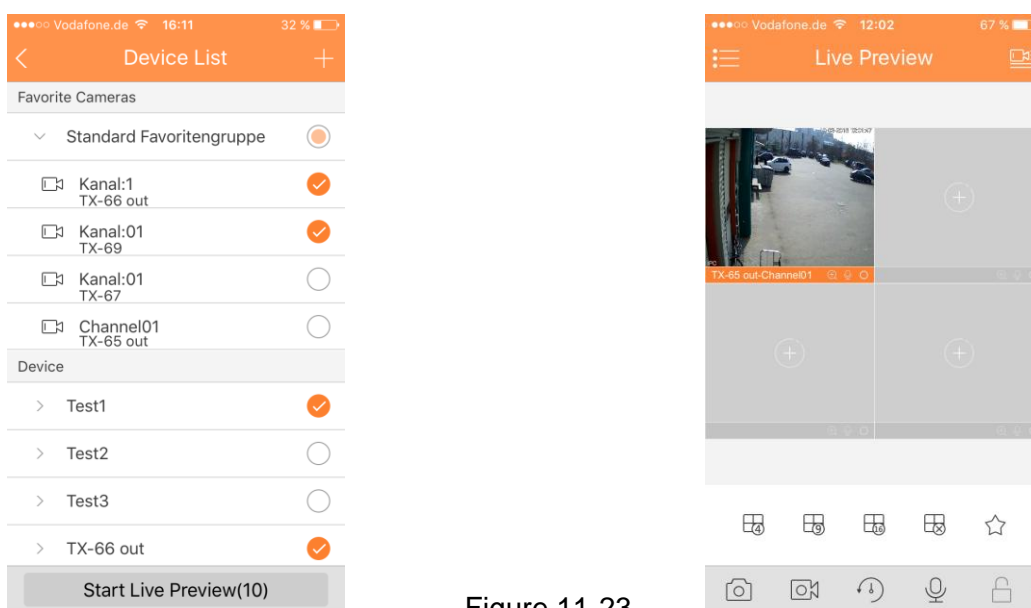





Figure 11-23

3. Open last channel

Click on  to open channel viewed last time

4. System supports favorites.

In  live preview interface, select a video window in preview, click on  to add it to favorites, see Figure 11-24. Select Favorites and the process is complete.

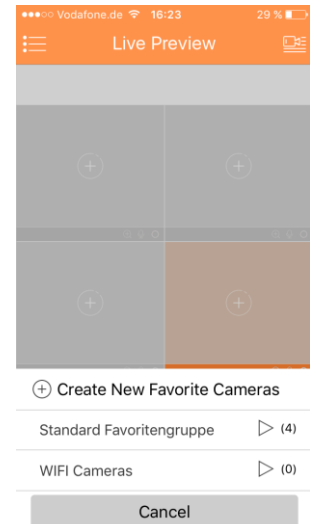

Figure 11-24

11.5.2 Close Monitoring

System supports two methods to close monitoring.

1. Close a single channel.

Long press monitoring window you want to close and drag it to the trashcan, it will be deleted. See Figure 11-25.

2. Close all monitoring channels.

Click on  to close all monitoring channels.

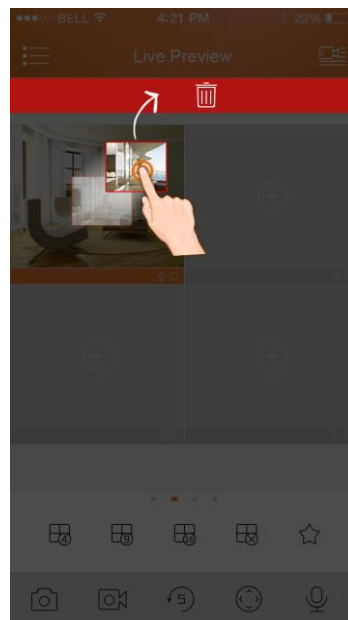



Figure 11- 25

11.5.3 Snapshot

Select channel to snapshot, click on  to snapshot current channel. View snapshots under local file path. **Note:** Android device can view snapshots directly under app installation path.

11.5.4 Record



Select designated record channel and click on  to start record. Record status on bar at the bottom will show a red dot. Click this button again to stop recording of the channel.

11.5.5 Playback

In live preview, click on , the selected channel will play video of the previous 30 seconds. Note: System default playback is 30 seconds.

Click on  to end playback and return to monitoring mode.

11.5.6 Bidirectional Talk (not for TX-65, 66, 67)

In live preview, click on , the symbol will change to  now you can talk and listen to the opponent on the other side of the selected channel. By pressing on the symbol again the bidirectional talk will be muted.

11.5.7 Unlock (optional)

Unlock function supports VTO.

Select channel connected to VTO to monitor, click  button, and corresponding VTO will unlock door.



11.7.8 PTZ Direction and Zooming (Only TX-67)

11.7.8.1 Direction and Zooming



Click on  to activate PTZ panel. The selected window will be maximized.

When PTZ control is activated, use hand to control PTZ direction by sliding touch screen:

- PTZ rotation: slide the touch screen toward designated direction to rotate PTZ (vertical, horizontal and diagonal).
- Focus control: Slide with two fingers to control focus.

Icon	Note
	Zoom control
	Focus control
	Iris control

11.7.8.2 Preset

On PTZ panel, click on  , select preset No., and click on  to adjust this preset point.



11.7.9 Fish-eye (optional)



Enter live preview interface, select one window, click fish-eye button  , and the interface shows fish-eye effect. In the fish-eye effect, you can slide to control the effect. Click fish-eye button again to exit. (Or double click to exit)

11.7.10 Bit Stream Switch

Choose between Main- and Extrastream.

- Under live preview, select a preview window, click on  . System displays bit stream switch panel as in Figure 11-26.

Icon	Note
	Fluent mode
	HD mode
	Custom mode

- Switch between main and extra stream.
 - Click on  , to switch to Fluent mode (extra stream).
 - Click on  , to switch to HD mode (main stream)
 - Click on  , may customize main/extra stream.

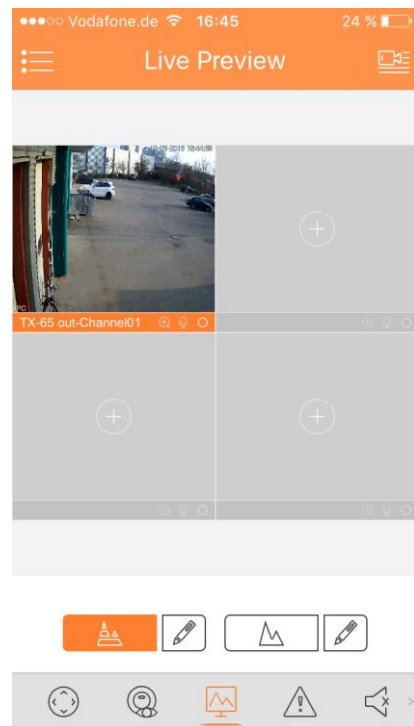



Figure 11-26

11.7.11 Alarm out Control (not TX-65, 66, 67)

System supports to enable or disable device alarm output.

1. Under live preview, select a monitoring channel, click on  button. Open corresponding alarm output of channel, see **Fehler! Verweisquelle konnte nicht gefunden werden**.figure 11-27.
2. Click on enable button to enable or disable a certain alarm output.

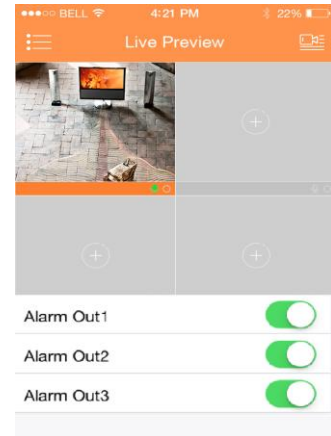







Figure 11-27

11.7.12 Audio (optional)

In live preview , click on  the symbol will change to  now you can listen to the oponent on the otherside of the selected channel. By pressing on the symbol again the channel will be muted.

11.7.12 Light Control (optional)





System supports to enable or disable device compensation light.

1. Under live preview, select a monitoring channel, click on  button, open corresponding light panel of the channel.
2. Click on on/off button to turn on/off compensation light.
3. Click on  or  to adjust light.

11.7.13 Image Adjustment

System supports image adjustment including brightness, contrast, saturation and etc.

1. In live preview, select a monitoring window, click on  button, open image adjustment control panel.

Icon	Note
	Adjust brightness
	Adjust contrast
	Adjust hue
	Adjust saturation
	Reset

2. Click on functional icon to adjust corresponding effect. increase/decrease parameter by clicking on +/- buttons in monitoring window.

11.7.14 Full Screen

In live preview, screen is rotated and enters full screen mode as in Figure 11-28.

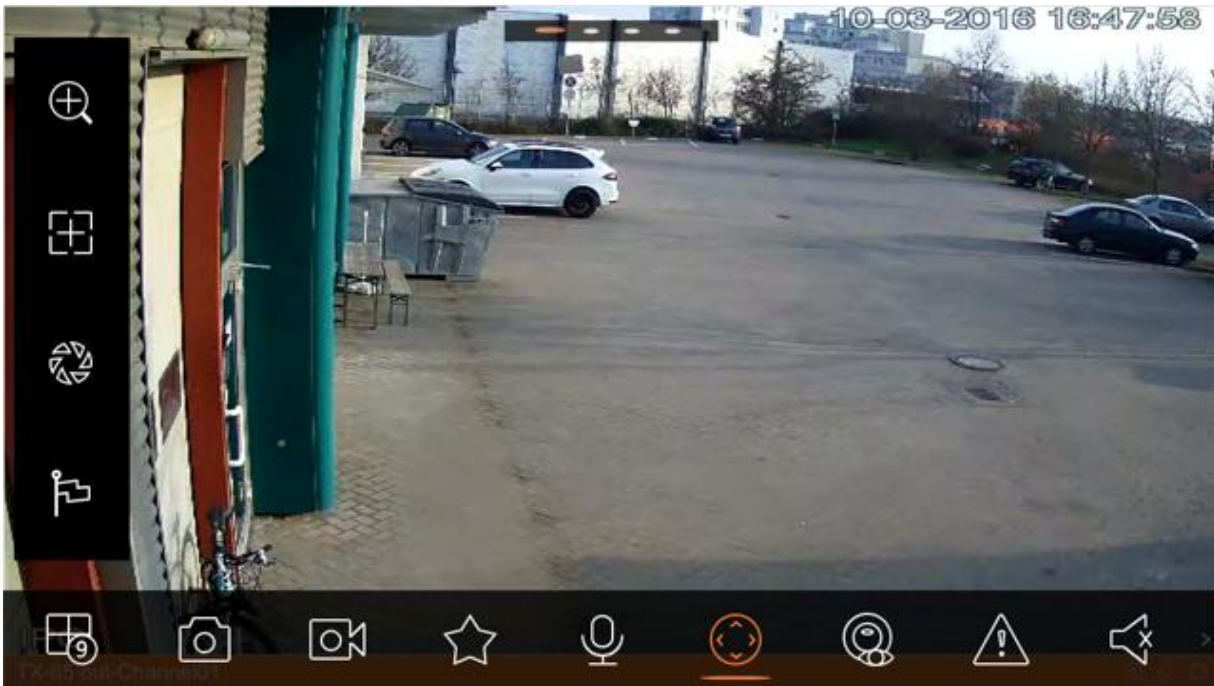

Figure 11- 28

Note: If you cannot enter full screen mode, check the settings of mobile phone.

11.7.14.1 Zoom In

Via touch signal to zoom in current video, and can drag zoomed video in order to view details in video.

11.7.14.2 Window Position Switch

Select a window, drag the window to the target window, and the two windows will switch position.



11.7.15 Local Files

System supports viewing and exporting of live preview and snapshot, record during playback.

11.7.15.1 View File



Click on recorded file to view. In the interface, you can play, pause, snapshot, play audio, quickly play, slowly play and etc.

11.7.15.2 Share File

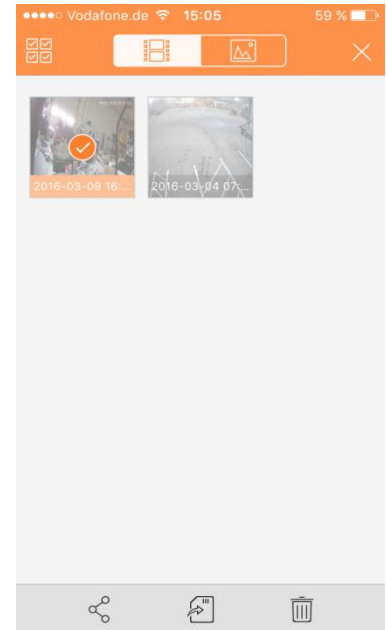

1. Click on  or long press file to enter file manager mode.
2. Select file to share.
3. Click on  to share file.



11.7.15.3 Export File



1. Click on  or long press local file to enter manager mode.
2. Select file to export.
3. Click on  to export video as in Figure 11-29

11.7.15.5 Delete File

1. Click on  or long press local file to enter manager mode.
2. Select file to delete.
3. Click on  to delete monitoring spot.

11.7.16 E-Map

11.7.16.1 Create E-Map

1. Click on  to add one picture as map.
2. Click on  to add monitoring spot on map. Go to device list interface and select channel.
3. Place added channel on appropriate location on map and click on  to save.

11.7.16.2 Edit E-Map

Select added e-map, click on  button to editing mode.

- Click on  to switch map.
- Click on  to add monitoring spot.
- Click on  to delete monitoring spot.
- Click on  to save.

11.7.17 Favorites

System supports to create new favorites, or add monitoring spot to existing favorites.

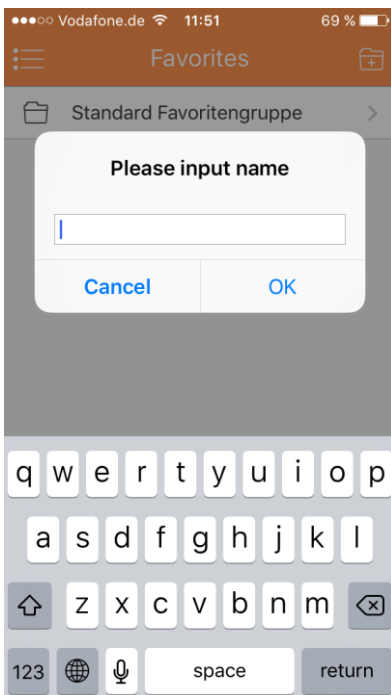





Figure 11- 30

1. Click on  and choose name to for the group. See Figure 11-30.
2. Click on the certain favorite group, to add devices. Click on  at upper-right corner to enter device list. Check designated channel and click on  to add it into favorites. See Figure 11-31.

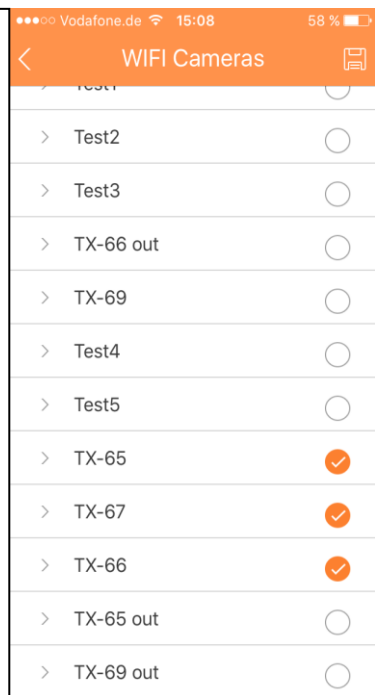

Figure 11- 31

Delete favorites:

- Delete favorite (Android): Long press favorite to delete and click on delete in pop-up box.
- Delete favorite (iOS): At row of favorite to delete, slide the delete button and click on delete button.

Remove monitoring spot in favorites:

- Delete video channel in favorites (Android): Enter favorites, long press channel to delete. Click on OK to delete it.
- Delete video channel in favorites (iOS): At row of channel to delete, slide the delete button and click on delete button.

11.7.18 Alarm Manager

Alarm push function is the function to push alarm info generated on device to mobile phone by integrating device alarm module. User can view Live Preview, Video and Image according to push info.

11.7.18.1 Push Configuration

1. Select device to receive push.
2. Enable the push function of the channel.
3. Select push type.

Parameter	Note
Push Type	In includes live, video and picture. If current device has record, and this push type is video, so when you receive push info, you can play the record. This is similar for the case of picture. If live preview is chosen you will see the live stream.

4. Select motion detection, cam masking or HDD Alarm and enable the channel.
5. Select alarm info, and select channel to push. Click on  to save.

11.7.18.2 Instant View of Alarm Push

After you have set push info, when front-end device generates alarm push, client-end will receive alarm info from the device. Click on info in notice bar to view detailed info. System will open record/picture according to the priority set by you. If there is no record or picture, system will go to live preview.

Note:

- Video and picture push requires storage medium on front-end device and you must set alarm record.
- System supports to store up to 50 historical records in event list.

11.7.18.3 Alarm Push Event List

Click on event list. You will see the history of the recorded events in event list. Click  dropdown button to enter event list interface. You will see the event (motion detection, cam masking and HDD alarm).

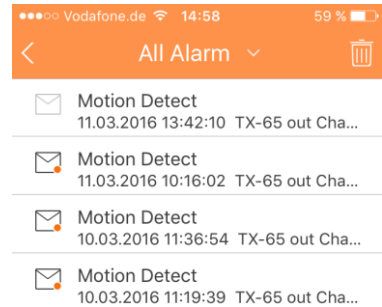

11.7.19 More/ Local Configuration/ Help

11.7.19.1 Local Configuration

System supports local configuration including PTZ step, capture mode, push duration, video mode and etc.

Parameter	Note
PTZ Step	Used to set PTZ step during live preview. The larger the step length, the higher the speed will be. Range: 1~8。
Snapshot	Configure continuous snapshot quantity in live preview interface and etc. There are three modes: 1x, 3x and 5x.
Push Duration	Set corresponding playback duration of push info, including: 15s, 30s, 1min, 2min, 5min.
Real-time Playback	Set playback period, as 5s~60s adjustable.
Protection	Set password protection of mobile monitoring app. After you have set password, every time you login, you must verify password for security purpose.

11.7.19.2 Help

Under Help you will find a manual for the most important points of the “My Secure App”. It is implemented in the App.

12. Technical Specifications

12.1 TX-65

Model	TX-65	
Image Sensor	1/3" 3Megapixel progressive scan CMOS	
Effective Pixels	2048(H) × 1536(V)	
Scanning System	Progressive	
Electronic Shutter Speed	Auto/Manual, 1s~1/100000s	
Min. Illumination	0. 1Lux/F2.0(Color), 0Lux/F2.0(IR on)	
S/N Ratio	More than 50dB	
Camera Features		
Max. IR LEDs Length	30m	
Day/Night	Auto(ICR)/Color/B/W	
Backlight Compensation	BLC / HLC / DWDR	
White Balance/Gain Control	Auto/Manual	
Noise Reduction	3D	
Privacy Masking	Up to 4 areas	
Lens		
Focal Length	3.6mm(2.8mm optional)	
Max Aperture	F2.0(F2.0)	
Focus Control	Manual	
Angle of View	H: 81°(92°)	
Lens Type	Fixed lens	
Mount Type	Board-in Type	
Video		
Compression	H.264/ H.264H/ H.264B/ MJPEG	
Resolution	3M(2048×1536)/1080P(1920×1080)/720P(1280×720)/ D1(704×576/704×480) /CIF(352×288/352×240)	
Frame Rate	Main Stream	3M(1 ~ 20fps)/1080P(1 ~ 25/30fps)
	Sub Stream	D1(1 ~ 25/30fps)
Bit Rate	H.264: 4kbps~8192kbps	
Corridor Mode	Support	
Network		
Ethernet	RJ-45 (10/100Base-T)	
Wi-Fi	WiFi(IEEE802.11b/g/n) 50m(open field)	
Protocol	IPv4/IPv6, HTTP, HTTPS, TCP/IP, UDP, UPnP, ICMP, IGMP, RTSP, RTP, SMTP, NTP, DHCP, DNS, PPPOE, DDNS, FTP, IP Filter, QoS	
Compatibility	ONVIF, CGI	
Max. User Access	20 users	
Smart Phone	iPhone, iPad, Android	
Auxiliary Interface		
Memory Slot	Micro SD card, up to 128GB	

General	
Power Supply	DC12V
Power Consumption	<4.5W(IR on)
Working Environment	-30°C~+60°C, Less than 95% RH
Ingress Protection	IP67
Weight / Dimensions	380g (with package 440g) / Φ 0.70 x 16.5 cm

12.2 TX-66

Model	TX-66	
Image Sensor	1/3" 3Megapixel progressive scan CMOS	
Effective Pixels	2048(H) x1536(V)	
Scanning System	Progressive	
Electronic Shutter Speed	Auto/Manual, 1s~1/100000s	
Min. Illumination	0.1Lux/F2.0(Color), 0Lux/F2.0(IR on)	
S/N Ratio	More than 50dB	
Video Output	N/A	
Camera Features		
Max. IR LEDs Length	30m	
Day/Night	Auto(ICR)/Color/B/W	
Backlight Compensation	BLC / HLC / DWDR	
White Balance	Auto/Manual	
Gain Control	Auto/Manual	
Noise Reduction	3D	
Privacy Masking	Up to 4 areas	
Lens		
Focal Length	3.6mm(2.8mm optional)	
Max Aperture	F2.0(F2.0)	
Focus Control	Manual	
Angle of View	H: 81°(92°)	
Lens Type	Fixed lens	
Mount Type	Board-in Type	
Video		
Compression	H.264/ H.264H/ H.264B/ MJPEG	
Resolution	3M(2048x1536)(2304x1296)/1080P(1920x1080)/ 720P(1280x720)/ D1(704x576/704x480)/ CIF(352x288/352x240)	
Frame Rate	Main Stream	3M(1 ~ 20fps)/1080P(1 ~ 25/30fps)
	Sub Stream	D1(1 ~ 25/30fps)
Bit Rate	H.264: 4kbps~8192kbps	
Corridor Mode	Support	
Audio		
Compression	N/A	
Interface	N/A	

Network	
Ethernet	RJ-45 (10/100Base-T)
Wi-Fi	Wi-Fi(IEEE802.11b/g/n) 50m(open field)
Protocol	IPv4/IPv6, HTTP, HTTPS, TCP/IP, UDP, UPnP, ICMP, IGMP, RTSP, RTP, SMTP, NTP, DHCP, DNS, PPPOE, DDNS, FTP, IP Filter, QoS
Compatibility	ONVIF, CGI
Max. User Access	20 users
Smart Phone	iPhone, iPad, Android
Auxiliary Interface	
Memory Slot	Micro SD card, up to 128GB
General	
Power Supply	DC12V
Power Consumption	<4.5W(IR on)
Working Environment	-30°C~+60°C, Less than 95% RH
Ingress Protection	IP67
Vandal Resistance	IK10
Weight / Dimensions	470g / Φ 11.0 x 0.81 cm

12.3 TX-67

Model	TX-67
Image Sensor	1/2.7" CMOS
Effective Pixels	1920(H) x 1080(V), 2Megapixels
Scanning System	Progressive
Electronic Shutter Speed	1/1 ~ 1/30,000s
Min. Illumination	Color: 0.05Lux@F1.6; B/W: 0.005Lux@F1.6
S/N Ratio	More than 55dB
Camera Features	
Day/Night	Auto(ICR) / Color / B/W
Backlight Compensation	BLC / HLC / WDR
White Balance	Auto, ATW, Indoor, Outdoor, Manual
Gain Control	Auto / Manual
Noise Reduction	Ultra DNR (2D/3D)
Privacy Masking	Up to 24 areas
Digital Zoom	16x
Lens	
Focal Length	2.7mm~11mm(4x Optical zoom)
Max Aperture	N/A
Focus Control	Auto / Manual
FOV-H	H: 112.5° ~ 30°
Close Focus Distance	100mm~ 1000mm

PTZ		
Pan/Tilt Range	Pan: 0° ~ 355°; Tilt: 0° ~ 90°, auto flip 180°	
Manual Control Speed	Pan: 0.1° ~100° /s; Tilt: 0.1° ~60° /s	
Preset Speed	Pan: 100° /s; Tilt: 60° /s	
Preset	300	
PTZ Mode	5 Pattern, 8 Tour, Auto Pan, Auto Scan	
Speed Setup	Human-oriented focal length/ speed adaptation	
Power up Action	Auto restore to previous PTZ and lens status after	
Idle Motion	Activate Preset/ Pan/ Scan/ Tour/ Pattern if there is no command in the specified period	
Video		
Compression	H.264 / MJPEG	
Resolution	1080P(1920×1080)/ 720P(1280×720)/ D1(704×576/704×480) / CIF(352×288/352×240)	
Frame Rate	Main Stream	1080P/ D1 (1 ~ 25/30fps), 720P(1~50/60fps)
	Sub Stream 1	D1/CIF(1 ~ 25/30fps)
	Sub Stream 2	720P/ D1/ CIF (1 ~ 25/30fps)
Bit Rate	H.264: 448K ~ 8192Kbps, MJPEG: 5120K ~ 10240Kbps	
Intelligent Function		
IVS (optional)	Tripwire, Intrusion, Abandoned Object Detection, Missing Object Objection,	
Face Detection	Support	
Network		
Ethernet	RJ-45 (10/100Base-T)	
WIFI	Support	
Protocol	IPv4/ IPv6, HTTP, HTTPS, SSL, TCP/IP, UDP, UPnP, ICMP, IGMP, SNMP, RTSP, RTP, SMTP, NTP, DHCP, DNS, PPPOE, DDNS, FTP, IP Filter, QoS, Bonjour,	
ONVIF	ONVIF Profile S	
Max. User Access	20 users	
Smart Phone	iPhone, iPad, Android	
Auxiliary Interface		
Memory Slot	Micro SD, Max 128GB	
General		
Power Supply	DC12V	
Power Consumption	10W	
Working Environment	-30°C ~ 60°C / Less than 90% RH	
Ingress Protection	IP66 & IK10	
Weight / Dimensions	600g / Φ 12.2 x 0.89 cm	

This product includes software developed by third parties, including software which is released under the GNU General Public License Version 2 (GPL v2). This program is free software; you can redistribute it and/or modify it under the terms of the GNU General Public License as published by the Free Software Foundation; either version 2 of the License, or (at your option) any later version. You may obtain a complete machine-readable copy of the source code for the above mentioned software under the terms of GPL v2 without charge except for the cost of media, shipping, and handling, upon written request to Technaxx GmbH & Co. KG, Kruppstraße 105, 60388 Frankfurt am Main, Germany.

This program is distributed in the hope that it will be useful, but WITHOUT ANY WARRANTY; without even the implied warranty of MERCHANTABILITY or FITNESS FOR A PARTICULAR PURPOSE. See the GNU General Public License for more details. You should have received a copy of the GNU General Public License along with this program; if not, write to the Free Software Foundation, Inc., 51 Franklin Street, Fifth Floor, Boston, MA 02110-1301, USA. (Notice from Technaxx: A copy of the GPL is included below).

GNU GENERAL PUBLIC LICENSE: Version 2, June 1991 / Copyright (C) 1989, 1991 Free Software Foundation, Inc. / 51 Franklin Street, Fifth Floor, Boston, MA 02110-1301, USA. Everyone is permitted to copy and distribute verbatim copies of this license document, but changing it is not allowed.

Preamble

The licenses for most software are designed to take away your freedom to share and change it. By contrast, the GNU General Public License is intended to guarantee your freedom to share and change free software--to make sure the software is free for all its users. This General Public License applies to most of the Free Software Foundation's software and to any other program whose authors commit to using it. (Some other Free Software Foundation software is covered by the GNU Lesser General Public License instead.) You can apply it to your programs, too.

When we speak of free software, we are referring to freedom, not price. Our General Public Licenses are designed to make sure that you have the freedom to distribute copies of free software (and charge for this service if you wish), that you receive source code or can get it if you want it, that you can change the software or use pieces of it in new free programs; and that you know you can do these things.

To protect your rights, we need to make restrictions that forbid anyone to deny you these rights or to ask you to surrender the rights. These restrictions translate to certain responsibilities for you if you distribute copies of the software, or if you modify it.

For example, if you distribute copies of such a program, whether gratis or for a fee, you must give the recipients all the rights that you have. You must make sure that they, too, receive or can get the source code. And you must show them these terms so they know their rights.

We protect your rights with two steps: (1) copyright the software, and (2) offer you this license which gives you legal permission to copy, distribute and/or modify the software.

Also, for each author's protection and ours, we want to make certain that everyone understands that there is no warranty for this free software. If the software is modified by someone else and passed on, we want its recipients to know that what they have is not the original, so that any problems introduced by others will not reflect on the original authors' reputations.

Any free program is threatened constantly by software patents. We wish to avoid the danger that redistributors of a free program will individually obtain patent licenses, in effect making the program proprietary. To prevent this, we have made it clear that any patent must be licensed for everyone's free use or not licensed at all.

The precise terms and conditions for copying, distribution and modification follow.

TERMS AND CONDITIONS FOR COPYING, DISTRIBUTION AND MODIFICATION

0. This License applies to any program or other work which contains a notice placed by the copyright holder saying it may be distributed under the terms of this General Public License. The "Program", below, refers to any such program or work, and a "work based on the Program" means either the Program or any derivative work under copyright law: that is to say, a work containing the Program or a portion of it, either verbatim or with modifications and/or translated into another language. (Hereinafter, translation is included without limitation in the term "modification".) Each licensee is addressed as "you".

Activities other than copying, distribution and modification are not covered by this License; they are outside its scope. The act of running the Program is not restricted, and the output from the Program is covered only if its contents constitute a work based on the Program (independent of having been made by running the Program). Whether that is true depends on what the Program does.

1. You may copy and distribute verbatim copies of the Program's source code as you receive it, in any medium, provided that you conspicuously and appropriately publish on each copy an appropriate copyright notice and disclaimer of warranty; keep intact all the notices that refer to this License and to the absence of any warranty; and give any other recipients of the Program a copy of this License along with the Program. You may charge a fee for the physical act of transferring a copy, and you may at your option offer warranty protection in exchange for a fee.

2. You may modify your copy or copies of the Program or any portion of it, thus forming a work based on the Program, and copy and distribute such modifications or work under the terms of Section 1 above, provided that you also meet all of these conditions:

a) You must cause the modified files to carry prominent notices stating that you changed the files and the date of any change.

b) You must cause any work that you distribute or publish, that in whole or in part contains or is derived from the Program or any part thereof, to be licensed as a whole at no charge to all third parties under the terms of this License.

c) If the modified program normally reads commands interactively when run, you must cause it, when started running for such interactive use in the most ordinary way, to print or display an announcement including an appropriate copyright notice and a notice that there is no warranty (or else, saying that you provide a warranty) and that users may redistribute the program under these conditions, and telling the user how to view a copy of this License. (Exception: if the Program itself is interactive but does not normally print such an announcement, your work based on the Program is not required to print an announcement.)

These requirements apply to the modified work as a whole. If identifiable sections of that work are not derived from the Program, and can be reasonably considered independent and separate works in themselves, then this License, and its terms, do not apply to those sections when you distribute them as separate works. But when you distribute the same sections as part of a whole which is a work based on the Program, the distribution of the whole must be on the terms of this License, whose permissions for other licensees extend to the entire whole, and thus to each and every part regardless of who wrote it.

Thus, it is not the intent of this section to claim rights or contest your rights to work written entirely by you; rather, the intent is to exercise the right to control the distribution of derivative or collective works based on the Program.

In addition, mere aggregation of another work not based on the Program with the Program (or with a work based on the Program) on a volume of a storage or distribution medium does not bring the other work under the scope of this License.

3. You may copy and distribute the Program (or a work based on it, under Section 2) in object code or executable form under the terms of Sections 1 and 2 above provided that you also do one of the following:

a) Accompany it with the complete corresponding machine-readable source code, which must be distributed under the terms of Sections 1 and 2 above on a medium customarily used for software interchange; or,

b) Accompany it with a written offer, valid for at least three years, to give any third party, for a charge no more than your cost of physically performing source distribution, a complete machine-readable copy of the corresponding source code, to be distributed under the terms of Sections 1 and 2 above on a medium customarily used for software interchange; or,

c) Accompany it with the information you received as to the offer to distribute corresponding source code. (This alternative is allowed only for noncommercial distribution and only if you received the program in object code or executable form with such an offer, in accord with Subsection b above.)

The source code for a work means the preferred form of the work for making modifications to it. For an executable work, complete source code means all the source code for all modules it contains, plus any associated interface definition files, plus the scripts used to control compilation and installation of the executable. However, as a special exception, the source code distributed need not include anything that is normally distributed (in either source or binary form) with the major components (compiler, kernel, and so on) of the operating system on which the executable runs, unless that component itself accompanies the executable.

If distribution of executable or object code is made by offering access to copy from a designated place, then offering equivalent access to copy the source code from the same place counts as distribution of the source code, even though third parties are not compelled to copy the source along with the object code.

4. You may not copy, modify, sublicense, or distribute the Program except as expressly provided under this License. Any attempt otherwise to copy, modify, sublicense or distribute the Program is void, and will automatically terminate your rights under this License. However, parties who have received copies, or rights, from you under this License will not have their licenses terminated so long as such parties remain in full compliance.

5. You are not required to accept this License, since you have not signed it. However, nothing else grants you permission to modify or distribute the Program or its derivative works. These actions are prohibited by law if you do not accept this License. Therefore, by modifying or distributing the Program (or any work based on the Program), you indicate your acceptance of this License to do so, and all its terms and conditions for copying, distributing or modifying the Program or works based on it.

6. Each time you redistribute the Program (or any work based on the Program), the recipient automatically receives a license from the original licensor to copy, distribute or modify the Program subject to these terms and conditions. You may not impose any further restrictions on the recipients' exercise of the rights granted herein. You are not responsible for enforcing compliance by third parties to this License.

7. If, as a consequence of a court judgment or allegation of patent infringement or for any other reason (not limited to patent issues), conditions are imposed on you (whether by court order, agreement or otherwise) that contradict the conditions of this License, they do not excuse you from the conditions of this License. If you cannot distribute so as to satisfy simultaneously your obligations under this License and any other pertinent obligations, then as a consequence you may not distribute the Program at all. For example, if a patent license would not permit royalty-free redistribution of the Program by all those who receive copies directly or indirectly through you, then the only way you could satisfy both it and this License would be to refrain entirely from distribution of the Program.

If any portion of this section is held invalid or unenforceable under any particular circumstance, the balance of the section is intended to apply and the section as a whole is intended to apply in other circumstances.

It is not the purpose of this section to induce you to infringe any patents or other property right claims or to contest validity of any such claims; this section has the sole purpose of protecting the integrity of the free software distribution system, which is implemented by public license practices. Many people have made generous contributions to the wide range of software distributed through that system in reliance on consistent application of that system; it is up to the author/donor to decide if he or she is willing to distribute software through any other system and a licensee cannot impose that choice.

This section is intended to make thoroughly clear what is believed to be a consequence of the rest of this License.

8. If the distribution and/or use of the Program is restricted in certain countries either by patents or by copyrighted interfaces, the original copyright holder who places the Program under this License may add an explicit geographical distribution limitation excluding those countries, so that distribution is permitted only in or among countries not thus excluded. In such case, this License incorporates the limitation as if written in the body of this License.

9. The Free Software Foundation may publish revised and/or new versions of the General Public License from time to time. Such new versions will be similar in spirit to the present version, but may differ in detail to address new problems or concerns.

Each version is given a distinguishing version number. If the Program specifies a version number of this License which applies to it and "any later version", you have the option of following the terms and conditions either of that version or of any later version published by the Free Software Foundation. If the Program does not specify a version number of this License, you may choose any version ever published by the Free Software Foundation.

10. If you wish to incorporate parts of the Program into other free programs whose distribution conditions are different, write to the author to ask for permission. For software which is copyrighted by the Free Software Foundation, write to the Free Software Foundation; we sometimes make exceptions for this. Our decision will be guided by the two goals of preserving the free status of all derivatives of our free software and of promoting the sharing and reuse of software generally.

NO WARRANTY

11. BECAUSE THE PROGRAM IS LICENSED FREE OF CHARGE, THERE IS NO WARRANTY FOR THE PROGRAM, TO THE EXTENT PERMITTED BY APPLICABLE LAW. EXCEPT WHEN OTHERWISE STATED IN WRITING THE COPYRIGHT HOLDERS AND/OR OTHER PARTIES PROVIDE THE PROGRAM "AS IS" WITHOUT WARRANTY OF ANY KIND, EITHER EXPRESSED OR IMPLIED, INCLUDING, BUT NOT LIMITED TO, THE IMPLIED WARRANTIES OF MERCHANTABILITY AND FITNESS FOR A PARTICULAR PURPOSE. THE ENTIRE RISK AS TO THE QUALITY AND PERFORMANCE OF THE PROGRAM IS WITH YOU. SHOULD THE PROGRAM PROVE DEFECTIVE, YOU ASSUME THE COST OF ALL NECESSARY SERVICING, REPAIR OR CORRECTION.

12. IN NO EVENT UNLESS REQUIRED BY APPLICABLE LAW OR AGREED TO IN WRITING WILL ANY COPYRIGHT HOLDER, OR ANY OTHER PARTY WHO MAY MODIFY AND/OR REDISTRIBUTE THE PROGRAM AS PERMITTED ABOVE, BE LIABLE TO YOU FOR DAMAGES, INCLUDING ANY GENERAL, SPECIAL, INCIDENTAL OR CONSEQUENTIAL DAMAGES ARISING OUT OF THE USE OR INABILITY TO USE THE PROGRAM (INCLUDING BUT NOT LIMITED TO LOSS OF DATA OR DATA BEING RENDERED INACCURATE OR LOSSES SUSTAINED BY YOU OR THIRD PARTIES OR A FAILURE OF THE PROGRAM TO OPERATE WITH ANY OTHER PROGRAMS), EVEN IF SUCH HOLDER OR OTHER PARTY HAS BEEN ADVISED OF THE POSSIBILITY OF SUCH DAMAGES.

END OF TERMS AND CONDITIONS

HOW TO APPLY THESE TERMS TO YOUR NEW PROGRAMS

(1) If you develop a new program, and you want it to be of the greatest possible use to the public, the best way to achieve this is to make it free software which everyone can redistribute and change under these terms.

(2) To do so, attach the following notices to the program. It is safest to attach them to the start of each source file to most effectively convey the exclusion of warranty; and each file should have at least the "copyright" line and a pointer to where the full notice is found.

<one line to give the program's name and an idea of what it does.>

Copyright (C) <yyyy> <name of author>

(3) This program is free software; you can redistribute it and/or modify it under the terms of the GNU General Public License as published by the Free Software Foundation; either version 2 of the License, or (at your option) any later version.

(4) This program is distributed in the hope that it will be useful, but WITHOUT ANY WARRANTY; without even the implied warranty of MERCHANTABILITY or FITNESS FOR A PARTICULAR PURPOSE. See the GNU General Public License for more details.

(5) You should have received a copy of the GNU General Public License along with this program; if not, write to the Free Software Foundation Inc; 51 Franklin Street, Fifth Floor, Boston, MA 02110-1301, USA.

(6) Also add information on how to contact you by electronic and paper mail.

(7) If the program is interactive, make it output a short notice like this when it starts in an interactive mode: Gnomovision version 69, Copyright (C) year name of author
Gnomovision comes with ABSOLUTELY NO WARRANTY; for details type `show w'.

(8) This is free software, and you are welcome to redistribute it under certain conditions; type `show c' for details.

(9) The hypothetical commands `show w' and `show c' should show the appropriate parts of the General Public License. Of course, the commands you use may be called something other than `show w' and `show c'; they could even be mouse-clicks or menu items--whatever suits your program.

(10) You should also get your employer (if you work as a programmer) or your school, if any, to sign a "copyright disclaimer" for the program, if necessary. Here is a sample; alter the names: **(11)** Yoyodyne, Inc., hereby disclaims all copyright interest in the program `Gnomovision' (which makes passes at compilers) written by James Hacker.

<signature of Ty Coon>, 1 April 1989 [Ty Coon, President of Vice]

(12) This General Public License does not permit incorporating your program into proprietary programs. If your program is a subroutine library, you may consider it more useful to permit linking proprietary applications with the library. If this is what you want to do, use the GNU Lesser General Public License instead of this License.