



Auranet

EAP110-Outdoor

Installation Guide

300Mbps Wireless N Outdoor Access Point

Contents

Overview	1
Typical Network Topology	4
Lightning and ESD Protection	5
Hardware Installation	6
Mount EAP	7
Connect Cables	9
Power On	10
Software Configuration	11

Overview

Package Contents

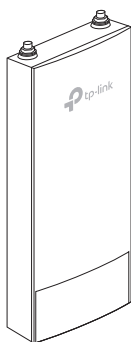

EAP

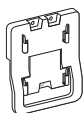

Mounting Bracket



M3×28 Plastic Wall Anchors(Qty.3)



Antennas (Qty.2)



M3×20 Self-tapping Screws (Qty.3)

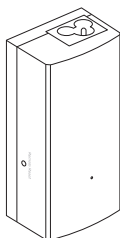

Passive PoE Adapter



Installation Guide



Metal Strap



Power Cord



Waterproof Rubber Insert

Panel Layout

The Panel of EAP

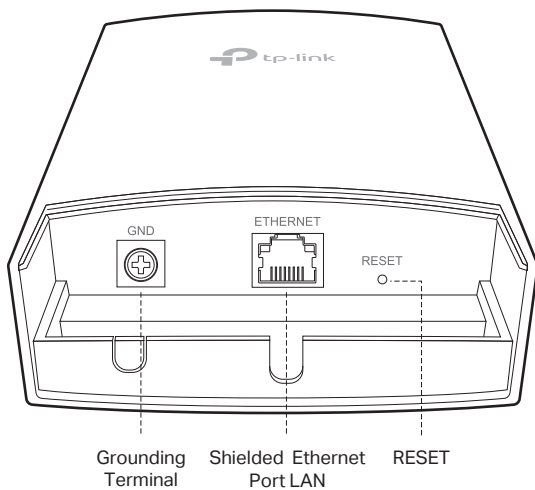

SYS LED Explanation

LED Status	Indication
Flashes green, red and yellow before remaining green	The device is initializing.
Flashes green twice	Initialization is completed.
Solid green	The device is working properly .
Flashes red	System errors. RAM, Flash, Ethernet, WLAN or firmware may be malfunctioning.
Flashes yellow	Firmware update is in progress. Do not disconnect or power off the device.
Double flashes red, green, yellow	The device is being reset to its factory default settings.

Passive PoE Adapter

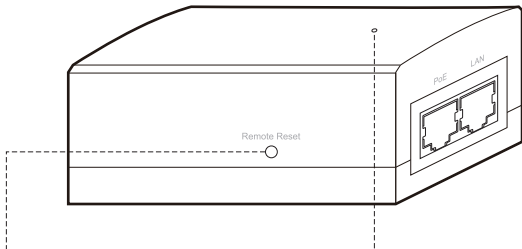

Remote Reset:
Press and hold for 8 seconds to reset the EAP to its factory default settings.

Power LED:
The Power LED indicates the status of the electric current:
On: Supplying power.
Off: Not supplying power.

Typical Network Topology

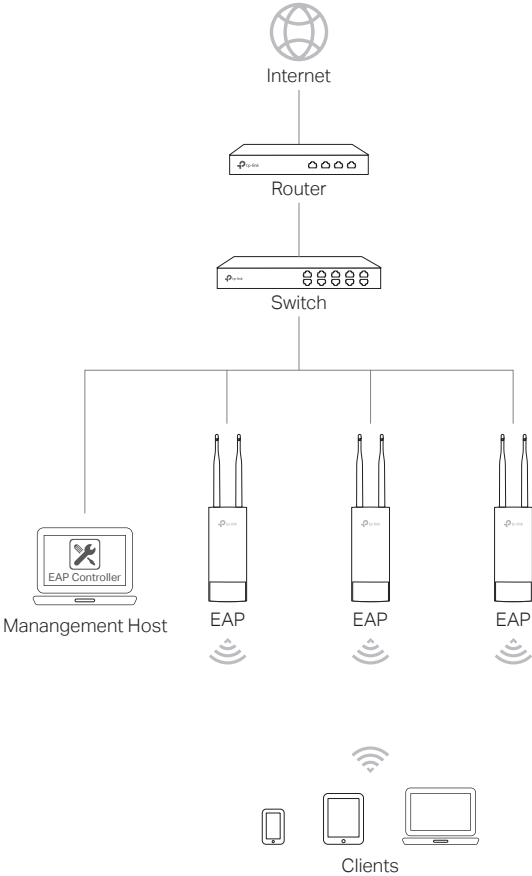

- A DHCP server (typically a router) is required to assign IP addresses to the EAPs and clients in your local network.
- The management host can be in the same or different network segment with the EAPs.

Lightning and ESD Protection

Before mounting EAP, you should consider Lightning and ESD Protection to ensure safety.

Proper grounding is extremely important for outdoor devices. There are two effective techniques for grounding the outdoor EAP:

Option A

Use a shielded CAT5e (or above) cable with an integrated grounding wire for connection.

Option B

If you have the standard CAT5e cable for the connection, use a separate grounding cable to connect the grounding Terminal (GND) to earth ground.

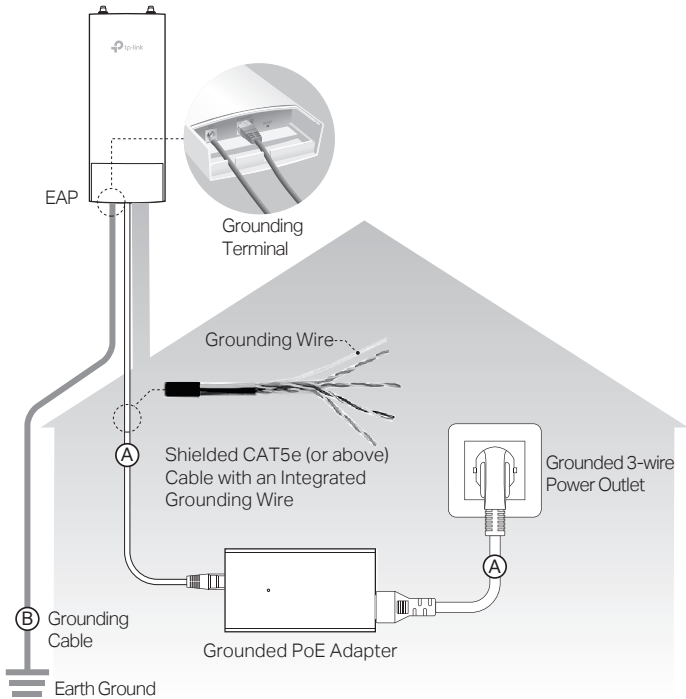

Hardware Installation

Mount EAP

The EAP can be pole-mounted or wall-mounted.

Option 1: Pole Mounting

Step 1:

Loosen and completely remove the end of the metal strap by turning the captive screw counterclockwise with a flathead screwdriver.

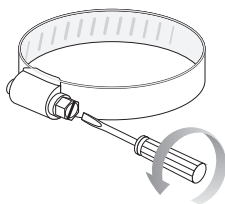

Step 2:

Lead the end of the metal strap through the back of the EAP.

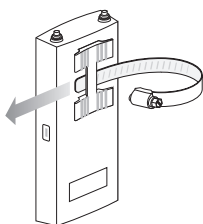

Step 3:

Position the EAP and wrap the metal strap around the pole. Feed the end back through the screw-block and turn the screw clockwise to tighten the metal strap using a flathead screwdriver until the EAP is secure.

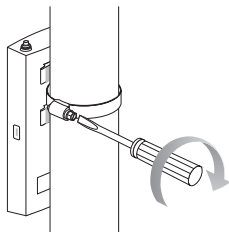

Step 4:

Connect the antennas to the EAP.

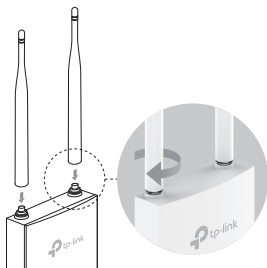

Option 2: Wall Mounting

Step 1:

Place the mounting bracket in the right position. Mark three positions for the screw holes.

Drill three 3.5mm holes for the screws at the marked positions.

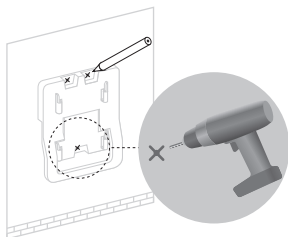

Step 2:

Insert the plastic wall anchors into the 3.5mm holes. Align the bracket to the plastic wall anchors and drive the self-tapping screws into the anchors through the bracket.

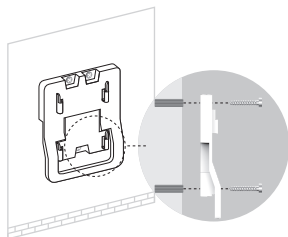

Step 3:

Align the mounting tabs on the back of the EAP with the four slots of the mounting bracket. Push and slide the EAP downward until it locks into place.

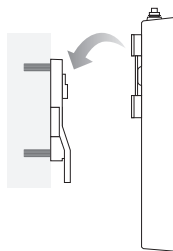

Step 4:

Connect the antennas to the EAP.

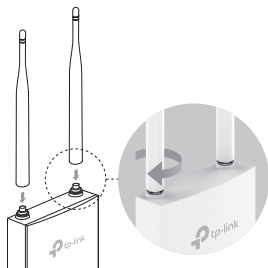

Connect Cables

Step 1:

Firmly grasp the rear of the interface cover and pull it downward.



Step 2:

Use an adequate Ethernet cable to connect the LAN port. The length of cable is up to 60m for steady power supply. Shielded CAT5e (or above) cable with an integrated ground wire is recommended.



Step 3:

Affix the waterproof rubber insert to the underside of the device for waterproofing and replace the cover until it firmly locks into place.

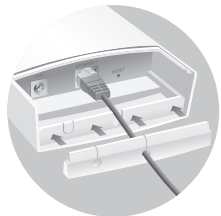

Power On

Connect the EAP to a Power over Ethernet (PoE) adapter as follows:

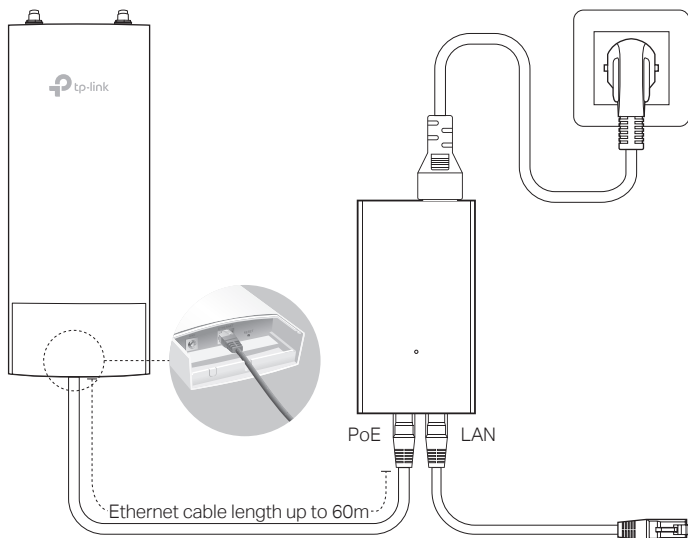

Step 1:

Connect the Ethernet cable from the EAP to the POE port of the PoE adapter.

Step 2:

Connect the power cord to the power port on the PoE adapter and plug it into an electrical outlet.

Step 3:

Connect an Ethernet cable from your LAN device (a computer, router or switch) to the LAN port on the PoE adapter.

Software Configuration

To quickly set up a wireless network connection with mass EAPs, please follow the steps below.

Note:

The IP address of the management host must be reachable for the EAPs in the network. In this example, the management host is in the same LAN with the EAPs.

Step 1: Installing the EAP Controller

On the management host, download the EAP Controller installation file from the product support page at www.tp-link.com. Run the file and follow the wizard to install the EAP Controller.

Step 2: Configuring the EAP Controller

Launch the EAP Controller and follow the configuration wizard to create a primary wireless network. After the wizard is finished, a login screen will appear. Enter the Admin name and password you created and click **Sign In**.

Step 3: Adopting the EAP devices

Adopt the EAP devices in the Controller management interface to change their status from **Pending** to **Connected**.

For More Configurations

Now you can manage your wireless network and view network statistics using the EAP Controller. Please refer to the EAP Controller User Guide to learn more information about configuring and using the Controller software.

