

Panasonic®

Operating Instructions Blu-ray Disc™ Recorder

Model No. **DMR-UBC90 DMR-UBS90**

ULTRAHD™
Blu-ray



Thank you for purchasing this product.
Please read these instructions carefully before using this product, and save this manual for future use.

Software (Firmware) Update



To support the latest features, it's very important you install the latest updates to maintain proper operation of your unit.
For details, refer to "Software (Firmware) Update" (⇒ 84) or <http://panasonic.jp/support/global/cs/>
(This site is in English only.)

Getting started

Watching broadcasts

Recording

Playing back video

Editing video

Copying video

Photo and Music

Network

With Other Equipment

Other functions

Setup

Reference

Features

Watch UHD/HDR broadcasts

You can watch UHD/HDR broadcasts. This unit supports HLG, which is one of HDR formats.

Refer to “Watching broadcasts”. (⇒ 30)

Record/store UHD/HDR programmes

This unit can simultaneously record three UHD/HDR broadcasts. Thanks to its 2 TB HDD, the unit offers ample space for storing UHD (4K) programmes. You can also copy recorded programmes to a USB HDD while maintaining the superb picture quality of UHD (4K).

Refer to “Recording TV programmes”. (⇒ 35)

Refer to “Copying programmes”. (⇒ 64)

Play UHD/HDR programmes and 4K content

This unit can play back recorded UHD (4K) programmes and 4K content stored on external media, such as USB devices.

Refer to “Playing programmes on the HDD”. (⇒ 47)

Refer to “Operation during play”. (⇒ 53)

Refer to “4K Networking”. (⇒ 57)

Play Ultra HD Blu-ray Discs

This unit can play back Ultra HD Blu-ray discs.

Refer to “Enjoying Ultra HD Blu-ray”. (⇒ 55)

Safety precautions

WARNING

Unit

- To reduce the risk of fire, electric shock or product damage,
 - Do not expose this unit to rain, moisture, dripping or splashing.
 - Do not place objects filled with liquids, such as vases, on this unit.
 - Use only the recommended accessories.
 - Do not remove covers.
 - Do not repair this unit by yourself. Refer servicing to qualified service personnel.
 - Do not let metal objects fall inside this unit.
 - Do not place heavy items on this unit.

AC mains lead

- To reduce the risk of fire, electric shock or product damage,
 - Ensure that the power supply voltage corresponds to the voltage printed on this unit.
 - Insert the mains plug fully into the socket outlet.
 - Do not pull, bend, or place heavy items on the lead.
 - Do not handle the plug with wet hands.
 - Hold onto the mains plug body when disconnecting the plug.
 - Do not use a damaged mains plug or socket outlet.
- The mains plug is the disconnecting device. Install this unit so that the mains plug can be unplugged from the socket outlet immediately.

Small object

- Keep the Memory Card out of reach of children to prevent swallowing.

CAUTION

Unit

- This unit utilizes a laser. Use of controls or adjustments or performance of procedures other than those specified herein may result in hazardous radiation exposure.
- Do not place sources of naked flames, such as lighted candles, on this unit.
- This unit may receive radio interference caused by mobile telephones during use. If such interference occurs, please increase separation between this unit and the mobile telephone.
- This unit is intended for use in moderate climates.

Placement

- Place this unit on an even surface.
- To reduce the risk of fire, electric shock or product damage,
 - Do not install or place this unit in a bookcase, built-in cabinet or in another confined space. Ensure this unit is well ventilated.
 - Do not obstruct this unit's ventilation openings with newspapers, tablecloths, curtains, and similar items.
 - Do not expose this unit to direct sunlight, high temperatures, high humidity, and excessive vibration.

Batteries

- Danger of explosion if battery is incorrectly replaced. Replace only with the type recommended by the manufacturer.
- Mishandling of batteries can cause electrolyte leakage and may cause a fire.
 - Do not mix old and new batteries or different types at the same time.
 - Do not heat or expose to flame.
 - Do not leave the battery(ies) in a car exposed to direct sunlight for a long period of time with doors and windows closed.
 - Do not take apart or short circuit.
 - Do not recharge alkaline or manganese batteries.
 - Do not use batteries if the covering has been peeled off.
 - Remove batteries if you do not intend to use the remote control for a long period of time. Store in a cool, dark place.
- When disposing of the batteries, please contact your local authorities or dealer and ask for the correct method of disposal.

Supplied accessories

Please check and identify the supplied accessories.

(Product numbers are correct as of March 2017. These may be subject to change.)

- Remote control (N2QAYB001114):** 1 pc.
- Batteries for remote control:** 2 pcs.
- AC mains lead:** 1 pc.
- UBC90**
- RF coaxial cable:** 1 pc.
- UBS90**
- Splitter:** 1 pc.
- Do not use AC mains lead with other equipment.

Insert batteries

Insert so the poles (+ and -) match those in the remote control.

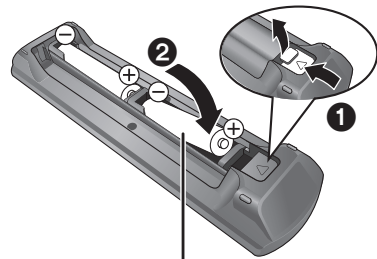

R6/LR6, AA
(Alkaline or manganese batteries)

About descriptions in these operating instructions

- These operating instructions are applicable to models DMR-UBC90 and DMR-UBS90. The illustrations in these Operating Instructions show images of DMR-UBC90 unless otherwise indicated.
 - **UBC90** : indicates features applicable to DMR-UBC90 only.
 - **UBS90** : indicates features applicable to DMR-UBS90 only.
- Pages to be referred to are indicated as "⇒ ○○".
- Images are for illustration purpose, contents may change without notice.

Table of contents

| | |
|----------------------|---|
| Features | 2 |
| Safety precautions | 2 |
| Supplied accessories | 3 |

Getting started

| | |
|------------------------------|----|
| Unit care | 5 |
| Main unit | 6 |
| Remote Control | 8 |
| CI (Common Interface) module | 9 |
| Connection | 11 |
| Settings | 19 |
| HDD and media information | 24 |
| FUNCTION MENU screen | 29 |

Watching broadcasts

| | |
|---------------------|----|
| Watching broadcasts | 30 |
|---------------------|----|

Recording

| | |
|----------------------------------|----|
| Recording TV programmes | 35 |
| Timer recording | 39 |
| Keyword Recording | 43 |
| Using the external HDD (USB HDD) | 46 |

Playing back video

| | |
|-------------------------------|----|
| Playing programmes on the HDD | 47 |
| Playing contents on the media | 51 |
| Operation during play | 53 |
| 4K Networking | 57 |
| Playback menu | 57 |

Editing video

| | |
|-----------------------------|----|
| Deleting/Editing programmes | 60 |
|-----------------------------|----|

Copying video

| | |
|--------------------|----|
| Copying programmes | 64 |
|--------------------|----|

Photo and Music

| | |
|-------|----|
| Photo | 71 |
| Music | 74 |

Network

| | |
|------------------------------------|----|
| Network Service | 76 |
| TV Anywhere | 76 |
| DVB-via-IP Server Function (TV>IP) | 77 |
| Home Networking (DLNA) | 78 |

With Other Equipment

| | |
|------------------------------|----|
| Copying the HD Video (AVCHD) | 82 |
|------------------------------|----|

Other functions

| | |
|----------------------------|----|
| VIERA Link | 83 |
| Software (Firmware) Update | 84 |
| Other operations | 85 |

Setup

| | |
|----------------|----|
| Basic Settings | 88 |
|----------------|----|

Reference

| | |
|-----------------------|-----|
| Troubleshooting guide | 103 |
| Specifications | 112 |
| Licenses | 116 |
| Index | 118 |

Unit care

HDD/USB HDD handling care

- The HDD is a high precision recording instrument and is easily susceptible to damage. Therefore, be careful of the following points while the unit is turned on, especially during operation, otherwise the HDD and the recorded content may be damaged:
 - Do not subject the unit to any vibration and shock.
 - Do not remove the AC mains lead from the household mains socket.
- **The HDD is a temporary storage device**
 - It is recommended to save the recorded content on a disc or to keep the original data or CDs that they were copied from.
 - If you notice a problem with the HDD such as repetitive strange sounds, immediately save (backup) all content and request service. If you continue using the HDD with a problem, the unit or the recorded content will be damaged.
- **If the HDD or USB HDD is damaged, the recorded content cannot be recovered.**

Setup precautions

- **Do not place on anything that generates heat like a Set Top Box, etc.**
- **Place in an area where condensation does not occur. Conditions where condensation may occur**
 - When there is an extreme change in temperature.
 - When there is high humidity or a lot of steam in the room.

In the above situation, **without turning the unit on**, let the unit adjust to the room temperature and wait 2–3 hours until condensation is gone.

- **The unit may breakdown if cigarette smoke or bug spray/vapour, etc. gets inside the unit.**

When moving the unit

Before moving the unit, ensure the disc tray is empty.

- 1 Switch the unit to standby mode. (Wait until “GOOD-BYE” disappears from the display.)
- 2 Remove the AC mains lead from the household mains socket.
- 3 Move only after the unit has come to a complete stop (approx. 3 minutes) in order to avoid subjecting to vibration and shock. (Even after the unit is switched to standby mode, the HDD continues operating for a short time.)

Cleaning

- Wipe with a soft, dry cloth.
- Never use alcohol, paint thinner or benzine to clean this unit.
- Before using chemically treated cloth, carefully read the instructions that came with the cloth.
- Use the lens cleaner (not supplied) to clean the unit’s lens.

When requesting this unit for repair

The registration of the USB HDD may be cancelled in the process of repairing this unit.

You can use the USB HDD again by re-registering, but all recorded content already on the USB HDD will be lost. In such cases, the recorded content (data) cannot be recovered.

To dispose or transfer this unit

This unit may contain private information. Before disposing of or transferring this unit, perform the following to delete the data, including personal or secret information:

- Format HDD (⇒ 94)
- Perform “Shipping Condition” (⇒ 102)

Main unit

Front

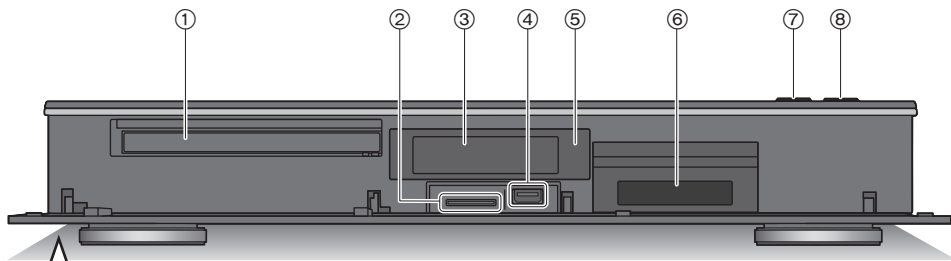

Getting started

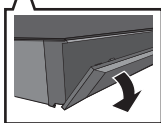

Pull to flip down the front panel.

- ① Disc tray
- ② SD card slot
- ③ Display (⇒ 7)
- ④ USB port (DC 5 V 900 mA)
 - This port supports USB 3.0 Super Speed.
- ⑤ Remote control signal sensor
 - Angle: Approx. 20° up and down, 30° left and right
 - Distance: Within approx. 7 m in front of the unit
- ⑥ CI slot (⇒ 9)
- ⑦ Open/close disc tray
- ⑧ **Standby/on switch** (⏻/⏻)
 - Press to switch the unit from on to standby mode or vice versa. In standby mode, the unit is still consuming a small amount of power.

Inserting or removing media

■ Disc

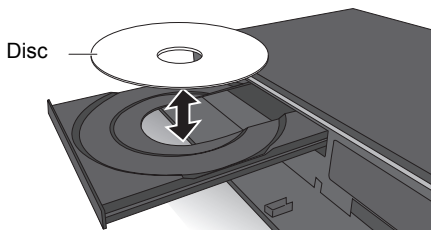

■ SD card/USB device

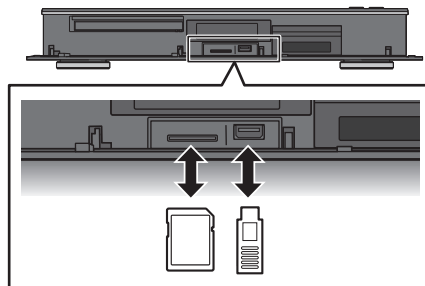

- While writing to/reading from the media, do not switch the unit to standby mode or remove the media. Such action may result in loss of the media contents.
- When inserting the media, ensure that it is facing the right way up.
- When removing the SD card, press on the centre of the card and pull it straight out.
- The USB port on the front side does not support USB HDDs. Connect a USB HDD to the USB port on the rear side. (⇒ 46, Connecting the USB HDD)

Display

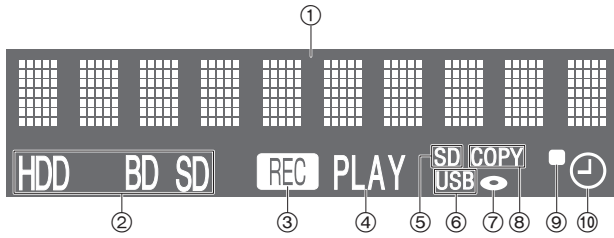

- ① Main display section indicator
 - Messages and other information are displayed. (⇒ 110)
- ② Drive (HDD, BD or SD) indicator
- ③ Recording indicator
 - The indicator will light up while recording.
 - The indicator will blink while recording is paused and before recording starts.
- ④ Playback indicator
- ⑤ SD card slot indicator
- ⑥ USB port indicator
- ⑦ Disc indicator
- ⑧ Copying indicator
- ⑨ Remote control signal indicator
- ⑩ Timer recording indicator
 - This indicator lights up when the timer recording standby or Keyword Recording standby is activated.

Rear

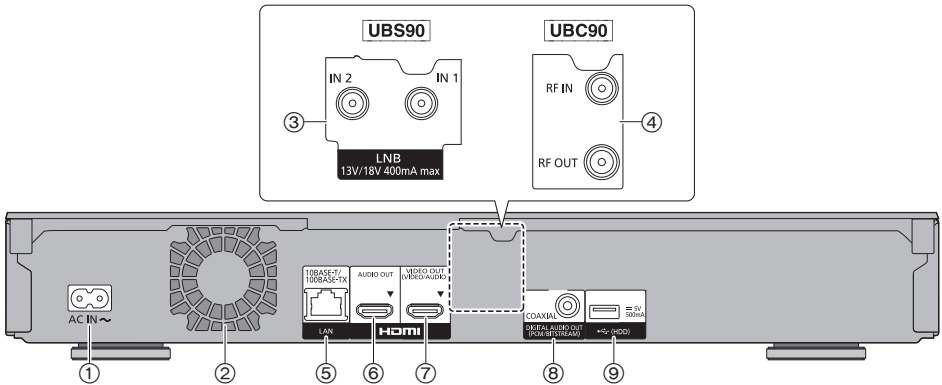

- ① AC IN terminal (~) (⇒ 12, 13)
 - ② Cooling fan
 - ③ LNB IN 1/2 terminal (**UBS90**) (⇒ 13)
 - ④ RF IN/OUT terminal (**UBC90**) (⇒ 12)
 - ⑤ LAN port
 - ⑥ HDMI AUDIO OUT terminal (⇒ 14 to 18)
 - ⑦ HDMI VIDEO OUT terminal (⇒ 14 to 18)
 - ⑧ COAXIAL terminal (⇒ 15 to 18)
 - ⑨ USB port (DC 5 V 500 mA)
 - This port supports USB 2.0 High Speed.
 - Connect a USB HDD to this USB port.
- Class II equipment (The construction of the product is double-insulated.)

Remote Control

Instructions for operations are generally described using the remote control.

Getting started

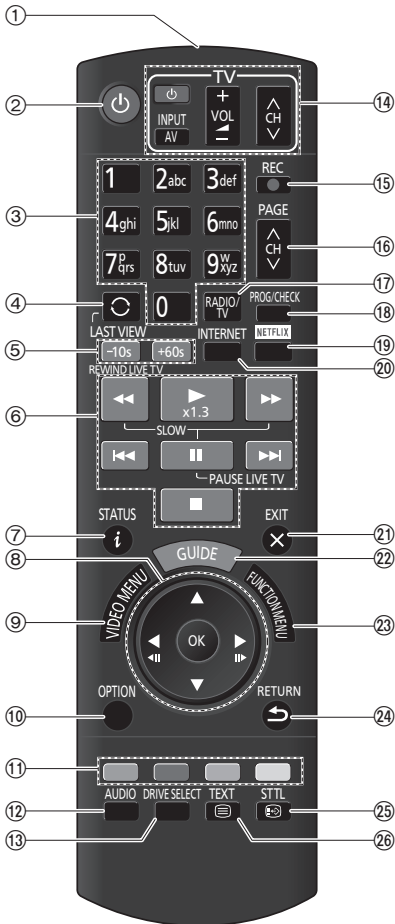

- ① Transmit the remote control signal
 - Point it at remote control signal sensor on this unit. (⇒ 6)
- ② Switch the unit from on to standby mode or vice versa
- ③ Select channels and programme numbers, etc./Enter numbers or characters
- ④ Switch to the previously watched channel (⇒ 30)
- ⑤ Manual skip (⇒ 54)
 - 10s: Skip approx. 10 seconds backward
 - +60s: Skip approx. 1 minute forward
- ⑥ Basic operations for recording and play, REWIND LIVE TV/PAUSE LIVE TV (⇒ 34)
- ⑦ Show Information (⇒ 31, 49, 53)
- ⑧ Selection/OK, Frame-by-frame (⇒ 54)
- ⑨ Show Video Menu, Top Menu, Pop-up Menu (⇒ 47)
- ⑩ Show OPTION menu (⇒ 57, 60, 73)
- ⑪ Colour buttons (red, green, yellow, blue) (Use in accordance with instruction on the screen.)
- ⑫ Select audio (⇒ 31, 54)
- ⑬ Select drive (HDD, Disc, SD or USB)
- ⑭ TV operation buttons (⇒ 19)
- ⑮ Start recording (⇒ 35)
- ⑯ Channel select (⇒ 30)/Change pages in the Video Menu screen etc.
- ⑰ Switching to the radio channel list (⇒ 30)
- ⑱ Show the Timer Recording screen (⇒ 40)
- ⑲ Show NETFLIX screen (⇒ 76)
- ⑳ Show the Network Service screen (⇒ 76)
- ㉑ Exit the menu screen
- ㉒ Show the TV Guide screen (⇒ 33)
- ㉓ Show the FUNCTION MENU screen (⇒ 29)
- ㉔ Return to previous screen
- ㉕ Show subtitles (⇒ 31, 55)
- ㉖ Show Teletext (⇒ 31, 55)

CI (Common Interface) module

Encrypted programmes and broadcasts cannot be viewed with the unit by using standard connections and settings. An appropriate CI module is required to view or record them.

You need a CI module, CAM (Conditional Access Module) together with a certified Smart Card, and a subscription with the corresponding broadcaster.

- If not viewing/recording an encrypted broadcast, you do not need to insert the CI module.

Insert the CI module into the CI slot of this unit.

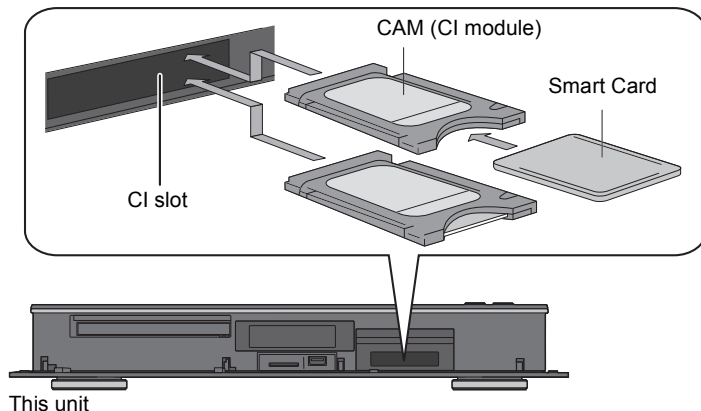

This unit allows you to record/view/play an encrypted programme when automatic decryption is enabled. (Recording may not be possible, depending on the broadcaster.)

See “Notes for recording of an encrypted broadcast”. (⇒ 37)

UBC90 **DVB-T2**

To view freenet TV (Germany only)

freenet TV provides pay television broadcasting services for DVB-T2.

Some freenet TV broadcasts and programmes may be encrypted. A supported CAM and a separate subscription are required to view them. Refer to the website of freenet TV for more details.



- Turn off the unit before you insert or remove the CI module.
- Insert the CAM and the Smart Card with the correct direction.
- Point the CI module at the front side of this unit, and insert it carefully.
- For more details, see the manual of the CAM and Smart Card, or consult the dealer.

About CI Plus compatible broadcast

"CI Plus" is a technical specification that imposes contents protection, etc.

CI Plus contents protection

When the CI Plus compatible broadcast is recorded, the programme may be contents protected. There are following types of the contents protection depending on the broadcast:

- **Copying not restricted**

Depending on the programme, you can copy/move only to USB HDD, BD-RE, BD-R, or DVD-RAM (CPRM compatible discs only).

- **One generation copy is permitted**

You can copy to BD-RE, BD-R or DVD-RAM (CPRM compatible discs only) only once.

- The original programme will be deleted.
- You cannot copy from the copied BD-RE, BD-R or DVD-RAM (CPRM compatible discs) to HDD or another disc.

When the picture quality is changed, the original programme will be deleted.

-  icon will appear on the Video Menu screen. (⇒ 48)

- **Copying is prohibited**



You cannot copy/move to the USB HDD or disc. The content of these media may also have the following playback restrictions.

- Retention limit (⇒ right)
- Content License (⇒ right)

Retention limit



There are some programmes for which the playback will be disabled after a predetermined time.

(e.g., Permitted playback period is 90 minutes after recording.)

- When the programme does not have playback period,  icon will appear on the Video Menu screen after decrypting. (⇒ 48)
- When the programme has playback period,  or  icon will appear on the Video Menu screen after decrypting. (⇒ 48)

Content License

Playing back a programme with this restriction requires a CAM with a playback licence for it.

- The number of times the programme can be played back may also be limited.
- When the programme does not have playback period,  icon will appear on the Video Menu screen after decrypting. (⇒ 48)
- When the programme has playback period,  icon will appear on the Video Menu screen after decrypting. (⇒ 48)

Parental Control

Playing back a programme with this restriction requires a CAM and enter the PIN code.

-  icon will appear on the Video Menu screen. (⇒ 48)

Connection

3D programmes or 4K images can be played back when this unit is connected to 3D or 4K compatible terminal of a 3D or 4K compatible TV.

- Before making any connections, please disconnect all the units from AC power.
(Connect the AC mains lead after making all connections.)
- Use the High Speed HDMI cables. Non-HDMI-compliant cables cannot be utilized.
- When the unit is not to be used for a long time
To save power, unplug it from the household mains socket. This unit consumes a small amount of power, even when the unit is in standby mode. (⇒ 112)

■ Enjoying 4K output

- To enjoy images in 4K (50p/60p), you need an HDMI cable that supports 18 Gbps.
When outputting 1080p or 24p (4K) signal, please use HDMI cables 5.0 meters or less.
It is recommended that you use Panasonic's HDMI cable.
- **If you connect this unit to a 4K-compatible TV and perform "Easy Setting", 4K (50p/60p) will be automatically selected. (⇒ 21)**
- To view broadcasts, programmes or Ultra HD Blu-ray content in 4K/HDR format, connect the unit to the HDMI terminal of a TV that supports HDCP2.2, 4K (50p/60p) 4:4:4, and HDR signals that meet these standards.
- To watch HLG broadcasts in their original picture quality, connection to an HLG-compatible TV is required.

■ To enjoy broadcasts, programmes or Ultra HD Blu-ray discs that support HDR (High Dynamic Range)

If you see a message about compatibility with HDR during playback of a broadcast, programme or Ultra HD Blu-ray disc, please check your TV settings as follows:

Typically, the message will inform you that this unit is not connected to a TV compatible with HDR.

- 1 If you are using a Panasonic TV compatible with 4K and HDR released in 2015 or 2016, (DX900/DX800/DX780/DX750/DX730/DX700 series etc.), please check your TV settings as follows.
 - Switch the TV to the HDMI input.
 - Press "MENU" button of your TV remote control
 - Select "HDMI HDR Setting" in "Setup"
 - Select "On" in "HDMI HDR Setting"
- 2 If you use a TV not from Panasonic, compatible with 4K and HDR, please refer to the operating instructions of the TV.
- 3 When you play back a HDR broadcast, programme or disc on a TV without HDR capability, the broadcast, programme or disc can be played back (in non-HDR quality) even if the message appears.

To the CATV terminal or the Aerial

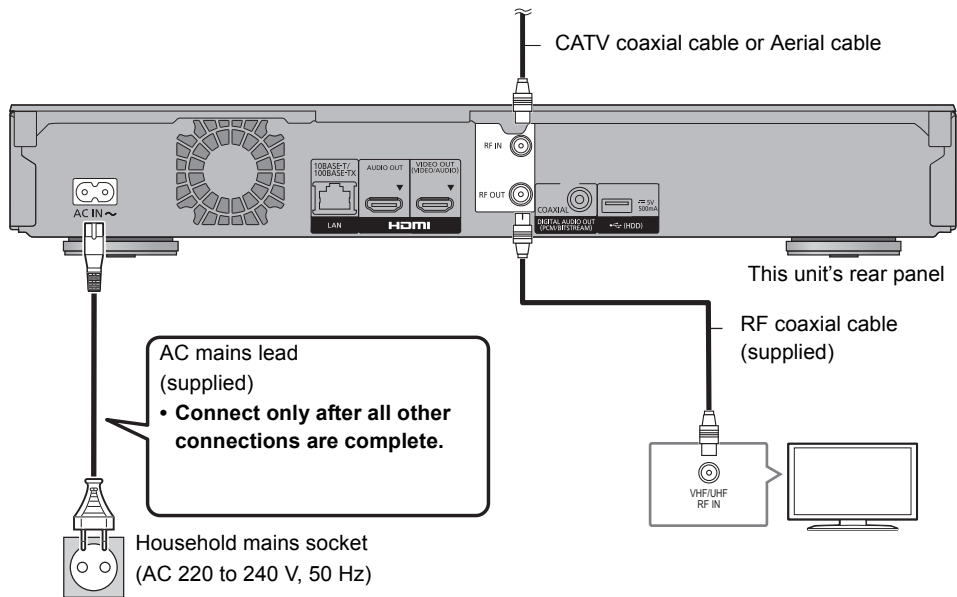

Getting started

HDMI cable connection (⇒ 14 to 18)



- Keep the RF coaxial cables as far away as possible from other cables.
- Switchover from DVB-T to DVB-T2 is scheduled. For details, check the relevant announcements made by broadcast stations. (Germany only)

The following three connection methods are available. Choose a method suited to your environment.

(A) Using a single cable router:

You can record three programmes simultaneously.

- Attach the splitter (supplied) to LNB IN 1 and LNB IN 2 terminals, then connect satellite cable to the splitter.

(B) Using a multi switcher:

You can record two programmes simultaneously.

- Connect both LNB IN 1 and LNB IN 2 to the satellite dish.

(C) Connecting a satellite cable directly:

You can record only one programme at a time.

- Connect LNB IN 1 terminal to the satellite dish.

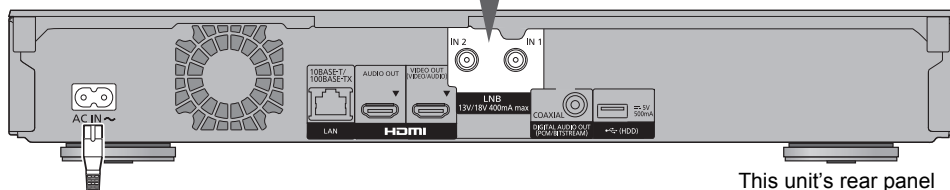
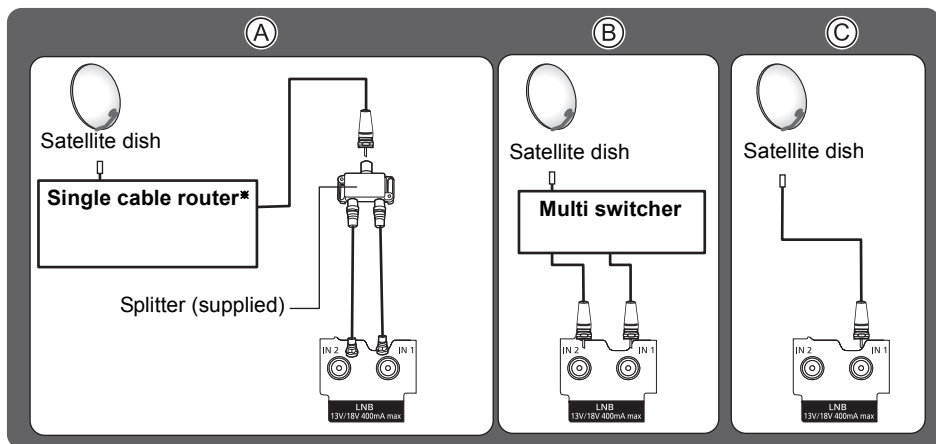

This unit's rear panel

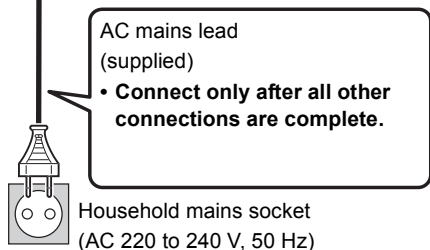

※ Check the version of the single cable router. (⇒ 22)

HDMI cable connection (⇒ 14 to 18)

Enjoying video and audio with a 4K-compatible TV

e.g., **UBC90**

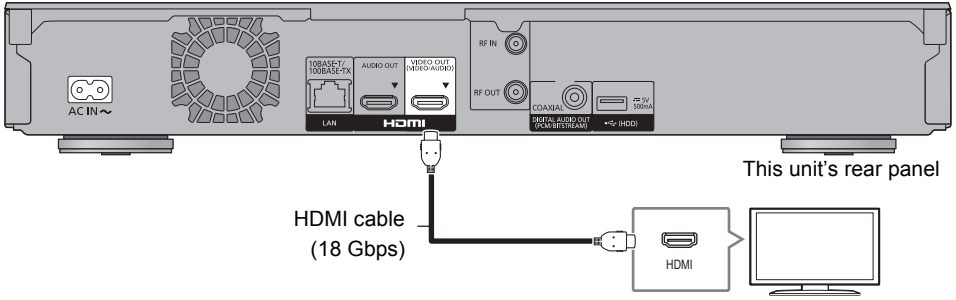

Getting started

Setting

Set the following items in the setup menu (⇒ 88):

- Set “HDMI(VIDEO) Output Mode” to “Automatic (Video Only / Video+Audio)”. (⇒ 97)
- Set “HDMI(AUDIO) Output Mode” to “Audio Only”. (⇒ 57)

Enjoying video with a 4K-compatible TV and audio with an amplifier

You can enjoy richer sound by using the HDMI AUDIO OUT terminal.
(Audio is output in high resolution.)

e.g., **UBC90**

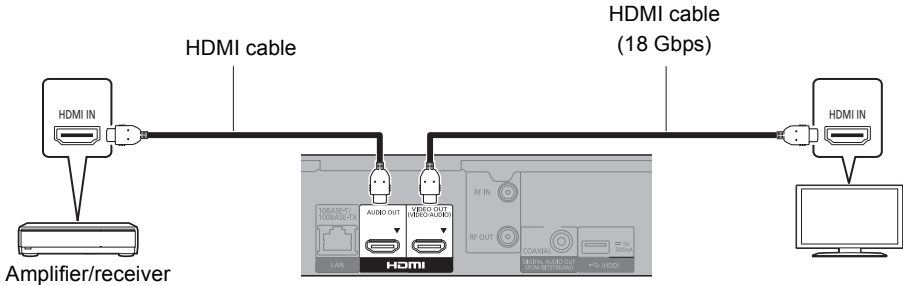

Setting

Set the following items in the setup menu (⇒ 88):

- Set “HDMI(VIDEO) Output Mode” to “Automatic (Video Only / Video+Audio)”. (⇒ 97)
- Set “HDMI(AUDIO) Output Mode” to “Audio Only”. (⇒ 97)
- To enjoy audio with a TV
Set “HDMI(VIDEO) Output Mode” to “Video+Audio”. (⇒ 97)



- The HDMI AUDIO OUT terminal is not compatible with 4K output and the VIERA Link (⇒ 83).

Enjoying video with a 4K-compatible TV and audio with a 4K-compatible amplifier

e.g., **UBC90**

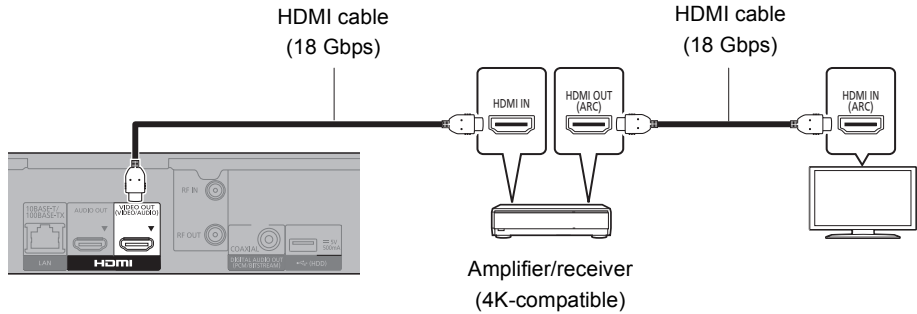

Setting

Set the following items in the setup menu (⇒ 88):

- Set "HDMI(VIDEO) Output Mode" to "Automatic (Video Only / Video+Audio)". (⇒ 97)
- Set "HDMI(AUDIO) Output Mode" to "Audio Only". (⇒ 97)



About ARC:

When using a TV or an amplifier/receiver that does not display "ARC" on the HDMI terminal, it is necessary to connect the TV and the amplifier/receiver with a digital audio cable to enjoy the TV audio on the amplifier/receiver.

Enjoying audio with an amplifier connected to the COAXIAL terminal

e.g., **UBC90**

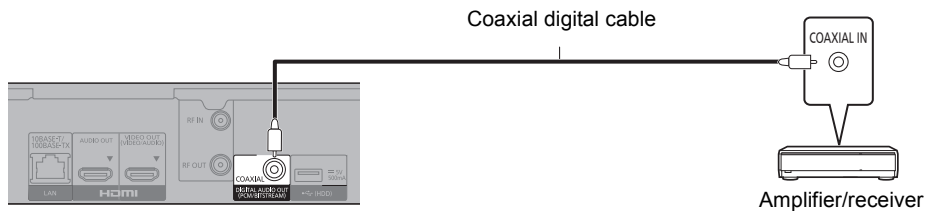

Setting

Set the following items in the setup menu (⇒ 88):

- Set "HDMI(VIDEO) Output Mode" to "Automatic (Video Only / Video+Audio)". (⇒ 97)
- Set "HDMI(AUDIO) Output Mode" to "Audio Only". (⇒ 97)
- To enjoy audio with an amplifier connected to the COAXIAL terminal
Set "Audio Output" to "Off" in "Advanced Settings". (⇒ 97)

Connecting an amplifier to a 4K-compatible TV

3D or 4K images can be played back when this unit is connected to a 3D or 4K compatible TV.

- This connection only supports up to 5.1ch.
- To connect a TV and amplifier with an HDMI cable, connecting terminals on both the TV and amplifier must be ARC-compatible. (⇒ 15, “About ARC”)

e.g., **UBC90**

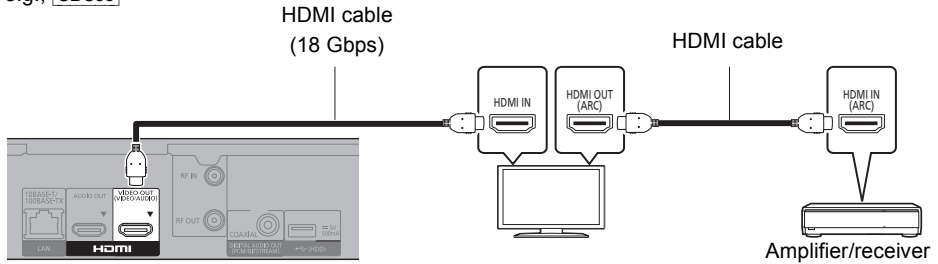

Setting

Set the following items in the setup menu (⇒ 88):

- Set “HDMI(VIDEO) Output Mode” to “Automatic (Video Only / Video+Audio)”. (⇒ 97)
- Set “HDMI(AUDIO) Output Mode” to “Audio Only”. (⇒ 97)
- Set “Audio Output” to “Off” in “Advanced Settings”. (⇒ 97)

Enjoying video with a 4K-compatible TV in combination with an amplifier connected to the HDMI AUDIO OUT terminal and another amplifier connected to the COAXIAL terminal

e.g., **UBC90**

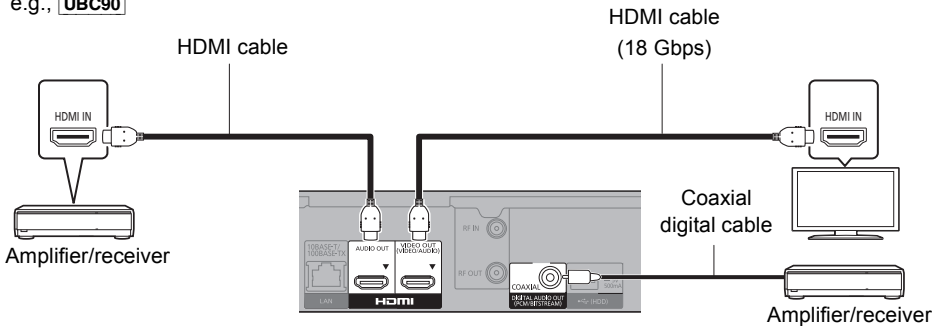

Setting

Set the following items in the setup menu (⇒ 88):

- Set “HDMI(VIDEO) Output Mode” to “Automatic (Video Only / Video+Audio)”. (⇒ 97)
- Set “HDMI(AUDIO) Output Mode” to “Audio Only”. (⇒ 97)
- To enjoy audio with an amplifier connected to the COAXIAL terminal
Set “Audio Output” to “Off” in “Advanced Settings”. (⇒ 97)
- To enjoy audio with a TV
Set “HDMI(VIDEO) Output Mode” to “Video+Audio”. (⇒ 97)



- It is not possible to simultaneously output audio from both the amplifier connected to the HDMI AUDIO OUT terminal and the other amplifier connected to the COAXIAL terminal.

Enjoying video with a 4K-compatible TV in combination with a 2K-compatible projector and an amplifier that is connected to the COAXIAL terminal

e.g., **UBC90**

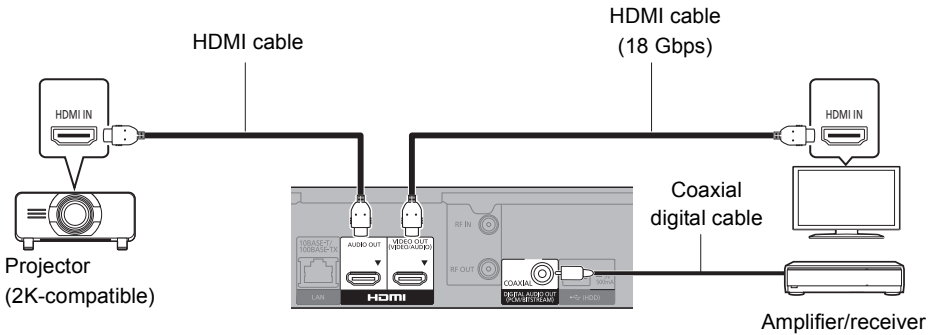

Setting

Set the following items in the setup menu (⇒ 88):

- Set “HDMI(VIDEO) Output Mode” to “Automatic (Video Only / Video+Audio)”. (⇒ 97)
- Set “HDMI(AUDIO) Output Mode” to “Audio Only”. (⇒ 97)
- To enjoy audio with an amplifier connected to the COAXIAL terminal
Set “Audio Output” to “Off” in “Advanced Settings”. (⇒ 97)
- To enjoy audio with a TV
Set “HDMI(VIDEO) Output Mode” to “Video+Audio”. (⇒ 97)
Set “Audio Output” to “On” in “Advanced Settings”. (⇒ 97)
- To enjoy video with a projector
Set “HDMI(AUDIO) Output Mode” to “Video+Audio”. (⇒ 97)
(It is not possible to output 3D, 4K or HDR content from the HDMI OUT terminal when “Video+Audio” is selected.)

Enjoying video with a 4K-compatible TV in combination with a 2K-compatible projector and an amplifier that is connected to the HDMI AUDIO OUT terminal and another amplifier that is connected to the COAXIAL terminal

e.g., **UBC90**

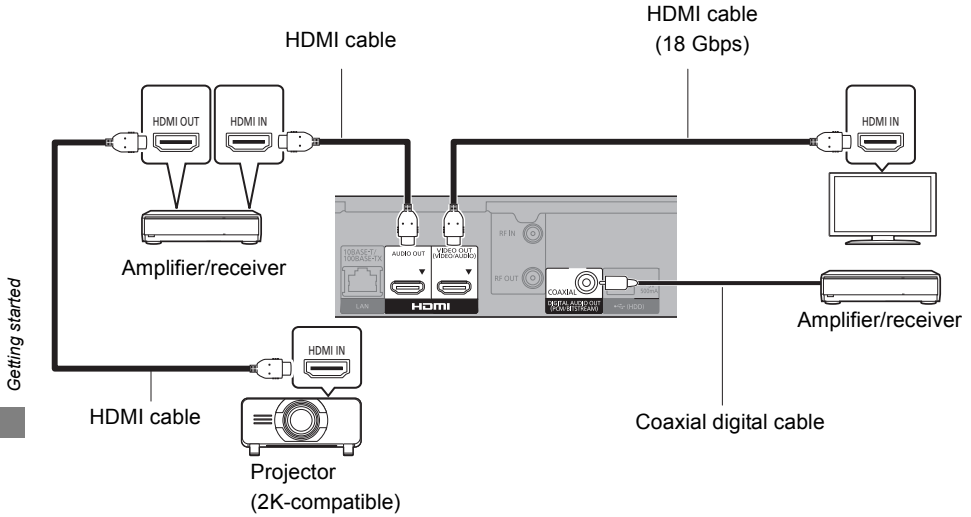

Setting

Set the following items in the setup menu (⇒ 88):

- Set “HDMI(VIDEO) Output Mode” to “Automatic (Video Only / Video+Audio)”. (⇒ 97)
- Set “HDMI(AUDIO) Output Mode” to “Audio Only”. (⇒ 97)
- To enjoy audio with an amplifier connected to the COAXIAL terminal
Set “Audio Output” to “Off” in “Advanced Settings”. (⇒ 97)
- To enjoy audio with a TV
Set “HDMI(VIDEO) Output Mode” to “Video+Audio”. (⇒ 97)
- To enjoy video with a projector
Set “HDMI(AUDIO) Output Mode” to “Video+Audio”. (⇒ 97)
(It is not possible to output 3D, 4K or HDR content from the HDMI OUT terminal when “Video+Audio” is selected.)



- It is not possible to simultaneously output audio from both the amplifier connected to the HDMI AUDIO OUT terminal and the other amplifier connected to the COAXIAL terminal.

Network connection

When this unit is connected to the network, you can enjoy network functions (Ultra HD Blu-ray Playback, DLNA function, Network Service, TV Anywhere, etc.).

For details about connection method, refer to the instructions supplied with the connected equipment.

After you make the LAN cable/Wireless LAN connection, the network setting is needed. (⇒ 22, Easy Network Setting)

LAN cable connection

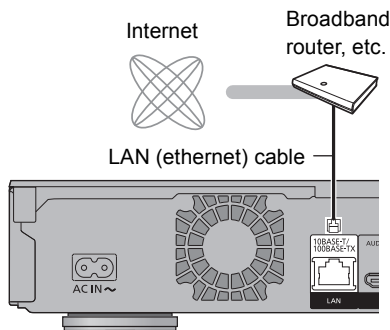

- Use category 5 or above straight LAN cables (STP) when connecting to peripheral devices.

Wireless LAN connection

About wireless LAN connection (⇒ 22, Easy Network Setting)



- The unit is not compatible with public wireless LAN services.

Settings

TV operation buttons

The TV can be operated from the TV operation buttons of the remote control.

- Perform the setting if you cannot operate the TV with the TV operation buttons.

While pressing [TV ⏻], enter the code with the number buttons.

Manufacturer and Code No.

| Manufacturer | Code | Manufacturer | Code |
|--------------|----------------|--------------------|-------------------|
| Panasonic | 01/02/03/04 | NEC | 36 |
| AIWA | 35 | NOBLEX | 33 |
| AKAI | 27/30 | NOKIA | 25/26/27/60/61 |
| BEKO | 05/71/72/73/74 | NORDMENDE | 10 |
| BENQ | 58/59 | OLEVIA | 45 |
| BRANDT | 10/15 | ONWA | 30/39/70 |
| BUSH | 05 | ORION | 05 |
| CENTREX | 66 | PEONY | 49/69 |
| CURTIS | 05 | PHILCO | 41/48/64 |
| DAEWOO | 64/65 | PHILIPS | 05/06/46 |
| DESMET | 05 | PHONOLA | 05 |
| DUAL | 05 | PIONEER | 37/38 |
| ELEMIS | 05 | PROVIEW | 52 |
| FERGUSON | 10/34 | PYE | 05 |
| FINLUX | 61 | RADIOLA | 05 |
| FISHER | 21 | SABA | 10 |
| FUJITSU | 53 | SALORA | 26 |
| FUNAI | 63/67 | SAMSUNG | 32/42/43/65/68 |
| GOLDSTAR | 05/50/51 | SANSUI | 05 |
| GOODMANS | 05 | SANYO | 21/54/55/56 |
| GRADIENTE | 36 | SCHNEIDER | 05/29/30 |
| GRUNDIG | 09 | SEG | 05/69/75/76/77/78 |
| HITACHI | 05/22/23/40/41 | SELECO | 05/25 |
| IRRADIO | 30 | SHARP | 18 |
| ITT | 25 | SIEMENS | 09 |
| JVC | 17/30/39/70 | SINUDYNE | 05 |
| KDS | 52 | SONY | 08 |
| KOLIN | 45 | TCL | 31/33/66/67/69 |
| KONKA | 62 | TELEFUNKEN | 10/11/12/13/14 |
| LG | 05/50/51 | TEVION | 52 |
| MAG | 52 | THOMSON | 10/15/44 |
| METZ | 05/28/79 | TOSHIBA | 16/57 |
| MITSUBISHI | 05/19/20/47 | WHITE WESTINGHOUSE | 05 |
| MIVAR | 24 | YAMAHA | 18/41 |



- If your TV brand has more than one code listed, select the one that allows correct operation.
- If the brand of your TV is not listed or the code number is invalid for your TV, this remote control is not compatible with your TV.

UBC90**Easy Setting**

The tuner in this unit is compatible with digital Cable broadcast services and digital terrestrial broadcast services.

- In these operating instructions,

DVB-C: indicates features applicable to digital cable broadcasts (DVB-C).

DVB-T (**DVB-T2**): indicates features applicable to digital terrestrial broadcasts (DVB-T).
[Switchover from DVB-T to DVB-T2 is scheduled. (Germany only)]

- This unit can receive only one of the two services at a time.

- 1** Turn on the TV, then select the appropriate AV input to suit the connections to this unit.
- 2** Press [**⏻**] on the remote control or [**⏻/I**] on this unit.
 - The Easy Setting will start at the initial power on.
- 3** Select language, then press [**OK**].
- 4** Select country, then press [**OK**].
- 5** Set "TV Signal Selection".
 - Select "Digital Cable Channels" or "Digital Terrestrial Channels", then press [**OK**].

① **DVB-C**

Select the channel number allocation, then press [**OK**].

- For Germany and Austria:
We recommend selecting "Preset Channel Number".
- For Switzerland:
We recommend selecting "Operator's Channel Number (LCN)".



- To change channel allocation, restart Auto Setup in Basic Settings menu and change channel number allocation selection. (⇒ 89)
- If channel is not found, restart Auto Setup in Basic Settings menu. (⇒ 89)
- Switchover from DVB-T to DVB-T2 is scheduled. After switchover to DVB-T2, perform Update Channel List to update channels. (Germany only)

② **DVB-C**

Select "Start Auto Setup", then press [**OK**].

- **Scan Mode**

- └ **Quick**

- └ **Full**

- **Frequency**

- └ **Auto**

The preset frequency will be automatically used.

- └ **Manual**

Enter the frequency specified by your cable provider with number buttons.

- **Network ID**

- └ **Auto**

The preset Network ID will be automatically used.

- └ **Manual**

Enter the Network ID specified by your cable provider with number buttons.



- Frequency and Network ID settings may be necessary depending on the cable provider. For details, consult the cable provider.

- 6** Auto Setup will start automatically. (This operation may take some time.)

DVB-C

When tuning is completed, press [**OK**].

- 7** Clock will be set automatically. If the clock setting screen appears, set the time manually (⇒ 102, Clock).
- 8** Set Quick Start to "On", "Off" or "Timer Setting for Quick Start", then press [**OK**].

When "Easy Setting has been completed." appears, Easy Setting is complete.

When connected to a 4K (50p or 60p)-compatible TV

When connected to a 4K (50p or 60p)-compatible TV, you can set the video output format.

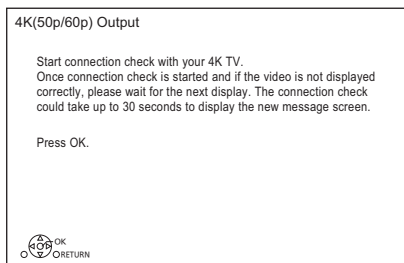

Follow the on-screen instructions to set the format.



- To reconnect this unit to a 4K (50p or 60p)-compatible TV after connecting this unit to a 2K-compatible TV and completing "Easy Setting", set "4K(50p/60p) Output" to "4K(50p/60p) 4:4:4" or "4K(50p/60p) 4:2:0". (⇒ 96)

To stop partway

Press [RETURN .

To restart setup or change TV signal type (⇒ 89, Auto Setup)



To confirm that channels have been tuned correctly (⇒ 33, Using Channel List)



- If tuning is cancelled partway through, it may not be possible to receive the channels. Restart setup again.

UBS90

Easy Setting

- 1 Turn on the TV, then select the appropriate AV input to suit the connections to this unit.
- 2 Press [] on the remote control or [/I] on this unit.
 - The Easy Setting will start at the initial power on.
- 3 Select language, then press [OK].
- 4 Select country, then press [OK].
- 5 Select the search mode, then press [OK].
- 6 Select "DiSEqC" (Dual Tuner), "Single Cable System" or "DiSEqC" (Single Tuner) then press [OK].

Auto Setup starts.

These operations (Searching Satellite and Searching Channels) may take some time. After tuning has been completed, clock will be set automatically. If the clock setting screen appears, set the time manually (⇒ 102, Clock).

- 7 Set Quick Start to "On", "Off" or "Timer Setting for Quick Start", then press [OK].

When "Easy Setting has been completed." appears, Easy Setting is complete.

When connected to a 4K (50p or 60p)-compatible TV (⇒ left)

To stop partway

Press [RETURN .

To restart setup (⇒ 91, Auto Setup)

To confirm that channels have been tuned correctly (⇒ 33, Using Channel List)



- If tuning is cancelled partway through, it may not be possible to receive the channels. Restart setup again.

When selecting “Single Cable System” in Step 6.

- 1 Select the “Single Cable Version”.

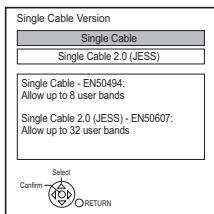

- Select the setting that matches the version of your equipment.
- Check the Single Cable Version setting in advance.

e.g.,

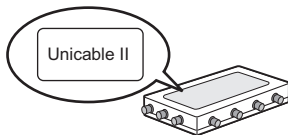

- 2 Make the settings of user band.

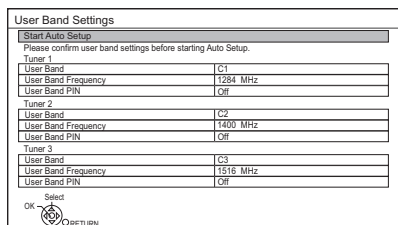

• User Band

You can set C1 to C8. (If you have selected “Single Cable 2.0 (JESS)”, a value from C1 to C32 can be set.) Set to a User Band not used by any other device.

- When only one User Band of the Router is assigned, set “Tuner 2” and “Tuner 3” to “OFF”.

Note that you will not be able to record two programmes simultaneously.

When two User Bands of the Router are assigned, set “Tuner 3” to “OFF”.

Note that you will not be able to record three programmes simultaneously.

• User Band Frequency

Set the User Band Frequency with number buttons.

• User Band PIN

If the single cable router requires a PIN to access an user band, enter the PIN.

- For details, read the manual of the single cable router, etc.

- 3 Select “Start Auto Setup”, then press [OK].



- Set User Band as required.
- Refer to the operating instructions for your single cable router for information about each item.

Easy Network Setting

After completing “Easy Setting”, you can continue with “Easy Network Setting”.

Follow the on-screen instructions to establish your connection settings.

Select “Wired” or “Wireless”, then press [OK].

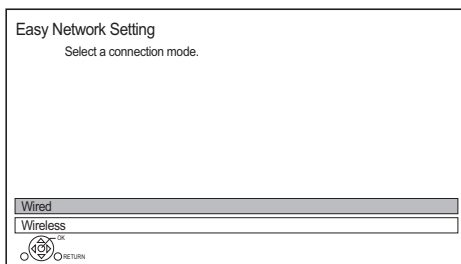

LAN cable connection (“Wired”)

Follow the on-screen instructions to apply your connection settings.

Wireless LAN connection (“Wireless”)

Before beginning wireless connection setup

- Obtain your network name (SSID*1).
- If your wireless connection is encrypted, please be sure that you know your encryption key.
- The default SSID*1, Password (Key) etc., may be printed on the router.

e.g.,

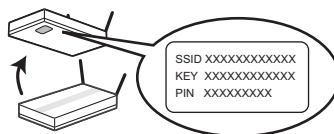

Then follow the on-screen instructions and apply the settings.

Search for wireless network:

The available wireless networks will be displayed. Select your network name and press [OK].

- If your Network name is not displayed, search again by pressing the red button on the remote control.
- Stealth SSID*2 will not be displayed. Enter manually by using "Wireless Settings". (⇒ 98)
- If your wireless network is encrypted, Encryption Key Input Screen will be displayed.
Input the encryption key of your network.

WPS (PUSH button):

If your Wireless router supports WPS (PUSH button), you can easily perform the settings by pressing WPS button on it.

WPS (Wi-Fi Protected Setup™) is a standard that facilitates settings relating to the connection and security of wireless LAN devices.

- 1 Press the green button on the remote control.
- 2 Press WPS button or corresponding button of Wireless router until the lamp starts flashing.
 - For details, refer to the operating instructions of Wireless router.
- 3 Press [OK].

e.g.,

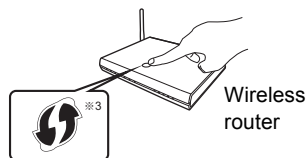

To restart Easy Network Setting

- 1 Press [FUNCTION MENU]. (⇒ 29)
- 2 Select "Basic Settings" in "Setup", then press [OK].
- 3 Select "Easy Network Setting" in "Network", then press [OK].

To redo settings individually

If "Easy Network Setting" did not work properly or when you change the settings individually, perform the following steps:

- 1 Press [FUNCTION MENU]. (⇒ 29)
- 2 Select "Basic Settings" in "Setup", then press [OK].
- 3 Select "Network Settings" in "Network", then press [OK].
- 4 Refer to "Network Settings". (⇒ 98)

Check security before using Home Network function

If you set "Home Network function" to "On", all connected devices on the same network can access this unit. Ensure that the router for your home network has adequate security system to prevent unauthorised access.



- Refer to the operating instructions of the hub or router.
- If you set "Home Network function" or "TV Anywhere" to "On", the setting for "Quick Start" is fixed to "On".
- Do not use this unit to connect to any wireless network for which you do not have usage rights.
During automatic searches in a wireless network environment, wireless networks (SSID) for which you do not have usage rights may be displayed; however, using these networks may be regarded as illegal access.
- After performing network settings on this unit, the settings (encryption level, etc.) of the Wireless router might change. When you have trouble getting online on your PC, perform the network settings on your PC in accordance with the settings of Wireless router.
- Please be aware that connecting to a network without encryption may result in the content of the communication being illegitimately viewed by a third party, or the leaking of data such as personal or secret information.

*1 SSID:

An SSID (Service Set IDentification) is a name used by wireless LAN to identify a particular network. Transmission is possible if the SSID matches for both devices.

*2 Depending on the settings of the wireless router, its SSID may not be found. For details, refer to the operating instructions for the wireless router.















*3 The wireless router compatible with Wi-Fi Protected Setup™ may have the mark.







HDD and media information

For more details, refer also to the specifications. (⇒ 112)

Recordable/playable contents

(-: Impossible)

| Media type | Standard symbol | Recordable contents | Playable contents |
|---|---|--|---|
| Built-in hard disk drive (HDD)  | HDD | <ul style="list-style-type: none"> • Video • AVCHD/AVCHD 3D • MKV • MP4 • MPEG2 | <ul style="list-style-type: none"> • JPEG • MPO (3D photo) • AAC • ALAC • DSD • FLAC • MP3 • WAV • WMA |
| External hard disk drive (USB HDD) (⇒ 27)  | USB HDD | - | <ul style="list-style-type: none"> • AVCHD/AVCHD 3D^{#2,3} • MKV • MP4 • MPEG2 • JPEG • MPO (3D photo) • AAC • ALAC • DSD • FLAC • MP3 • WAV • WMA |
| Ultra HD Blu-ray  |  | - | <ul style="list-style-type: none"> • Video |
| BD-Video  | | | |
| BD-RE BD-RE DL  |  | BD-RE | <ul style="list-style-type: none"> • Video • AVCHD/AVCHD 3D • JPEG • MPO (3D photo) |
| BD-R BD-R DL  | | | |
| DVD-Video^{#4}  |  | DVD-V | <ul style="list-style-type: none"> • Video |
| DVD-RAM  | | | |
| DVD-R DVD-R DL   |  | DVD-R | <ul style="list-style-type: none"> • Video |
| | | | <ul style="list-style-type: none"> • AVCHD^{#2} • MKV • JPEG • MPO (3D photo) • AAC • ALAC • DSD • FLAC • MP3 • WAV • WMA |

| Media type | Standard symbol | Recordable contents | Playable contents |
|--|--|---------------------|--|
| DVD-RW  |  | DVD-RW | • Video – |
| +R/+R DL | | +R | • AVCHD ^{※2} – |
| +RW | | +RW | • Video – |
| Audio CD (CD-DA)  |  | CD | • Music – |
| CD (including CD-R/RW) | | | • MKV • JPEG • MPO (3D photo) • AAC • ALAC • FLAC • MP3 • WAV • WMA |
| USB memory |  | USB | • AVCHD/AVCHD 3D ^{※2,3} • MKV • MP4 • MPEG2 • JPEG • MPO (3D photo) • AAC • ALAC • DSD • FLAC • MP3 • WAV • WMA |
| SD Cards  |  | SD | • MP4 • MPEG2 • JPEG • MPO (3D photo) |
| | | | – |

- ※1 It cannot be recorded directly. (Only compatible with copying from the built-in HDD)
- ※2 Recorded with AVCHD format compatible devices (Panasonic video camera, etc.). It may not be able to play back, add, or edit depending on the device.
- ※3 It cannot be played back directly from the USB HDD or USB memory. Playback is possible by copying to the built-in HDD. (⇒ 82)
- ※4 Includes finalised DVD-R, DVD-R DL, DVD-RW, +R and +R DL.



- **+RW** This unit cannot record to 8X Speed +RW disc.
- With certain recording states and folder structures, the play order may differ or playback may not be possible.
- It may not be possible to play the above media in some cases due to the type of media, the condition of the recording, the recording method, and how the files were created.

Information about contents

■ Broadcast Recordings

Numbers of programmes that can be recorded:

| Media | Maximum programmes |
|------------------------|--------------------|
| HDD | 3000 |
| BD-RE, BD-R | 200 |
| DVD-RAM, DVD-R, DVD-RW | 99 |
| +R, +RW | 49 |

- Maximum numbers of programmes are including recordings of HD CAMCORDER.

■ HD CAMCORDER Recordings

MPEG-4 AVC/H.264 (based on AVCHD)

Numbers of programmes that can be recorded:

| Media | Maximum programmes |
|-------------|--------------------|
| HDD | 3000 |
| BD-RE, BD-R | 200 |

- Maximum numbers of programmes are including recordings of Broadcast.

■ Photo files

Compatible pixels:

Between 34×34 and 8192×8192 pixels

Sub sampling: 4:2:2, 4:2:0

(Motion JPEG is not supported.)

Maximum numbers of contents:

| Media | Folders | Files |
|--|---------|-------|
| HDD | — | 20000 |
| BD-RE, BD-R, DVD-RAM, DVD-R, +R, CD-R, CD-RW, USB device, SD | 500 | 10000 |

■ Video files/Audio files

Numbers of contents that can be copied to internal HDD:

| Contents | Maximum numbers of folders and files |
|----------|--------------------------------------|
| Video | 20000 |
| Audio | 20000 |

USB device:

- Each folder can store up to 1000 files.
- We recommend that you limit the depth of folder trees to about five levels.
- Bit rate up to 100 Mbps/resolution up to 3840×2160 50p/60p, 4096×2160 50p/60p. [MP4, MKV and MPEG2 (TS) only]

About extension of files

| File format | Example of file extension |
|---|---|
| MKV (Compression methods Video: H.264, HEVC Audio: AAC, PCM, Vorbis, FLAC) | “.mkv” |
| | (Subtitle text files) |
| | “.srt” |
| | “.sub” “.txt” |
| MP4 (Compression methods Video: H.264, HEVC Audio: AAC, LPCM ^{#2}) | “.mp4” “.mov” |
| MPEG2 (TS/PS) (Compression methods Video: MPEG2, H.264 ^{#1} , HEVC ^{#1} Audio: AAC ^{#1} , Dolby Digital) | “.mpg” “.mpeg” “.m2ts” “.mts” “.ts” |
| JPEG | “.jpg” |
| MPO | “.mpo” |
| AAC | “.m4a” |
| ALAC | “.m4a” |
| DSD | “.dsf” |
| | “.dff” |
| FLAC | “.flac” |
| MP3 | “.mp3” |
| WAV | “.wav” |
| WMA | “.wma” |



^{#1} TS only

^{#2} Unsupported for contents with HEVC video codec



- The video file and subtitle text files are inside the same folder, and the file names are the same except for the file extensions.
- Some files may not be played back even if they have these extensions.

Recording mode (Picture Quality)

| Picture Quality | DR | HG/HX/HE/HL/HM | XP/SP/LP/FR ^{#1} |
|---|---|---|--|
| Feature | Programmes can be recorded in a nearly perfect broadcasted state. | Recording can be done with reduced recording volume in High definition (HD) quality ^{#2} . | Recording can be done with reduced recording volume in Standard definition (SD) quality. |
| Recordable media |  |  |  |
| Multiple audio Audio description | Record all multiple audio | Record only one audio ^{#3} | |
| Subtitles / Teletext | Can be recorded | Can be recorded (only one subtitle or teletext) ^{#4} | |
| Surround audio | Surround audio as the broadcast | Surround audio produced by conversion of broadcast audio format | Stereo audio |

^{#1} FR (Flexible Recording Mode):

The unit automatically selects the best possible recording rate between XP mode and LP mode.

^{#2} The SD quality programme cannot be converted to HD quality.

^{#3} You cannot select during play whether it activates or deactivates.

^{#4} You cannot select during play whether it appears or disappears.

Approximate recording times

Refer to "Recording modes (picture quality) and approximate recording times". (⇒ 113)

Notes

Notes for the USB device

You can use an external HDD (USB HDD) in the following two ways (A single HDD cannot handle those two ways simultaneously), and a USB memory for data files.

• For recorded programmes

Moving programmes in the built-in HDD to a USB HDD to save the capacity of the built-in HDD.

- The USB HDD must first be registered on this unit. (⇒ 46)
- USB HDDs with a capacity smaller than 160 GB or greater than 3 TB cannot be used.
- Do not connect additional HDDs using a USB hub.
- For details about connection method, refer to the instructions supplied with the USB HDD.

• For data files

Playing back MP4, JPEG, MP3, etc. in a USB device with this unit.

- The USB device must be formatted in FAT12, FAT16, FAT32 or NTFS file system.
- The USB device over 2 TB is not usable.



- The USB port on the rear of the unit supports USB 2.0 High Speed and the USB port on the front supports to USB 3.0 Super Speed.
- This unit does not recognise USB HDDs other than those in which the size of one sector is 512-bytes or 4096-bytes. (For details, consult the dealer of your USB HDD.)
- This unit supports USB mass storage device class.
- This unit does not guarantee connection with all USB devices.
- For playback of 4K videos stored on a USB device, use USB 3.0 port on front of the unit and USB device conforming to USB 3.0.

Notes for the disc

• Region management information

The unit can play back BD-Video/DVD-Video discs of the following regions codes, including "ALL":



• Disc recorded on another device

- It may be necessary to finalise the disc, create Top Menu or close the session on the equipment used for recording to play on this unit.

• **DVD-RW** Recorded in DVD Video Recording (DVD-VR) format

- This unit can play back and copy to HDD.
- This unit does not support editing or recording.
- It is possible to record and edit with DVD-Video (DVD-V) format by formatting discs with this unit.

- Recording may not be possible to discs which were used for recording on other equipment.

• Play on other players

• **BD-RE** **BD-R** When these discs cannot be played back on other Blu-ray Disc players, etc., change the picture quality to play them back. (e.g., programmes recorded in HE-AAC audio format) (⇒ 61, Picture Quality Change)

• **DVD-R** **DVD-RW** **+R** Finalisation is needed. (⇒ 86)

• **+RW** If the disc failed to play on other equipment, we recommend you create a Top Menu (⇒ 87).

• **DVD-R** The disc created in AVCHD format can only be played back on AVCHD compatible equipment.

• Regarding 8 cm Disc

This unit cannot record or edit the 8 cm disc. Only playback or copy to the HDD is possible.

• Discs that cannot be played

- DVD-RAM in a cartridge
- 2.6 and 5.2 GB DVD-RAM, 12 cm
- DVD-Audio
- Super Video CD, Super Audio CD, Video CD



- Operation and sound quality of CDs that do not conform to CD-DA specifications (copy control CDs, etc.) cannot be guaranteed.

Notes for the SD cards

• Compatible SD card

- SD Memory Card
(from 8 MB to 2 GB, FAT12 and FAT16 formats)
- SDHC Memory Card
(from 4 GB to 32 GB, FAT32 format)
- SDXC Memory Card
(48 GB, 64 GB, exFAT format)

• Using miniSD card or microSD card

Mini-type and micro-type cards can also be used, but must be used with adaptor cards (optional).



- If the SD card is formatted on other equipment, the time necessary for recording may be longer or the card may not be able to be used on this unit. In these cases, format the card on this unit.

Media handling

- Do not touch the recorded surface of the discs or the terminal surface of the SD cards.
- Wipe with a damp cloth and then wipe dry.

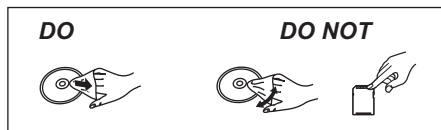

- Do not attach labels or stickers to discs.
- Do not use disc cleaning sprays, benzine, thinner, static electricity prevention liquids or any other solvent.
- Do not use the following discs:
 - Discs with exposed adhesive from removed stickers or labels (rental discs, etc.).
 - Discs that are badly warped or cracked.
 - Irregularly shaped discs, such as heart shapes.
- Do not expose the terminals of the SD card to water, garbage or other strange things.

FUNCTION MENU screen

You can easily access the desired functions, such as playback, timer recording, the unit's settings etc. via the FUNCTION MENU.

1 Press [FUNCTION MENU].

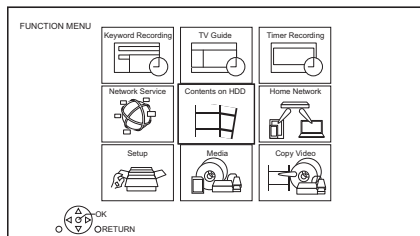

2 Select the item, then press [OK].

FUNCTION MENU list

- **Keyword Recording** (⇒ 43)
- **TV Guide** (⇒ 33)
- **Timer Recording** (⇒ 40)
- **Network Service** (⇒ 76)
- **Contents on HDD**
 - Recorded Programmes (⇒ 47)
 - Video (AVCHD) (⇒ 47)
 - Video (MP4 / MKV) (⇒ 51)
 - Photo (⇒ 71)
 - Music (⇒ 75)
- **Home Network**
 - Miracast (⇒ 81)
 - DLNA Client (⇒ 79)
 - Media Renderer (⇒ 80)
 - Wi-Fi Direct (⇒ 80)
- **Setup**
 - Basic Settings (⇒ 88)
 - You can change the unit's settings of DVB Tuning, Sound, Display, Connection, Network etc.
 - HDMI Connection Settings (⇒ 96)
 - TV Anywhere (⇒ 76)
 - Wallpaper
 - Personalize a background of the FUNCTION MENU.
 - To select from among "Photo", register photo in advance. (⇒ 71)
 - BD-Video Data Management (⇒ 52)
- **Media**
 - Disc
 - SD Card
 - USB device
 - USB HDD
- **Copy Video**
 - Copy Menu (⇒ 66)
 - Copy Video (AVCHD) to DVD-R (⇒ 70)

Watching broadcasts

Watching UHD/HDR broadcasts

Preparation

To watch HLG broadcasts in their original picture quality, connect the unit to an HLG-compatible TV. (⇒ 11)

Press [CH ^ v] to select the channel.

- You can also select the channel by the following operations.
 - Using number buttons
 - Using Channel List (⇒ 33)
 - Using TV Guide (⇒ 33)
 - Using channel information (⇒ 31)

You can watch UHD/HDR broadcasts with this unit.

UHD (4K) broadcasts and channels are indicated by the “UHDTV” or “UHD” icon.

e.g., channel information (⇒ 31)

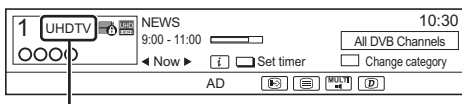

HD broadcasts are indicated as “HDTV”.

e.g., TV Guide (⇒ 33)

| TV Guide | Landscape | TUE 03.01.2017 8:05 | Category: All DVB Channels |
|-------------|------------------|---------------------|----------------------------|
| 8:00 - 9:45 | Skillful workman | UHD | |
| 1 0000 | Skillful workman | Penguin | |
| 2 0000 | Kitten | House dog | WIFI |
| 3 0000 | Vacation | Hunting | |
| 4 0000 | Pampas grass | News | Top run |
| 5 0000 | News | Comedy | |

HD broadcasts are indicated by the “HD” icon.

To switch to the channel you have previously watched

Press [LAST VIEW].

- This function will work only for the channels you have watched for more than 10 seconds.

To switch to the radio channels or to the all channels

Press [RADIO/TV].



- Selection of channel is made easy by creating a Favourite of the channels. (⇒ 88, 91, Favourites Edit)

To update the channel list

Refer to “Update Channel List”. (⇒ 90, 91)

Shutdown of DVB-T broadcasting (Germany only)

When DVB-T signals are shut down, a message will appear, directing you to the Update Channel List. Follow the on-screen instructions to update the list.

After Update Channel List is performed, check to see if your timer recordings are still set. Timer recordings registered to deleted channels cannot be recorded. In addition, check the Favourites list. (⇒ 88)



- For details, check the relevant announcements made by broadcast stations.

Using channel information

While watching a programme

Press [STATUS ⓘ].

Channel information appears.

e.g.,

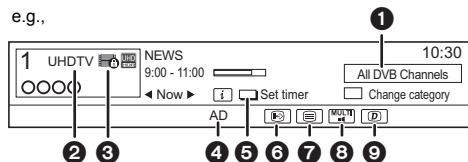

- 1 Current Category
- 2 TV service type
e.g., UHDTV: 4K programme
HDTV: 2K programme
- 3 Encrypted broadcast
- 4 Audio Description
- 5 Set timer (⇒ 41, Timer recording from channel information)
- 6 Subtitle
- 7 Teletext
- 8 Multiple audio/Sub Channel
- 9 Data service (Catch Up TV) (⇒ 32)

To show detailed information

Press [STATUS ⓘ] again.

To hide the information screen

Press [EXIT ⊗].

To change Category

Press the blue button.

To add your favourite channels

- 1 Press [OPTION].
- 2 Select "Digital TV Menu", then press [OK].
- 3 Select "Favourites Edit", then press [OK].
- 4 Refer to "Favourites Edit". (⇒ 88, 91)

To switch between the current programme and the next programme

Press [◀, ▶].

To switch to another channel

Press [▲, ▼], then press [OK].

To show subtitle

When "Ⓢ" appears in channel information

Press [STTL Ⓢ].

- Press again to hide subtitle.

To change subtitle language

- 1 Press [OPTION].
- 2 Select "Subtitle Language" in "Digital TV Menu", then press [OK].
- 3 Select the desired language.
 - Press [EXIT ⊗] to exit the screen.



- Some subtitle contents can be displayed using Teletext. (⇒ below)

To show the Teletext

When "☰" appears in channel information

- 1 Press [TEXT ☰].
 - When the Teletext of data service is displayed, press [TEXT ☰] again.
- 2 Use [▲, ▼, ▶, ◀], number buttons or colour buttons, etc. according to on-screen instructions.



- You can change the display mode. (⇒ 96, Teletext)

Switching audio

Press [AUDIO].

- Audio will switch according to the contents of the programme every time it is pressed.

To listen to the Audio Description

Audio Description adds an additional soundtrack to describe events on screen (narration) and aids understanding and enjoyment, particularly for visually-impaired viewers.

When “AD” appears in channel information (⇒ 31)

- 1 Press [OPTION].
- 2 Select “Audio Description” in “Digital TV Menu”, then press [OK].
- 3 Select “Audio Description” and set to “Automatic”.
- 4 Select “Volume”, then adjust the volume with [◀, ▶].



- Audio Description may not be available depending on the type of audio format.
- When “Dolby D / Dolby D + / Dolby True HD”, or “HE-AAC” is set to “Bitstream”, the Audio Description may not work. Set them to “PCM” (⇒ 95, Digital Audio Output).
- You can also set “Audio Description” active in the Setup menu. (⇒ 90)

To use data service (Catch Up TV)

To use the data service function (Catch Up Service), network connection and settings are necessary. (⇒ 19, 22)

- Set “HbbTV Setting” to “On”. (⇒ 90)

To select the data service, follow the on-screen instructions. (e.g., “Press colour button.” etc.)



- Operations may vary depending on the broadcaster.
- For information about other disclaimers. (⇒ 115, About Network Service in “Disclaimer”)

To select the contents in the broadcast

When a programme includes audio signals etc., you can select signals.

- 1 Press [OPTION].
- 2 Select “Digital TV Menu”, then press [OK].
- 3 Select “Multi Audio” or “Sub Channel”, then press [OK].
- 4 Select the item.

If this unit requests a PIN

Enter the PIN with the number buttons by following the on-screen instructions.

- **If you decide on a PIN, make a note it in case you forgot it.**
- PIN (except CAM's) can be changed via “PIN Entry”. (⇒ 102)
- For CAM's PIN, refer to your CAM's operating instructions.

If encrypted channels do not appear

To watch an encrypted broadcast, insert the CI module into the CI slot. (⇒ 9)

- Set “Common Interface”. (⇒ 98)

Using Channel List

You can select from the list of channel names.

- 1 Press [OK].

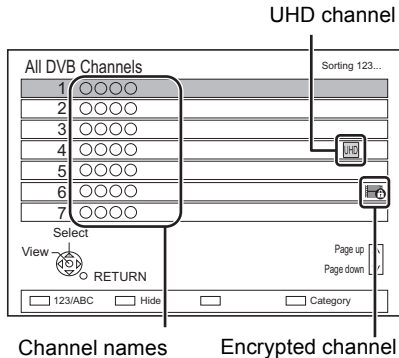

- Red: Sort the channel
- Blue: Change the category
- Green: Skip unwanted channels (⇒ below)

- 2 Select the channel, then press [OK].

To skip unwanted channels

The channel is skipped next time you select the channel.

- 1 While the channel list screen is displayed, select the unwanted channel.
- 2 Press the green button.
- 3 Press [OK].

UBC90

- **DVB-T** **DVB-T2** You cannot skip channels.



- You can select the channel you have skipped with the number button that corresponds to the channel.
- When you want to restore the skipped channel, edit the channel list. (⇒ 89, 91)

To edit the channel list

Refer to “Channel List”. (⇒ 89, 91)

Using TV Guide

- 1 Press [GUIDE].
e.g. Landscape view

| TV Guide | | Landscape | | TUE 03.01.2017 8:05 | | Category: All DVB Channels | |
|-------------|------|------------------|--------------|---------------------|--------------|----------------------------|---|
| 8:00 - 9:45 | | Skillful workman | | UHD | | ① | |
| TUE 03.01 | 8:00 | 8:30 | 9:00 | 9:30 | 10:00 | 10:30 | ▷ |
| 1 | ○○○○ | Skillful workman | | | Penguin | | |
| 2 | ○○○○ | Kitten | House dog | | | Will | |
| 3 | ○○○○ | Vacation | Hunting | | | | |
| 4 | ○○○○ | Pampas grass | | News | Top run | | |
| 5 | ○○○○ | News | Com/Shopping | | Area 91 | | |
| 6 | ○○○○ | Venus | | Moon | | | |
| 7 | ○○○○ | Construction | | | Hippopotamus | | |
| 8 | ○○○○ | Great river | Mr. Otter | | Dodge | | |

OK RETURN Portrait/Landscape Information Page Up Page Down
 Timer Rec. +24 hours Keyword Recording

- 2 Select the programme, then press [OK].
- 3 Select “View”, then press [OK].

To change TV Guide view

Press [GUIDE] to switch between “Landscape” view and “Portrait” view.

Page up/down

Press [CH ^ v].

To view a programme list for another day

Press the green button (Previous) or the yellow button (Next).

To see programme information

Press [STATUS ①].

To retrieve the programme data for the area where data have not been acquired

Select the area, then press [STATUS ①].

To set a timer recording using the TV Guide System (⇒ 39)

To search the programmes (⇒ 40)

REWIND LIVE TV/PAUSE LIVE TV

This unit temporarily saves a live TV programme you are watching with this unit's tuner on HDD.

REWIND LIVE TV

You can rewind live TV programme to the point where temporary save has started (up to 1.5 hours).

While watching TV
Press [◀◀] to rewind.

PAUSE LIVE TV

You can pause live TV programme and restart watching from the paused position.

While watching TV
Press [⏸] to pause.

- The maximum amount of the temporary save is 1.5 hours.

To resume watching TV

Press [▶ × 1.3].

- You can perform search or Quick View, etc.
- If temporary save stops (⇒ right), playback will be performed by that point.

To stop REWIND LIVE TV or PAUSE LIVE TV

- 1 Press [■].
- 2 Select "Yes", then press [OK].

To hide the display information

Press [EXIT ⊗].



- Temporary save stops in the following cases:
 - When switching to other channels or other screen
 - When the unit has started recording using all tuners
 - When performing PAUSE LIVE TV or REWIND LIVE TV for more than 8 hours (This may vary depending on the HDD free space.)
- These functions do not work in the following cases:
 - When the clock is not set
 - When setting clock manually (Contents protected programme (Retention limit) only) (⇒ 10)
 - When all tuners are being used to record programmes
 - While copying
 - While watching a programme being recorded
 - When a radio programme is selected
 - While watching an encrypted programme

Display information

While pausing or rewinding a broadcast:

Press [STATUS ⓘ].

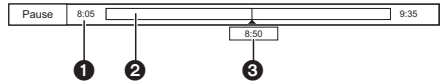

- Press [STATUS ⓘ] again.

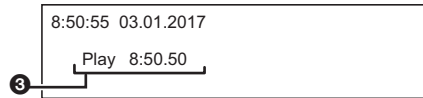

- 1 The time that you can rewind the live programme.
- 2 The amount of time temporarily saved on HDD.
- 3 The time of the current playback position.

Recording TV programmes



- This unit can record three programmes being broadcasted at the same time.*
- About CI Plus restriction (⇒ 10)
- Notes for recording of an encrypted broadcast (⇒ 37)

Preparation

You can change the recording mode (picture quality) (⇒ 36)

- 1 Select the channel to record.**
- 2 Press [REC ●].**
Recording will start.
- 3 Select “Automatic Stop”, then press [OK].**
 - **One touch recording (OTR)**
Recording stops automatically when the programme ends.

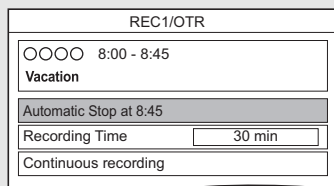

* **UBS90**

The number of programmes that can be simultaneously recorded varies depending on the setup environment. (⇒ 13)



- If a timer recording reaches its start time when all tuners are being used for recording, the recording (OTR) of one of the programmes terminates.
- Data service will not be recorded.
- Following contents or media cannot be played back while recording.
 - video file
 - photo
 - USB HDD (For data files, ⇒ 27) and USB memory
- Copying cannot be performed while recording.
- When “Automatic Standby after OTR” is set to “On” (⇒ 101), this unit is turned to standby mode if this unit is not operated for approximately 5 minutes after completing “Automatic Stop” or “Recording Time”.
- The picture quality of encrypted programmes is not changed until they are decrypted. (⇒ 37)

Recording UHD/HDR programmes

This unit can record UHD/HDR programmes. UHD (4K) programmes are significantly larger than HD (2K) programmes in data size. If you keep recording UHD (4K) programmes, free space on the HDD may be used up quickly. Before this happens, however, you can copy them to an external USB HDD.

- You can save them to a disc. (⇒ 64)



- For details about recording times, refer to “Recording modes (picture quality) and approximate recording times”. (⇒ 113)

To set the recording time

- 1 Select "Recording Time" or "Continuous recording" in step 3 (⇒ 35).

Recording Time:

You can set the length of recording time from 30 minutes to 4 hours.

- You can select the recording time with [◀, ▶].
- 2 Press [OK].

To change the recording mode (picture quality)

This unit can record programmes in DR mode and then automatically change their recording mode (picture quality) to another setting while in standby mode.

- 1 Press [OPTION].
- 2 Select "Recording Mode".
- 3 Select the recording mode (picture quality), then press [OK].

- Recording mode (Picture Quality) (⇒ 27)

e.g., **UBC90**

| Recording Mode (Picture Quality) | |
|------------------------------------|--|
| HDD Remain | HD <input type="radio"/> h <input type="radio"/> m (DR) |
| | UHD <input type="radio"/> h <input type="radio"/> m (DR) |
| | DR(Original) |
| | HG |
| | HX |
| High Definition | HE |
| | HL |
| | HM |
| | XP |
| Standard Definition | SP |
| | LP |

- The recording mode (picture quality) set here is used as the default value for the next recording.

To change the recording mode (picture quality) after recording in DR mode (⇒ 61, "Picture Quality Change")

To check to see if the recording mode (picture quality) change is finished (⇒ 62)

To cancel the recording mode (picture quality) change (⇒ 62)



- Programmes in the original picture quality (DR mode) will be deleted after their recording mode (picture quality) is changed.
- It takes about the same amount of time as recording to change the recording mode (picture quality).
- When the HDD does not have enough remaining space, the recording mode (picture quality) change function does not operate.
- A recording mode (picture quality) change stops when this unit is turned on. The process will start from the beginning again after the unit is switched to standby mode.
- Even if you change the recording mode (picture quality) of a programme, its audio, subtitle and Audio Description settings will remain the same as those at the start of recording.
- When the recording mode (picture quality) of a programme recorded in DR mode is changed, teletext recorded with the programme will be lost.
- If you switch to a recording mode other than DR mode, UHD programmes (4K) will be down-converted to 2K programmes.

Operation during Recording

To check the recording programme

Press [STATUS].

e.g., While recording three programmes simultaneously

| | | |
|-----|---------------|---|
| HDD | REC1/OTR AUTO | Recording programme displayed on the TV |
| 1 | ○○○○ | |
| 5 | ○○○○ REC2 | Recording programme not displayed on the TV |
| 6 | ○○○○ REC3 | |

Recording programme not displayed on the TV

To stop recording

Press [■].

When recording one programme:

If the following screen appears

| Stop Recording | |
|--|-----------------------------------|
| 1 | ○○○○ Vacation |
| Recording of this programme is in progress. Stop this recording ? | |
| <input type="button" value="Yes"/> | <input type="button" value="No"/> |

Select "Yes", then press [OK].

When recording three programmes:

Following screen appears

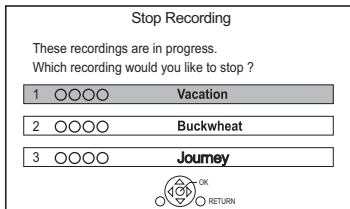

- 1 Select the programme, then press [OK].
- 2 Select "Yes", then press [OK].

To pause recording

After displaying the recording programme, press [II].

- Press again to restart recording.
(A programme is not split into separate programmes.)



- Timer recording programme cannot be paused.

To record three programmes simultaneously

While recording, perform steps 1–3 on page 35.

Simultaneous rec and play

You can play the recording programme from the beginning or the programmes previously recorded to the HDD.

- 1 Press [VIDEO MENU].

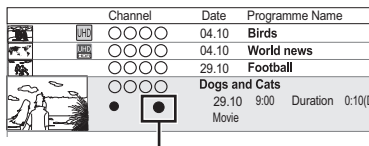

● (red) is displayed on the recording programme.

- 2 Select the programme, then press [OK].

Notes for recording of an encrypted broadcast

This unit allows you to record/view/play an encrypted programme by decryption using a supporting CI module.

Recording of encrypted broadcast

The recording of encrypted broadcasts differs according to the "Recording for Encrypted Channel" (⇒ 93) settings as follows.

| | Supporting CI module is inserted | Supporting CI module is not inserted |
|-------------------|----------------------------------|--------------------------------------|
| Automatic | Record (Decrypted) ^{*1} | Record (Encrypted) |
| Decrypt Recording | Record (Decrypted) | Recording impossible |

^{*1} Depending on the specifications of the CI module, the broadcast may be recorded in the encrypted form.

Encrypted programmes simultaneous recording/viewing/playing

When "Automatic" is selected

The unit can record three encrypted programmes simultaneously. Programmes are normally recorded in a decrypted form, but depending on the state of the unit, they may be recorded in an encrypted form.

When "Decrypt Recording" is selected

The unit cannot record programmes without a CI module, which is necessary for decryption.

- To record three programmes simultaneously, select "Automatic".

The following tables show some of the operation patterns of the unit when you try to simultaneously record/view/play two programmes ("A" and "B") that compete for the same CI module.

When "Automatic" is selected

| Programme | "A" | "B" |
|---|-----------------------------------|--------------------------|
| While recording programme "A", start recording programme "B". | Record (Decrypted) | Record (Encrypted) |
| While viewing/playing programme "A", start timer recording programme "B". | Viewing/playing possible | Record (Encrypted) |
| While recording programme "A", view/play programme "B". | Record (Encrypted ^{*2}) | Viewing/playing possible |

^{*2} When you start viewing/playing programme "B", the decrypted recording of programme "A" switches to encrypted recording. You need to decrypt programme "A" to play it.

When "Decrypt Recording" is selected

| Programme | "A" | "B" |
|---|----------------------------|----------------------------|
| While recording programme "A", start recording programme "B". | Record (Decrypted) | Recording impossible |
| While viewing/playing programme "A", start timer recording programme "B". | Viewing/playing impossible | Record (Decrypted) |
| While recording programme "A", view/play programme "B". | Record (Decrypted) | Viewing/playing impossible |

Recording

Encrypted programmes

Programmes recorded in encrypted form () have the following restrictions:

- The encrypted programme can be played back, but it does not mean that it is decrypted and saved in the decrypted form.
- Depending on the programme, it may not be possible to play back/decrypt after recording.
- There are restrictions on the playback and editing of encrypted programmes.
- To copy an encrypted programme, decryption must be performed.

Decryption



Decryption is performed when the unit is turned off. It will take about the same time as the recorded duration.

"COPY" on the front panel display remains lighted during decryption.

It is also possible to decrypt manually

Refer to "Programme Decryption". (⇒ 62)



- To decrypt, insert the CI module into the CI slot (⇒ 9). During decryption, do not remove the CI module from this unit.
- The programme before decryption will be deleted once decryption is completed.
- When the HDD does not have enough remaining space, decryption will not start.
- This function is stopped when this unit is turned on. Decryption will start from the beginning again once the unit is turned off.
- When a decryption fails,
 - decrypt the programme manually. (⇒ 62)
 - if the screen icon changes from " to "", the programme is copy protected by the CI Plus CAM. Editing of the programme is not possible except for deletion. When you encounter this problem, delete the programme.

Timer recording



- You can enter up to 32 programmes within a month in advance. (Each daily or weekly programme is counted as one programme.)
- This unit can record three programmes being broadcasted at the same time.*
- About CI Plus restriction (⇒ 10)
- Notes for recording of an encrypted broadcast (⇒ 37)

Preparation

You can change the recording mode (picture quality) (⇒ 36)

- 1 Press [GUIDE].**
TV Guide screen appears.
- 2 Select the programme, then press the red button.**
The timer icon “⊖” (red) is displayed.
 - If on-screen instructions are displayed, follow them.

* **UBS90**

The number of programmes that can be simultaneously recorded varies depending on the setup environment. (⇒ 13)



- Some broadcasters may not send programme information. When programme information is not displayed correctly, use manual timer recording. (⇒ 40)
- The receipt of the TV Guide data via Set Top Box is not possible.
- You can set the start and finish time to make the timer recording work successfully. (⇒ 93, Timer Record Start Buffer, Timer Record Stop Buffer)

To use TV Guide system (⇒ 33)

Operation during Recording (⇒ 36)

To edit the timer programme (⇒ 42)

To edit the timer recording on the TV Guide screen

- 1 Select the programme to edit, then press the red button.
- 2 Select “Timer Rec Edit”, then press [OK].
- 3 Go to step 3 on page 40, “Manually programming timer recording”.

To cancel a timer recording on the TV Guide screen

- 1 Select the programme to cancel, then press the red button.
- 2 Select “Timer Rec Cancel”, then press [OK]. (“⊖” disappears)

If “Overlapped Timer Recording” screen appears

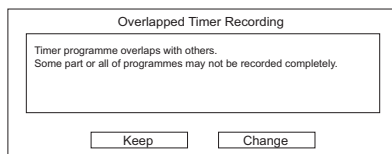

To resolve an Overlapped Timer Recording

- 1 Select “Change”, then press [OK].
- 2 Follow the on-screen instructions.



Red: Delete programme

Yellow: Exit (Overlapping is not resolved)

To use Signal Supported Recording

The recording's start and stop times can be controlled by the broadcaster, e.g. delayed start.

- To use this function, set "Signal Supported" to "ON". (⇒ 41)
- The Signal Supported Recording function may not work if you manually change the start time or the stop time over 10 minutes.



- If the signal is not sent correctly, the recording may lack the beginning or the ending part of the programmes.

To search the programmes

- 1 On the TV Guide screen:
Press [OPTION].
- 2 Select the item below, then press [OK].

Keyword Search

Displays programmes including the input keyword.

- Refer to "Entering text". (⇒ 87)

Programme Type Search

Displays programmes of the selected type. If, for example, you select "Art/Culture", only the programmes related to arts and culture are displayed. Use this search function to find the programme you want to watch quicker.

- Select the programme type, then press [OK].

Category Selection

Displays channels in the selected category. (Radio etc.) You can find the programme you want to watch quicker by narrowing down the channels to be displayed.

- To return to the previous TV Guide list
Select "All DVB Channels".

- 3 Select the programme, then press the red button for timer recording.



- Category may not be assigned correctly depending on the programme information.
- "Keyword Search", "Programme Type Search" and "Category Selection" search the First 250 channels on "All DVB Channels".

Manually programming timer recording

- 1 Press [PROG/CHECK].

| Timer Recording | | Time Remaining | TUE 03.01.2017 8:05 | |
|---------------------|----------|----------------|---------------------------|--|
| | | | HD 314:08 / UHD 157:04 DR | |
| Channel Name | Schedule | Mode | Space | |
| New Timer Programme | | | | |
| | | | | |
| | | | | |
| | | | | |
| | | | | |
| | | | | |

- 2 Select "New Timer Programme", then press [OK].

- 3 Select the items and change the items.
(⇒ 41, Timer recording options)

- 4 Press [OK].
The timer programme is stored.

| Timer Recording | | Time Remaining | TUE 03.01.2017 8:05 | |
|--------------------------|--------------------------|----------------|---------------------------|--|
| | | | HD 314:08 / UHD 157:04 DR | |
| Channel Name | Schedule | Mode | Space | |
| ⊕ ○○○○ Programme Name | WED 04.01 8:00 - 9:00 | DR | OK | |
| New Timer Programme | | | | |
| | | | | |
| | | | | |

To confirm and edit the timer programme (⇒ 42)

Operation during Recording (⇒ 36)



- Signal Supported Recording is disabled when a manually programmed timer recording is set.

Timer recording options

Select the items and change the settings.

e.g., **UBC90**

| Channel | Day/Date | Start | Stop | Mode | Subtitles |
|---------|-----------|-------|------|---------|-----------|
| 1 | WED 07.01 | 8:00 | 9:00 | DR → XP | OFF |

Channel

You can select Category with the red button.

Day/Date

You can select “Date” or “Weekly” by pressing the green button.

Auto Renewal Recording

(Only daily/weekly timer recording)

The unit will record the new programme over the old one.

Press the yellow button.

“Renew : ON” is displayed.

Start/Stop

Press and hold **[▲, ▼]** to alter in 15-minute increments.

Mode

Refer to “To change the recording mode (picture quality)” (⇒ 36).

Subtitles

You can choose whether or not to record subtitles when the picture quality is changed.

(Only when item other than “DR” is selected in “Mode”)

Programme Name

- 1 Select “Programme Name”, then press [OK].
- 2 Refer to “Entering text”. (⇒ 87)

To use Signal Supported Recording

You can choose whether or not to use the Signal Supported Recording function by pressing the blue button.

Timer recording from channel information

You can make timer recording of the current or next programme.

- 1 While watching a programme
Press **[STATUS ⓘ]**.

e.g.,

1 UHDTV NEWS 10:30
9:00 - 11:00
All DVB Channels
Now Set timer Change category
AD

- 2 Display the channel information of a programme to record.
 - Switch the programme with **[◀, ▶]**.
 - Switch the channel with **[▲, ▼]**.
- 3 Press the yellow button.
- 4 Go to step 3 on page 40, “Manually programming timer recording”.

- When the recording mode (picture quality) of a programme recorded in DR mode is changed, teletext recorded with the programme will be lost.
- Data service will not be recorded.
- (Only when recording broadcast in other than DR mode)
This unit can record programmes in DR mode and then automatically change their recording mode (picture quality) to another setting while in standby mode. The recording mode (picture quality) of encrypted programmes will be changed after they are decrypted.
- When you programme successive timer recordings to start, about last 1 minute of earlier programme will not be recorded.
- Timer recording will not start while:
 - copying a programme by using Copy (Keep Picture Quality) [to a finalised disc or a disc with a Top Menu (+RW)]
 - copying a programme in Copy (Change Picture Quality) mode
 - changing the recording mode (picture quality) of a programme in "Picture Quality Change" (Only when "Now" is selected)
 - copying HD Video (AVCHD) from USB device or SD card.
 - copying video/photos/music files
 - formatting
 - finalising/creating Top Menu
- When "Pure Sound mode" is activated, timer recording does not start during playback of BD-Video, DVD-Video or music CD. (⇒ 93)
- When the recording mode (picture quality) of a programme recorded in DR mode is changed, its new audio and subtitle language settings will be determined by the following settings:
 - "Multi Audio" and "Subtitles" in "Preferred Language" (⇒ 90, 92)
 - "Audio Description" (⇒ 90, 92)

To confirm and edit a timer programme

1 Press [PROG/CHECK].

e.g.,

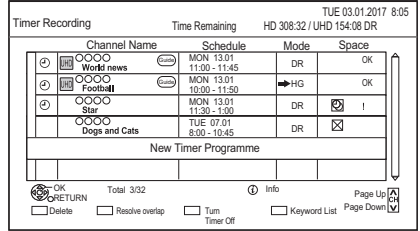

2 Select the programme, then perform the operations.

- Red: To delete a timer programme
- Green: To resolve an overlap timer programme
 - The overlapped timer recording list will appear. (⇒ 39)
- Yellow: To deactivate a timer programme
 - The timer icon "⊖" will change from red to grey.
 - Press the yellow button again to activate timer recording standby. (The timer icon "⊖" will change to red.)
- [STATUS ⊕]: Show programme information

To edit a timer programme

- 1 Press [OK].
- 2 Change the timer recording options.
 - Refer to "Timer recording options". (⇒ 41)
- 3 Press [OK].

To exit the timer recording list

Press [EXIT ⊗].

| | |
|--------|---|
| | Red: Timer recording standby is activated. Grey: Timer recording standby is deactivated. |
| | Currently recording programme |
| | A part or all of the programme will not be recorded since the programme is overlapping. |
| | The HDD is full. |
| | Copy-protected programme It was not recorded. |
| | The recording of the programme was not completed because of some reason. |
| | Auto Renewal Recording is set (⇒ 41). |
| | Signal Supported Recording (⇒ 41) |
| | Displayed if timer recording of two encrypted programmes is overlapping. (When "Recording for Encrypted Channel" is set to "Decrypt Recording" only) (⇒ 93) A part or all of the programme will not be recorded since the encrypted programme is overlapping. |
| OK | Displayed if the recording can fit in the remaining space |
| --> | Daily or weekly timer programme is set. |
| (Date) | • The timer remains active until the date indicated below -->. |
| ! | It may not be possible to record because: - there is not enough space left. - the number of possible programmes has reached its maximum. (⇒ 26) - programmes are deactivated, etc. |
| | • Programmes to be recorded with Keyword recording (⇒ right) are not displayed. |

Keyword Recording



The unit can find programmes that include specified keywords from programme names and programme information on TV Guide, and record the programmes automatically.

- This unit can record three programmes being broadcasted at the same time.*
- Restrictions on CI Plus and encrypted programmes that apply when recording programmes also apply to this function. (⇒ 10, 37)
- Notes on timer recording (⇒ 42)

- 1 On the TV Guide screen:
Select the programme for keyword recording and press the blue button.
- 2 Select the items and change the items if necessary.
 - Refer to "Keyword Recording conditions". (⇒ 44)

e.g.,

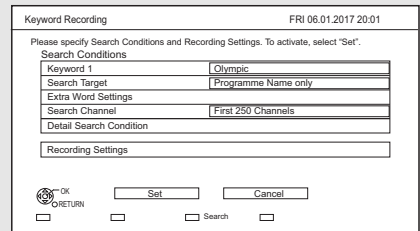

- 3 Select "Set", then press [OK].
- 4 Press [OK].
The Keyword Recording icon "⊕" (blue) is displayed on the TV Guide screen.

* **UBS90**

The number of programmes that can be simultaneously recorded varies depending on the setup environment. (⇒ 13)



- Programmes that are set to be recorded automatically with Keyword Recording are not displayed on the Timer Recording confirmation screen. (⇒ 42) (⇒ 44, "To display the list of programmes found with the set keyword")
- When a search brings up too many programmes, we recommend revising the search settings.
- On the TV Guide screen, up to 128 programmes are displayed with the Keyword Recording icon "⊕" (blue).

Keyword Recording conditions

Search Conditions:

Keyword 1-16

Input the keyword to be registered.

- Refer to "Entering text". (⇒ 87)
- Default keyword is the programme title selected on the TV Guide screen.
If the programme title includes its episode number, etc., delete the number before registering the title.

Search Target

Select the search target.

Extra Word Settings

- 1 Add up to two keywords and two excluded words to refine search conditions.
- 2 Select "Set", then press [OK].

Search Channel

The Keyword Recording function can search the First 250 channels listed on "All DVB Channels" or the First 50 channels registered for "Favourites1".

- When setting "First 50 Favourites1" as a search target, register the channels you want to search with Keyword Recording to the First 50 channels of "Favourites1" in advance. (⇒ 88, 91)

Detail Search Condition

Set the detailed search condition. Narrow down programmes with specified criteria to search for only the programme you want to record.

Programme Type

Select the programme type. If, for example, you select "Art/Culture", only the programmes related to arts and culture are searched.

Free Services Only Record

Select whether to limit the search to free programmes or to include pay-per-view programmes in the search.

Video Format

Select whether to include HD and/or SD programmes in the search.

Remove Duplicates

When there are multiple programmes with the same title, start time and length, only the programme closest to the top of the channel list will be recorded.

Recording Settings:

Recording Mode (Picture Quality)

Refer to step on page 35, "Recording TV programmes".

Subtitle

You can choose whether or not to record the subtitle at conversion.

[Only when item other than "DR(Original)" is selected in "Recording Mode (Picture Quality)"]

Signal Supported Recording

You can choose whether or not to use the Signal Supported Recording function. (⇒ 40)

To display the list of programmes found with the set keyword

Press the yellow button in "Keyword Recording" screen.

| SAT 18.10 | Schedule | Programme Name |
|-----------|------------|--------------------------|
| 2 ABC1 | 7:00-7:30 | Olympic opening ceremony |
| 23 ABC2 | 7:00-8:00 | Olympic opening ceremony |
| 22 ABC1 | 9:00-11:30 | Ⓞ Olympic Soccer |
| 2 ABC2/4 | 7:00-7:30 | Olympic Judo |
| 22 ABC1 | 9:00-10:30 | Olympic Boxing |

- Ⓞ Blue: Recording has already been set with a different Keyword.
- Ⓞ Red: Timer recording standby is activated.

Priority order of Keyword Recording

Recording takes place in the following order of priority:

- 1 A programme that is already being recorded
- 2 Timer Recording
- 3 Keyword Recording (programmes will be recorded in ascending order from keyword number 1 to 16)
- 4 A programme that starts first

Keyword Recording may not work in some cases. To avoid recording failure, we recommend using Timer Recording instead of Keyword Recording.

Changing the recording method

Select the programme marked "Ⓞ" (Blue), then press the red button on the Keyword Recording status screen or TV Guide screen. (⇒ left)



- Programmes set for timer recordings are not treated as Keyword Recording programmes.

Automatic deletion of Keyword Recording

By default, when the HDD capacity is low, the unit automatically deletes programmes recorded with Keyword Recording, starting from the one with the oldest recording date.

Perform the following not to delete them as necessary. (⇒ 50)

- Protect programmes.
- Change automatic delete settings.
- Remove programmes from "Keyword Record".
- Copy programmes before deleting them.

Keyword List operations

Display the Keyword List

You can also set keywords from FUNCTION MENU.

- 1 Press [FUNCTION MENU].
- 2 Select "Keyword Recording", then press [OK].

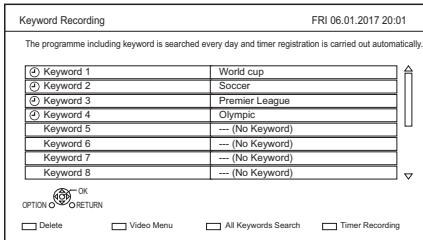

To add/edit the Keyword

Select the Keyword and press [OK], then make required settings.

- Refer to "Keyword Recording conditions" (⇒ 44)

To deactivate the Keyword Recording

- 1 Select the Keyword, then press [OPTION] button.
 - 2 Select "Turn Keyword Off", then press [OK].
- Select "Turn Keyword On" in step 2 to return to Keyword Recording standby mode.

To search programmes matched with any of the registered keywords

Press the yellow button.

To play programmes recorded with Keyword Recording

Press the green button.

- Refer to "Playing Keyword Recording programmes" (⇒ 50)

To delete the registered Keyword

- 1 Select the Keyword, then press the red button.
- 2 Select "Yes", then press [OK].

To change the recording priority of keywords

- Refer to "Priority order of Keyword Recording" (⇒ 44)

- 1 Press [OPTION].
- 2 Select "Change Priority", then press [OK].
- 3 Press [▲, ▼] to shift the position, then press [OK].

Using the external HDD (USB HDD)



* “For recorded programmes (⇒ 27)” only

If you intend to move recorded programmes to a USB HDD, the USB HDD must be registered to this unit first.

Limitation information

- Registering of a USB HDD will format the USB HDD and all the content already recorded will be deleted.
- Up to eight USB HDDs can be registered on this unit. If you have already registered eight USB HDDs, it will be necessary to delete one or more of them before registering a new USB HDD.
- Registered USB HDDs cannot be used with devices other than this unit.

Regarding the external HDD (USB HDD)

- Certain non-confirmed USB HDDs cannot be used with this unit.
- If a problem occurs with the USB HDD, please contact the manufacturer of the device.

Connecting the USB HDD

Connect this unit with optional USB HDD.

e.g., **UBC90**

This unit's rear panel

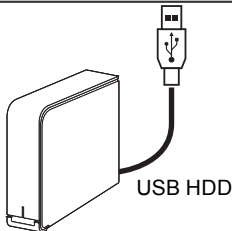
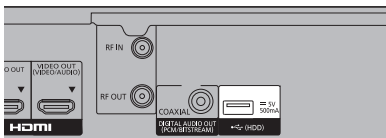

- Only one USB HDD (For recorded programmes, ⇒ 27) can be connected.
- The USB HDD can be connected to the USB port on the rear of this unit.

Registering the USB HDD

- If the registering screen appears when connecting the USB HDD, go to step 5.

- 1 Press [FUNCTION MENU].
- 2 Select “Basic Settings” in “Setup”, then press [OK].
- 3 Select “Settings for USB HDD” in “HDD / Disc / USB HDD”, then press [OK].
- 4 Select “USB HDD Registration”, then press [OK].
- 5 Select “Yes”, then press [OK].
- 6 When the registering is complete, message screen appears. Press [OK].
- 7 The confirmation screen appears. Press [OK].

To cancel all USB HDD registrations (⇒ 94)



- It is not possible to play back the content on the USB HDD whose registration has been cancelled.
- You can check the registration number of the USB HDD on the Video Menu. (⇒ 47)

Disconnecting the USB HDD

Disconnecting without following this procedure may result in the loss of recorded content from the USB HDD or the internal HDD.

- 1 Press [FUNCTION MENU].
- 2 Select “Basic Settings” in “Setup”, then press [OK].
- 3 Select “Settings for USB HDD” in “HDD / Disc / USB HDD”, then press [OK].
- 4 Select “USB HDD Disconnection”, then press [OK].
- 5 Select “Yes”, then press [OK].
- 6 Disconnect the USB HDD from this unit.

Playing programmes on the HDD



* "For recorded programmes (⇒ 27)" only

- 1** Press [FUNCTION MENU].
- 2** Select "Contents on HDD", then press [OK].

e.g.,



- 3** To play recorded programmes: Select "Recorded Programmes", then press [OK].
The Video Menu screen appears (⇒ right).

To play HD Video (AVCHD):
Select "Video (AVCHD)", then press [OK].

The AVCHD tab appears on the Video Menu screen (⇒ right).

To play video files:
Select "Video (MP4 / MKV)", then press [OK].

The video list screen appears (⇒ 51).

- 4** Select the programme, then press [OK].

Video Menu screen

e.g.,

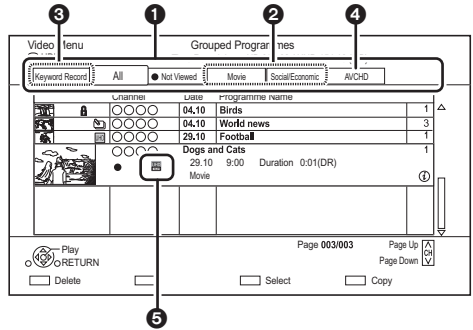

- 1** Tab (⇒ 49)
- 2** Programme type
- 3** Keyword Recording
Refer to "Playing Keyword Recording programmes" (⇒ 50)
- 4** AVCHD tab

- **[USB HDD]** When connecting registered USB HDD, "USB HDD" tab and registration number appears.
Select "USB HDD" tab.

e.g.,

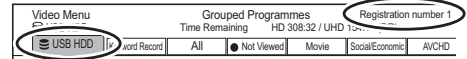

Playing back UHD (4K) programmes

This unit can play back UHD/HDR programmes recorded with it.

Programmes formatted in both UHD and HDR is indicated by an icon representing them, which is displayed in the location **5**.

Other screen icons (⇒ 48)

Screen icons

 (Red) Currently recording programme

 Protected programme



- Programme was not recorded due to recording protection
- Recording did not complete as the timer recording has started.

× Programme cannot be played. (When data is damaged etc.)



Programme is copy protected. (One generation copy is permitted)

Programme requires a CAM with a playback licence to play back.



- The number of times the programme can be played back may also be limited.

Programme cannot be played back when a certain time has elapsed after the recording.



- * The icon turns grey after the playback period has passed.
- Playback period limit can be checked in the information of that programme. (⇒ 49, Showing Information)



* Programme is copy restricted.

Programme requires a CAM with a playback licence to play back. If a certain time has elapsed after the recording, the programme cannot be played back.



- * The number of times the programme can be played back may also be limited.

- Encrypted programme
- Programme has failed to be decrypted.



- Press [STATUS ⓘ] to show the reason of the failure.



(Grey) Programme cannot be played back, edited (except deleting) or copied.

Delete the programme. (⇒ 60)



Grouped programmes



(Blue) Programme has not yet been played.



Programme is recorded using a different system from that of the unit. Change the "TV System" (⇒ 96).



Radio programme



UHD and HDR programme



UHD programme



HDR programme



3D contents



Recorded in 1080/50p contents



Recorded in 1080/60p contents

- Programme has a rating level set by the CAM.



- **[UBC90]** Programme is restricted by Child Lock List or Parental Rating (⇒ 90).



Keyword recording programme which has not yet been played



Grouped Keyword recording programmes



Keyword recording programme which has already been played



Notification icon for a new Keyword Recording

- * Programme cannot be edited (except deleting) or copied.

Tab

You can quickly find the recorded programmes by selecting the tab.

To select the tab

Press [◀, ▶].

To change the displayed programme type tab

- 1 Select the programme type, then press the green button.
- 2 Select the item, then press [OK].

Showing Information

Select the programme, then press [STATUS ⓘ].

Showing grouped programmes



- 1 Press [OPTION].
- 2 Select "Grouped Programmes" or "All Programmes", then press [OK].

Grouped Programmes:

- Two or more programmes recorded in the daily/weekly timer recording mode are bundled and displayed as one item.
- Two or more Keyword recording programmes recorded from the same Keyword.

All Programmes

Playing back grouped programmes

- 1 On the Grouped Programmes screen:
Select the item marked with  or .
- 2 **When playing all programmes:**
Press [▶ × 1.3].



- This function cannot be used if the group includes any encrypted programme (.

When playing the individual programme:

Press [OK] and select the programme, then press [OK].

Editing the grouped programmes

- 1 Select the programme or the group, then press the yellow button.
 - A check mark is displayed. Repeat this step.
 - Press the yellow button again to cancel.
- 2 Press [OPTION].
- 3 Select the item below, then press [OK].
 - Create Group:**
Selected programmes are bundled to form a group.
 - Release Grouping:**
All the programmes in the group are released.
 - Remove:**
Selected programmes are removed from the group.

Playback from Chapter View

- 1 Select the programme, then press [OPTION].
- 2 Select "Chapter View", then press [OK].
e.g., **HDD**

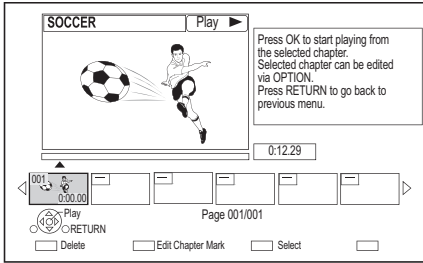

- 3 Select the chapter, then press [OK].

To edit the chapter in Chapter View

Refer to "Editing chapters". (⇒ 63)



- If the programme is recorded in the encrypted form, the chapter will be created only after the programme is decrypted.

Playing Keyword Recording programmes

- 1 Select "Keyword Record" tab.

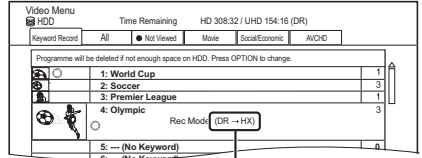

Recording mode (picture quality) to change (⇒ 36)

- 2 Select the Keyword, then Press [OK].
- 3 Select the programme, then press [OK].

To protect Keyword Recording programmes

- 1 Select the programme, then press the green button in step 3. (⇒ above)
- 2 Select "Set up Protection", then press [OK].

To delete Keyword Recording programmes

You can delete keywords and all programmes found with the keywords.

- 1 Press the red button in step 2. (⇒ above)
- 2 Select "Delete", then press [OK].

To remove Keyword Recording programmes from "Keyword Record"

Keyword Recording programmes removed from "Keyword Record" will be treated as normal programmes.

- 1 Select the programme, then press [OPTION] in step 3. (⇒ above)
- 2 Select "Remove from Keyword Record", then press [OK].
- 3 Select "Remove", then press [OK].

To copy Keyword Recording programmes

If you select keywords before copying, you can copy all the programmes containing the keywords.

- For information on copy operations, refer to "Copying programmes". (⇒ 64)

e.g.,

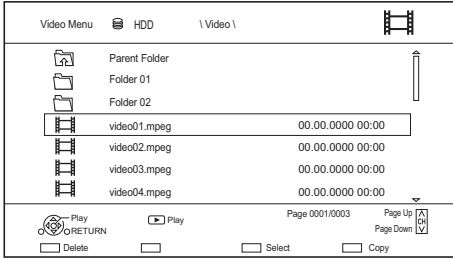

Screen icons

| | |
|--|----------------------------------|
| | Folder |
| | Video files |
| | Video files (4K) |
| | Copy to SD card is not available |
| | Move to the parent folder |



- When video playback has ended, the next video will be played back continuously if there is another video in the same folder.
- When the following conditions are met, videos are played back in 4K regardless of the image quality:
 - When this unit is connected to a TV that is 4K and 24p/25p compatible
 - When "Video Format" is set to "Automatic" (⇒ 96)
 - When "24p / 25p Conversion" is set to "Auto" (⇒ 59)
 This unit can not output 4K image when playing back in 3D.

Playing contents on the media



* "For data files (⇒ 27)" only

1 Insert the media.

- AVCHD: If the menu screen is not displayed
Press **[▶]** × 1.3].

2 When the Video Menu screen or menu screen etc., appears:

- **Select the item or content, then press [OK].**
- Repeat this step if necessary.

To play back the playlist created on other equipment

- 1 Press [FUNCTION MENU].
- 2 Select "Disc" in "Media", then press [OK].
- 3 Select "Playlists", then press [OK].
- 4 Select the playlist, then press [OK].



- When the following conditions are met, videos are played back in 4K regardless of the image quality:
 - When this unit is connected to a TV that is 4K and 24p/25p compatible
 - When "Video Format" is set to "Automatic" (⇒ 96)
 - When "24p / 25p Conversion" is set to "Auto" (⇒ 59)
 This unit can not output 4K image when playing back in 3D.
- To enjoy BD-Video that supports Dolby Atmos® or DTS:X™ (⇒ 95)

Menu screen

Selecting screen for each operation is displayed when the media is inserted, and you can access the operation screen easily.

e.g., **USB**

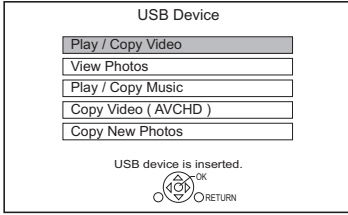

- Display items differ depending on what is recorded in each media.

If the menu screen is not displayed, display it by performing the following operation.

- 1 While stopped
Press [FUNCTION MENU].
- 2 Select "Media", then press [OK].
- 3 Select the media, then press [OK].

Video list screen

e.g., **USB**

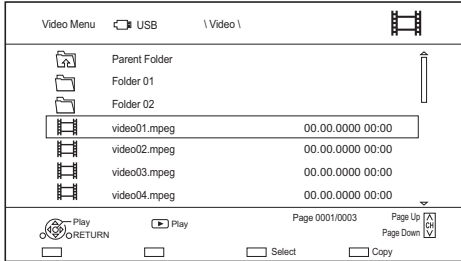

About screen icons (⇒ 51)

Video Menu screen

e.g., **BD-RE**

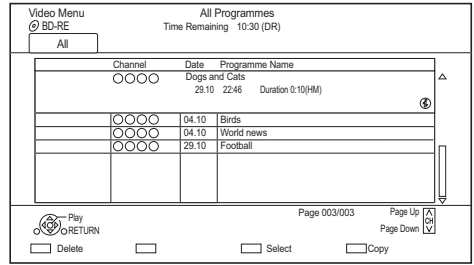

Showing Information

Select the programme, then press [STATUS ⓘ].

Playback from Chapter View (⇒ 50)

Notes for BD-Live discs

BD-V

BD-Live allows you to enjoy more functions such as subtitles, exclusive images and online games.

Preparation

- 1 Perform network connection and settings.
(⇒ 19, 22)
- 2 Insert a disc.

For the playback method, refer to the instructions for the disc.

Delete BD-Video data

If you no longer need BD-Live data recorded on the built-in HDD, you can delete data with the following operation.

- 1 Press [FUNCTION MENU].
- 2 Select "BD-Video Data Management" in "Setup", then press [OK].
- 3 Select "Delete BD-Video data", then press [OK].
- 4 Select "Yes", then press [OK].
- 5 Select "Start", then press [OK].
- 6 Press [OK].



- You can restrict Internet access when BD-Live functions are used (⇒ 92, BD-Live).
- When "Pure Sound mode" is set to "On", this unit cannot use BD-Live functions. (⇒ 93)

Operation during play

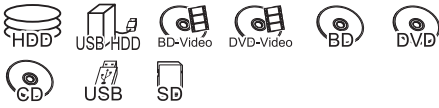

- Discs continue to rotate while menus are displayed. Press [■] when you have finished playback to protect the unit's motor, your TV screen, etc.

General operations

Status messages

Press [STATUS ⓘ].

- Each time you press [STATUS ⓘ], the display information may change or disappear from the screen.

e.g.,

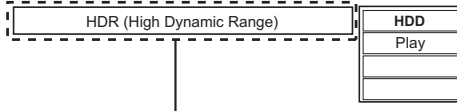

Displayed when an HDR video signal is being output.

e.g.,

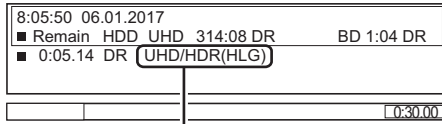

"HDR (HLG)" is indicated for HDR (HLG) programmes. ("HDR (PQ)" is indicated for HDR (PQ) programmes.)



- Depending on media and contents, the display may change or not appear.

Stop

Press [■].

Resume play function

Press [▶ × 1.3] to restart from the stopped position.



- **Discs:** Only previous stopped position is memorised. The position may be cleared if the tray is opened or the unit is switched to standby mode.

Quick View

Press and hold [▶ × 1.3].

- Press again to return to normal speed.



- **UHD programmes (4K), MKV, MP4 and MPEG2:** Quick View is not effective.
- Quick View is not effective when playing back the DVD-RW disc.
- Quick View may not work when recording in XP or FR mode.
- Quick View cannot be used on encrypted programmes (🔒).

Search

Press [◀◀] or [▶▶].

- Press [▶ × 1.3] to restart play.



- The speed increases up to 5 steps. (+R +RW: Up to 3 steps)
- **UHD programmes (4K), Ultra HD Blu-ray, MKV, MP4 and MPEG2:** Audio is not heard during all levels search.

Pause

Press [II].

- Press [▶] × 1.3] to restart play.

Slow-motion

While paused, press [◀◀] or [▶▶].

- Press [▶] × 1.3] to restart play.



- The speed increases up to 5 steps.
- **MKV, MP4 and MPEG2:** Slow-motion is not effective.
- **BD-V, AVCHD (DVD-R):** Forward direction [▶▶] only.
- Slow-motion cannot be used on encrypted programmes (🔒).

Frame-by-frame

While paused, press [◀] (◀◀) or [▶] (▶▶).

- Each press shows the next frame.
- Press and hold to change in succession forward or backward.
- Press [▶] × 1.3] to restart play.



- **MKV, MP4 and MPEG2:** Frame-by-frame is not effective.
- **BD-V, AVCHD (DVD-R):** Forward direction [▶] (▶▶) only.
- Frame-by-frame cannot be used on encrypted programmes (🔒).

Manual Skip

Skip forward 1 minute:

Press [+60s].

Skip backward 10 seconds:

Press [-10s].



- Depending on the content that you play back, this function is not available.

To display menu

BD-V | **DVD-V**

- 1 Press [OPTION].
- 2 Select "Playback Menu", then press [OK].
- 3 Select "Top Menu", "Pop-up Menu" or "Menu", then press [OK].

Skipping the content or chapter

Press [◀◀] or [▶▶].



- **HDD** | **USB HDD** (For recorded programmes, ⇨ 27): It will not skip the programme. But the programme in the grouped programmes will be skipped. (⇨ 49)
- [▶▶] is not effective for encrypted programmes (🔒).

Changing audio

Press [AUDIO].

- It will switch depending on the contents recorded every time it is pressed.

Listening to the Audio Description

HDD | **USB HDD** (For recorded programmes, ⇨ 27)

BD-RE | **BD-R**

- 1 Press [OPTION].
- 2 Select "Playback Settings" in "Playback Menu", then press [OK].
- 3 Select "Basic Operation", then press [OK].
- 4 Select "Audio Description", then press [OK].
- 5 Select "Audio Description" and set to "Automatic".
- 6 Select "Volume", then adjust the volume with [◀, ▶].



- Depending on the usage conditions of this unit, this function is not available.
- For details about the Audio Description, refer to "To listen to the Audio Description" (⇨ 32).

Switching subtitles

HDD **USB HDD** (For recorded programmes, ⇒ 27)

BD-RE **BD-R**

- 1 Press [STTL ].
 - 2 Press [OK].
 - 3 Select "On" or "Off", then press [OK].
- If you want to switch the subtitle language, select it in the Basic Operation menu (⇒ 58).

BD-V **DVD-V**, **MKV**:

Display with "Subtitle Settings" or "Subtitles" in the Basic Operation menu (⇒ 58).



- **MKV**: If the subtitles text are not displayed correctly, try changing the language settings (⇒ 92, Subtitle Text).

Displaying the Teletext

HDD **USB HDD** (For recorded programmes, ⇒ 27)

BD-RE **BD-R**

Press [TEXT ].



- Teletext display mode is TOP (FLOF) only.
- Some functions may not work.
- Teletext cannot be displayed when the subtitles are set to ON.

Enjoying Ultra HD Blu-ray

You can enjoy the playback of Ultra HD Blu-ray discs with this unit.

Preparation

- For 4K/HDR viewing, connect to a TV and terminals that support HDCP2.2^{*1}, 4K (50p/60p) 4:4:4 and HDR signals that meet Ultra HD Blu-ray standards. (⇒ 11)
- Network connection (⇒ 19)
- Network setting (⇒ 22)

Due to copyright restrictions, it may not be possible to play back certain discs unless this unit is connected to the Internet.



- When connected to a TV or terminal that does not support HDCP2.2^{*1}, this unit applies Dynamic Range Conversion^{*2} to HDR signals to output them in 2K resolution. In addition, depending on the disc, it may not be possible to perform playback correctly.
- When connected to a TV or terminal that supports 4K (50p/60p) 4:2:0 (8 bit) and lower, this unit plays back 50p/60p content by applying Dynamic Range Conversion^{*2} to its HDR signals to output them.
- When connected to a TV or terminal that does not support 4K resolution, this unit applies Dynamic Range Conversion^{*2} to HDR signals to output them in 2K resolution.
- When connected to a TV or terminal that does not support HDR, this unit applies Dynamic Range Conversion^{*2} to HDR signals to output them. In addition, depending on the disc, it may not be possible to output content in 2K resolution or perform playback correctly.

^{*1} HDCP is a technology designed to prevent illegal copying. "2.2" represents a version.

^{*2} Dynamic Range Conversion is a function that converts HDR video signals into video signals suited to TVs that do not support HDR input.

3D video playback

Preparation

Connect 3D compatible TV to this unit. (⇒ 12, 13)

- Perform the necessary preparations for the TV.

Play back following the instructions displayed on the screen.

Preparatory 3D settings

3D BD-Video Playback

It is also possible to play back 3D discs in 2D (conventional video). (⇒ 92)

3D AVCHD Output

If 2D AVCHD video is recognised as 3D video and cannot be played back correctly, you may be able to play it by changing the setting. (⇒ 96)

3D Playback Message

Hide the 3D viewing warning screen. (⇒ 96)

3D settings during playback

Change this setting when the screen is not correctly displayed for 3D compatible programmes.

- 1 Press [OPTION].
- 2 Select "Playback Settings" in "Playback Menu", then press [OK].
- 3 Select "3D Settings", then press [OK].
- 4 Select the item below, then press [OK].

Signal Format

- Original:

Keep original picture format.

- Side by side:

3D picture format comprising of left and right screens.

Graphic Display Level

Adjust the 3D position for the playback menu or message screen etc.



- Please refrain from viewing 3D images if you do not feel well or are experiencing visual fatigue.
In the event that you experience dizziness, nausea, or other discomfort while viewing 3D images, discontinue use and rest your eyes.
- Depending on the connected TV, the video being played back might switch to 2D video due to changes in resolution etc. Check the 3D setting on the TV.
- 3D video might not output the way it is set in "Video Format" (⇒ 96) and "24p Output" (⇒ 97).
- It may display as Side-by-Side (2 screen structure) when playback of the 3D video is started. Select "Side by side" in "Signal Format". (⇒ above)
- This unit only guarantees the playback of the Frame Sequential and the Side-by-Side (Half) programme types.

4K Networking

You can save 4K videos/photos recorded with digital cameras and other 4K-compatible devices to the HDD of this unit and play them back.

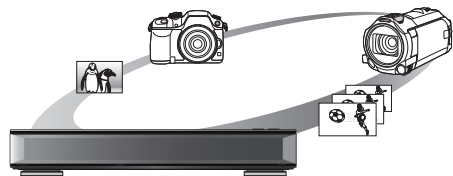

Compatible 4K content

- MP4, MKV and MPEG2 (TS) (4K/50p and 60p)
 - bit rate up to 100 Mbps
 - resolution up to 3840×2160 50p/60p, 4096×2160 50p/60p
- JPEG, MPO
 - resolution 3840×2160
 - Photos with a resolution greater than 3840×2160 are played back in 3840×2160.

Preparation

- Connect a 4K-compatible TV to this unit. (⇒ 11)

Playing back 4K content

■ 4K videos

HDD

Refer to “Playing programmes on the HDD”. (⇒ 47)

USB **SD**

Refer to “Playing contents on the media”. (⇒ 51)

■ Photos

Refer to “Playing photos”. (⇒ 71)



- Video may not be played back smoothly depending on the USB device.
- You can also watch the 4K contents stored in the DLNA Certified media server. (⇒ 78, Home Networking (DLNA))

Copying 4K content

■ 4K videos

HDD ↔ **SD**

USB → **HDD**

Refer to “Copying video files”. (⇒ 70)

■ Photos

Refer to “Selecting and copying the photos”. (⇒ 73)

Playback menu

A variety of playback operations and settings can be performed from this menu.

Available options differ depending on the playing contents and the condition of the unit.

- 1 Display the Playback menu.
 - 1 Press [OPTION].
 - 2 Select “Playback Settings” in “Playback Menu” or select “Playback Settings”, then press [OK].

e.g.,

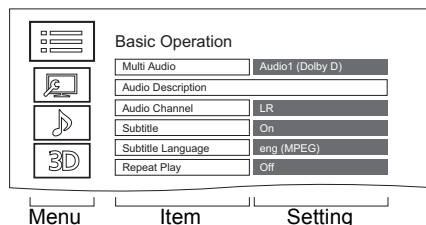

- 2 Select the menu, then press [OK].
- 3 Select the item, then press [OK].
- 4 Change the setting.

To clear the Playback menu

Press [RETURN ⊖] until the Playback menu disappears.

Display language list

| | | | | | |
|-----|------------|-----|------------|-----|------------|
| ENG | English | JPN | Japanese | ARA | Arabic |
| FRA | French | CHI | Chinese | HIN | Hindi |
| DEU | German | KOR | Korean | PER | Persian |
| ITA | Italian | MAL | Malay | IND | Indonesian |
| ESP | Spanish | VIE | Vietnamese | MRI | Maori |
| NLD | Dutch | THA | Thai | BUL | Bulgarian |
| SVE | Swedish | POL | Polish | RUM | Romanian |
| NOR | Norwegian | CES | Czech | GRE | Greek |
| DAN | Danish | SLK | Slovak | TUR | Turkish |
| POR | Portuguese | HUN | Hungarian | * | Others |
| RUS | Russian | FIN | Finnish | | |

Basic Operation

Soundtrack*

Show or change the soundtrack.

Multi Audio

Switch in the case of multiple audio.

Audio Description

Switch in the case of Audio Description.

Audio Channel

Change audio (LR/L/R) during playback.

Subtitles*

Subtitle Settings*

Turn the subtitle on/off, and change the language depending on the media.

Subtitles

Subtitle Style

Subtitle Position

Subtitle Luminance

Subtitle Language

Select the subtitle language in the case of multiple languages.

Angle*

Change the number to select an angle.

Repeat Play

Select the item which you want to repeat.

Shuffle

Select whether to play shuffle or not.

Video

The original video recording method (MPEG-4 AVC etc.) appears.

Primary Video

The original video recording method appears.

Secondary Video

Video

Select on/off of images.

The original video recording method appears.

Soundtrack

Select on/off of audio and the language.

Reception

The radio wave status during the playback of Home Networking (DLNA) is displayed. (Only when a wireless connection is used)

* With some discs, you may only be able to make changes using the menus on the disc.

Picture Settings

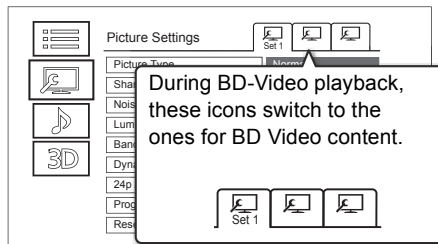

Switch "Set 1", "Set 2" or "Standard" by using [◀, ▶].

- You can register desired settings to "Set 1" and "Set 2". Settings for BD Video playback and settings for the playback of other types of media are registered separately. (The default settings for "Set 1"/ "Set 2" are the same as the settings for "Standard".)
- You cannot change the "Standard" settings.

Picture Type

Select the picture quality mode during play.

Sharpness Adjustment

Noise Reduction

Luminance/Colour Adjustment

Adjust the contrast, brightness, tone curve (white/black) colour saturation and hue.

Bandwidth Limitation

Adjusts the bandwidth limitations.

Dynamic Range Adjustment

Adjusts the brightness of the entire screen when HDR (High Dynamic Range) video is output.

Dynamic Range Conversion Adjustment

When this unit is connected to a TV that does not support HDR (High Dynamic Range) input, HDR video is output converting to a SDR (Standard Dynamic Range) video signal. If you set a smaller value, their contrast will be reproduced more faithfully, but the entire screen will appear darker. To increase the brightness, set a larger value.

24p / 25p Conversion

Plays back videos with film-like motion.

- This function is available on the following conditions:
 - "Video Format" set to "Automatic", "4K", "1080i"* or "1080p"* (⇒ 96)
 - * Only for 24p Conversion
 - Connect 24p/25p compatible TV.
- Noise may appear on the image when you switch the setting.

Progressive

Select the method of conversion for progressive output to suit the type of content being played.

- **Auto**
Automatically detects the film and video content, and appropriately converts it.
- **Video**
Select this setting when the content is distorted if "Auto" is selected.
- **Film**
Select this if the edges of the film content appear jagged or rough when "Auto" is selected. However, if the video content is distorted, then select "Auto".

Reset to Default Picture Settings

Restores the default settings of the Picture Settings menu.

Sound Settings

Sound Effects

- This function is effective when "Digital Audio Output" is set to "PCM". (⇒ 95)

Night Surround

Enjoy a movie with powerful sound even when the volume is kept low at night.

Remaster 1-3

Sound becomes more natural by adding higher frequency signals not recorded on the track.

Digital Tube Sound 1-6

This feature gives you a warm sound, like that produced by a vacuum tube amplifier.

Sound Effects Frequency

Set the maximum sampling frequency for the audio selected in "Sound Effects".

DSD Decode Sampling Frequency

Select the settings that suit your sound quality preferences.

DSD LPF Setting

Select the settings that suit your sound quality preferences.

Dialogue Enhancer

The volume of the centre channel is raised to make dialogue easier to hear.

High Clarity Sound

Stop processing signals that affect the audio quality or turn off the front panel display to make the audio quality clearer.

Select whether or not to output images.

This setting is able to switch by pressing the colour button (green/yellow) during playing music.

3D Settings (⇒ 56)

Signal Format

Graphic Display Level



- The menu is not displayed when playing photos.

Deleting/Editing programmes

Once deleted, divided or partially deleted, content cannot be restored to its original state. Make certain before proceeding.



* "For recorded programmes (⇒ 27)" only



If the disc is protected, release the protection. (⇒ 85, Disc Protection)

UBC90

PIN is required to edit the programmes with **R** in some functions. (⇒ 48)

Deleting recorded programmes

- On the Video Menu screen:
Select the programme.

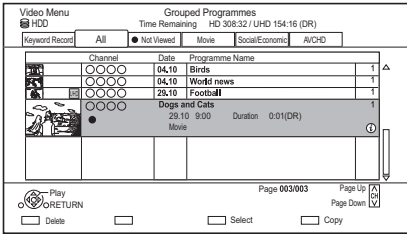

- Press the red button.
- Select "Delete", then press [OK].

Multiple selection

Select the programme, then press the yellow button. A check mark is displayed. Repeat this step.

- Press the yellow button again to cancel.



Available disc space after deleting:

- **HDD** **USB HDD** **BD-RE** **RAM**

The space deleted becomes available for recording.

- **BD-R** **DVD-R** **+R**

Available space does not increase even after the contents are deleted.

- **DVD-RW** **+RW**

Available recording space increases only when the last recorded programme is deleted.

Editing recorded programmes

- If the programme is contents protected, you may not perform editing other than deleting. (⇒ 10)

- On the Video Menu screen:
Select the programme.
• Multiple selection (⇒ left)
- Press [OPTION].
- Select the item, then press [OK].
e.g.,

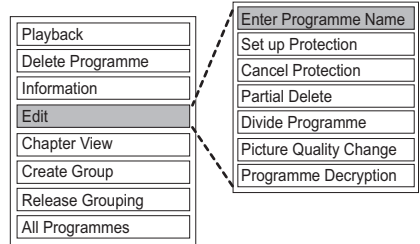

Entering programme name

- Select "Enter Programme Name" in "Edit", then press [OK].
- Refer to "Entering text". (⇒ 87)

Setting protection

HDD **USB HDD** **BD-RE** **BD-R** **RAM** **+R** **+RW**

Protection setting prevents the programme from accidental deletion.

- Select "Set up Protection" or "Cancel Protection" in "Edit", then press [OK].
- Select "Yes", then press [OK].

A appears when setting the protection.



This function cannot be used on encrypted programmes



Partial deleting

HDD **USB HDD** **BD-RE** **BD-R** **RAM**

- 1 Select "Partial Delete" in "Edit", then press [OK].
- 2 Press [OK] at the start point and end point to delete.
 - You can find the desired point by using play, search, etc. (⇒ 53)
- 3 Select "Continue", then press [OK].
 - Select "Next", then press [OK] to delete other sections. Up to 20 sections can be set. (⇒ go to step 2)
- 4 Select "Delete", then press [OK].
- 5 Press [RETURN ⊕].



- This function cannot be used on encrypted programmes (🔒).
- Chapter Mark is generated in the scene that was partially deleted.

Dividing programme

HDD **USB HDD** **BD-RE** **BD-R** **RAM**

- 1 Select "Divide Programme" in "Edit", then press [OK].
- 2 Press [OK] at the point to divide the programme.
 - You can find the desired point by using play, search, etc. (⇒ 53)
- 3 Select "Continue", then press [OK].
- 4 Select "Divide", then press [OK].

To confirm the division point

After performing step 2.

Select "Preview", then press [OK].

- The unit plays 10 seconds before and after the division point.

To change the division point

After performing step 2.

Restart play and select "Divide", then press [OK] at the division point.



- **HDD** **USB HDD** Divided programmes will become a group of programmes.
- This function cannot be used on encrypted programmes (🔒).

Picture Quality Change

HDD **USB HDD**

The Picture Quality Change function changes the recording mode of programmes in DR mode or AVCHD format. Programmes will be smaller in size after their recording mode is changed. It takes about the same amount of time as recording to change the mode.

- 1 On the Video Menu screen (⇒ 60):
Select the programme in DR mode or the AVCHD content.
 - Multiple selection (⇒ 60)
- 2 Press [OPTION].
- 3 Select "Picture Quality Change" in "Edit", then press [OK].
e.g.,

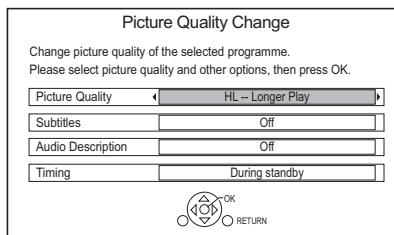

- 4 Set the picture quality change options, then press [OK].

Picture Quality (⇒ 27):

- **USB HDD** You cannot select XP, SP and LP mode.

Subtitles:

• Automatic

Subtitles will be recorded if they are included in the programme.

• Off

Subtitle will not be recorded.

Audio Description:

• Automatic

Audio Description will be recorded if they are included in the programme.

• Off

Audio Description will not be recorded.

Timing:

• Now

A picture quality change starts immediately after step 6.

- Time recordings cannot be made while a picture quality change is in progress.

- If an encrypted programme (🔒) is included, “Now” cannot be selected.

• During standby

A picture quality change starts after the unit is switched to standby mode.

5 Select the item below, then press [OK].

Delete:

The original programme will be deleted to save the storage capacity of the HDD after the picture quality is changed.

Keep:

The original programme is retained even after the picture quality is changed.

- The original programme will be deleted after Picture Quality Change, if the selected

programme is indicated with . (⇒ 10)

6 If you have selected “Now”:

Select “Start”, then press [OK].

If you have selected “During standby”:

Press [OK].

- Picture quality change will be performed after the unit is switched to standby mode.

“COPY” or “CONVERSION” on the front panel display stay lit while a picture quality change is in progress.

- The picture quality of encrypted programmes (🔒) will be changed after they are decrypted.

To cancel a picture quality change if you selected “Now”

Press and hold [RETURN ⏪] for more than 3 seconds.

To cancel a picture quality change if you selected “During standby”

After performing steps 1–2 (⇒ 60, Editing recorded programmes)

- 1 Select “Picture Quality Change” in “Edit”, then press [OK].
- 2 Select “Yes”, then press [OK].

To check to see if a picture quality change is finished

Press [VIDEO MENU].

e.g.,

| Channel | Date | Programme Name | |
|---------|------------|----------------|---|
| ○○○○ | 04.10 | Birds | 1 |
| ○○○○ | 04.10 | World news | 1 |
| ○○○○ | 29.10 | Football | 1 |
| ○○○○ | | Dogs and Cats | 1 |
| | 29.10 9:00 | Movie | |

Duration: 0:01(DR→HL)

When “○○ → ○○” (Picture quality change display) is displayed, the process has not finished yet.



- To use “Picture Quality Change”, the HDD needs enough storage capacity.
- Teletext will not be recorded.
- If “During standby” is set for the Picture Quality Change function, the change being applied stops when this unit is turned on. The process will start from the beginning again once the unit is switched to standby mode.
- When the picture quality is changed, 3D information may be lost.
- When the picture quality of a programme is changed, its new audio and subtitle language settings will be determined by the following settings:
 - “Multi Audio” and “Subtitles” in “Preferred Language” (⇒ 90, 92)

Programme Decryption

HDD

Encrypted programmes (🔒) can be decrypted manually.

- 1 Select “Programme Decryption” in “Edit”, then press [OK].
- 2 Select whether to delete the original programme or not, then press [OK].
 - **Yes**

The original programme will be deleted to save HDD capacity after decryption.
 - **No**

The original programme remains after decryption.
- 3 Select “Start”, then press [OK]. Decryption starts.

“Decrypting” appears during decryption.

 - When a programme that is copy protected (One generation copy is permitted) is selected, the original programme will be deleted after decryption. (⇒ 10)

To cancel the decryption

Press and hold [RETURN ⊞] for more than 3 seconds.



- For decryption, the CI module that supports the programme is necessary.
- During decryption, do not remove the CI module from this unit. (⇒ 9)
- Depending on the programme, playback/decryption may not be possible.

Editing chapters

HDD **USB HDD** **BD-RE** **BD-R** **RAM**

- 1 Select "Chapter View", then press [OK].
- 2 Perform the editing operations.

Edit Chapter Mark:

Select the point where you want to start a new chapter while viewing the programme.

- 1 Press the green button.
- 2 Press [OK] at the point you want to divide.
 - Repeat this step.
- 3 Press [RETURN ⊞] to go to Chapter View screen.

To delete the chapter:

- 1 Select the chapter, then press the red button.
 - Multiple selection (⇒ 60)
- 2 Select "Delete", then press [OK].

To combine chapters (Delete chapter mark):

- 1 Select the chapter, then press [OPTION].
- 2 Select "Combine Chapters", then press [OK].
- 3 Select "Combine", then press [OK].

The selected chapter is combined to the next chapter.

Playback from Chapter View

Refer to "Playback from Chapter View". (⇒ 50)



- The maximum number of chapters:
(Depends on the state of recording.)
 - HDD** **USB HDD**: Approx. 1000 per programme
 - BD-RE** **BD-R** **RAM**: Approx. 1000 per disc
- **HDD** **USB HDD** When the programme has the maximum number of chapters, you cannot perform the Resume play function (⇒ 53) with the programme.
- This function cannot be used on encrypted programmes (🔒).

Deleting video files on the HDD

- 1 On the video list screen:
Select the file or folder.

e.g.,

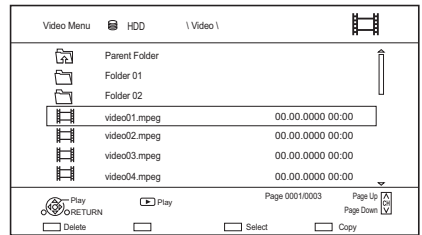

- Multiple selection (⇒ 60)
- 2 Press the red button.
- 3 Select "Yes", then press [OK].



- All files in the folder will be deleted.

Copying programmes

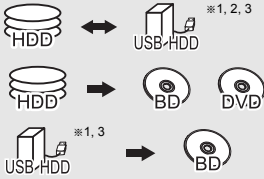

- ※1 “For recorded programmes (⇒ 27)” only
- ※2 The programme in the source media will be deleted.
- ※3 The recording mode (picture quality) cannot be changed.

- 1 Insert or connect the media.**
- 2 Press [FUNCTION MENU].**
- 3 Select “Recorded Programmes” or “Video (AVCHD)” in “Contents on HDD”, then press [OK].**
- 4 Select the programme.**
 - **Multiple selection**
Select the programme, then press the yellow button.
A check mark is displayed. Repeat this step.
 - Press the yellow button again to cancel.
- 5 Press the blue button.**
The copy direction selection screen is displayed.
Select the copying direction, then press [OK].
- 6 Select “Yes”, then press [OK].**
 - If you select “No”, you can change the selection. (⇒ right, To change the selection)
- 7 Set other settings, then press [OK].**
(⇒ 65, Setting the copying options)
- 8 Select “Yes”, then press [OK].**



- Encrypted programmes () cannot be copied. (⇒ 37)
- Simultaneous operation is not possible while copying with finalising or creating Top Menu.
- You cannot copy the following programmes.
 - [USB HDD] Protected programmes
 - [USB HDD] HD Video (AVCHD)
- If you wish to choose the audio language, select the language from “Multi Audio” of “Preferred Language” before copying (⇒ 90, 92).

To register the external HDD (USB HDD) (⇒ 46)

To copy HD Video (AVCHD) to the DVD-R in High Definition (⇒ 70)

To copy video files (⇒ 70)

To release the disc protection (⇒ 85)

Copying UHD programmes (4K)

UHD programmes (4K) recorded with this unit can be copied to a USB HDD or disc.

- The programmes can be copied to a USB HDD in their original picture quality.
- It is necessary to change the picture quality to 2K to copy the programmes to a disc.



- The unit is provided with a function that performs up-conversion to 4K. It allows you to play back programmes that were changed to 2K in 4K picture quality if the unit is connected to a 4K TV.

To change the selection

- 1 Select “No”, then press [OK] in step 6 (⇒ left).**
e.g., [HDD] → [BD-RE]

The order of copying

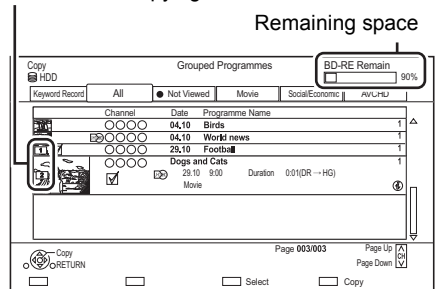

- 2 To change the selected programmes:**
Select the programme, then press the yellow button.

Repeat this step to select programmes.

To change the picture quality:

HDD → **BD-RE** **BD-R** **RAM** **DVD-R** **DVD-RW**
+R **+RW**

- 1 Select the programme, then press [OPTION].
 - 2 Select "Picture Quality Change", then press [OK].
 - 3 Select the picture quality, then press [OK].
Repeat steps if necessary.
- 3** Press the blue button.
- 4** Go to step 6. (⇒ 64)

About screen icons on the Video Menu

Refer to "Screen icons". (⇒ 67)

Setting the copying options

- 1 Select the item in step 7 (⇒ 64).
e.g.,

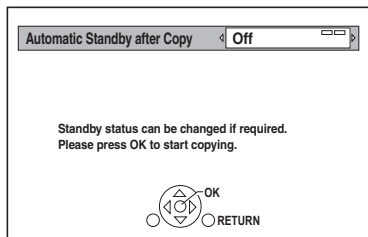

- 2 Press [◀, ▶] to change the settings.

• Automatic Standby after Copy On:

This unit is turned to standby mode when it is not operated for approximately 5 minutes after completing copy.

• Subtitles

Automatic:

Subtitles will be recorded if they are included in the programme.



- If you wish to choose the subtitle, select the language from "Subtitles" of "Preferred Language" before copying (⇒ 90, 92).

• Audio Description

Automatic:

Audio Description will be recorded if they are included in the programme.

• Finalise

On:

DVD-R **DVD-RW** **+R** The discs become play-only and you can also play them on other DVD equipment.

• Create Top Menu

On:

+RW You can play the disc on other DVD equipment.



- You can perform "Finalise" or "Create Top Menu" later. (⇒ 86, 87)

Copying from media other than HDD with Video Menu

BD-RE **BD-R** **RAM** **+RW** → **HDD**

- 1 Insert a disc.
The menu screen appears. (⇒ 52)
- 2 Select "Play Video", then press [OK].
- 3 Select the programme.
• Multiple selection (⇒ 64)
- 4 Press the blue button.

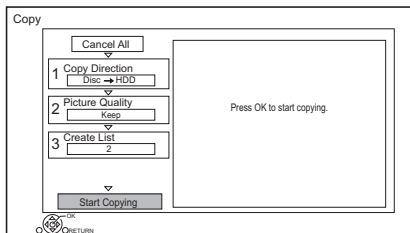

- To change the detailed settings for copy, refer to "Copying programmes with copying list". (⇒ 66)
- 5 Select "Start Copying", then press [OK].
 - 6 Select "Yes", then press [OK].

Copying programmes with copying list

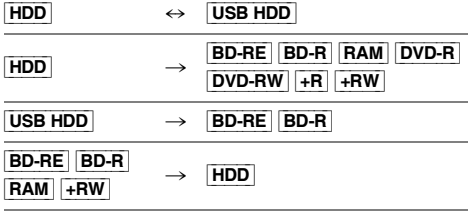

1 HDD ↔ USB HDD:

- 1 Press [FUNCTION MENU].
- 2 Select "Copy Menu" in "Copy Video", then press [OK].

Except "HDD ↔ USB HDD":

- 1 Insert a disc.
The menu screen appears. (⇒ 52)
- 2 Select "Copy", then press [OK].

2 Set the copy direction.

- 1 Select "Copy Direction", then press [▶] (right).
- 2 Set "Source" and "Destination".
- 3 Press [◀].

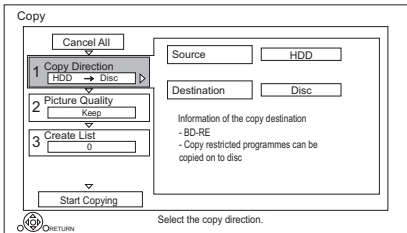

3 Set the picture quality (⇒ 27).

- 1 Select "Picture Quality", then press [▶] (right).
- 2 Set "Picture Quality".
- 3 Press [◀].



- Even if you copy HEVC programmes to a BD-RE/BD-R using Copy (Keep Picture Quality), the copied programmes may not be played back on other devices.

4 Register programmes for copy.

- 1 Select "Create List", then press [▶] (right).
 - 2 Select "New item", then press [OK].
 - 3 Select the programme, then press the yellow button.
- Repeat this step to select programmes.
e.g., **HDD**

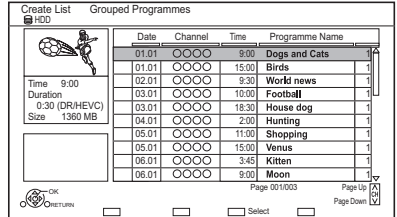

• To change the appearance of the list or show information of the programme

- 1 Press [OPTION].
- 2 Select the item, then press [OK].



- The programmes will be copied in the order of the copying list. If you want to specify the order, edit the copying list after the programmes are selected. (⇒ 67, Editing the copying list)

4 Press [OK].

5 Press [◀].

Data size of each registered programme

| No. | Size | Programme |
|----------|---------|-----------|
| New Item | Total=0 | |

Data size recorded to the copy destination

5 Make other settings.

- 1 Select "Other Settings", then press [▶] (right).

e.g.,

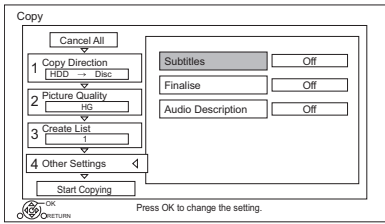

- This screen does not appear depending on the copying mode. (⇒ go to step 6)
- 2 Select the copying option, then press [OK].
(⇒ 65, Setting the copying options)
 - 3 Select the item, then press [OK].
 - 4 Press [◀].

6 Select "Start Copying", then press [OK].

7 Select "Yes", then press [OK].

To cancel all registered copying settings and lists

After performing step 1

- 1 Select "Cancel All", then press [OK].
- 2 Select "Yes", then press [OK].



- Encrypted programmes (🔒) cannot be copied. (⇒ 37)
- Programmes in the grouped programmes and other programmes cannot be registered simultaneously.
- **RAM** Radio programme cannot copy.

Editing the copying list

- 1 Select the programme after step 4-4 (⇒ 66).

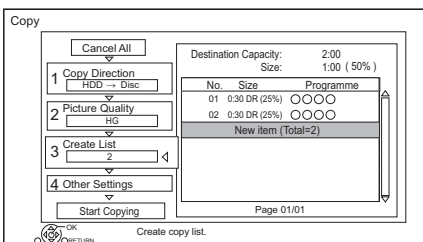

- 2 Press [OPTION].

- 3 Select the item below, then press [OK].

Delete All:

All programmes that you registered to copy are deleted.

Add:

Add new items to the copying list.

- 1 Select the programmes with the yellow button.
- 2 Press [OK].

Delete:

Selected programmes are deleted.

- Select the programme, then press the yellow button before step 2.

Repeat this step to select programmes.

Move:

Change the order of items on the copying list.

- Select the programme to move before step 2.

Select the destination, then press [OK].

Screen icons



UHD programmes that will be converted to HD picture quality before being copied



Programmes that can be copied to discs using Copy (Change Picture Quality)*.



Programmes that can be copied to the HDD using Copy (Change Picture Quality)*.



Programmes that cannot be copied to disc



Programmes that cannot be copied to HDD



Programme recorded using a different encoding system from that of the unit.



- Programmes displaying these marks cannot be selected.

- * The amount of time needed for a picture quality change is the same as the length of the programme to be copied.

About other screen icons (⇒ 48)

Copy (Keep Picture Quality)

The unit copies a programme while maintaining its original picture quality and recording time. This method can perform copying faster than Copy (Change Picture Quality) can.

- Copy (Keep Picture Quality) is available for the picture quality and media combinations below.

| Original programme's picture quality | Media |
|--------------------------------------|-----------------------|
| DR HG HX HE HL HM | |
| XP SP LP FR | <p>* DVD-RAM only</p> |

- Copy (Keep Picture Quality) can be used only when there is enough recording capacity on the destination media.



- Copy (Keep Picture Quality) is not available in the following cases:

- **HDD** → **BD-RE** **BD-R** :
 - Copying original radio programmes
- **HDD** → **DVD-R** **DVD-RW** **+R** **+RW** :
 - Programmes that contain many deleted segments
- **HDD** → **+R** **+RW** :
 - Programmes recorded in "FR" mode (with a recording time of 5 hours or longer) or "EP" mode*
 - Programmes recorded in 16:9 aspect

* Programmes recorded with another device in "EP" mode and imported from an external media to the HDD of this unit

Copy (Change Picture Quality)

The unit changes the picture quality of a programme while copying it. Copying will take about the same amount of time as the actual recording time.

- **DVD-R** **DVD-RW** **+R** **+RW** You cannot copy to the disc in the following cases.
 - When there is not enough free space on the HDD.
 - When the number of programmes recorded on the disc will exceed its maximum limit if copying is performed. (⇒ 26)
- Copying will continue up to the point cancelled.
 - **DVD-R** **DVD-RW** **+R** **+RW** If copy is cancelled during the step while temporarily copying to the HDD, then nothing will be copied.
 - **BD-R** **DVD-R** **DVD-RW** **+R** **+RW** Even if the programme was not copied to the disc, the amount of remaining writable disc space becomes less.
- When copying programme recorded in 1080/50p or 1080/60p, it cannot copy in progressive.

Copying 3D programmes

- It may not display correctly in 3D when a copied 3D programme is played back. In such a case, change the "Signal Format" during the playback of the programme. (⇒ 56)
- 3D information may not be copied.
- If you want to copy 3D AVCHD video to the disc in 3D, use BD-R or BD-RE and must use Copy (Keep Picture Quality).

About maintaining the chapter mark

- The position of the chapter might shift slightly.
- Maximum number of chapters on the disc is limited.
 - **BD-RE** **BD-R** **RAM** **DVD-R** **DVD-RW** : Approx. 1000
 - **+R** **+RW** : Approx. 254 (Depends on the state of recording.)

Copying a finalised disc

DVD-V → HDD

While playing a disc, the content being played is copied to the HDD according to the set time.

- 1 Press [FUNCTION MENU].
- 2 Select "Copy Menu" in "Copy Video", then press [OK].
- 3 Set "Picture Quality".
 - 1 Select "Picture Quality", then press [▶] (right).
 - 2 Press [OK], then select the picture quality (XP/SP/LP).
 - 3 Press [◀].
- 4 Set "Copy Time".
 - 1 Select "Copy Time", then press [▶] (right).
 - 2 Select "Time Setting", then press [OK].
 - 3 Select "On" or "Off".

On:

Set the copying time.

- Set a few minutes longer than the source title, in order to include the operation time before play begins.

Off:

Copying all the content on the disc.

- 4 Press [◀].
- 5 Select "Start Copying", then press [OK].
- 6 Select "Yes", then press [OK].
 - When the Top Menu is displayed: Select the title you want to start copying, then press [OK].



After the last title on the disc has finished playing the Top Menu is recorded until the set time is reached.

To stop copying

Press [■].

- If stopped partway, copying will be up to that point.



- Operations and on-screen displays during copy are also recorded.

Copying Programme Playing

HDD → BD-RE BD-R RAM DVD-R DVD-RW +R +RW

- 1 Play back the programme to copy.
 - Multiple audio, subtitle and Teletext displayed during playback will be copied.
 - Select the multiple audio with "Multi Audio" in the Basic Operation menu (⇒ 58)
 - Select the subtitles with "Subtitle Language" in the Basic Operation menu. (⇒ 58)
- 2 Press [OPTION].
- 3 Select "Copy Programme Playing", then press [OK].
- 4 Select "Start", then press [OK].

Copying will start from the beginning of the programme regardless of the playing position.

To stop copying

Press and hold [RETURN ⊕] for 3 seconds.



- Encrypted programmes (Ⓜ) cannot be copied.
- You can record to or play the HDD while Copy (Keep Picture Quality) is in progress. Press [OK] to exit the screen display.
- Press [STATUS ⓘ] to confirm the current progress.

• About picture quality and copying

Copy (Keep Picture Quality) is available if certain conditions are met. Refer to "Notes for copying". (⇒ 68)



- **BD-RE BD-R** When copying the programmes in DR, HG, HX, HE, HL or HM modes and the copy destination does not have enough space, one from HG, HX, HE, HL or HM modes will be selected to match the available space.
- **RAM DVD-R DVD-RW +R +RW** When copying a programme in DR, HG, HX, HE, HL or HM mode, Copy (Change Picture Quality) will be performed in FR mode.
- When copying a programme in XP, SP, LP or FR mode to a destination with not enough space, Copy (Change Picture Quality) will be performed in FR mode.

Copying HD Video (AVCHD) to the DVD-R in High Definition

You can copy HD Video (AVCHD) recorded on HDD to a DVD-R in High Definition quality.

HDD → **DVD-R**

- 1 Insert an unformatted DVD-R or DVD-R DL. The menu screen appears. (⇒ 52)
- 2 Select “Copy Video (AVCHD) to Disc”, then press [OK].
- 3 Go to step 4 on page 66, “Copying programmes with copying list”.

To copy HD Video (AVCHD) from other equipment

Refer to “Copying the HD Video (AVCHD)”. (⇒ 82)



- When a disc is named, formatting will be automatically performed. Therefore, do not name a disc before this operation. (⇒ 85, Disc Name)
- Discs will be automatically finalised after copy.
- The following HD Videos (AVCHD) cannot be copied to the disc in high definition.
 - Exceeding 18 Mbps
 - 1080/50p or 1080/60p
 - Without the AVCHD information (video recorded with certain non-Panasonic equipment, video copied to the HDD after copying it to BD-R or BD-RE once, etc.)
- 3D video may not be copied correctly.

Copying video files

HDD ↔ **SD**

USB → **HDD**

- 1 On the video list screen:
Select the file or folder.

e.g.,

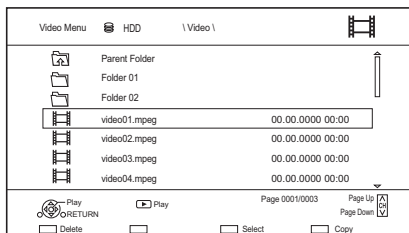

- Multiple selection (⇒ 64)
- 2 Press the blue button.
 - 3 Select “Yes”, then press [OK].

To stop copying

Press and hold [RETURN ⊕] for 3 seconds.

About screen icons

Refer to “Screen icons”. (⇒ 51)



- All files in the folder will be copied.
- The names of folders/files cannot be changed after they are copied to the HDD. We recommend that you create a folder with an easily identifiable name on a PC or other device first and use the folder to perform copying.
- Up to 1000 files can be copied at once.
- While copying, no other operations can be performed. Timer recordings will not proceed.
- **MKV**: Copying from the HDD to the SD card is not possible.

Photo



*1 "For data files (⇒ 27)" only (JPEG, MPO)

*2 **RAM** **DVD-R** **+R** only

Playing photos

- 1** **HDD**:
 - 1 Press [FUNCTION MENU].
 - 2 Select "Photo" in "Contents on HDD", then press [OK].Except **HDD**:
 - 1 Insert or connect the media.
The menu screen appears. (⇒ 52)
 - 2 Select "View Photos", then press [OK].
- 2** Select the folder, then press [OK].
 - Photo menu screen appears. (⇒ 72)
- 3** Select the photo, then press [OK].
 - Press [◀, ▶] to display the previous or next photo.



- When the following conditions are met, photos are played back in 4K regardless of the image quality:
 - When this unit is connected to a TV that is 4K and 30p compatible
 - When "Video Format" is set to "Automatic" (⇒ 96)This unit can not output 4K image when playing back in 3D.

Photo play option

- 1** While displaying a photo:
Press [OPTION].
- 2** Select the item below, then press [OK].

Graphic Display Level

You can change the 3D position of the screen display, etc., during the 3D photo playback.

Photo Menu

- **Start Slideshow**
You can start a slideshow.
- **Rotate RIGHT/Rotate LEFT**
 - The information of the rotated photos will not be stored depending on the media.
 - This function is not available during the 3D photo playback.
- **Information**
Information (shooting date etc.) is shown.
- **Wallpaper**
A photo being played back is registered as wallpaper on the FUNCTION MENU screen. (⇒ 29)

Photo Menu screen

e.g., **HDD**

Tab

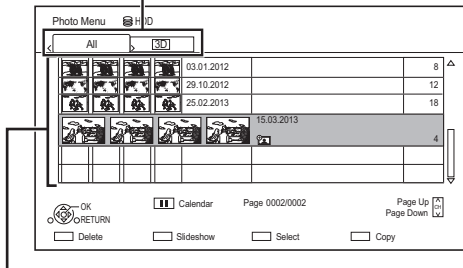

Photos imported to the HDD (⇒ 73) are managed using folders.

Folders and photos can be edited by pressing [OPTION]. (⇒ 73)

To select the tab

Press [◀, ▶].

To start Slideshow

Refer to "Slideshow settings". (⇒ right)

HDD

To display or exit the Calendar screen

Press [■].

Screen icons

3D 3D photos (MPO)
(Tab) • Select from this tab to play back in 3D.



Photo protected



New photo which is not viewed

Slideshow settings

- 1 On the Photo Menu screen:
Press the green button.

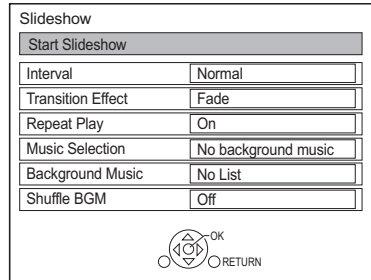

- 2 Select the item below, then press [OK].
Start Slideshow

Interval

Set up the time until the next photo is to display.

Transition Effect*

Effect for the next photo to display can be set.

Repeat Play

Music Selection*

Select background music on (either from HDD or USB) or off.

Background Music*

Select background music from HDD or USB (Folder).

Shuffle BGM*

Play back the BGM (Background Music) in shuffle order.

* This function is not available during the 3D photo playback.

To pause the Slideshow

Press [■].

- Press [■] again to restart.

To stop the Slideshow

Press [RETURN ⊙].

HDD BD-RE BD-R RAM SD

1 On the Photo Menu screen:

To edit the folder:

Select the folder.

To edit the photo:

- 1 Select the folder, then press [OK].
- 2 Select the photo to edit.

• **To select multiple folders or photos**
Press the yellow button when selecting the folder or photo.

A check mark is displayed. Repeat this step.

- Press the yellow button again to cancel.

2 Press [OPTION].

• Selectable items will change depending on the media and the type of file.

3 Select the item below, then press [OK].

Enter Folder Name

Refer to "Entering text". (⇒ 87)

Combine Folders

HDD

Delete Folder

Move Photos

HDD

Select "Move to new folder" or "Move to another folder", then press [OK].

- If "Move to another folder" is selected, set a destination folder.

Delete Photos

Set up Protection

BD-RE BD-R RAM SD

 appears.

- Even if the protection is set, the photo may be deleted by another unit.

Cancel Protection

BD-RE BD-R RAM SD

HDD

BD-RE BD-R
RAM SD

BD-RE BD-R RAM
DVD-R +R CD

HDD SD

USB HDD SD USB

HDD BD-RE BD-R
RAM

1 On the Photo Menu screen:

To copy the folder:

Select the folder, then press the blue button.

To copy the photo:

- 1 Select the folder, then press [OK].
- 2 Select the photos to copy, then press the blue button.

• **To select multiple folders or photos**
Press the yellow button when selecting the folder or photo.

A check mark is displayed. Repeat this step.

- Press the yellow button again to cancel.

2 Select the copying destination, then press [OK].

3 Select "Yes", then press [OK].
Copying will start.

To stop copying

Press and hold [RETURN ⊕] for 3 seconds.



- The name of the copied photos will be changed.

Copying automatically



Newly added photos will automatically be copied to the HDD.

- 1 Insert the media.
The menu screen appears. (⇒ 52)
- 2 Select “Copy New Photos”, then press [OK].
e.g., **USB**

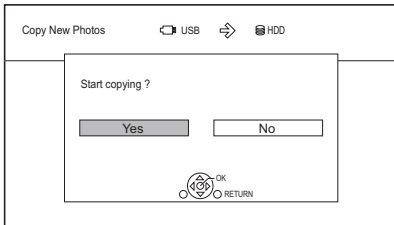

- 3 Select “Yes”, then press [OK].
Copying will start.
- 4 Once the copy is completed, select “Yes” or “No”, then press [OK].

To stop copying

Press and hold [RETURN ⊕] for 3 seconds.



- Photos without shooting date will be categorised using the creation date.
- The name of the copied photos will be changed.

Music



※1 “For data files (⇒ 27)” only

※2 **DVD-R** **+R** only

Playing music CD (CD-DA)

CD (CD-DA)

Insert the disc.

Playback will automatically start.

e.g.,

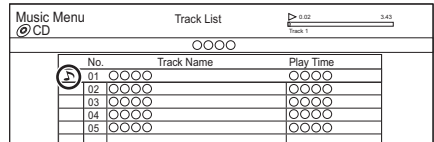

To play other music (track)

Select the item, then press [OK].

Playing music file on the media



- 1 Insert or connect the media.
The menu screen appears. (⇒ 52)
- 2 Select “Play / Copy Music”, then press [OK].
The music list screen appears.

e.g.,

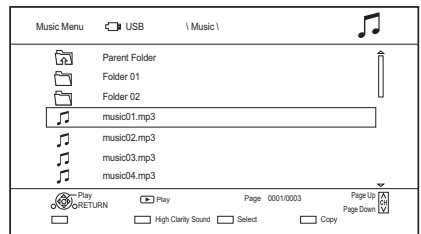

- 3 Select the item, then press [OK].
 - Repeat this step if necessary.
 Playback will start.



- The track/artist/album name will be displayed if the information is contained in music file.

Screen icons



Folder



Music



Move to the parent folder

Playing music file on the HDD

- 1 Press [FUNCTION MENU].
- 2 Select "Music" in "Contents on HDD", then press [OK].
The music list screen appears.
- 3 Go to step 3 (⇒ 74, "Playing music file on the media").

Operations during music play

Stop

Press [■].

Pause

Press [⏸].

- Press [▶ × 1.3] to restart play.

Search

Press [◀◀] or [▶▶].

- Press [▶ × 1.3] to restart play.

Skip

Press [◀◀] or [▶▶].

Repeat Play/Shuffle

Refer to "Repeat Play" or "Shuffle" in Basic Operation menu (⇒ 58).

Sound Effects

Refer to "Sound Effects" in Sound Settings menu (⇒ 59).

High Clarity Sound

Refer to "High Clarity Sound" in Sound Settings menu (⇒ 59).

To play music continuously even if the Power off link works

Refer to "Playing music continuously even after turning off power to the TV". (⇒ 83)

Copying music

USB HDD **DVD-R** **+R** **CD** **※** **USB** → **HDD**

※ Except **CD** (**CD-DA**)

- 1 On the music list screen:
Select the file or folder.

e.g.,

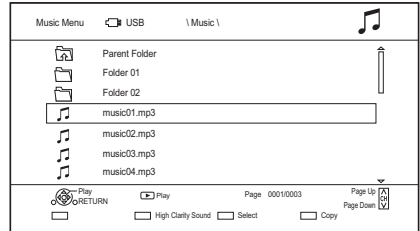

- 2 Press the blue button.
- 3 Select "Yes", then press [OK].

To stop copying

Press and hold [RETURN ⊕] for 3 seconds.

Multiple selection

Select the file or folder, then press the yellow button.

A check mark ✓ is displayed. Repeat this step.

- Press the yellow button again to cancel.



- While copying, no other operations can be performed.
Timer recordings will not proceed.
- All files in the folder will be copied.
- Up to 1000 files can be copied at once.

Deleting music

HDD

- 1 On the music list screen:
Select the file or folder.
 - Multiple selection (⇒ above)
- 2 Press the red button.
- 3 Select "Yes", then press [OK].



- All files in the folder will be deleted.

Network Service

Network Service allows you to access some specific websites supported by Panasonic, and enjoy Internet contents such as photos, videos, etc. from Network Service home screen.

e.g.,

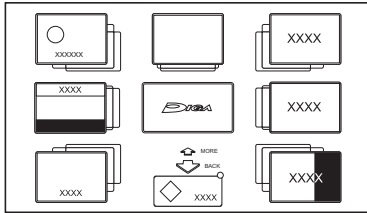

Preparation

- Perform network connection and settings. (⇒ 19, 22)

- 1 Press [INTERNET].
 - When a message is displayed, read it carefully and then press [OK].
 - NETFLIX can be accessed directly by pressing [NETFLIX] button.
- 2 Select the item, then press [OK].
 - Operable buttons: [▲], [▼], [◀], [▶], [OK], [RETURN ⊕], colour buttons and number buttons.

To exit

Press [EXIT ⊗].



- In the following cases, settings are possible using "Network Service Settings". (⇒ 99)
 - When restricting the use of Network Service.
 - When the audio is distorted.
- For information about other disclaimers. (⇒ 115, "Disclaimer")

TV Anywhere

Operations such as the ones below can be performed from anywhere with a smartphone or tablet installed with Media Center App.

- Setting a recording
- Watching TV with this unit's tuner
- Playing back programmes recorded on this unit

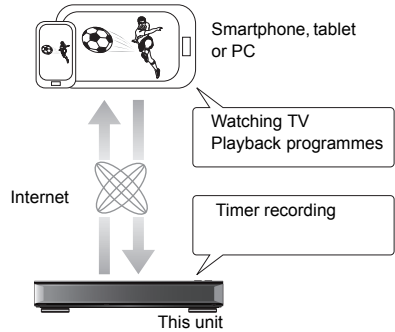

Use the Media Center App to complete user registration to use these functions.

For details, please check the following website.
<http://panasonic.jp/support/global/cs/av/mediacenter/>
 (This site is in English only.)

Preparation

- Perform network connection and settings. (⇒ 19, 22)
- TV Anywhere Settings (⇒ 99)



- This unit will always be connected to the Internet when this function is activated.
- For information about other disclaimers. (⇒ 115, "Disclaimer")

DVB-via-IP Server Function (TV>IP)

The DVB-via-IP Server Function allows you to stream TV broadcasts to a compatible device in the same network. You can watch broadcasts on a device provided with the DVB-via-IP Client function.

- It is not possible to use the DVB-via-IP Server function and another network function (Network Service / Home Network) simultaneously.

e.g.,

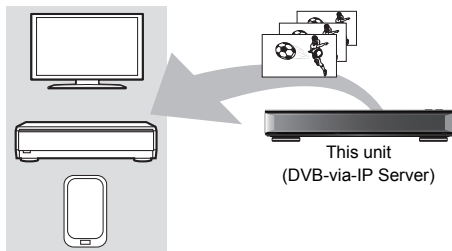

DVB-via-IP Client compatible equipment*

- * SAT>IP Client device or device installed with a SAT>IP Client app

Preparation

- Perform network connection and settings. (⇒ 19, 22)
- Set "DVB-via-IP Server" to "On". (⇒ 100)

To watch TV broadcasts on a DVB-via-IP Client device:

Operate the DVB-via-IP Client device. (For details on how to operate it, refer to its operating instructions.)



- The DVB-via-IP Server function can stream only one broadcast at a time.
- This unit will always be connected to the Internet when this function is activated.
- When the DVB-via-IP Server function is in use, the following operations cannot be performed:
 - Playing back a programme while copying another programme in Copy (Keep Picture Quality) mode.
 - Copying video/photos/music files
- **[UBC90]** It is not possible to use the DVB-via-IP Server function if you change the "TV Signal Selection" setting (⇒ Step 5 on page 20, "Easy Setting"). Change the setting of the DVB-via-IP Client device again.
- **[UBS90]** It is not possible to use the DVB-via-IP Server Function when "DiSEqC (Single Tuner)" is selected. Select a setting that allows you to use two or more tuners. (⇒ Step 6 on page 21, "Easy Setting")

Changing the Network Function Priority setting

In "Network Function Priority", priority can be given to either "DVB-via-IP Server" or "Network Service / Home Network".

Network Function Priority (⇒ 100):

- **DVB-via-IP Server**
Priority is given to the DVB-via-IP Server function.
- **Network Service / Home Network**
Priority is given to other network functions.

Home Networking (DLNA)

Home Networking (DLNA) allows you to watch the contents and broadcasts on Server equipment connected on the same network from Client equipment.

This unit can be used both as Server and Client. Additionally, if used as Client, this unit can also be used as Media Renderer, which can be controlled by a Smartphone, etc.

Preparation

- Perform network connection and settings. (⇒ 19, 22)
- Perform Home Network settings of the DLNA compatible equipment.



- Ensure that the router for your home network has adequate security system to prevent unauthorised access.
- If using slow network connection, the video may not be displayed correctly. A high-speed home network with a speed of at least 20 Mbps is recommended.
- Some video or broadcasts cannot be enjoyed depending on the DLNA (Client) compatible equipment, the condition of this unit, or the file type.

Using this unit as Server

You can watch broadcasts received by this unit (Multiroom TV Streaming), videos and photos saved on HDD of this unit on DLNA (Client) compatible equipment.

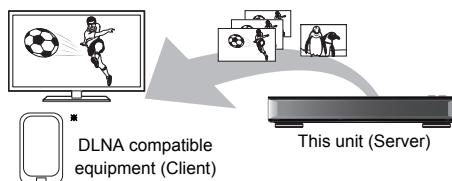

For details regarding the connection and operation of equipment connected via a network, refer to their respective operating instructions.

- * DLNA function compatible software should be installed.

Preparation

- Perform Home Network settings. (⇒ 99)

- 1 Operate the playback equipment (Client) to display the list of contents on this unit.
- 2 Select the item, then press [OK].



- The programmes with access restriction (e.g., copy restriction) signals sent from broadcasters are not available for this function.
- If video frames are dropped, change the following settings.
 - Conversion Setting for DLNA (⇒ 99)
 - Resolution Setting for DLNA (⇒ 100)
- Files not on the HDD cannot be played back.
- Playing back 3D video recorded on this unit may not work properly.
- 3D photos copied to this unit cannot be played back in 3D.

Using this unit as Client

You can share videos, photos and music stored in the DLNA Certified media server.

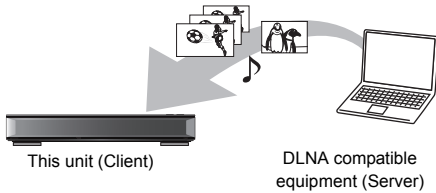

- 1** Press [FUNCTION MENU].
- 2** Select "DLNA Client" in "Home Network", then press [OK].
A list of equipment connected via the network is displayed.
 - This list can be updated by pressing the green button.
- 3** Select the equipment, then press [OK].
- 4** Select the item, then press [OK].
 - Menu structure will be different depending on the equipment. Select the contents by repeating the operation.
 - Convenient functions can be used by pressing [OPTION] depending on the contents.
- **Control Panel**
Control Panel is displayed once the playback starts.
 - Press [OK] if the Control Panel is not displayed. (It may not be displayed depending on the conditions of use.)
 - (While playing video or photo) Press [RETURN Ⓞ] to hide the Control Panel.



- Playlist of Windows Media® Player can play back only the contents that are stored in the libraries.
- While playing back the 3D programme, you cannot set "3D Settings". (⇒ 56)

Playable contents

When this unit works as a DLNA client, following contents are playable.

Video (Recorded programmes)

| Container | Video codec | Audio codec | Example of file extension |
|---------------------|------------------------|----------------------------------|---------------------------|
| XP/SP/LP/FR*1 | MPEG2 | Dolby® Digital Linear PCM | – |
| DR/HG/HX/HE/HL/HM*1 | MPEG2 H.264 HEVC | MPEG HE-AAC Dolby® Digital | – |

Video

| Container | Video codec | Audio codec | Example of file extension |
|-----------|------------------------|--|---------------------------|
| AVCHD*1 | H.264 | Dolby® Digital | .mts |
| MP4 | H.264 HEVC | AAC | .mp4 |
| PS | MPEG2 | Dolby® Digital Linear PCM | .mpg .mpeg |
| TS | MPEG2 H.264 HEVC | Dolby® Digital AAC | .m2ts .ts |
| MKV | H.264 HEVC | AAC-LC MP3 Dolby® Digital PCM Vorbis FLAC | .mkv |

Photo

| Format | Example of file extension |
|---------|---------------------------|
| JPEG | .jpg |
| MPO*1,2 | .mpo |

*1 Only when the server is another Panasonic Blu-ray Disc Recorder, etc.

*2 2D playback only.

Audio

| Audio codec | Example of file extension |
|-------------|---------------------------|
| MP3 | .mp3 |
| WAV | .wav |
| AAC | .m4a, .adts |
| WMA | .wma |
| FLAC | .flac |
| DSD | .dsf, .dff |
| ALAC | .m4a |
| Linear PCM | – |

- Depending on the server, the contents other than stated above can be played back.

Using this unit as Media Renderer

This unit works as Media Renderer, which allows you to play back the contents on DLNA Server by operating a Digital Media Controller (a smartphone, etc.).

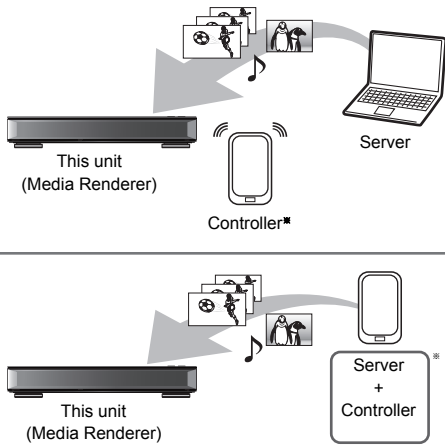

* Digital Media Controller compatible software should be installed.

Following steps are necessary to use this unit as Media Renderer.

- 1 Press [FUNCTION MENU].
- 2 Select "Media Renderer" in "Home Network", then press [OK].
- 3 Operate the Digital Media Controller compatible equipment.

To exit from Home Network (Media Renderer) screen

Press [RETURN ⊖].

Using Home Networking (DLNA) with Wi-Fi Direct®

Wi-Fi Direct is a standard that enables wireless LAN devices to communicate each other directly without a wireless broadband router. This unit can be connected wirelessly and directly to other DLNA compatible equipment on a temporary basis, regardless of the network connection and settings of this unit.

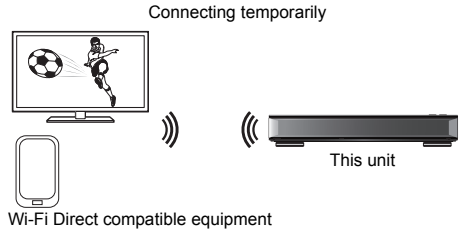

- 1 Press [FUNCTION MENU].
- 2 Select "Wi-Fi Direct" in "Home Network", then press [OK].
- 3 Select the item, then press [OK].
 - Set up the device to be connected so that a Wi-Fi Direct connection can be made. For details, refer to the operating instructions for the device to be connected.
- 4 Select the device to be connected, then press [OK].
 - If the device you want to connect to is not displayed, switch the connection method by pressing the yellow button.
- 5 **When selected "DLNA Client":**
Go to step 4 on page 79.
When selected "DLNA Server":
Operate the playback equipment (Client).
When selected "Media Renderer":
Operate the Digital Media Controller.

When no devices are found

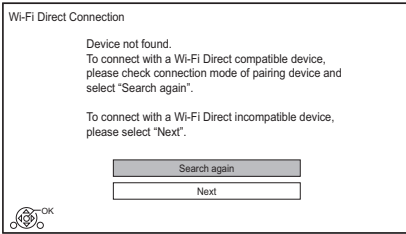

If the corresponding device is not found even after the search is run again, select "Next" and change the connection method.

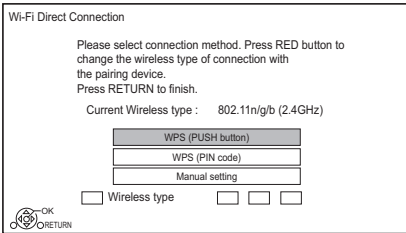

Select the connection method according to the device to be connected.

Using Miracast®

You can enjoy the content you are viewing on a Miracast-compatible smartphone, etc. on the big screen of your TV.

- Compatible with Android™ device, ver. 4.2 and above and Miracast certified.
- For information on whether the smartphone, etc. supports Miracast, contact the manufacturer of the device.

Miracast compatible equipment

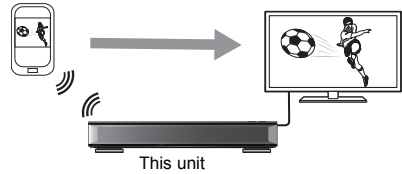

- 1 Press [FUNCTION MENU].
- 2 Select "Miracast" in "Home Network", then press [OK].
- 3 Operate the Miracast compatible equipment.

To exit from Miracast

Press [EXIT ⊗].

Copying the HD Video (AVCHD)



* "For data files (⇒ 27)" only

e.g.,

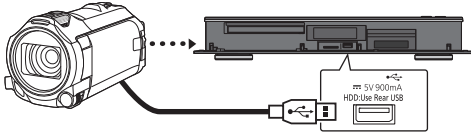

USB connection cable
(optional)

- 1** Connect a video camera that has been turned on or insert a media.
 - Make the video camera ready for data transfer.

The menu screen of this unit appears. (⇒ 52)
- 2** Select "Copy Video (AVCHD)", then press [OK].
- 3** If the copying destination selection screen is appeared:
Select "Copy to HDD" or "Copy to Blu-ray Disc", then press [OK].
- 4** Select a programme stored on the video camera, then press the yellow button.
A check mark is displayed. Repeat this step.
 - Press the yellow button again to cancel.

- 5** Press [OK].
- 6** Select "Start", then press [OK].
It will automatically format the unformatted disc, such as a new disc.
 - It may take time for the copying to start.

To stop copying

Press and hold [RETURN ⊕] for 3 seconds.

Screen icons

About other screen icons

Refer to "Screen icons". (⇒ 48)

VIERA Link

What is VIERA Link?

VIERA Link is a convenient function which will link the operations of this unit and a Panasonic TV (VIERA) or an amplifier/receiver. You can use this function by connecting the equipment with the HDMI cable. See the operating instructions for connected equipment.

Automatic input switching/ Power on link

When the following operations are performed, the input channel of the TV will be automatically switched and the screen of this unit will be displayed. Additionally when the TV is off, the TV will automatically turn on.

- When play starts on this unit
- When an action that uses Video Menu etc, is performed

Power off link

When you set the TV to standby mode, this unit is also automatically set to standby mode.

- Power off link function does not work when recording, copying etc.

Playing music continuously even after turning off power to the TV

The following operations make it possible to keep the power of the unit on and to play music continuously.

When the unit is directly connected to an amplifier/receiver.

- 1 While playing music
Press [OPTION].
 - 2 Select "TV Power Off", then press [OK].
- Sound may be discontinued for several seconds when the power to the TV is turned off.

Easy control only with Panasonic TV's remote control

You can operate this unit using the TV remote control.

Refer to the operating instructions of the TV about the buttons that you can use.



- VIERA Link, based on the control functions provided by HDMI which is an industry standard known as HDMI CEC (Consumer Electronics Control), is a unique function that we have developed and added. As such, its operation with other manufacturers' equipment that supports HDMI CEC cannot be guaranteed.
- These functions may not work normally depending on the equipment condition.
- Use the remote control supplied with this unit if you cannot operate this unit using buttons on the TV remote control.
- The information provided on this page is correct as of March 2017 and is subject to change.

Software (Firmware) Update

You cannot operate the unit until the update is complete. Don't remove the AC mains lead during the update. Removing the AC mains lead while the update is in progress may damage the unit.

Update software (firmware) of this unit

Software of this unit can be updated automatically by the following methods at the specified time.

• From broadcasts

(Default setting is 3 a.m. ⇒ 102, Software Update in Standby)

• UBC90

DVB-C The CATV terminal connection is not applicable to this function.

• From Internet

Network connection and setting are required. (⇒ 19, 22)

If a software (firmware) update is available, a notification is displayed.

New software version has been found.
The software will be updated automatically after this unit is switched to standby.
Do not disconnect the AC mains lead.

Update of the software (firmware) will start when the unit is turned to standby mode.

To update the software (firmware) immediately

Use the "Software Update Now (Broadcast)" function or "Software Update Now (Internet)" function. (⇒ 102)

• UBC90

DVB-C Some cable providers do not support this function.



- It may take up to a few hours until the update is completed depending on the network environment.
- The timer recording always takes preference over the software (firmware) download; if the timer recording is scheduled to start, the downloading will be performed at the next opportunity.
- You can also download the latest software (firmware) from the following website.
<http://panasonic.jp/support/global/cs/>

CI Plus compatible CAM software (firmware) update

Software (firmware) of CAM (compatible CI Plus) can be updated automatically from broadcasts. Availability of software (firmware) update is detected while viewing the programmes that are compatible with CI Plus.

1 When notification is displayed on the screen, select "Yes" and press [OK].

- If for some reason the notification is not displayed, or if cancelled, the notification is instead displayed on the channel information (⇒ 31).

e.g.,

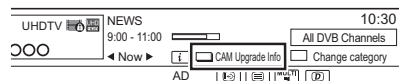

To execute CAM software upgrade, press the red button.

2 Follow the instructions on the screen.



- Operations such as view, playback, or record cannot be performed while upgrading the CAM. Any buttons on the remote control or the unit cannot be used while upgrading the CAM.
- If the timer recording is started, CAM software upgrade is cancelled to start recording.
- For details, refer to your CAM's operating instructions or consult your dealer.

Other operations

Media management

BD-RE **BD-R** **RAM** **DVD-R** **DVD-RW** **+R** **+RW**

SD

- 1 Press [FUNCTION MENU].
- 2 Select "Media", then press [OK].
- 3 Select the media, then press [OK].
- 4 Select the item, then press [OK].
 - Selectable items will change depending on the selected item and inserted media.

Disc Name

BD-RE **BD-R** **RAM** **DVD-R** **DVD-RW** **+R** **+RW**

This function is to name a disc.
Refer to "Entering text". (⇒ 87)

- The disc name is displayed in the Blu-ray Disc Management/DVD Management window.
- **DVD-R** **DVD-RW** **+R** With a finalised disc, the name is displayed on the Top Menu.
- **+RW** The disc name is displayed only if you play the disc on other equipment after creating Top Menu.



- Do not perform this operation before copying HD Video (AVCHD) to DVD-R or DVD-R DL. (⇒ 70)

Disc Protection

BD-RE **BD-R** **RAM**

Select "Yes", then press [OK].

e.g.,

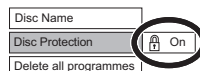

- To release the protection Repeat the same steps.
- The screen icon will be switched to "Off".

Delete all programmes

BD-RE **BD-R** **RAM**

- 1 Select "Yes", then press [OK].
- 2 Select "Start", then press [OK].



- Photo data (JPEG/MPO) or computer data cannot be deleted.

Format Disc/Format SD Card

BD-RE **RAM** **DVD-RW** **+RW** **SD**

BD-R **+R** (New disc only)

Formatting deletes all contents (including computer data), and they cannot be restored. Check carefully before proceeding.

- 1 Select "Yes", then press [OK].
- 2 Select "Start", then press [OK].
- 3 Press [OK].

RAM To stop formatting

Press [RETURN ⊙].

- You can cancel formatting if it takes more than 2 minutes. The disc must be reformatted if you do this.



- **Do not disconnect the AC mains lead while formatting.** This can cause the disc unusable.
- The contents are deleted when you format a disc or card even if you have set protection.
- When a disc or card has been formatted using this unit, it may not be possible to use it on any other equipment.
- It will become DVD Video format when a DVD-RW recorded in DVD Video Recording format is formatted with this unit.
- **RAM** Formatting normally takes a few minutes; however, it may take up to a maximum of 70 minutes.

Top Menu

DVD-R **DVD-RW** **+R** **+RW**

You can select the background for DVD-Video Top Menu.

Select the background, then press [OK].

Auto-Play Select

DVD-R **DVD-RW** **+R** **+RW**

You can select whether to show the Top Menu after finalising or creating Top Menu.

Select "Top Menu" or "Title 1", then press [OK].

Top Menu:

The Top Menu appears first.

Title 1:

The disc content is played without displaying the Top Menu.

Finalise

DVD-R **DVD-RW** **+R** (You can play the disc on compatible DVD players by finalising it on the unit.)

BD-R (Finalising BD-R prevents accidental recording or editing.)

- 1 Select "Yes", then press [OK].
- 2 Select "Start", then press [OK].
- 3 Press [OK].

After finalising

- **BD-R** **DVD-R** **+R** The disc becomes play-only and you can no longer record or edit.
- **DVD-RW** You can record and edit the disc after formatting.



- **Do not disconnect the AC mains lead while finalising.** This can cause the disc unusable.
- You cannot cancel finalising.
- Finalising takes up to 15 minutes (Up to 60 minutes in case of DVD-R DL and +R DL).
- Depending on the disc, it may take longer than displayed on the confirmation screen (approximately four times longer).
- You cannot finalise discs recorded on other manufacturer's equipment.
- **DVD-R** **DVD-RW** **+R** If you finalise discs recorded on Panasonic equipment other than this unit, the background selected as "Top Menu" may not be displayed.
- Discs finalised on this unit may not be playable on other players due to the condition of the recording.

Create Top Menu

+RW

You can create Top Menu for displaying on other equipment.

Make selections from "Top Menu" and "Auto-Play Select" before creating Top Menu.

- 1 Select "Yes", then press [OK].
- 2 Select "Start", then press [OK].
- 3 Press [OK].



- You cannot use the Top Menu for playing on this unit.
- The created menu is deleted when you record or edit the disc.

HOLD function

The HOLD function deactivates all buttons on the unit and remote control.

Press and hold [OK] and [RETURN ⊖] simultaneously until "X HOLD" appears on the front panel display.

To cancel the HOLD function

Press and hold [OK] and [RETURN ⊖] simultaneously until "X HOLD" disappears.

Entering text

Preparation

- Show the "Enter Programme Name" screen, etc.

- 1 Select a character, then press [OK].
Repeat this step to enter other characters.

e.g.,

Name field: shows the text you have entered

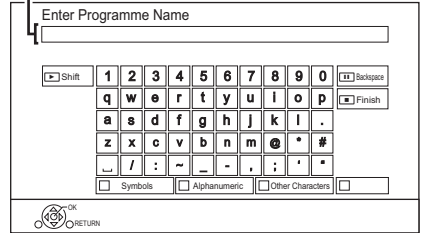

- Red: Enter Symbols
- Green: Enter Alphanumeric characters
- Yellow: Enter Other Characters, such as umlaut mark or accent grave
- [█]: Delete a character
- [▶ ×1.3]: Shift the alphabetic characters on the screen to upper case/lower case

- 2 Press [█] (Finish).
"Writing..." appears then the screen returns to the previous screen and so on.

To end partway

Press [RETURN ⊖]. (Text is not added.)



- The maximum number of characters depends on the media.

Basic Settings

You can change the unit's settings of DVB Tuning, Sound, Display, Connection, Network etc. in the menu.

- 1 Press [FUNCTION MENU].
- 2 Select "Basic Settings" in "Setup", then press [OK].

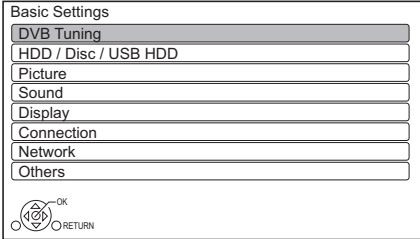

- 3 Select the menu, then press [OK].
- 4 Select the item, then make the setting.

To return to the previous screen

Press [RETURN ⊖].

UBC90 DVB Tuning

Favourites Edit

You can create four favourites of channels for making viewing and recording easier.

After editing as follows, save the Favourites.

Press [RETURN ⊖], then press [OK].

- To select the other Favourites list:
Press the green button.
- To add channels to the Favourites list:
Select the channel in the "All DVB Channels" column, then press [OK]. Repeat this step.
 - Red: Change the sorting mode.
 - Yellow: Add continuous block of channels to the list at once.
 - Press [▲, ▼] to make the block, then press [OK].
 - Blue: Select the Category.
- To change the order of the channels list:
 - 1 Select the channel in the "Favourites" column to move, then press the green button.
 - 2 Select the new position, then press the green button.
- To delete channels:
Select the channel in the "Favourites" column, then press [OK].
 - Yellow: Delete all channels.
- To change the name of the Favourites list:
 - 1 Press the red button in the "Favourites" column.
 - 2 Press [▲, ▼, ◀, ▶] to select a character, then press [OK].
Repeat this step to enter other characters.
 - Red: Delete a character.
 - Blue: Delete all characters.
 - 3 Press [RETURN ⊖].

Auto Setup

You can restart the Auto Setup. (⇒ 20)

- 1 Select "Yes", then press [OK].
 - If the country selection screen appears:
Select the country, then press [OK].
- 2 Follow the on-screen instructions and make the following settings.

DVB-C

- 1 Select "Digital Cable Channels", then press [OK].
- 2 Select "Preset Channel Number" or "Operator's Channel Number (LCN)", then press [OK].
- 3 Select the items and change the items. (For details, consult the cable provider.)

Search Mode

- All Channels
- Free Channels

Scan Mode

- Quick:
Scans the suitable frequency for the selected country.
- Full:
Scans the whole frequency range.

Frequency/Symbol Rate/Network ID

Normally set to "Auto".

If "Auto" is not displayed or if necessary, enter the value specified by your cable provider with number buttons.

- 4 Select "Start scan", then press [OK].
Auto Setup starts.

DVB-T DVB-T2

Select "Digital Terrestrial Channels", then press [OK].

Auto Setup starts.



- The timer recording programmes are cancelled.
- If the channel you are looking for is not found, select "Full" for "Scan Mode". (⇒ above)

DVB-C Settings for DVB-C Channels

DVB-T DVB-T2 Settings for DVB-T Channels

Channel List

You can edit the channel list.

- To hide/reveal channels
 - 1 Select the channel.
 - 2 Press [OK].
The check mark is removed/displayed.
 - Red: Change the sorting mode.
 - Yellow: Reveal all channels.
 - Blue: Change the Category.
- To move the channel number assignment
 - 1 Select the channel to move, then press the green button.
 - 2 Enter the channel number to reassign with the number buttons.
 - 3 Press [OK].

Manual Tuning

You can add new channels manually.

DVB-C

- 1 Adjust the frequency, symbol rate and service ID. (For details, consult the cable provider.)
 - Adjust the frequency by checking the signal strength and signal quality displays.
- 2 Select "Start scan", then press [OK].
 - The set channel is displayed in the table.

DVB-T DVB-T2

- 1 Press [▲, ▼] to select the frequency.
 - Adjust the frequency by checking the signal strength and signal quality displays.
- 2 Press [OK] to start scan.
 - The set channel is displayed in the table.

Update Channel List

You can update the channel list to the latest one.

Signal Condition

You can check the quality and strength of signals.

Press [CH ^ v] to select the channel.



DVB-C

- When the signal is too strong (red bar), reduce the CATV signal. (For details, consult your dealer or the cable provider.)
- When the signal is weak, check that the current broadcast channel is correctly broadcasting.

DVB-T | DVB-T2

- The channels you can receive are affected by weather conditions, seasons, time (day/night), region, length of the cable that is connected to the aerial, etc.
- When the signal is too strong (red bar), reduce the signal amplification at your aerial. (For details, consult your dealer.)

New Channel Message

Set whether to obtain the information automatically when a new DVB channel is added.

Child Lock

You can restrict the viewing/playback/recording of channels unsuitable to children.

- PIN is required to change. (⇒ 32)

Child Lock List

- 1 Select the channel or AV input to lock.
- 2 Press [OK].
 - is displayed.
 - Press [OK] again to cancel.
 - Green: Lock all channels.
 - Yellow: Unlock all channels.

Parental Rating

Set a ratings level to limit broadcast viewing and playback.

- Follow the on-screen instructions.

Preferred Language

Select the language for multi broadcast.

If the selected language is not available, the original language will be selected.

Audio Preference

Select the audio preference (Multichannel, Stereo or MPEG). The type of audio to be output when you watch a TV programme or play back a recorded programme will be determined by the selected preference.

- This is displayed only when Germany is set as your country of residence in "Easy Setting". (⇒ 20, 21)

Audio Description

When "Automatic" is selected, Audio Description will be set as default while watching.



- When "Dolby D / Dolby D + / Dolby TrueHD" or "HE-AAC" is set to "Bitstream", the Audio Description may not work. Set them to "PCM" (⇒ 95, Digital Audio Output).

HbbTV Setting

Turn on/off the HbbTV service.

- When "On" is selected, HbbTV service are available.

Favourites Edit (⇒ 88)

Auto Setup

You can restart the Auto Setup. (⇒ 21)

- 1 Select the Auto Setup method, then press [OK].
 - Search by selected satellite
Transponders for the already found satellite are searched for channels.
 - Search all satellites
All satellites and transponders are searched for channels.
- 2 Select "Yes", then press [OK].



- The timer recording programmes are cancelled.

Settings for DVB-S Channels

Channel List (⇒ 89)

Manual Tuning

You can add new channels manually.

- 1 Select the items and change the items.
 - Change the items by checking the signal strength and signal quality displays.
- 2 Select "Start scan", press [OK] to start scan.
 - The set channel is displayed in the table.

Update Channel List

You can update the channel list to the latest one.

- 1 Select the method and settings.

Search Mode

- Free Channels
- All Channels

Scan Mode

- Quick
Scans the suitable frequency for the selected satellite.
- Full
Scans the whole frequency range.

- 2 Press [OK].

The unit starts searching for newly available satellite digital channels.



- If the channel you are looking for is not found, select "Full" for "Scan Mode". (⇒ above)

Exchange Channel List

Exports/Imports DVB-S Channel List settings using the USB device to share the same settings with another DIGA which has the same function.

- Export Channel List
You can export the channel list of this unit to the USB device.
- Import Channel List
You can import the channel list of another DIGA from USB device.

Signal Condition

You can check the quality and strength of signals.

- Press [◀, ▶] to select the tuner.
- Press [CH ^ v] to select the channel.



- The channels you can receive are affected by weather conditions, seasons, time (day/night), region, length of the cable that is connected to the aerial, etc.
- When the signal is too strong (red bar), reduce the signal amplification at your aerial.
- When the signal is weak:
 - adjust the position and direction of the dish.
 - check that the current digital broadcast channel is correctly broadcasting.

Antenna System

You can receive several satellites if you have DiSEqC control antenna system or single cable router.

- 1 Select "Antenna System".
- 2 Press [◀, ▶] to select antenna system.
 - One LNB
Compatible with Single LNB.
 - MiniDiSEqC
Up to 2 LNBs can be controlled.
 - DiSEqC1.0
Up to 4 LNBs can be controlled.
 - Single Cable
Compatible with single cable router.

LNB Configuration

You can set LNB setting and User Band when necessary.

- If you do not know the connected satellite, select "No Satellite" in "Satellite". (Available satellite will be searched in Auto Setup.)
- If you select "User defined" in "Satellite", set "Test Transponder Frequency" manually.

Preferred Language (⇒ 90)**Audio Preference (⇒ 90)****Audio Description (⇒ 90)****HbbTV Setting (⇒ 90)****Settings for Playback****3D BD-Video Playback**

Select the playback method of 3D compatible video software.

Soundtrack

Select the audio language.

- Enter a code with the number buttons when you select "Other ****".
(⇒ 114, Language code list)

Subtitles

Select the language for subtitle.

- Enter a code with the number buttons when you select "Other ****".
(⇒ 114, Language code list)

Menu

Select the language for disc menus.

- Enter a code with the number buttons when you select "Other ****".
(⇒ 114, Language code list)

BD-Live

You can restrict Internet access when BD-Live functions are used.

- If "On (Limit)" is selected, Internet access is permitted only for BD-Live contents which have content owner certificates.

BD-Video Parental Control

Set an age limit of BD-Video play.

- PIN is required to change. (⇒ 32)

DVD-Video Parental Control

Set a rating level to limit DVD-Video play.

- PIN is required to change. (⇒ 32)

Subtitle Text

Select the language for MKV subtitles text.

- This item is displayed only after playing back a MKV file with subtitle text.

Pure Sound mode

You can enjoy movies or music in an environment more suitable for viewing by stopping the rotation of the HDD when playing back commercial BD-Videos, DVD-Videos or music CDs.

- If "On" is selected, timer recording does not start while playing back BD-Video, DVD-Video or music CD.

Settings for Recording

Timer Record Start Buffer

This function sets the timer recording to start earlier than the TV Guide time.

Timer Record Stop Buffer

This function sets the timer recording to stop later than the TV Guide time.

REWIND LIVE TV

Turn on/off the REWIND LIVE TV function.

Recording for Encrypted Channel

The function allows you to change the recording limitation on the encrypted programme. (⇒ 37)

UBS90

- "Automatic" cannot be selected in the following cases.
 - "DiSEqC (Single Tuner)" has been selected in "Easy Setting" or "Auto Setup". (⇒ 21, 91)
 - When "DVB-via-IP Server" is set to "On". (⇒ 100)

PIN Entry for Decrypt Recording

If your CAM requires a PIN for timer recording, it can be entered here in advance.

Aspect for Recording

Sets the aspect ratio when recording or copying except in DR mode.

- "HG", "HX", "HE", "HL" or "HM" mode:
If "Automatic" is selected, the programme will be recorded with the original aspect ratio.
- "XP", "SP", "LP" or "FR" mode:
If "Automatic" is selected, the programme will be recorded with the original aspect ratio at the time when recording started (including when recording started at a commercial, etc.).
- In the following cases, aspect is fixed to 4:3.
 - When copying to a +R, +R DL and +RW.

Chapter Creation

Set the Chapter Creation method.

- Even if "Automatic" is selected, depending on the programme to be recorded, the chapter may not be created correctly.

Disc Speed for Copy

Select the speed for Copy (Keep Picture Quality).

HDD Management

Press and hold [OK] for 3 seconds to show the following settings.

Delete all programmes

Delete all recorded programmes and AVCHD on the built-in HDD.

- Delete does not work if one or more programmes are protected.

Delete all videos (MP4 / MKV)

Delete all videos (MP4/MKV) on the built-in HDD.

Delete all photos

Delete all photos on the built-in HDD.

Delete all music

Delete all Music on the built-in HDD.

Format HDD

Formatting deletes all contents on the built-in HDD, and they cannot be restored. Check carefully before proceeding.

Settings for USB HDD

USB HDD Registration

Register the USB HDD. (⇒ 46)

USB HDD Disconnection

This function puts the USB HDD in a state in which it can be safely disconnected. (⇒ 46)

USB HDD Management

Press and hold [OK] for 3 seconds to show the following settings.

Delete all programmes

Delete all programmes on the USB HDD.

- Delete does not work if one or more programmes are protected.

Format USB HDD

Formatting deletes all contents, and they cannot be restored. Check carefully before proceeding.

Cancellation of all USB HDD Registrations

This function cancels the registrations of all the USB HDDs registered on this unit.

Only do this if you are going to dispose of this unit.



- Before operation, perform "USB HDD Disconnection" (⇒ above) and remove the USB HDD.

Picture

Still Mode

Select the type of picture shown when you pause play.

- Field:
Select if jittering occurs when "Automatic" is selected. (The picture is coarser.)
- Frame:
Select if small text or fine patterns cannot be seen clearly when "Automatic" is selected. (The picture is clearer and finer.)

Sound

Dynamic Range Compression

To lower the dynamic range for playback (e.g., at night).

- This does not work depending on broadcasts and recorded programmes.

Downmix

Select the downmix system of multi-channel to 2-channels sound.

- Select "Surround encoded", when the connected equipment supports the virtual surround function.
- There is no effect on "Bitstream" via HDMI AV OUT and DIGITAL AUDIO OUT terminal.
- The audio will be output in "Stereo" in the following cases.
 - AVCHD playback
 - [BD-V] : Playback of clicking sound on the menu and audio with secondary video in picture-in-picture mode.

Bilingual Audio Selection

Select whether to record the audio type ("M1" or "M2") when:

- Picture Quality Change (⇒ 61)
- Copying to a DVD-R, DVD-RW, +R and +RW.

PCM Down Conversion

Check the sampling frequencies supported by the coaxial input of the connected device. If the device does not support certain sampling frequencies, set the appropriate frequency setting.

- On (48 kHz):
The maximum sampling frequency of signals is limited to 48 kHz.
(Choose if the connected device does not support signals with a sampling frequency of 96 kHz or 192 kHz.)
- On (96 kHz):
The maximum sampling frequency of signals is limited to 96 kHz.
(Choose if the connected device does not support signals with a sampling frequency of 192 kHz.)
- Off:
Signals are output as 192 kHz.

Dolby D / Dolby D + / Dolby TrueHD

DTS / DTS-HD

MPEG

HE-AAC

Select the audio signal to output.

- Select "PCM" when the connected equipment cannot decode the respective audio format.
- Not making the proper settings may result in noise.

System Volume Adjustment

If the volume of a programme being watched through this unit is different than the volume of a programme being watched directly on the TV, the gap may be reduced by switching this setting to Mode 1 or Mode 2. (This function works only while you are watching a programme or playing back a programme recorded in DR mode with this unit.)

BD-Video Secondary Audio

Turn on/off the clicking sound on the menu and audio with secondary video.



- To enjoy BD-Video that supports Dolby Atmos® or DTS:X™
Connect this unit to an AV amplifier or similar device that supports it with an HDMI cable, and select the following settings:
 - Dolby D / Dolby D + / Dolby TrueHD: "Bitstream"
 - DTS / DTS-HD: "Bitstream"
 - BD-Video Secondary Audio: "Off"Dolby Atmos is a trademark of Dolby Laboratories.

HDMI Output Settings of Music Playback

Select the HDMI output settings.

- If "Sound Quality Priority" is selected, the audio noise is minimised during music playback by automatically switching the video output to 1080i.

Settings for High Clarity Sound

This function is effective when "High Clarity Sound" (⇒ 59) is set to "On (Video Off)" or "On (Video On)".

Audio Output

Select the terminal from which you want to output audio signals. (⇒ 14 - 18)

- Set an option for video playback and audio playback.

Front Panel Display

Select whether or not to turn on/off the front panel display.

- Set an option for video playback and audio playback.

Audio Delay

Mis-sync between the video and audio is corrected by delaying the audio output.

Audio for HG / HX / HE / HL / HM Recording

If the programme has multi channel audio (5.1 ch or 2 ch), priority is given to what you select.

- This setting will give effect in the following cases.
 - Timer recording (⇒ 39)
 - Picture Quality Change (⇒ 61)
 - Copy (Picture Quality Change) in HG, HX, HE, HL or HM mode from a programme recorded in DR mode. (⇒ 66, 68)

Display

Language

Select the language for on-screen menus.

On-Screen Information

Select the time until the channel information screen (⇒ 31) disappears automatically.

Front Panel Display

Changes the brightness of the front panel display.

- If “Automatic” is selected, the display turns dark during play and disappears when the unit is in standby mode. While using this mode, the standby power consumption can be reduced.
- When “Quick Start” is set to “Off” or “Timer Setting for Quick Start” (⇒ 101), this function is fixed to “Automatic”.

Screen Saver

This is to prevent image retention on the screen.

Teletext

Select the Teletext (⇒ 31) display mode.

Connection

3D Settings

3D AVCHD Output

If 2D AVCHD video is recognised as 3D video and cannot be played back correctly, you may be able to play it by changing the setting.

3D Playback Message

Set to display or hide the 3D viewing warning screen.

VIERA Link

Select “Off” when you do not want to use VIERA Link.

Aspect for 4:3 Video

To play a 4:3 content, set how to show pictures on a 16:9 TV.

- 4:3:
Picture output expands left or right.
- 16:9:
Picture is output as original aspect with side panels.

TV System

Set in accordance with the TV System for the connected TV.

HDMI Connection Settings

Video Format

You can only select items compatible with the connected equipment.

- If “Automatic” is selected, the output resolution best suited to the connected TV (4K, 1080p, 1080i, 720p or 576p/480p) is automatically selected.

4K(50p/60p) Output

This unit automatically chooses to output images in 4K (50p/60p) when connected to a 4K (50p or 60p) compatible TV.

- This item is available only when “Video Format” is set to “Automatic” and “4K”.
- This item is not available when “HDMI(AUDIO) Output Mode” is set to “Video+Audio”.
- To connect to a TV that supports 4K (50p/60p) 4:4:4/8 bit or 4K (50p/60p) 4:2:2/12 bit, select “4K(50p/60p) 4:4:4”.
- Images will not be output correctly with an HDMI cable that does not support 18 Gbps.
- To connect to a TV that supports 4K (50p/60p) 4:2:0/8 bit, select “4K(50p/60p) 4:2:0”.

24p Output

When playing BD-Video recorded in 24 frames, this unit displays each frame at 1/24 second intervals—the same interval originally shot with the film movie.

- When this unit is connected to TV compatible with 4K/24p and “Video Format” is set to “Automatic”, images will be output in 4K/24p.
- When this unit is connected to a TV compatible with 1080/24p and “Video Format” is set to “Automatic”, “1080i” or “1080p”, images will be output in 1080/24p.



- When BD-Video images other than 24p are played, images are output at 60p.
- This unit cannot output 4K image when playing back in 3D.

HDMI(VIDEO) Output Mode

Set whether or not to output audio from the HDMI VIDEO OUT terminal.

- When an amplifier is connected to the HDMI AUDIO OUT terminal and this menu item is set to “Automatic (Video Only / Video+Audio)”, the TV may not output audio. In that case, select “Video+Audio”.

HDMI(AUDIO) Output Mode

Set whether or not to output images from the HDMI AUDIO OUT terminal.

- It is not possible to output 3D, 4K or HDR content from the HDMI OUT terminal when “Video+Audio” is selected.

Advanced Settings

Press [OK] to show the following settings:

Colour Mode

This setting is for selecting colour-space conversion of the image signal.

Deep Colour Output

Set the output method to be used when this unit is connected to a TV that supports Deep Colour.

HDR (High Dynamic Range) Output

Output images in HDR (High Dynamic Range) format depending on the content and connected TV.

HLG / PQ Conversion

Set whether or not to convert HDR (High Dynamic Range) videos in HLG format to PQ format before outputting them when this unit is connected to a TV that supports only HDR (PQ) format.

- When “HDR (High Dynamic Range) Output” is set to “Off”, this setting is disabled.

Audio Output

Select “Off” when connected to an amplifier/receiver with a DIGITAL AUDIO OUT terminal.

7.1ch Audio Reformatting

BD-V

Surround sound with 6.1 ch or less is automatically expanded and played back at 7.1 ch.

- If "Off" is selected, sound is played over the original number of channels. (Note that in the case of 6.1 ch audio, playback will be at 5.1 ch)

Audio reformatting is enabled in the following cases:

- When you have selected "PCM" in "Digital Audio Output". (⇒ 95)
- When the audio is Dolby Digital, Dolby Digital Plus, Dolby TrueHD or LPCM.

Contents Type Flag

If "Automatic" is selected, the optimal method of playback depending on the TV (e.g. cinema) will automatically be selected (only when the TV supports Contents Type Flag).

Common Interface

Access to software contained on CI module. (⇒ 9)

- Select "Slot 1:" or "Slot 2:" and press [OK].
Follow the on-screen instructions.



- On-screen instructions may not correspond to the remote control buttons.
- For more information about TV service, please contact your service provider.
- Depending on the card, in some cases its use together with this unit may be limited or not possible.

Network

Easy Network Setting

Press [OK] to start Easy Network Setting. (⇒ 22)

Network Settings

LAN Connection Mode

Select the LAN connection method.

- When not using wireless LAN (when turning it off), select "Wired".

Wireless Settings

This allows to set and check the connection settings of the Wireless router.

Search for wireless network

WPS (PUSH button)

WPS (PIN code)

Manual setting

Select a connection method to wireless access point.

IP Address / DNS Settings

Check the connection of the network or set the IP address and DNS.

- To set the IP address and DNS
 - 1 Set "IP Address Auto-Assignment" and "DNS-IP Auto-Assignment" to "Off".
 - 2 Select the item, then press [OK] to show the respective setting.
- When the router's DHCP server function is not activated, check the numbers of other connected devices such as personal computers, then assign a number different from those of other devices for the "IP Address" and assign the same number for "Subnet Mask" and "Gateway Address".

Proxy Server Settings

Check and set the connection to the Proxy server.

- Press [OK] to show the respective setting.

Network Service Settings

Second Screen Browsing

When this function is set to "On", you can enjoy the content you are viewing on a Network Service application of smartphone, etc. with the home network on the big screen of your TV.

Lock

You can restrict using Network Service.

- PIN is required to change. (⇒ 32)

Automatic Volume Control

Volume is adjusted automatically to the standard volume while using Network Service.

- Depending on contents, this function will not work.
- Select "Off" when the audio is warped.

Notice

Displays the terms of service for the cloud services.

- You must agree to the terms of use for the Internet function and the privacy policy.

TV Anywhere Settings

You must register to a service to use this function.

TV Anywhere

When you control this unit from a smartphone or a tablet away from home, set this function to "On". (⇒ 76)

Device ID

This is the device ID and device password required for registering to and using a service. (⇒ 76)

Initialize Device Password

The device password for this unit is initialized. (⇒ 76)

- When you initialize the device password, you will not be able to use TV Anywhere. To use the TV Anywhere again, you must re-register to the service.

Home Network Settings

You can set the DLNA (Server) function. (⇒ 78)

Home Network function

You can switch between enable/disable of the DLNA (Server) and DMR (Media Renderer) function.

- If "On" is selected, the setting for "Quick Start" is fixed to "On". (⇒ 101)
- If "Off" is selected, the setting for "TV Anywhere" and "Networked Standby" is fixed to "Off". (⇒ left, 101)
- When you set "Networked Standby" to "On", the setting for this function will also be changed to "On", but "Quick Start" will remain set to "Off".
- This cannot be set to "On" if the connection with the wireless broadband router is not encrypted in the wireless connection.

Setting device name

It is also possible to change the name of this unit on the network.

- Select from a preset list
Select the preset name, then press [OK].
- Create name
Enter the name.
Refer to "Entering text". (⇒ 87)

Conversion Setting for DLNA

- On:

When playing back on DLNA (Client) compatible equipment, this setting reduces the chance of break-ups and freezing of an image by lowering the image quality.



- When this is set to "On", switching the channel or starting playback will take longer.

Resolution Setting for DLNA

When "Conversion Setting for DLNA" is set to "On", select the image quality.

Registration type for remote devices

- Automatic:
All connected devices on the same network can access this unit.
- Manual:
Only registered devices can access this unit.

Remote device list

- To register equipment manually
 - 1 Select the device name or the MAC Address for the device you want to register, then press [OK].
 - 2 Select "Yes", then press [OK].
- To deregister equipment
 - 1 Select the registered equipment, then press [OK].
 - 2 Select "Yes", then press [OK].



- This function cannot be enabled when "Automatic" is selected in "Registration type for remote devices". (⇒ above)
- The maximum number of equipment that can be registered is 16.

DVB-via-IP Server Function

DVB-via-IP Server

Turn on/off the DVB-via-IP Server function.

- If "On" is selected, the setting for "Quick Start" is fixed to "On". (⇒ 101)

Network Function Priority

It is not possible to use the DVB-via-IP Server function and another network function (Network Service / Home Network) simultaneously.

Priority can be given to either of these functions. (⇒ 77)

- DVB-via-IP Server:
Priority is given to the DVB-via-IP Server function. When using the DVB-via-IP Server function, it is not possible to use another network function on this unit. Conversely, when using the network function on this unit, it is not possible to use DVB-via-IP Server function.
- Network Service / Home Network:
Priority is given to other network functions. When using the DVB-via-IP Server function, if you use another network function on this unit, the former stops. Conversely, when using another network function on this unit, it is not possible to use the DVB-via-IP Server function.

Standby Settings

Quick Start

- On:
It is possible to start quickly from standby mode.
- Off:
Power consumption in standby mode is minimised. (⇒ 112)
However, startup time from standby mode will be longer.
- Timer Setting for Quick Start:
“Quick Start” is activated when the set time comes.



- When “Home Network function” (⇒ 99), “TV Anywhere” (⇒ 99) or “DVB-via-IP Server” (⇒ 100) is set to “On”, the setting for this function is fixed to “On”.
- If “Off” or “Timer Setting for Quick Start” is selected, the setting for “Front Panel Display” in “Display” is fixed to “Automatic”. (⇒ 96)

Automatic Standby

Set the time to turn the unit to standby mode automatically.

When the unit is not operating, the unit will be turned to standby mode once the set time has passed.

Automatic Standby after OTR

- On:
This unit is turned to standby mode when it is not operated for approximately 5 minutes after completing “Automatic Stop” or “Recording Time” (⇒ 35).

Automatic Standby after Copy

- On:
This unit is turned to standby mode when it is not operated for approximately 5 minutes after completing copy (⇒ 65, Copying from media other than HDD with Video Menu, ⇒ 66, Copying programmes with copying list).

UBC90

DVB-C RF OUT (CATV Signal)

DVB-T DVB-T2 RF OUT (Aerial Signal)

Set whether to output the broadcasting signal from RF OUT or not while in standby mode (When “Quick Start” is not activated).

- If “On” is selected, the broadcast signal is looped through by this unit and power consumption in standby exceeds 0.5 W slightly. (approx. 0.7 W)
- If “Off” is selected, the broadcast signal is not looped through by this unit and power consumption in standby becomes less than 0.5 W. (approx. 0.3 W)

Networked Standby

This unit can be turn on using a wake-up message sent from the network device in the home network. (Available only when “Quick Start” is set to “Off”.)

- On:
 - Power consumption increases when this unit is in standby mode. (⇒ 112)
 - This unit can be used as a DLNA Server when this unit is in standby mode. (This is possible if you have ever connected your client Panasonic recorder to the network using this unit as a server.)
- Off:
 - Power consumed when this unit is in standby mode becomes smaller than that consumed when “On” is selected. (⇒ 112)
 - When this unit is in standby mode, it cannot be used as a DLNA Server.
- When you change the “On”/“Off” setting of this function, the “On”/“Off” setting of “Home Network function” also changes.
- If “Quick Start” and “Home Network function” are set to “On”, even when this unit is turned off, it can be used as a DLNA Server.



- This function may not work correctly depending on network environment.

Remote Control

Change the remote control code on the main unit and the remote control if you place other Panasonic products close together.

- Use “Set Code 1”, the factory set code, under normal circumstances.
- 1 Select the code, then press [OK].
 - 2 While pressing [OK], press and hold the number button ([1] to [6]) for more than 5 seconds.
 - 3 Press and hold [OK] for more than 5 seconds.
 - 4 Press [OK].

Clock

If the time is not set correctly, use the settings listed in the method below.

- Automatic
This unit usually obtains time and date information from digital broadcasts.
- Time Zone
When the time is not correct, set “Time Zone”. (GMT – 6 to + 6)
- Manual Setting
 - 1 Select “Off” of “Automatic”, then press [OK].
 - 2 Select the item you want to change.
 - 3 Change the setting.
 - 4 Press [OK] when you have finished the settings.



- When the clock is set manually, you cannot perform playing/recording/PAUSE LIVE TV/REWIND LIVE TV of the programmes that are copy protected (Retention limit). (⇒ 10)

PIN Entry

You can set/change the PIN for parental control.

- 1 Enter your 4-digit PIN with the number buttons.
 - 2 Enter the new 4-digit PIN with the number buttons.
 - **Make a note of PIN in case you forget it.**
- e.g.,

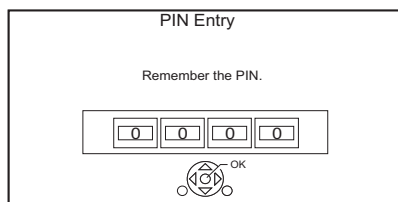

- 3 Press [OK].

System Update

Software Update in Standby

When you set this unit to standby mode, software (firmware) updates (⇒ 84) are downloaded automatically at the time you have specified.

Software Update Now (Broadcast)

Refer to “Software (Firmware) Update”. (⇒ 84)

Software Update Now (Internet)

Refer to “Software (Firmware) Update”. (⇒ 84)

Software Licence

Information about the software licence is displayed.

System Information

Display Software (firmware) version and Wireless Module version (When using wireless connection only) of this unit.

Initialize

Shipping Condition

All the settings except for some settings return to the factory preset.

- The timer recording programmes are also cancelled.
- The device password is also initialized. (⇒ 99)

Default Settings

All the settings other than the tuning settings, clock settings, language settings, rating PIN, remote control code, device password, etc. return to the factory presets.

Troubleshooting guide

Before requesting service, make the following checks. If the problem still persists, consult your dealer for instructions.

Updating to the latest software (firmware) may solve the problem. (⇒ 84)

The followings do not indicate a problem with this unit:

- Regular disc rotating sounds or HDD rotating sounds.
- Poor reception due to atmospheric conditions.
- When you switch the unit on or to standby mode, there may be an unexpected sound.

General operation

The unit does not work.

- Check the connections. (⇒ 11, 13)
- One of the unit's safety devices may have been activated.

Reset the unit as follows:

- 1 Press [⏻/|] on the main unit to switch the unit to standby.
 - If the unit does not switch to standby, press [⏻/|] on the main unit for about 3 seconds. The unit is forcibly switched to standby. Alternatively, disconnect the AC mains lead, wait one minute, then reconnect it.
- 2 Press [⏻/|] on the main unit to switch it on. If the unit still cannot be operated, consult the dealer.

Cannot eject a disc.

- 1 Press and hold [⏻/|] on the main unit for at least 3 seconds when it is turned off.
- 2 Press and hold [OK], the yellow button and the blue button at the same time for more than 5 seconds.
 - "00 RET" is displayed on the front panel display.
- 3 Repeatedly press [▶] (right) until "06 FTO" is displayed on the front panel display.
- 4 Press [OK].

The remote control does not work.

- The remote control and main unit are using different codes. Change the code on the remote control.



Front panel display

Press and hold [OK] and the indicated number button at the same time for more than 5 seconds. (⇒ 102)

Startup is slow.

- Startup takes time in the following situations:
 - A disc is inserted.
 - The clock is not set.
 - Immediately after a power failure or the AC mains lead is connected.
 - When a BD-J application is executing.
 - When the "Quick Start" is not activated. (⇒ 101)

Displays

"0:00" is flashing on the front panel display.

- Set the clock. (⇒ 102)

The clock does not display on the unit when switched to standby.

- The clock does not display when "Front Panel Display" is set to "Automatic". (⇒ 96)

Screen size is wrong.

- Adjust the aspect ratio setting on TV.
- Check “Aspect for Recording” before recording or picture quality change. (⇒ 93)

UBC90

TV reception is not displayed.

- Broadcast signals are not output from this unit's RF OUT terminal. Select “On” in “RF OUT (CATV Signal)” or “RF OUT (Aerial Signal)”. (⇒ 101)

The black screen appears on the TV.

- This phenomenon may occur, depending on the TV setting, when “Quick Start” is activated. Depending on the TV, this phenomenon may be prevented by reconnecting to a different HDMI input terminal.

The screen changes automatically.

- If “Screen Saver” is set to “On”, the screen saver function will be activated when there is no operation for 5 minutes or more. (⇒ 96)

There is a lot of image lag when playing video.

- Set to “0” all items in the “Noise Reduction”. (⇒ 58)
- Set “Audio Delay”. (⇒ 95)

The images do not appear on the TV.

The picture is distorted during play, or video is not played correctly.

- Check the connections. (⇒ 11, 13)
- Check the settings of the connected TV, etc.
- An incorrect resolution is selected in “Video Format”. (⇒ 96) Reset the setting as follows:
 - 1 While the unit is on, press and hold [OK], the yellow button and the blue button at the same time for more than 5 seconds.
 - “00 RET” is displayed on the front panel display.
 - 2 Repeatedly press [▶] (right) until “04 PRG” is displayed on the front panel display.
 - 3 Press and hold [OK] for at least 3 seconds. Set the item again.
 - When Dolby Digital Plus, Dolby TrueHD, and DTS-HD® audio are not output properly, select “Yes” in “Default Settings” and make proper settings. (⇒ 102)
- The connected TVs are changed. Reset the setting as follows:
 - 1 While the unit is on, press and hold [OK], the yellow button and the blue button on the remote control at the same time for more than 5 seconds.
 - “00 RET” is displayed on the front panel display.
 - 2 Repeatedly press [▶] (right) until “13 L4K” is displayed on the front panel display.
 - 3 Press and hold [OK] for at least 5 seconds. Set the item again.
 - “4K(50p/60p) Output” will be set to “Off”. Make the correct setting again. (⇒ 96)
- The unit's TV System is different from that of the disc. Change the TV System. (⇒ 96, TV System)
- The picture may be distorted or a black screen may appear between scenes recorded with different aspect ratios.
- Set “Deep Colour Output” (⇒ 97) or “Contents Type Flag” (⇒ 98) to “Off”.

UBC90

- **DVB-T** **DVB-T2** (Germany only) Check the broadcast system. If the broadcast system already has been switched over to DVB-T2, perform “Update Channel List” to update the channel list.

Video is not output.

- Video is not output when the “High Clarity Sound” is set to “On (Video Off)”. (⇒ 59)
- Video from the HDMI AUDIO OUT terminal is not output when the “HDMI(AUDIO) Output Mode” is set to “Audio Only”. (⇒ 97)

Video is not output in 4K or high-definition.

- Confirm that “Video Format” in the Setup menu is set properly. (⇒ 96)
- Confirm the HDMI cable, related connections and the compatibility of TV video input.
To output images in 4K, connect the HDMI cable to a 4K compatible terminal of the connected TV. (⇒ 11)
- Set “HDMI(AUDIO) Output Mode” to “Audio Only”. (⇒ 97)
- To enjoy image in 4K (50p/60p), set “4K(50p/60p) Output” to “4K(50p/60p) 4:4:4” or “4K(50p/60p) 4:2:0”. (⇒ 96)
- If “4K(50p/60p) Output” is set to “4K(50p/60p) 4:4:4”, check to see if the connected HDMI cable supports 18 Gbps. (⇒ 11, 96)
- If 4K images are not output from the connected 4K-compatible TV, set “4K(50p/60p) Output” to “4K(50p/60p) 4:4:4” or “4K(50p/60p) 4:2:0”. (⇒ 96)

Cannot output video in HDR quality (even when connected to an HDR-compatible TV).

- When connected to a TV or terminal that does not support HDR, this unit applies Dynamic Range Conversion to HDR signals to output them. In this case, “Dynamic Range Conversion Output” is displayed on the screen. (⇒ 53)
In addition, depending on the disc, it may not be possible to output content in 2K resolution or perform playback correctly. (⇒ 55)
- Video may not be output from your TV in HDR quality, depending on the content. Set “HDR (High Dynamic Range) Output” and “HLG / PQ Conversion” to “Automatic”. (⇒ 97)

3D video is not output correctly.

- 3D video may be output correctly by changing the following settings:
 - “Signal Format” (⇒ 56, 3D settings during playback)
- Check the settings of the connected TV.
- When a non-3D compatible amplifier/receiver is connected between this unit and a TV, 3D video is not output. (⇒ 16)
- When “Audio Output” is set to “Off”, 3D video may not be output correctly. (⇒ 97)

Cannot play back videos on the USB device smoothly.

- Use the port on the front side of this unit, which supports USB 3.0. You may be able to improve the performance.

Sound

No sound.

Distorted sound.

- Check the connections. (⇒ 11, 13)
- Check the settings of the connected TV, etc.
- Press [AUDIO] to select the audio. (⇒ 31, 54)
- To output audio from a device connected with an HDMI cable, set “Audio Output” to “On”. (⇒ 97)

Cannot change audio channel.

- You cannot change the audio channel if “Digital Audio Output” is set to “Bitstream” (⇒ 95)

Cannot hear the desired audio.

- Check the connections and the “Digital Audio Output” settings. (⇒ 14, 95)
- To output audio from a device connected with an HDMI cable, set “Audio Output” to “On” in the Setup menu. (⇒ 97)
- When connecting this unit to a TV via an HDMI VIDEO OUT and to an amplifier/receiver via an HDMI AUDIO OUT, set “HDMI(VIDEO) Output Mode” to “Automatic (Video Only / Video+Audio)”. (⇒ 14, 97)

There is no sound coming out.

- Refer to “Connection” (⇒ 11 - 18) to check the audio output settings suited to the connections of your device.

In the following cases, audio is not output from the terminals listed below:

• HDMI VIDEO OUT terminal

- When a device is connected to the HDMI AUDIO OUT terminal and “HDMI(VIDEO) Output Mode” is set to “Automatic (Video Only / Video+Audio)” (⇒ 97)
- When “Audio Output” in “Advanced Settings” is set to “Off” (⇒ 97)
- While playback is being performed with “Audio Output” in “Settings for High Clarity Sound” set to “COAXIAL Only” (⇒ 95)

• HDMI AUDIO OUT terminal

- When “Audio Output” in “Advanced Settings” is set to “Off” (⇒ 97)
- While playback is being performed with “Audio Output” in “Settings for High Clarity Sound” set to “COAXIAL Only” (⇒ 95)

• COAXIAL terminal

- When a device is connected to the HDMI AUDIO OUT terminal and “Audio Output” in “Advanced Settings” is set to “On” (⇒ 97)
- While playback is being performed with “Audio Output” in “Settings for High Clarity Sound” set to “HDMI Only” (⇒ 95)

Recording, timer recording and copying

Cannot record.

Cannot copy.

- Some broadcasts are copyright protected.
- You cannot record to the disc by pressing the [REC ●] or timer recording.
- The disc is protected. (⇒ 85)
- **DVD-R** **DVD-RW** **+R** **+RW** Since it will copy to HDD temporarily, copying is not possible if there is insufficient available capacity on the HDD.
- This unit cannot record/copy NTSC signals to discs that already have PAL signal recordings.

A part or whole of a recorded programme has been lost.

If there is a power failure or the AC mains lead is disconnected from the household mains socket while recording or editing, the programme may be lost or the HDD may become unusable. We cannot offer any guarantee regarding lost programmes.

Timer recording does not work properly.

- When  is displayed on the screen. (⇒ 43)
- If your CAM requires a PIN for timer recording, you need to enter PIN in advance. (⇒ 93, PIN Entry for Decrypt Recording)

Auto Renewal Recording does not work properly.

- The programme will not be overwritten in the following cases:
 - the programme is protected
 - any programme is being played back or copied
 - a screen such as Video Menu is displayedInstead, the programme will be saved as a separate programme and that will be overwritten.

An unusually loud sound is coming from the rotating disc.

- If you want copy to perform more quietly, select "Normal (Silent)" in "Disc Speed for Copy". (⇒ 93)

The time recorded on the disc and the available time shown do not add up.

- **DVD-R** **+R** If you record or edit many times, the remaining capacity is reduced and then recording or editing may be disabled.
- Available disc space display may be different from actual.

Encrypted programmes cannot be decrypted.

- Depending on the encrypted service, it may not be possible to decrypt certain content.

Keyword Recording does not work properly.

- The Keyword Recording function can search the First 250 channels listed on "All DVB Channels" or the First 50 channels registered for "Favourites1". (⇒ 88, 91)
- The unit may not record a Keyword Recording programme when part of its broadcast time overlaps with that of another timer-recording programme. When this occurs, the Keyword Recording does not start even after the timer-recording has finished.
- When "Search Channel" is set to "First 50 Favourites1", the unit does not search for programmes unless you register channels to "Favourites1".

Play

Cannot play back.

- The disc is dirty. (⇒ 28)
- The disc is scratched or marked.
- The disc may not be able to play back if it was not finalised or a Top Menu was not created on the equipment used for recording.
- Refer to "Screen icons". (⇒ 48)
- Depending on the encrypted service, it may not be possible to play back certain programmes if they have been recorded without being decrypted.
- Depending on the Ultra HD Blu-ray disc, it may not be possible to perform playback unless this unit is connected to the Internet.

Audio and video momentarily pause.

- DVD-R DL and +R DL discs have two writable layers on one side. Video and audio may momentarily cut out when the unit is switching layers.

You have forgotten your rating PIN.

- The rating level returns to the factory preset.
 - 1 While the unit is on, press and hold [OK], the yellow button and the blue button at the same time for more than 5 seconds.
 - "00 RET" is displayed on the front panel display.
 - 2 Repeatedly press [▶] (right) until "03 VL" is displayed on the front panel display.
 - 3 Press [OK].
 - "Init" is displayed on the front panel display.

Image for the Quick View is not smooth.

- Image may not be played back smoothly in case of high definition contents.

Cannot play the disc on other players.

- Refer to "Play on other players". (⇒ 28)

Edit

Cannot edit.

- You may not be able to edit on the HDD if there is no available space. Delete any unwanted programmes to create empty space. (⇒ 60)

Photo

The contents of the SD card cannot be read.

- Remove the card from the slot and then insert again. If this does not solve the problem, switch the unit to standby mode and turn it on again.

Photos do not play back normally.

- The images that were edited on the PC, such as Progressive JPEG, etc., may not play back. (⇒ 26)

USB

This unit does not recognize the USB device correctly.

- If inserted during playback the USB device may not be recognized by this unit. Disconnect and reconnect the USB device. If it still does not recognize the connection, switch the unit to standby mode and turn it on again.
- USB devices connected using a USB extension cable other than a dedicated one or a USB hub may not be recognized by this unit.
- Two USB devices cannot be used simultaneously. If you insert a USB device while watching TV, the USB device detection screen is displayed. Use this screen to select the device you want to use.

TV Guide

The TV Guide information is not displayed properly.

- Set the clock correctly. (⇒ 102, Clock)
- There was a programme change, or TV Guide information from a broadcast station was possibly not correctly transmitted.
- If signal quality is bad, the TV Guide system may not be able to receive any data.
- It may take time until the TV Guide screen is displayed correctly. Wait for about a day.

Broadcast

Picture regularly breaks up on some channels.

- Adjust the reception with "Manual Tuning". (⇒ 89, 91)

The channel which was once selectable cannot be selected.

- Reveal the channel on the channel list. (⇒ 89, 91)

Digital broadcasts cannot be received.

- To receive an encrypted broadcast, a CI module valid for the broadcast is required.

UBS90

- The dish may not be pointing in the direction of the satellite. If problem persists consult your local TV aerial installer.
- When you use only one terminal, you may not view correctly if you connect the satellite cable to the LNB IN 2 terminal.
- A wrong single cable version is set. Perform Easy Setting again. (⇒ 22)

UBC90

Major channels and favourite channels are not displayed on the top part of the channel list.

- **DVB-C** To change channel allocation, restart Auto Setup in Basic Settings menu and change channel number allocation selection. (⇒ 89)
- You can change channel number assignment. (⇒ 89)

UBC90 DVB-T DVB-T2

UBS90

Picture very infrequently breaks up on some or all channels.

- Electrical atmospheric interference caused by bad weather may cause pictures to break up and audio to mute or distort momentarily.

You cannot access this unit from DLNA compatible equipment on the network.

- Check the network connection and the network settings. (⇒ 19, 22)
- It may not be possible to connect depending on the types of the equipment or the status of the equipment.

When using this unit as a server, video frames are dropped.

- Change the following settings:
 - Conversion Setting for DLNA (⇒ 99)
 - Resolution Setting for DLNA (⇒ 100)
- The unit cannot be used as a server while you are watching or playing back a 4K programme, for example.

You cannot play contents properly from DLNA compatible equipment on the network.

- There may be some video that cannot be played back on DLNA compatible equipment depending on the equipment.
- Following programmes may not be played back:
 - A programme with access restriction
 - A programme with contents protection (⇒ 10)
 - A programme with incompatible format
 - An encrypted programme (🔒)
- Playback via DLNA compatible equipment may not be performed when this unit is in the following conditions:
 - While playing back a BD-Video
 - While simultaneously performing Copy (Keep Picture Quality) and recording
 - While displaying the Basic Settings menu
 - While executing functions using a network, such as Network Service
- If the DLNA compatible equipment is not capable of outputting HE-AAC audio format, etc., sound may not be played back.
- When “Automatic” is set for “Audio Description” (⇒ 32), some parts of Home Network function cannot be used.
Set “Audio Description” to “Off”.

When using Wireless LAN connection, video from the DLNA Certified media server is not played back or video frames are dropped during playback.

- Use 802.11n (2.4 GHz or 5 GHz) Wireless router.
Simultaneous use with a microwave, cordless telephone etc. at 2.4 GHz may result in connection interruptions or other problems.
- On the “Wireless Settings” screen (⇒ 98), the continuous lighting of at least four “Reception” indicators is the target for a stable connection. If three or fewer indicators are lit or the connection is being interrupted, change the position or angle of your Wireless router. If there is no improvement, connect to a wired network and perform the “Easy Network Setting” (⇒ 22, 98) again.

When using this unit’s DVB-via-IP Server function, the broadcast being watched on the DVB-via-IP Client device or being recorded with it is interrupted.

- If you use a network function other than the DVB-via-IP Server function when “Network Function Priority” for this unit is set to “Network Service / Home Network”, the broadcast you are watching on the DVB-via-IP Client device or recording with it will be interrupted. Change the “Network Function Priority” setting for this unit to “DVB-via-IP Server”. (⇒ 100)

Reset

To return all the settings to the factory preset Perform “Shipping Condition” or “Default Settings”. (⇒ 102)

Messages on the front panel display

The following messages or service numbers appear on the front panel display when something unusual is detected.

CAM UPGRADE

CAM is being updated. (⇒ 84)

CONVERSION

The picture quality of the selected programme stored in the USB HDD is being changed.

Do not disconnect the USB HDD from this unit.

GUIDE

TV Guide data is being downloaded.

NO ERASE

You cannot delete items on this disc.

The disc may be damaged.

NO READ

- The disc is dirty. (⇒ 28) The unit cannot record, play, or edit.
- The lens cleaner has finished cleaning. Press [▲ OPEN/CLOSE] on the main unit to eject the disc.

PLEASE WAIT.

- Displayed when the unit is started and is switched to standby mode.
- There was a power failure or the AC plug was disconnected while the unit was on. The unit is carrying out its recovery process. Wait until the message disappears.

PROGRAMME FULL

- There are already 32 timer programmes. Delete unnecessary timer programmes. (⇒ 43)
- You are trying to divide a programme when the maximum possible number of programmes is already stored on the media.

REMOVE

The USB device is drawing too much power.

Remove the USB device.

SET CODE □

("□" stands for a number.)

The remote control and main unit are using different codes. Change the code on the remote control. (⇒ 103)

START

Update of the software (firmware) is started.

You cannot operate the unit until the update is complete. (⇒ 84)

SW-DL

Software (firmware) is downloading.

Download will stop when the unit is turned on, or the timer recording starts. (⇒ 84)

UNSUPPORT

The media is not supported.

UPDATE □/□

("□" stands for a number.)

The software (firmware) is being updated.

You cannot operate the unit until the update is complete. (⇒ 84)

U50

An error has occurred in the antenna's power supply. Check to see if the antenna's cable core and braided wire shield are in contact with each other.

U59

The unit is hot.
The unit switches to standby for safety reasons.
Wait for about 30 minutes until the message disappears.
Install or place this unit with good ventilation.

U61

(When a disc is not inserted) A malfunction has occurred. The unit is trying to restore to the normal operation. Once the message disappears you can use the unit again.
If it remains displayed, consult the dealer.

U76

HDMI cannot be output because it is connected to a model that does not support copyright protection.

U77

Due to the current disc not having authorised copyright information, video output is not performed.

U88

(When a disc is inserted) There was something unusual detected with the disc or the unit. The unit is trying to restore to the normal operation. Once the message disappears you can use the unit again.
If it remains displayed, consult the dealer.

U99

The unit fails to operate properly. Press [⏻/I] on the main unit to switch the unit to standby mode. Now press [⏻/I] on the main unit again to turn the unit on.

X HOLD

The HOLD function is activated. (⇒ 87)

Specifications

Specifications are subject to change without notice.

■ General

Dimensions: 430 mm (W)
68 mm (H)
(including the projecting parts)
210 mm (D)

Mass: Approx. 3.3 kg

Power supply: AC 220 V to 240 V, 50 Hz

Power consumption:

UBC90 Approx. 48 W
UBS90 Approx. 68 W

Power consumption in networked standby mode:

“Quick Start” is not activated and “Networked Standby” is set to “On”

Approx. 2 W

Power consumption in standby mode:

UBC90
“Quick Start” is not activated,
“Networked Standby” is set to “Off” and
“RF OUT (CATV Signal)” or “RF OUT
(Aerial Signal)” is set to “Off”

Approx. 0.3 W

UBS90
“Quick Start” is not activated and “Networked Standby” is set to “Off”

Approx. 0.3 W

Operating temperature: 5 °C to 40 °C

Operating humidity range: 10 % to 80 % RH
(no condensation)

■ Output terminal

Digital Audio out (coaxial): 1 pc.

HDMI out (19 pin type A): 2 pcs.

■ Internal HDD capacity

2 TB

■ TV system

UBC90
Tuner System: DVB-C/DVB-T/DVB-T2

Country: Germany, Austria, Switzerland

Channel coverage: VHF: 5 - 12
UHF: 21 - 69
CATV:S1 - S20 (M1 - U10) 7 MHz Band
D051 - D073
D113 - D858

UBS90
Tuner System: DVB-S/DVB-S2

Antenna receive frequency: 950 MHz to 2150 MHz

Input impedance: Nominal 75 Ω

Demodulation: QPSK, 8PSK

LNB input: F shape terminal female,
power supply 13 V/18 V max. 400 mA

DiSEqC: Version 1.0 or Tone burst A/B,
22 kHz 0.65 Vp-p

■ Other terminals

USB Port (Type A)
Front: 1 pc., DC 5V, Max. 900 mA
[Super-Speed USB (USB 3.0)]
Rear: 1 pc., DC 5V, Max. 500 mA
[High-Speed USB (USB 2.0)]

SD Card Slot: 1 pc.

Common Interface slot: 2 pcs.

LAN (Ethernet) Port: 1 pc.
10BASE-T/100BASE-TX

■ Wireless LAN

Standard compliance: IEEE802.11a/b/g/n

Frequency range: 2.4 GHz/5 GHz band

Security*:
WPA™/WPA2™
(Encryption type: TKIP/AES,
Authentication type: PSK)
WEP (64 bit/128 bit)

* This unit supports WPA™ and WPA2™ encryption.

■ LASER specification

Class 1 LASER Product

Wave length: 405 nm (BDs)
661 nm (DVDs)
783 nm (CDs)

Laser power:

No hazardous radiation is emitted with the safety protection

Recording modes (picture quality) and approximate recording times

Depending on the content being recorded, the recording time may become shorter than indicated.

■ DR mode

| Recording Mode (picture quality) | HDD | BD-RE, BD-R | |
|--|-----------|----------------------|--------------------|
| | (2 TB) | Single Layer (25 GB) | Dual Layer (50 GB) |
| DR (UHD quality) | 151 hours | ※1 | ※1 |
| DR (HD quality) | 303 hours | 3 hours 30 min. | 7 hours 30 min. |
|  DR (HEVC quality) | 847 hours | 10 hours 15 min. | 21 hours |
| DR (SD quality) | 847 hours | 10 hours 15 min. | 21 hours |

※1 It is not possible to copy UHD programmes to Blu-ray discs while maintaining their original picture quality.

• Recording time of DR mode may vary depending on the bit rate of broadcasting:

- UHD quality: estimated bit rate is 28 Mbps
- High Definition (HD) quality: estimated bit rate is 14 Mbps
- HEVC/Standard Definition (SD) quality: estimated bit rate is 5 Mbps

■ HG, HX, HE, HL, HM modes

| Recording Mode (picture quality) | HDD | BD-RE, BD-R | |
|----------------------------------|------------|----------------------|--------------------|
| | (2 TB) | Single Layer (25 GB) | Dual Layer (50 GB) |
| HG | 315 hours | 4 hours | 8 hours |
| HX | 471 hours | 6 hours | 12 hours |
| HE | 707 hours | 9 hours | 18 hours |
| HL | 946 hours | 12 hours | 24 hours |
| HM | 1370 hours | 17 hours 30 min. | 35 hours |

■ XP, SP, LP modes

| Recording Mode (picture quality) | HDD | BD-RE, BD-R | |
|----------------------------------|------------|----------------------|--------------------|
| | (2 TB) | Single Layer (25 GB) | Dual Layer (50 GB) |
| XP | 431 hours | ※2 | ※2 |
| SP | 863 hours | ※2 | ※2 |
| LP | 1726 hours | ※2 | ※2 |

※2 It is not possible to copy programmes recorded in XP/SP/LP mode to Blu-ray discs while maintaining their original picture quality.

| Recording Mode (picture quality) | DVD-RAM | | DVD-R, +R, +RW (4.7 GB) | DVD-R DL, +R DL (8.5 GB) |
|----------------------------------|-----------------------|-----------------------|-------------------------|--------------------------|
| | Single-sided (4.7 GB) | Double-sided (9.4 GB) | | |
| XP | 1 hour | 2 hours | 1 hour | 1 hour 45 min. |
| SP | 2 hours | 4 hours | 2 hours | 3 hours 35 min. |
| LP | 4 hours | 8 hours | 4 hours | 7 hours 10 min. |

• Regarding recording time remaining:

This unit records using a VBR (Variable bit rate) data compression system to vary recorded data segments to match video data segments which may cause differences in the displayed amount of time and space remaining for recording.

Audio information

The audio output differs depending on which terminals are connected to the amplifier/receiver, and the setting on this unit. (⇒ 95, Digital Audio Output)

- The number of channels listed is the maximum possible number of output channels when connected to amplifier/receiver compatible with the respective audio format.

| Terminal | Digital Audio Output | |
|--------------------------|--|--|
| | Bitstream | PCM |
| HDMI AV OUT | Output using original audio ^{*1} | BD-Video: 7.1ch PCM ^{*1, 2} DVD-Video: 5.1ch PCM |
| DIGITAL AUDIO OUT | Dolby Digital/ DTS Digital Surround™ | Down-mixed 2ch PCM |

^{*1} When “BD-Video Secondary Audio” is set to “On”, the audio will be output as Dolby Digital, DTS Digital Surround™ or 5.1ch PCM.

^{*2} The audio output is amplified from 5.1ch or 6.1ch to 7.1ch depending on the DTS, Inc. specifications.

Language code list

| | | | |
|-------------------|------|-----------------|------|
| Abkhazian: | 6566 | Lingala: | 7678 |
| Afar: | 6565 | Lithuanian: | 7684 |
| Afrikaans: | 6570 | Macedonian: | 7775 |
| Albanian: | 8381 | Malagasy: | 7771 |
| Amharic: | 6577 | Malay: | 7783 |
| Arabic: | 6582 | Malayalam: | 7776 |
| Armenian: | 7289 | Maltese: | 7784 |
| Assamese: | 6583 | Maori: | 7773 |
| Aymara: | 6589 | Marathi: | 7782 |
| Azerbaijani: | 6590 | Moldavian: | 7779 |
| Bashkir: | 6665 | Mongolian: | 7778 |
| Basque: | 6985 | Nauru: | 7865 |
| Bengali; Bangla: | 6678 | Nepali: | 7869 |
| Bhutani: | 6890 | Norwegian: | 7879 |
| Bihari: | 6672 | Oriya: | 7982 |
| Breton: | 6682 | Pashto, Pushto: | 8083 |
| Bulgarian: | 6671 | Persian: | 7065 |
| Burmese: | 7789 | Polish: | 8076 |
| Byelorussian: | 6669 | Portuguese: | 8084 |
| Cambodian: | 7577 | Punjabi: | 8065 |
| Catalan: | 6765 | Quechua: | 8185 |
| Chinese: | 9072 | Rhaeto-Romance: | 8277 |
| Corsican: | 6779 | Romanian: | 8279 |
| Croatian: | 7282 | Russian: | 8285 |
| Czech: | 6783 | Samoan: | 8377 |
| Danish: | 6865 | Sanskrit: | 8365 |
| Dutch: | 7876 | Scots Gaelic: | 7168 |
| English: | 6978 | Serbian: | 8382 |
| Esperanto: | 6979 | Serbo-Croatian: | 8372 |
| Estonian: | 6984 | Shona: | 8378 |
| Faroese: | 7079 | Sindhi: | 8368 |
| Fiji: | 7074 | Singhalese: | 8373 |
| Finnish: | 7073 | Slovak: | 8375 |
| French: | 7082 | Slovenian: | 8376 |
| Frisian: | 7089 | Somali: | 8379 |
| Galician: | 7176 | Spanish: | 6983 |
| Georgian: | 7565 | Sundanese: | 8385 |
| German: | 6869 | Swahili: | 8387 |
| Greek: | 6976 | Swedish: | 8386 |
| Greenlandic: | 7576 | Tagalog: | 8476 |
| Guarani: | 7178 | Tajik: | 8471 |
| Gujarati: | 7185 | Tamil: | 8465 |
| Hausa: | 7265 | Tatar: | 8484 |
| Hebrew: | 7387 | Telugu: | 8469 |
| Hindi: | 7273 | Thai: | 8472 |
| Hungarian: | 7285 | Tibetan: | 6679 |
| Icelandic: | 7383 | Tigrinya: | 8473 |
| Indonesian: | 7378 | Tonga: | 8479 |
| Interlingua: | 7365 | Turkish: | 8482 |
| Irish: | 7165 | Turkmen: | 8475 |
| Italian: | 7384 | Twi: | 8487 |
| Japanese: | 7465 | Ukrainian: | 8575 |
| Javanese: | 7487 | Urdu: | 8582 |
| Kannada: | 7578 | Uzbek: | 8590 |
| Kashmiri: | 7583 | Vietnamese: | 8673 |
| Kazakh: | 7575 | Volapük: | 8679 |
| Kirghiz: | 7589 | Welsh: | 6789 |
| Korean: | 7579 | Wolof: | 8779 |
| Kurdish: | 7585 | Xhosa: | 8872 |
| Laotian: | 7679 | Yiddish: | 7473 |
| Latin: | 7665 | Yoruba: | 8979 |
| Latvian, Lettish: | 7686 | Zulu: | 9085 |

Disclaimer

The recording and playback of content on this or any other device may require permission from the owner of the copyright or other such rights in that content. Panasonic has no authority to and does not grant you that permission and explicitly disclaims any right, ability or intention to obtain such permission on your behalf. It is your responsibility to ensure that your use of this or any other device complies with applicable copyright legislation in your country. Please refer to that legislation for more information on the relevant laws and regulations involved or contact the owner of the rights in the content you wish to record or playback.

Personal information handling

To provide functions and services of this unit, a device ID, device password and usage history information are stored and managed securely in an appropriate security environment of Panasonic.

Please note that usage history and other information may be collected for purposes such as improving products and services in such a way that individuals cannot be identified.

Indemnity concerning recorded content

Panasonic does not accept any responsibility for damages directly or indirectly due to any type of problems that result in loss of recording or edited content (data), and does not guarantee any content if recording or editing does not work properly. Likewise, the above also applies in a case where any type of repair is made to the unit (including any other non-HDD related component).

About data service (Catch Up TV)

- On-screen instructions may not correspond to the remote control buttons.
- It may take some time to show the data service.
- Some functions of the data service may be deactivated during recording.





About Network Service

- Some features of websites or content of the service may not be available.
- If using slow Internet connection, the video may not be displayed correctly. A high-speed Internet service with a speed of at least 6 Mbps is recommended.
- The services through Network Service are operated by their respective service providers, and service may be discontinued either temporarily or permanently without notice. Therefore, Panasonic will make no warranty for the content or the continuity of the services.
- A separate subscription is required to watch Netflix.

About TV Anywhere

- Please note that a regular maintenance or unexpected trouble may interrupt the service, and that the service content may be changed or revoked and operation menu screens may be changed with or without a prior notice.
- We recommend that you use a high-speed connection, such as LTE or Wi-Fi.
- TV Anywhere services may be discontinued temporarily or permanently without notice.

Licenses

| |
|---|
| <p>"AVCHD", "AVCHD 3D", "AVCHD Progressive" and "AVCHD 3D/Progressive" are trademarks of Panasonic Corporation and Sony Corporation.</p> |
| <p>Copyright 2004-2014 Verance Corporation. Cinavia™ is a Verance Corporation trademark. Protected by U.S. Patent 7,369,677 and worldwide patents issued and pending under license from Verance Corporation. All rights reserved.</p> |
| <p>DLNA, the DLNA Logo and DLNA CERTIFIED are trademarks, service marks, or certification marks of the Digital Living Network Alliance.</p> |
| <p>DVB and the DVB logos are trademarks of the DVB Project.</p> |
| <p>DiSEqC™ is a trademark of EUTELSAT.</p> |
| <p>The "CI Plus" Logo is a trademark of CI Plus LLP.</p> |
| <p>Dolby, Dolby Audio, and the double-D symbol are trademarks of Dolby Laboratories.</p> <div data-bbox="882 363 949 443" style="text-align: right;">  </div> |
| <p>For DTS patents, see http://patents.dts.com. Manufactured under license from DTS Licensing Limited. DTS, DTS-HD, the Symbol, & DTS and the Symbol together are registered trademarks, and DTS-HD Master Audio Essential is a trademark of DTS, Inc. © DTS, Inc. All Rights Reserved.</p> <div data-bbox="797 507 1010 561" style="text-align: right;">  </div> |
| <p>"DVD Logo" is a trademark of DVD Format/Logo Licensing Corporation.</p> |
| <p>MPEG Layer-3 audio coding technology licensed from Fraunhofer IIS and Thomson.</p> |
| <p>This product is licensed under the AVC patent portfolio license for the personal use of a consumer or other uses in which it does not receive remuneration to (i) encode video in compliance with the AVC Standard ("AVC Video") and/or (ii) decode AVC Video that was encoded by a consumer engaged in a personal activity and/or was obtained from a video provider licensed to provide AVC Video. No license is granted or shall be implied for any other use. Additional information may be obtained from MPEG LA, L.L.C. See http://www.mpegla.com</p> |
| <p>This product is licensed under the VC-1 patent portfolio license for the personal and non-commercial use of a consumer to (i) encode video in compliance with the VC-1 Standard ("VC-1 Video") and/or (ii) decode VC-1 Video that was encoded by a consumer engaged in a personal and non-commercial activity and/or was obtained from a video provider licensed to provide VC-1 video. No license is granted or shall be implied for any other use. Additional information may be obtained from MPEG LA, L.L.C. See http://www.mpegla.com</p> |
| <p>SDXC Logo is a trademark of SD-3C, LLC.</p> |
| <p>The Wi-Fi CERTIFIED™ Logo is a certification mark of Wi-Fi Alliance®. The Wi-Fi Protected Setup™ Logo is a certification mark of Wi-Fi Alliance®.</p> <div data-bbox="786 954 1021 1050" style="text-align: right;">  </div> |
| <p>"Wi-Fi®", "Miracast®", and "Wi-Fi Direct®" are registered trademarks of Wi-Fi Alliance®. "Wi-Fi Protected Setup™", "WPA™", and "WPA2™" are trademarks of Wi-Fi Alliance®.</p> |
| <p>The terms HDMI and HDMI High-Definition Multimedia Interface, and the HDMI Logo are trademarks or registered trademarks of HDMI Licensing, LLC in the United States and other countries.</p> |
| <p>Java is a registered trademark of Oracle and/or its affiliates.</p> <div data-bbox="882 1216 965 1375" style="text-align: right;">  </div> |
| <p>Windows is a trademark or a registered trademark of Microsoft Corporation in the United States and other countries.</p> |
| <p>Android is a trademark of Google Inc.</p> |

This product incorporates the following software:

- (1) the software developed independently by or for Panasonic Corporation,
- (2) the software owned by third party and licensed to Panasonic Corporation,
- (3) the software licensed under the GNU General Public License, Version 2.0 (GPL V2.0),
- (4) the software licensed under the GNU LESSER General Public License, Version 2.1 (LGPL V2.1), and/or
- (5) open source software other than the software licensed under the GPL V2.0 and/or LGPL V2.1.

The software categorized as (3) - (5) are distributed in the hope that it will be useful, but WITHOUT ANY WARRANTY, without even the implied warranty of MERCHANTABILITY or FITNESS FOR A PARTICULAR PURPOSE. Please refer to the detailed terms and conditions thereof shown in the Basic Settings menu.

At least three (3) years from delivery of this product, Panasonic will give to any third party who contacts us at the contact information provided below, for a charge no more than our cost of physically performing source code distribution, a complete machine-readable copy of the corresponding source code covered under GPL V2.0, LGPL V2.1 or the other licenses with the obligation to do so, as well as the respective copyright notice thereof.

Contact Information: oss-cd-request@gg.jp.panasonic.com

The source code and the copyright notice are also available for free in our website below.

<http://panasonic.net/avc/oss/>

MS/PlayReady/Final Product Labeling

This product contains technology subject to certain intellectual property rights of Microsoft. Use or distribution of this technology outside of this product is prohibited without the appropriate license(s) from Microsoft.

MS/PlayReady/End User Notices

Content owners use Microsoft PlayReady™ content access technology to protect their intellectual property, including copyrighted content. This device uses PlayReady technology to access PlayReady-protected content and/or WMDRM-protected content. If the device fails to properly enforce restrictions on content usage, content owners may require Microsoft to revoke the device's ability to consume PlayReady-protected content.

Revocation should not affect unprotected content or content protected by other content access technologies. Content owners may require you to upgrade PlayReady to access their content. If you decline an upgrade, you will not be able to access content that requires the upgrade.

Vorbis, FLAC, WPA Supplicant

The software licenses are displayed when "Software Licence" in the Basic Settings menu is selected. (⇒ 102)

Restriction on use of unauthorized copied content

This unit adopts the following technology for copyright protection.

Cinavia Notice

This product uses Cinavia technology to limit the use of unauthorized copies of some commercially-produced film and videos and their soundtracks. When a prohibited use of an unauthorized copy is detected, a message will be displayed and playback or copying will be interrupted. More information about Cinavia technology is provided at the Cinavia Online Consumer Information Center at <http://www.cinavia.com>. To request additional information about Cinavia by mail, send a postcard with your mailing address to:

Cinavia Consumer Information Center, P.O.

Box 86851, San Diego, CA, 92138, USA.

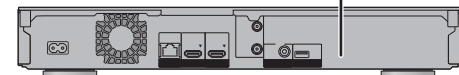

| | |
|------------------|--|
| DANGER | - VISIBLE AND INVISIBLE LASER RADIATION WHEN OPEN. AVOID DIRECT EXPOSURE TO BEAM. FDA21 CFR/CLASS IIIb |
| CAUTION | - CLASS 3B VISIBLE AND INVISIBLE LASER RADIATION WHEN OPEN. AVOID EXPOSURE TO THE BEAM. IEC60825-1/CLASS 3B |
| ATTENTION | - RAYONNEMENT LASER VISIBLE ET INVISIBLE CLASSE 3B. EN CAS D'OUVERTURE, ÉVITER UNE EXPOSITION AU FAISCEAU. |
| FORSIGTIG | - SYNLIG OG USYNLIG LASERSTRÅLING KLASSE 3B. NÅR LÅGET ER ÅBENT, UNDGÅ AT BLIVE UDSAT FOR STRÅLEN. |
| VARO | - AVATTAESSA OLET ALLTIINA LUOKAN 3B NÄKYVÄÄ JA NÄKYMÄTÖNTÄ LASERSÄTEILYÄ. VÄRÖ ALTIISTUMISTA SÄTEELLE. |
| VARNING | - KLASS 3B SYNLIG OCH OSYNLIG LASERSTRÅLNING NÄR DENNA DEL ÄR ÖPPNAD. UNDIK EXPONERING FÖR STRÅLEN. |
| VORSICHT | - SICHTBARE UND UNSICHTBARE LASERSTRAHLUNG KLASSE 3B. WENN ABDECKUNG GEÖFFNET, NICHT DEM STRAHL AUSSETZEN. |
| 注意 | - 打开时有可见及不可见激光辐射。避免光束照射。 |
| 注意 | - ここを覗くとクラス3Bの可視及び不可視レーザー放射が出る。ビームの目又は皮膚への照射は危険！見たり触れたりしないこと。 VQL2Q40 |

(Inside of product)

Index

| | |
|---------------------------------|----------------|
| A | |
| Audio | 31, 54, 114 |
| Audio Description | 32, 54 |
| Auto Setup | 20, 21, 89, 91 |
| AVCHD | 47, 51, 70, 82 |
| B | |
| Basic Settings | 88 |
| BD-Video | 51 |
| C | |
| CAM (Conditional Access Module) | 9, 84 |
| Channel information | 31 |
| Channel List | 33, 89, 91 |
| Chapter | 50, 63, 93 |
| Child Lock | 90 |
| Parental Control | 92 |
| HOLD function | 87 |
| CI Plus | 9, 84 |
| Clock | 102 |
| Common Interface | 9, 98 |
| Connection | |
| Antenna | 12, 13 |
| Network | 19 |
| Copy | 64 |
| AVCHD | 70, 82 |
| D | |
| Delete | |
| Music | 75, 94 |
| Photo | 73, 94 |
| Video | 60, 85, 93 |
| Delete BD-Video data | 52 |
| Disc | |
| Finalise | 86 |
| Format | 86 |
| Media information | 24 |
| Protection | 85 |
| DVB-via-IP Server | 100 |
| DVD-Video | 51 |
| E | |
| Easy setting | 20, 21 |
| Entering text | 87 |
| F | |
| Favourites | 88, 91 |
| Finalise | 86 |
| Format | |
| Disc | 86 |
| HDD | 94 |
| SD Card | 86 |
| USB HDD | 94 |
| freenet TV | 9 |
| FUNCTION MENU | 29 |
| H | |
| HDD | |
| Format | 94 |
| Media information | 24 |
| HDR | 14, 97 |
| Home Networking (DLNA) | 78, 99 |
| Client | 79 |
| Media Renderer | 80 |
| Server | 78 |
| K | |
| Keyword Recording | 43, 50 |
| L | |
| Language code list | 114 |
| Lens cleaner | 5 |
| M | |
| Manual Tuning | 89, 91 |
| Media Renderer | 80 |
| Miracast® | 81 |
| MKV | 51 |
| MP4 | 51 |
| Music | 74 |
| N | |
| Network | |
| Connection | 19 |
| Easy Network Setting | 22, 98 |
| Home Networking (DLNA) | 78, 99 |
| Miracast® | 81 |
| Network Service | 76 |
| Wi-Fi Direct® | 80 |

| | |
|---|----------------|
| P | |
| PAUSE LIVE TV | 34 |
| Photo | 71 |
| Picture Quality | 27, 61, 113 |
| PIN | 32, 102 |
| Playback menu | 57 |
| Protection | |
| Disc | 85 |
| Photo | 73 |
| Video | 60 |
| Pure Sound Mode | 93 |
| Q | |
| Quick Start | 101 |
| R | |
| Recording | 35 |
| Timer recording | 39 |
| Recording mode | |
| (picture quality) | 27, 61, 113 |
| Recording time | 113 |
| Remote control | 8 |
| HOLD function | 87 |
| Remote control code | 102 |
| TV operation | 19 |
| Reset | 102, 107, 109 |
| REWIND LIVE TV | 34, 93 |
| S | |
| SD Card | |
| Format | 86 |
| Media information | 24, 28 |
| miniSD / microSD | 28 |
| Setting | |
| Auto Setup | 20, 21, 89, 91 |
| Easy setting | 20, 21 |
| Slideshow | 72 |
| Software (Firmware) Update | 84 |
| T | |
| Timer recording | 39 |
| Top Menu | 87 |
| Create Top Menu | 87 |
| Troubleshooting guide | 103 |
| Messages | 110 |
| Tuning | |
| Channel List | 89, 91 |
| Child Lock | 90 |
| Manual Tuning | 89, 91 |
| Signal condition | 90, 92 |
| TV Anywhere | 76 |
| TV Guide | |
| Operation | 33 |
| Timer recording | 39 |
| TV System | 96 |
| TV>IP | 100 |
| U | |
| Ultra HD Blu-ray | 51, 55 |
| USB HDD (External HDD) | |
| Cancellation of all USB HDD Registrations | 94 |
| Disconnection | 46, 94 |
| Format | 94 |
| Media information | 24, 27 |
| Registration | 46, 94 |
| USB memories | |
| Media information | 24, 27 |
| V | |
| Video | |
| AVCHD | 47, 51 |
| BD-Video | 51 |
| Copy | 64 |
| Delete | 60 |
| DVD-Video | 51 |
| MKV | 51 |
| Playback | 47, 51 |
| Playlist created on other equipment | 51 |
| Recording | 35 |
| Ultra HD Blu-ray | 51, 55 |
| Video Menu | 47 |
| W | |
| Wi-Fi Direct® | 80 |
| 4K | 2 |
| 4K Networking | 57 |

Disposal of Old Equipment and Batteries**Only for European Union and countries with recycling systems**

These symbols on the products, packaging, and/or accompanying documents mean that used electrical and electronic products and batteries must not be mixed with general household waste.
 For proper treatment, recovery and recycling of old products and used batteries, please take them to applicable collection points in accordance with your national legislation.
 By disposing of them correctly, you will help to save valuable resources and prevent any potential negative effects on human health and the environment.
 For more information about collection and recycling, please contact your local municipality.
 Penalties may be applicable for incorrect disposal of this waste, in accordance with national legislation.

**Note for the battery symbol (bottom symbol):**

This symbol might be used in combination with a chemical symbol. In this case it complies with the requirement set by the Directive for the chemical involved.

**Declaration of Conformity (DoC)**

Hereby, "*Panasonic Corporation*" declares that this product is in compliance with the essential requirements and other relevant provisions of Directive 1999/5/EC.

Customers can download a copy of the original DoC to our R&TTE products from our DoC server:
<http://www.doc.panasonic.de>

Contact to Authorised Representative: Panasonic Marketing Europe GmbH,
 Panasonic Testing Centre, Winsbergring 15, 22525 Hamburg, Germany

This product is in compliance with the radio standards of the following countries.

Austria, Belgium, Bulgaria, Cyprus, Czech Republic, Denmark, Finland, France, Germany, Greece, Hungary, Ireland, Italy, Iceland, Liechtenstein, Luxembourg, Malta, Netherlands, Norway, Poland, Portugal, Romania, Slovakia, Slovenia, Spain, Sweden, United Kingdom, Switzerland

The WLAN feature of this product shall exclusively be used inside buildings.

This product on purpose to connect to access point of 2.4 GHz or 5 GHz WLAN.

[After 13 June, 2017]**Declaration of Conformity (DoC)**

Hereby, "*Panasonic Corporation*" declares that this product is in compliance with the essential requirements and other relevant provisions of Directive 2014/53/EU.

Customers can download a copy of the original DoC to our RE products from our DoC server:
<http://www.doc.panasonic.de>

Contact to Authorised Representative:
 Panasonic Marketing Europe GmbH, Panasonic Testing Centre,
 Winsbergring 15, 22525 Hamburg, Germany

5.15 - 5.35 GHz band is restricted to indoor operations only in the following countries.

| | | | | | | | | | | |
|----|----|----|----|----|----|----|----|----|----|----|
| AT | BE | BG | CZ | DK | EE | FR | DE | IS | IE | IT |
| EL | ES | CY | LV | LI | LT | LU | HU | MT | NL | NO |
| PL | PT | RO | SI | SK | TR | FI | SE | CH | UK | HR |

| Type of wireless | Frequency band | Maximum power (dBm e.i.r.p.) |
|------------------|----------------|------------------------------|
| WLAN | 2412-2472 MHz | 20 dBm |
| | 5180-5320 MHz | 23 dBm |
| | 5500-5700 MHz | 23 dBm |

Manufactured by: **Panasonic Corporation**
 Kadoma, Osaka, Japan
 Importer for Europe: **Panasonic Marketing Europe GmbH**
 Panasonic Testing Centre
 Winsbergring 15, 22525 Hamburg, Germany

EU



Panasonic Corporation
 Web Site: <http://www.panasonic.com>



TQBS0033-1