

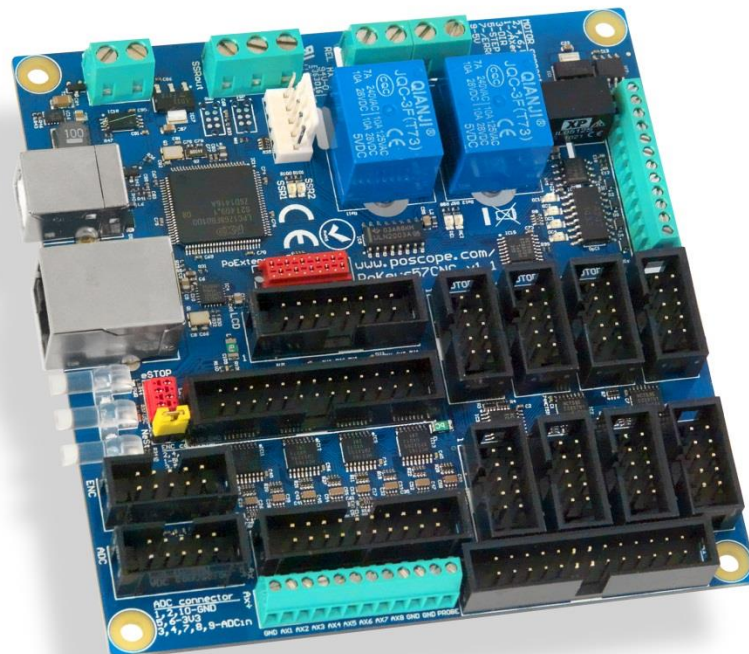

PoKeys57CNC User's manual

Version: 26/9/2016



Please read the following notes

1. All information included in this document is current as of the date this document is issued. Such information, however, is subject to change without any prior notice.
2. PoLabs does not assume any liability for infringement of patents, copyrights, or other intellectual property rights of third parties by or arising from the use of PoLabs products or technical information described in this document. No license, express, implied or otherwise, is granted hereby under any patents, copyrights or other intellectual property rights of PoLabs or others. PoLabs claims the copyright of, and retains the rights to, all material (software, documents, etc.) contained in this release. You may copy and distribute the entire release in its original state, but must not copy individual items within the release other than for backup purposes.
3. Descriptions of circuits, software and other related information in this document are provided only to illustrate the operation of the products and application examples. You are fully responsible for the incorporation of these circuits, software, and information in the design of your equipment. PoLabs assumes no responsibility for any losses incurred by you or third parties arising from the use of these circuits, software, or information.
4. PoLabs has used reasonable care in preparing the information included in this document, but PoLabs does not warrant that such information is error free. PoLabs assumes no liability whatsoever for any damages incurred by you resulting from errors in or omissions from the information included herein.
5. PoLabs devices may be used in equipment that does not impose a threat to human life in case of the malfunctioning, such as: computer interfaces, office equipment, communications equipment, test and measurement equipment, audio and visual equipment, home electronic appliances, machine tools, personal electronic equipment, and industrial robots.
6. Measures such as fail-safe function and redundant design should be taken to ensure reliability and safety when PoLabs devices are used for or in connection with equipment that requires higher reliability, for example: traffic control systems, anti-disaster systems, anticrime systems, safety equipment, medical equipment not specifically designed for life support, and other similar applications.
7. PoLabs devices shall not be used for or in connection with equipment that requires an extremely high level of reliability and safety, as for example: aircraft systems, aerospace equipment, nuclear reactor control systems, medical equipment or systems for life support (e.g. artificial life support devices or systems), and any other applications or purposes that pose a direct threat to human life.
8. You should use the PoLabs products described in this document within the range specified by PoLabs, especially with respect to the maximum rating, operating supply voltage range and other product characteristics. PoLabs shall have no liability for malfunctions or damages arising out of the use of PoLabs products beyond such specified ranges.
9. Although PoLabs endeavors to improve the quality and reliability of its products, semiconductor products have specific characteristics such as the occurrence of failure at a certain rate and malfunctions under certain use conditions. Further, PoLabs products are not subject to radiation resistance design. Please be sure to implement safety measures to guard them against the possibility of physical injury, and injury or damage caused by fire in the event of the failure of a PoLabs product, such as safety design for hardware and software including but not limited to redundancy, fire control and malfunction prevention, appropriate treatment for aging degradation or any other appropriate measures.
10. Usage: the software in this release is for use only with PoLabs products or with data collected using PoLabs products.
11. Fitness for purpose: no two applications are the same, so PoLabs cannot guarantee that its equipment or software is suitable for a given application. It is therefore the user's responsibility to ensure that the product is suitable for the user's application.
12. Viruses: this software was continuously monitored for viruses during production, however the user is responsible for virus checking the software once it is installed.
13. Upgrades: we provide upgrades, free of charge, from our web site at www.poscope.com. We reserve the right to charge for updates or replacements sent out on physical media.
14. Please contact a PoLabs support for details as to environmental matters such as the environmental compatibility of each PoLabs product. Please use PoLabs products in compliance with all applicable laws and regulations that regulate the inclusion or use of controlled substances, including without limitation, the EU RoHS Directive. PoLabs assumes no liability for damages or losses occurring as a result of your noncompliance with applicable laws and regulations.
15. Please contact a PoLabs support at support@poscope.com if you have any questions regarding the information contained in this document or PoLabs products, or if you have any other inquiries.
16. The licensee agrees to allow access to this software only to persons who have been informed of and agree to abide by these conditions.
17. Trademarks: Windows is a registered trademark of Microsoft Corporation. PoKeys, PoKeys55, PoKeys56U, PoKeys56E, PoKeys57U, PoKeys57E, PoKeys57CNC, PoKeys57CNCdb25, PoScope, PoLabs and others are internationally registered trademarks.

Contents

1.	Introduction.....	7
2.	Features.....	8
3.	Device hardware description.....	9
3.1.	PoKeys57CNC connector pinout.....	11
	Pin types	11
	Power supply	11
	SSR (Solid State Relay) connector.....	12
	Relays connector	12
	Galvanically isolated I/Os	12
	LCD connector	12
	Pendant connector.....	13
	Encoders connector.....	15
	ADC connector.....	15
	Motor connectors 1-8	16
	Axis switches connector	16
	Additional limit switches	16
	DB-25 (LPT-port) IO connector	17
3.2.	Pin types and specifications	18
	Type DI5P: Digital input with filtering	18
	Type DO5: 5 V digital output	18
	Type DO5_D: 5 V digital output without resistor	18
	Type DIO33: 3,3 V digital input or output	19
	Type OCOC: opto-coupled open-collector output	19
	Type OCSSR: open-collector output for SSR (Solid State Relay).....	20
	Type REL: relay output	20
	Type AN33: 3.3 V analog input	20
	Type AN33F: 3.3 V analog input with low-pass filter	21
3.3.	Status LEDs	21
4.	Requirements	22
5.	Technical specifications.....	23
5.1.	PoKeys57CNC dimensions	23
5.2.	Environment specifications	23
6.	Installation.....	24

6.1.	Using USB	24
6.2.	Using Ethernet - direct connection between PoKeys57CNC and computer	24
6.3.	Using Ethernet - PoKeys57CNC connected to a network with DHCP server.....	25
6.1.	Using USB and Ethernet	25
6.2.	Motor drivers and peripherals installation	25
7.	PoKeys configuration options.....	26
7.1.	Digital inputs and outputs	26
	PoKeys configuration software usage	26
7.2.	Digital counters	28
	PoKeys configuration software usage	28
7.3.	Encoders	29
	PoKeys configuration software usage	30
7.4.	Pulse engine	32
	Pulse engine status/control dialog parts.....	33
	Axis configuration panel.....	34
	Homing algorithm configuration	35
	Common homing algorithm configurations	36
	Limit and home switch filters	37
	PoStep drivers configuration.....	37
	Connecting PoStep drivers to PoKeys57CNC.....	38
7.5.	Matrix keyboard	40
	PoKeys configuration software usage	40
7.6.	Analog inputs.....	42
	PoKeys configuration software usage	42
7.7.	Joystick mapping	43
	PoKeys configuration software usage	43
7.8.	PWM outputs	44
	PoKeys configuration software usage	45
7.9.	LCD.....	46
	PoKeys configuration software usage	46
7.10.	PoExtBus	49
	PoKeys configuration software usage	49
	PoExtBus connector type	49
7.11.	PoNET	50

Adding new devices.....	51
PoNET kb48CNC keyboard.....	52
7.12. Failsafe settings	53
7.13. Peripheral communication protocols.....	54
I ² C protocol.....	54
1-wire.....	55
7.14. EasySensors	56
EasySensors configuration dialog.....	56
Scan for I ² C sensors	56
Scan for 1-wire sensors	57
Add DHTxx 1-Wire sensor.....	57
Add analog sensor	57
List of supported sensors	59
7.15. USB interface configuration	60
Start options	60
Communication interval.....	60
Enabling/disabling the interfaces.....	61
7.16. Network device functionality	62
Device discovery.....	62
Default network settings	63
Connecting to device in other network.....	63
Security.....	64
Web interface (dashboard)	65
Modbus.....	68
Reporting data to network server with PoKeys57CNC device	71
7.17. Changing User ID number	77
7.18. Saving current configuration to file.....	77
7.19. PoIL core functionality.....	77
8. Device recovery mode.....	78
9. Frequently asked questions	79
10. Errata information.....	80
PoKeys device resets when external power supply is applied or removed	80
External pull-up resistor needed on the probing input.....	80
11. Grant of license	81

1. Introduction

PoKeys products line consists of simple, easy-to-use USB and network devices with the extended list of features making them powerful input/output devices. PoKeys57CNC features both USB and Ethernet connectivity, giving user an option to select the preferred connection for the application. The device is highly adjustable and as such requires no complex knowledge on device programming.

PoKeys57CNC is a blend between general purpose PoKeys device and motor controller. The device is targeted primarily for controlling up to 8 STEP/DIR signal driven motors (stepper motors, servo drives, etc.) in various applications with the addition of powerful PoKeys device features. Device contains dedicated connectors for connections with motor drivers, pendants, (HD44780-compatible) LCD module, etc. In addition, 5 analog inputs with 12-bit resolution are available. The device also features four galvanically-isolated open-collector outputs and 0 to 10 V analog output.

The device runs the PoIL core and is fully compatible with PoBlocks graphical programming software, bringing Programmable Logic Controller to a motor controller board. PoBlocks can be used to simply automate different peripherals and interchange data with other software applications that are using PoKeys57CNC device.

PoKeys USB products integrate support for virtual USB keyboard and USB joystick, which can be used to emulate a standard USB keyboard and joystick. Digital input pins can be mapped to virtual keyboard and joystick keys, while analog inputs can be mapped to virtual joystick axes. Configuration is simple by using our intuitive graphical PoKeys configuration application, where each function can also be tested.

A dedicated PoExtBus/PoNET connector can be used to extend the number of digital outputs for additional 80 outputs in the form of either relay outputs or open-collector outputs. It can also be used to connect various additional peripherals (e.g. PoKeysKBD48CNC pendant) and I²C sensors.

Third-party application developers that are adding the support for PoKeys devices, are encouraged to use the supplied communication DLL that can be simply used in the different .NET framework based applications and various other programming languages that provide support for ActiveX interface. There is even an open-source cross-platform C library available at <https://bitbucket.org/mbosnak/pokeyslib>.

To aid developers that are communicating with PoKeys devices on the low-level, the extensive documentation on device communication protocol can be downloaded free of charge from the product webpage.

2. Features

- Compatible with USB 1.1/2.0 HID standard,
- standard English USB keyboard simulation (with triggering support for up/down keys),
- standard USB joystick simulation (6 axes, 32 buttons with triggering support),
- Ethernet 10/100 with DHCP client or fixed IP support,
- TCP or UDP connection with the device,
- Modbus TCP support (access to digital IO, analog inputs, encoder values, digital counters values, PWM outputs, LCD display, PoExtBus devices, matrix keyboard status),
- web interface with newly designed dashboard and I/O status display with multiple user accounts,
- 28 digital inputs or outputs (software configurable) with pull-up resistors and available as virtual USB keyboard keys. There are additional 4 dedicated digital outputs,
- 5 analog inputs (12-bit) with digital low-pass filtering (4 analog inputs also include analog low-pass filter with 1.9 kHz cut-off frequency),
- multiple encoder pair inputs with three additional dedicated high-speed encoder and one ultra high-speed encoder inputs,
- digital counters on specific digital input pins,
- high performance 8-axis 125 kHz pulse engine with dedicated motor connectors,
- up to 16x8 matrix keyboard with triggered keys/alternate function support,
- up to 4 high-speed fully configurable PWM outputs (25MHz PWM timer) - two of them with open-collector transistor outputs,
- dedicated connector for HD44780-based character LCD (up to 4x20 characters),
- dedicated connector for PoPendant1,
- PoExtBus support for adding up to 10 external shift registers (e.g. PoExtBusOC16, PoExtBusRE, etc.),
- PoNET devices support (48-key CNC keyboard),
- fail-safe support in case of communication interruption,
- support for up to 100 sensors, that can be connected to I²C bus, 1-wire bus or on the general purpose analog inputs,
- intuitive and user-friendly software,
- third-party support via communication DLL library and extensive protocol specification document that allows porting to other systems.

3. Device hardware description

PoKeys57CNC v1.2

pinout illustration
December 2015
Copyright © PoLabs

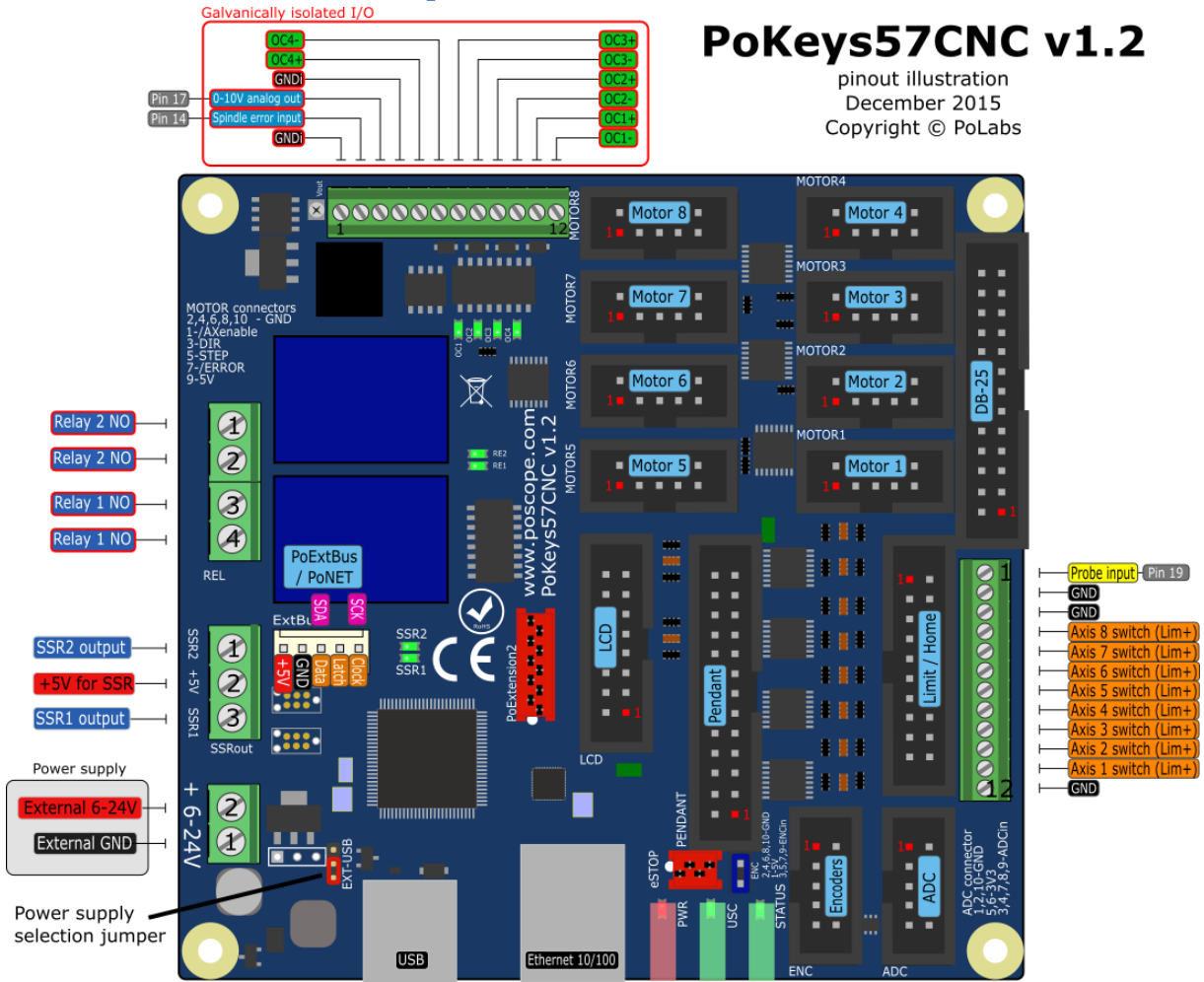

Motor connectors 1-8

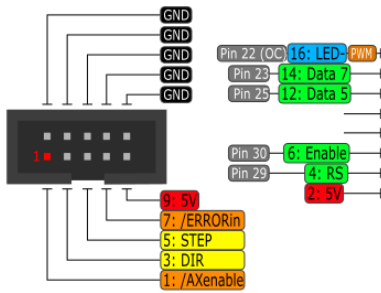

LCD connector

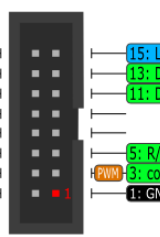

Pendant connector

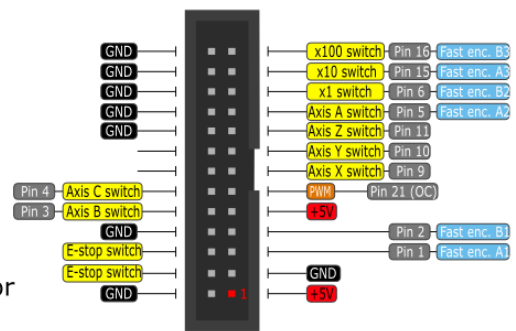

Encoders connector

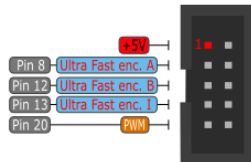

DB-25 connector

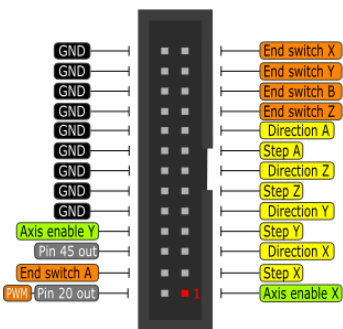

Axis switches connector

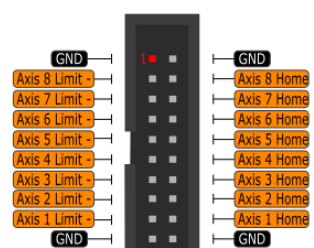

Analog inputs connector

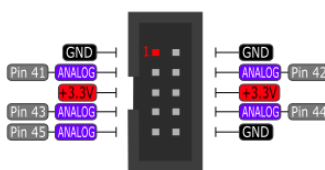

PoKeys57CNC

pinout illustration
March 2015
Copyright © PoLabs

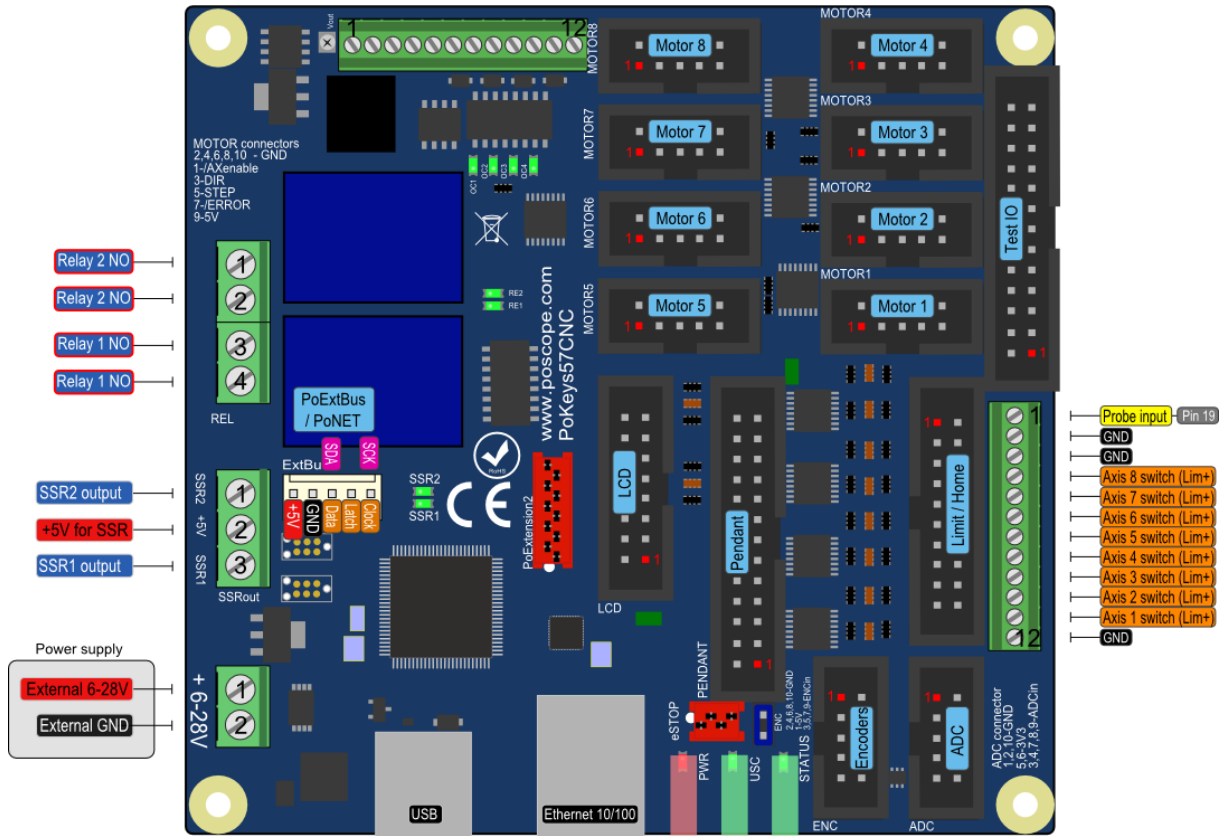
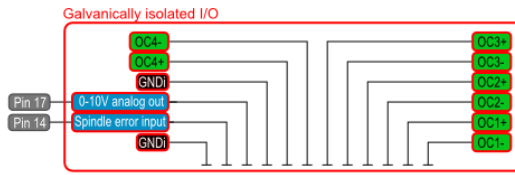

Motor connectors 1-8

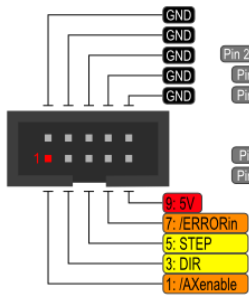

LCD connector

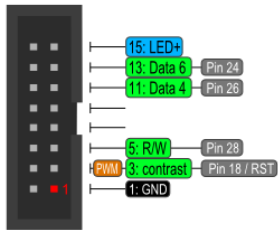

Pendant connector

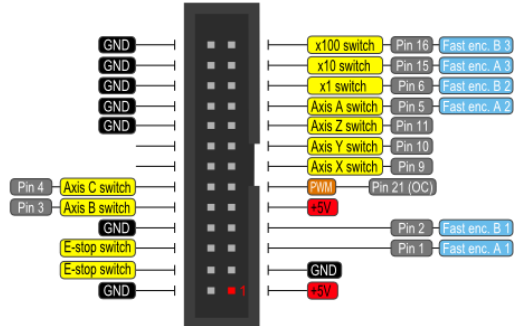

Encoders connector

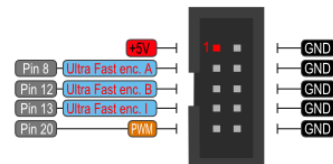

Test IO connector

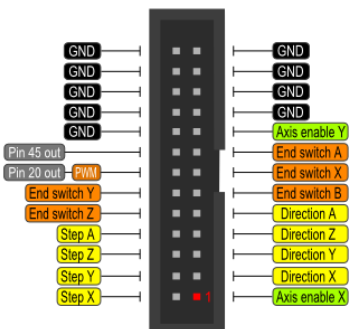

Analog inputs connector

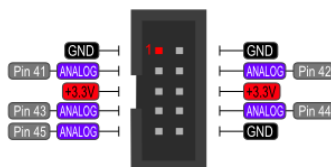

Axis switches connector

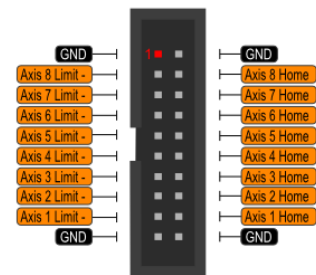

3.1. PoKeys57CNC connector pinout

Pin types

Type code	Description
DI5P	5 V digital input with input filtering
DI33P	3,3 V digital input with input filtering
DO5	5 V digital output
DO5_D	5 V digital output without series resistor
DIO33	3,3 V digital input or output without filtering
OCOC	Opto-coupled open-collector output
OCSSR	Open-collector outputs for SSR
REL	Relay output
AN33	3,3 V analog input without filtering
AN33F	3,3 V analog input with 1,9 kHz low-pass filtering

See chapter 3.2 *Pin types* for details on the listed pin types.

Power supply

Pin	Type	Function
1	Supply input	Positive power supply 6-26V (marked with +)
2	Supply input	Negative power supply (ground)

PoKeys57CNC requires external 6-26V power supply to be connected to the board in order for the device to operate correctly (**device may not operate according to the specifications if the external power supply is not present**). The device uses switching power converter to scale down the input power supply to 5V. The power supply should be capable of providing at least 2.5W.

The PoKeys57CNC v1.2 features a jumper to select the power supply source. Move the jumper to the 'USB' position during testing the board without the external power supply connected. Otherwise, put the jumper to the 'EXT' position.

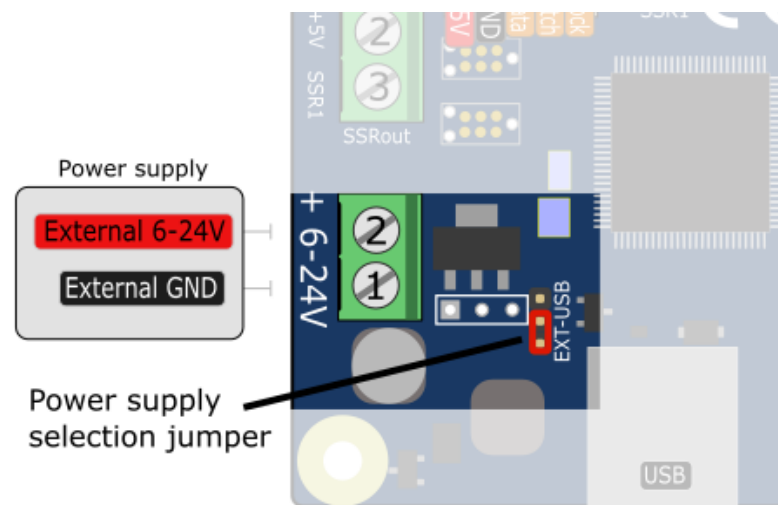

SSR (Solid State Relay) connector

Pin	Type	Function
1	OCSSR	SSR2 output
2	+5V	+5V output (power supply to SSR relay)
3	OCSSR	SSR1 output

The solid state relays should be connected between +5V output and corresponding SSR output pin.

Note: all +5V output pins on the board share the same power supply and the current is distributed to all loads.

Relays connector

Pin	Type	Function
1	REL	Relay 2 NO
2	REL	Relay 2 common
3	REL	Relay 1 NO
4	REL	Relay 1 common

Galvanically isolated I/Os

This connector contains special I/O signals that are galvanically isolated from the rest of the board. Signals on pins 2 and 3 should only be referenced to GNDi points (available on pins 1 and 4).

Pin	Type	Label	Function
1	GNDi	GNDi	Isolated ground connection (for use only with signals on this connector)
2	DI5P	SpEr	Spindle error input
3	-	10V	0-10V analog output
4	GNDi	GNDi	Isolated ground connection
5	OCOC	OC4+	Open collector output 4
6	OCOC	OC4-	
7	OCOC	OC3+	Open collector output 3
8	OCOC	OC3-	
9	OCOC	OC2+	Open collector output 2
10	OCOC	OC2-	
11	OCOC	OC1+	Open collector output 1
12	OCOC	OC1-	

LCD connector

Pin	Type	Label	Function
1	GND	GND	Ground
2	+5V	+5V	+5V power supply for LCD
3	DIO33	RST	LCD contrast voltage, also used as PoKeys pin 18 with PWM and reset pin (see Device recovery mode for more details)
4	DIO33	RS	LCD RS signal, also used as PoKeys pin 29 ¹
5	DIO33	R/W	LCD R/W signal, also used as PoKeys pin 28
6	DIO33	E	LCD Enable signal, also used as PoKeys pin 30 ¹

¹ Digital counter functionality can be enabled for this pin

7	-	-	not connected
8	-	-	not connected
9	-	-	not connected
10	-	-	not connected
11	DIO33	D4	LCD D4 signal, also used as PoKeys pin 26
12	DIO33	D5	LCD D5 signal, also used as PoKeys pin 25
13	DIO33	D6	LCD D6 signal, also used as PoKeys pin 24
14	DIO33	D7	LCD D7 signal, also used as PoKeys pin 23
15	+5V	LED+	+5 V power supply for LCD backlight with 4,7 Ω resistor in series
16	OC	LED-	Open-collector output (max. 100 mA), also used as PoKeys pin 22 with PWM

Pendant connector

Pin	Type	Label	Function
1	+5V	+5V	+5 V power supply to pendant (used for encoder/MPG power)
2	GND	GND	Ground
3	GND	GND	Ground
4	DI33P	E-stop	E-stop signal input, also used as PoKeys pin 52 (connect E-stop switch between pins 4 and 6) - see notes below
5	DIO33	FastEncA	Encoder channel A, also used as PoKeys pin 1 ²
6	GND-E	E-Stop	E-stop switch GND - see notes below
7	DIO33	FastEncB	Encoder channel B, also used as PoKeys pin 2 ²
8	GND	GND	Ground
9	+5V	LED+	+5 V power supply for pendant LED
10	DI33P	Ax-B	Axis B selection signal, also used as PoKeys pin 3 ²
11	OC	LED-	Open-collector output (max. 100 mA), also used as PoKeys pin 21 with PWM
12	DI33P	Ax-C	Axis C selection signal, also used as PoKeys pin 4 ²
13	DI33P	Ax-X	Axis X selection signal, also used as PoKeys pin 9 ²
14	-	-	not connected
15	DI33P	Ax-Y	Axis Y selection signal, also used as PoKeys pin 10 ²
16	-	-	not connected
17	DI33P	Ax-Z	Axis Z selection signal, also used as PoKeys pin 11 ²
18	GND	GND	Ground
19	DI33P	Ax-A	Axis A selection signal, also used as PoKeys pin 5 ²
20	GND	GND	Ground
21	DI33P	Step x1	Step x1 selection signal, also used as PoKeys pin 6 ²
22	GND	GND	Ground
23	DI33P	Step x10	Step x10 selection signal, also used as PoKeys pin 15 ²
24	GND	GND	Ground
25	DI33P	Step x100	Step x100 selection signal, also used as PoKeys pin 16 ²
26	GND	GND	Ground

Note: E-stop switch can be connected either to dedicated E-stop connector (red 4-pin connector) or to pendant connector (a combination of both is also allowed since both are wired in series).

² Digital counter functionality can be enabled for this pin

- a) E-stop switch is connected to dedicated 4-pin E-stop connector between pins 2 and 3. Jumper 'NeST' must be removed and inserted into the pendant connector between pins 4 and 6
- b) E-stop switch is connected to pendant connector (between pins 4 and 6). Jumper 'NeST' must be present
- c) Two E-stop switches are connected - one to dedicated 4-pin E-stop connector (between pins 2 and 3) and one to pendant connector (between pins 4 and 6).

Encoders connector

Pin	Type	Label	Function
1	+5V	+5V	Axis enable signal (inverted)
2	GND	GND	Ground
3	DIO33	uFEA	Ultra-fast encoder A-channel signal input, also used as PoKeys pin 8
4	GND	GND	Ground
5	DIO33	uFEB	Ultra-fast encoder B-channel signal input, also used as PoKeys pin 12
6	GND	GND	Ground
7	DIO33	uFEI	Ultra-fast encoder index signal input, also used as PoKeys pin 13
8	GND	GND	Ground
9	DIO33	PK20	PoKeys pin 20 with PWM ³
10	GND	GND	Ground

ADC connector

Pin	Type	Label	Function
1	GND	GND	Ground
2	GND	GND	Ground
3	AN33F	PK41	PoKeys pin 41
4	AN33F	PK42	PoKeys pin 42
5	+3,3V	+3,3V	
6	+3,3V	+3,3V	
7	AN33F	PK43	PoKeys pin 43
8	AN33F	PK44	PoKeys pin 44
9	AN33/DIO33	PK45	PoKeys pin 45
10	GND	GND	Ground

³ Digital counter functionality can be enabled for this pin

Motor connectors 1-8

Pin	Type	Label	Function
1	DO5	/AXEn	Axis enable signal (inverted)
2	GND	GND	Ground
3	DO5	DIR	Direction signal
4	GND	GND	Ground
5	DO5	STEP	Step signal
6	GND	GND	Ground
7	DI5P	/ERRORin	Error input signal (from stepper driver to PoKeys)
8	GND	GND	Ground
9	+5V	5V	+5V output to stepper driver
10	GND	GND	Ground

Axis switches connector

Pin	Type	Label	Function
1	GND	GND	Ground
2	GND	GND	Ground
3	DI5P	AX8-	Axis 8 limit- switch
4	DI5P	AX8 H	Axis 8 home switch
5	DI5P	AX7-	Axis 7 limit- switch
6	DI5P	AX7 H	Axis 7 home switch
7	DI5P	AX6-	Axis 6 (C) limit- switch
8	DI5P	AX6 H	Axis 6 (C) home switch
9	DI5P	AX5-	Axis 5 (B) limit- switch
10	DI5P	AX5 H	Axis 5 (B) home switch
11	DI5P	AX4-	Axis 4 (A) limit- switch
12	DI5P	AX4 H	Axis 4 (A) home switch
13	DI5P	AX3-	Axis 3 (Z) limit- switch
14	DI5P	AX3 H	Axis 3 (Z) home switch
15	DI5P	AX2-	Axis 2 (Y) limit- switch
16	DI5P	AX2 H	Axis 2 (Y) home switch
17	DI5P	AX1-	Axis 1 (X) limit- switch
18	DI5P	AX1 H	Axis 1 (X) home switch
19	GND	GND	Ground
20	GND	GND	Ground

Additional limit switches

Pin	Type	Label	Function
1	GND	GND	Ground
2	DI5P	AX1+	Axis 1 (X) limit+ switch
3	DI5P	AX2+-	Axis 2 (Y) limit+ switch
4	DI5P	AX3+	Axis 3 (Z) limit+ switch
5	DI5P	AX4+	Axis 4 (A) limit+ switch
6	DI5P	AX5+	Axis 5 (B) limit+ switch
7	DI5P	AX6+	Axis 6 (C) limit+ switch
8	DI5P	AX7+	Axis 7 limit+ switch

9	DI5P	AX8+	Axis 8 limit+ switch
10	GND	GND	Ground
11	GND	GND	Ground
12	DI5P	Probe	Probe input <i>On PoKeys57CNC v1.0, v1.1 and v1.2 external pull-up resistor must be used</i>

DB-25 (LPT-port) IO connector

Warning: on PoKeys57CNC v1.1 the pinout is not compatible with the LPT-based stepper drivers since the physical pin numbering sequence in PoKeys57CNC v1.1 differs from that of a real DB-25 connector. Check the pinout diagrams above.

The connector on the PoKeys57CNC v1.2 is compatible with the LPT-based stepper drivers.

Pin	Type	Label	Function
1	DO5	/AXEn1	Axis 1 (X) enable signal (inverted)
2	DO5	STEP1	Step signal for axis 1 (X)
3	DO5	DIR1	Direction signal for axis 1 (X)
4	DO5	STEP2	Step signal for axis 2 (Y)
5	DO5	DIR2	Direction signal for axis 2 (Y)
6	DO5	STEP3	Step signal for axis 3 (Z)
7	DO5	DIR3	Direction signal for axis 3 (Z)
8	DO5	STEP4	Step signal for axis 4 (A)
9	DO5	DIR4	Direction signal for axis 4 (A)
10	DI5P	AX3+	Axis 3 (Z) limit+ switch
11	DI5P	AX5+	Axis 5 (B) limit+ switch
12	DI5P	AX2+	Axis 2 (Y) limit+ switch
13	DI5P	AX1+	Axis 1 (X) limit+ switch
14	DO5_D	PK20	PoKeys pin 20 (output only)
15	DI5P	AX4+	Axis 4 (A) limit+ switch
16	DO5_D	PK45	PoKeys pin 45 (output only)
17	DO5	/AXEn2	Axis 2 (Y) enable signal (inverted)
18	GND	GND	Ground
19	GND	GND	Ground
20	GND	GND	Ground
21	GND	GND	Ground
22	GND	GND	Ground
23	GND	GND	Ground
24	GND	GND	Ground
25	GND	GND	Ground
26	GND	GND	Ground

3.2. Pin types and specifications

Type DI5P: Digital input with filtering

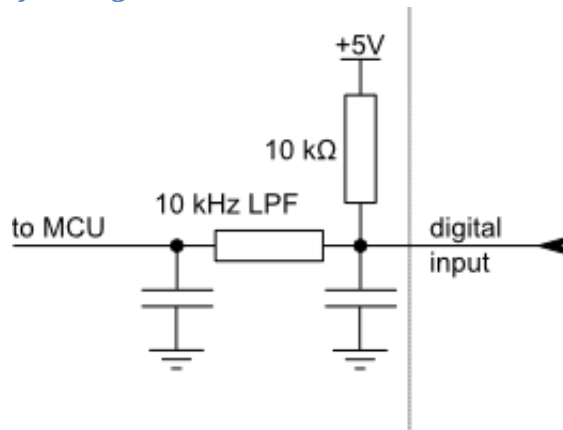

Symbol	Parameter	Min	Max	Unit
$V_{DI5P,MAX}$	maximum voltage applied to DI5P pin	-	5,5	V
$V_{DI5P,LOW}$	applied voltage for LOW state	-	0,2	V
$V_{DI5P,HIGH}$	applied voltage for HIGH state	1,6	-	V

Type DO5: 5 V digital output

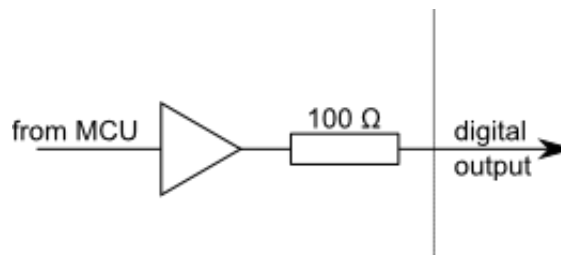

Symbol	Parameter	Min	Max	Unit
$I_{DO5,MAX}$	maximum current supplied by DO5 pin	-	8	mA
$V_{DO5,LOW}$	voltage of LOW state (no current)	-	0,1	V
$V_{DO5,HIGH}$	voltage of HIGH state (no current)	4,9	-	V
$R_{DO5,HIGH}$	internal resistance of the digital output	100	TBD	Ohm

Type DO5_D: 5 V digital output without resistor

Symbol	Parameter	Min	Max	Unit
$I_{DO5_D,MAX}$	maximum current supplied by DO5 pin	-	50	mA
$V_{DO5_D,LOW}$	voltage of LOW state (no current)	-	0,1	V
$V_{DO5_D,HIGH}$	voltage of HIGH state (no current)	4,9	-	V

Type DI033: 3,3 V digital input or output

Digital pin directly connected to MCU.

Symbol	Parameter	Min	Max	Unit
I_{pu}	pull-up current	0 ($V_i \geq 3.3V$)	-100	μA
Pin used as digital output				
$I_{DO33,MAX}$	maximum current supplied by DO33 pin	-	4	mA
$V_{DO33,LOW}$	voltage of LOW state (no current)	0	-	V
$V_{DO33,HIGH}$	voltage of HIGH state (no current)	-	3,3	V
Pin used as digital input				
$V_{DI5,MAX}$	maximum voltage applied to DI5 pin	-	5,0	V
$V_{DI5,LOW}$	applied voltage for LOW state	-	0,8	V
$V_{DI5,HIGH}$	applied voltage for HIGH state	2,0	-	V

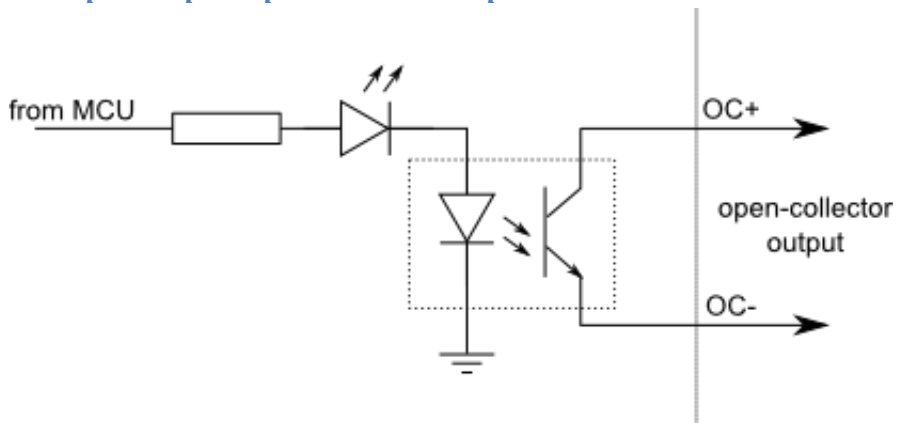
Type OCOC: opto-coupled open-collector output

Symbol	Parameter	Min	Max	Unit
$I_{OCOC,MAX}$	maximum output current	-	50	mA
$V_{OCOC,DIFF}$	maximum voltage applied between OC+ and OC-	-	50	V
$V_{OCOC,ISO}$	isolation voltage (AC for 1min, R.H. 40-60%)	-	3000	V_{RMS}

Type OCSSR: open-collector output for SSR (Solid State Relay)

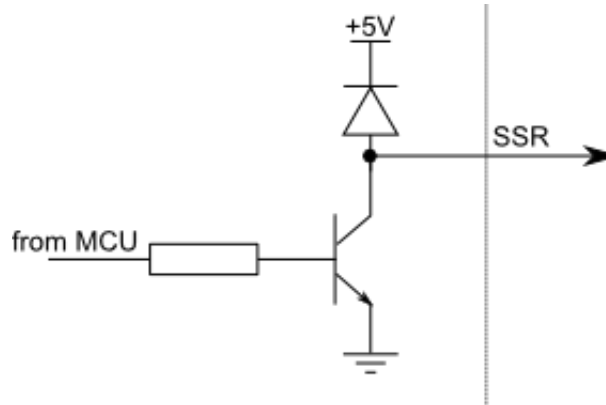

Symbol	Parameter	Min	Max	Unit
$I_{OCSSR,MAX}$	maximum current sunk by OCSSR pin	-	500	mA
$U_{OCSSR,MAX}$	maximum voltage applied to OCSSR pin	-	5	V

Type REL: relay output

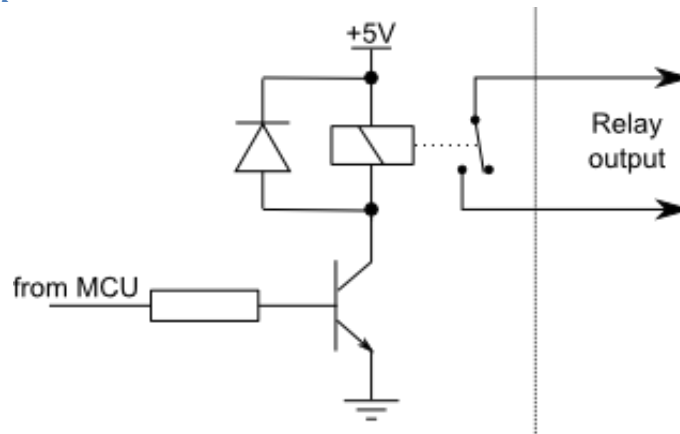

Symbol	Parameter	Min	Max	Unit
$I_{REL,28VDC}$	maximum current switching at 28 VDC	-	10	A
$I_{REL,125VAC}$	maximum current switching at 125 VAC	-	10	A
$I_{REL,240VAC}$	maximum current switching at 240 VAC	-	7	A

Type AN33: 3.3 V analog input

Symbol	Parameter	Min	Max	Unit
V_{IA}	analog input voltage on ADC related pins	-0.5	3.3	V

Type AN33F: 3.3 V analog input with low-pass filter

Symbol	Parameter	Min	Max	Unit
V_{IA}	analog input voltage on ADC related pins	-0.5	3.3	V
f_{LP}	cut-off frequency of the analog low-pass filter	1.6	2.2	kHz

3.3. Status LEDs

- TBD

4. Requirements

- 6-26 V power supply with 2.5 W or more,
- one available USB 1.1 or USB 2.0 port,
- Ethernet connection between host computer and PoKeys57CNC device,
- USB HID device driver enabled operating system (Windows 98 SE/ME/2000/XP/Vista, Linux, Mac OS),
- included software requires Windows XP/Vista/7/8/8.1 with .NET framework 3.5 installed.

5. Technical specifications

5.1. PoKeys57CNC dimensions

Measurements are in mm.

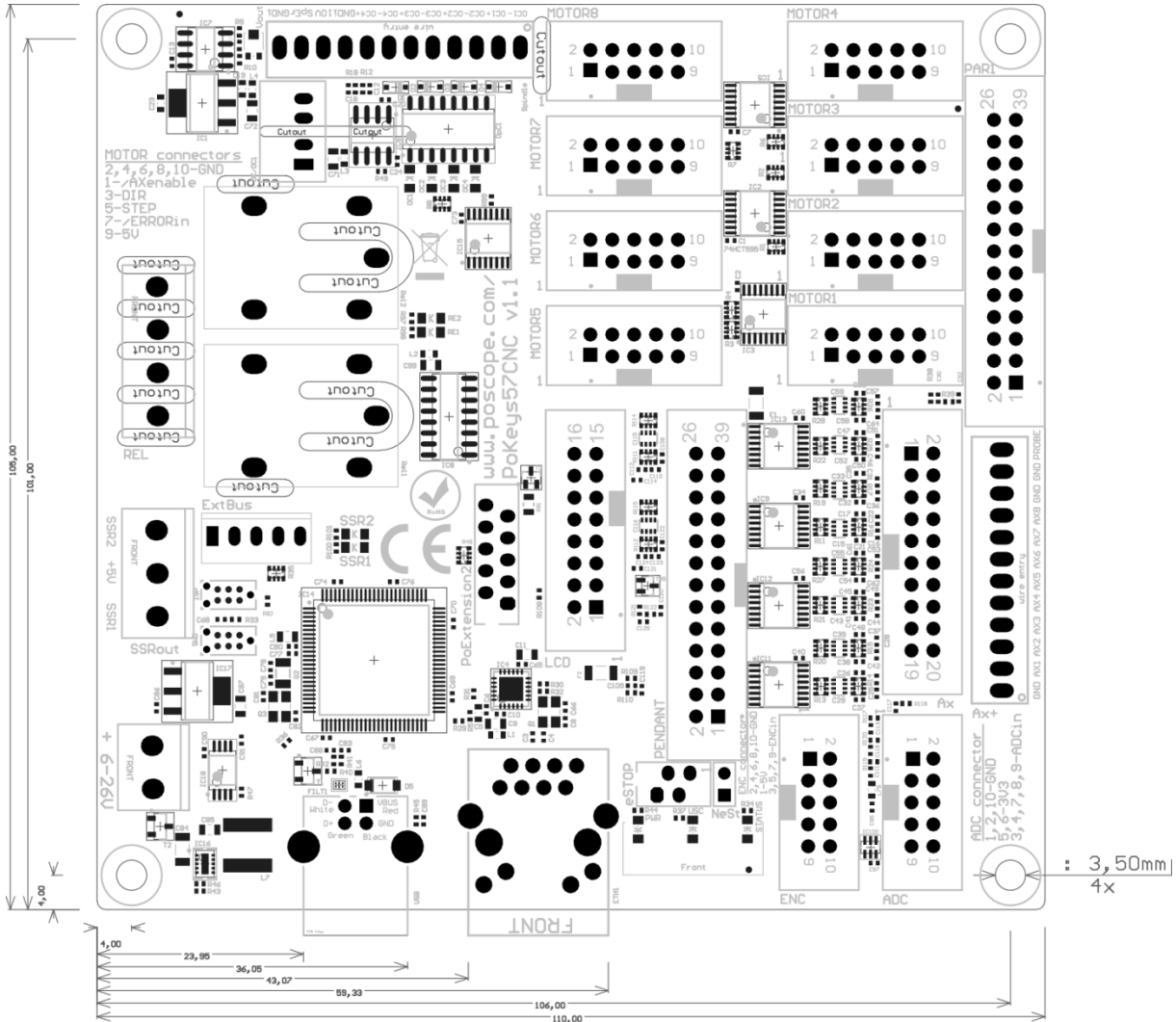

5.2. Environment specifications

Parameter	Min	Typ	Max	Unit
Power supply range	6	-	26	V
Operating temperature	0	-	60	°C
Storage temperature	-40	-	85	°C
Humidity	5	-	95 (non-condensing)	% RH

6. Installation

6.1. Using USB

PoKeys57CNC is a USB 1.1/2.0 compliant device.

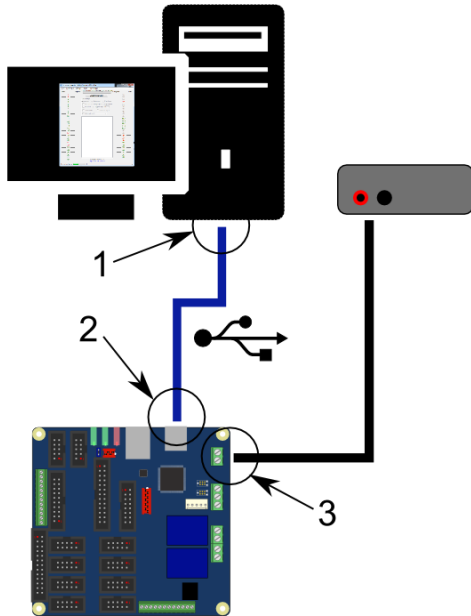

Step 1: Locate a free USB 2.0 port on your computer (1) and PoKeys57CNC board (2) and connect them with a standard USB cable.

Step 2: Connect the PoKeys57CNC board to an appropriate power supply (3).

Step 3: Install PoKeys software

Step 4: Open PoKeys application, connect to your PoKeys57CNC device and enable Fast USB interface (go to Settings > Enable Fast USB interface).

Step 5: Remove the USB cable from PoKeys57CNC device and insert it again. The computer will find a new device and search for drivers. See FAQ section of the manual if driver installation fails.

6.2. Using Ethernet - direct connection between PoKeys57CNC and computer

Network firewalls must allow all traffic on TCP/UDP port 20055 between PoKeys57CNC device and PoKeys-related software running on a computer.

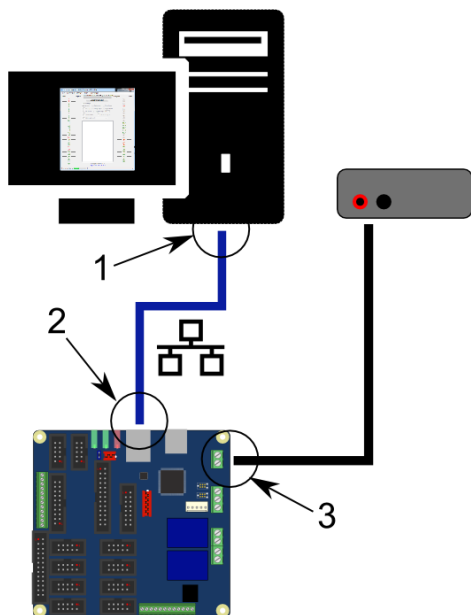

Step 1: Locate ethernet ports on your computer (1) and PoKeys57CNC board (2) and connect them with RJ-45 cable (standard network cable).

Step 2: Connect the PoKeys57CNC board to an appropriate power supply (3).

Step 3: Configure your computer's network card with a static IP address in the 192.168.x.x range

Step 4: Install PoKeys software

Step 5: Start PoKeys software, select the PoKeys57CNC device in the list and click on 'Configure' button. Select the unique IP address for the PoKeys57CNC device in the same range as the computer's network card

6.3. Using Ethernet - PoKeys57CNC connected to a network with DHCP server

Network firewalls must allow all traffic on TCP/UDP port 20055 between PoKeys57CNC device and PoKeys-related software running on a computer.

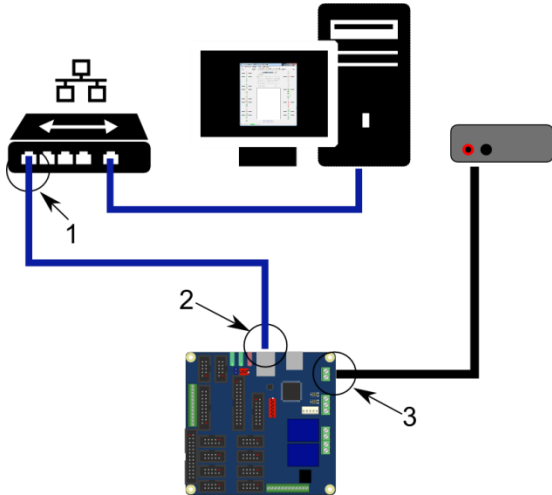

Step 1: Locate ethernet ports on your router (1) and PoKeys57CNC board (2) and connect them with RJ-45 cable (standard network cable).

Step 2: Connect the PoKeys57CNC board to an appropriate power supply (3).

Step 3: Install PoKeys software

6.1. Using USB and Ethernet

PoKeys57CNC device can also be connected to computer by using both the USB and Ethernet connection. In this case, applications will detect two instances of PoKeys57CNC devices and USB connection will be selected by default by third-party applications.

Follow the above instructions on connecting the PoKeys57CNC device over Ethernet and USB.

6.2. Motor drivers and peripherals installation

Connect motor drivers to dedicated 10-pin axis motor connectors, marked as MOTOR1, MOTOR2 ... MOTOR8.

Connect pendant to the dedicated pendant connector.

7. PoKeys configuration options

7.1. Digital inputs and outputs

Unlike generic PoKeys devices, PoKeys57CNC doesn't have generic pin headers with fully customizable pin functions. Certain pins of the dedicated connectors on PoKeys57CNC can be reused for other purposes if not used by the specific peripheral device. See the connector pinout diagram to discover which pins can be reused as digital inputs or digital outputs. Pin numbers were assigned according to the available functions of each pin in order to keep the device back-compatible with 3rd party software.

Although primarily targetted for CNC applications, PoKeys57CNC shares the same virtual USB keyboard and joystick capability of PoKeys USB series of devices. Digital pins can be mapped to virtual keyboard keys or virtual joystick buttons. On activation, PoKeys device sends a USB message with the key code and modifier associated with this pin. Moreover, PoKeys57CNC device can also simulate a series of key presses, what is called a macro sequence. Up to 64 different macro sequences can be setup with the combined total length of 3584 characters with each macro sequence shorter than 128 keys. All macros can be labelled with a 7-character name.

An extension to the USB keyboard mapping described above, PoKeys supports also triggered mapping of inputs to USB keyboard keys. In triggered mapping mode, only pin state transitions (low-to-high or high-to-low trigger a USB key press) with different key combinations for each transition.

Type-matic like repeat and delay is an additional extension to the triggered key mapping. Instead of relying on the user's system to trigger key repeat events, PoKeys can be configured to simulate repeated key presses at the predefined rate (period between two key presses is adjustable in 5 ms cycles – 0.78 to 200 repeats possible⁴) after a predefined delay (adjustable in steps of 5 ms – 0 to 1275 ms possible).

PoKeys configuration software usage

There is graphical representation for configuration of each PoKeys device's pin on left and right side of main window. To change pin function, click on pin name and change its function in central 'Pin settings' frame.

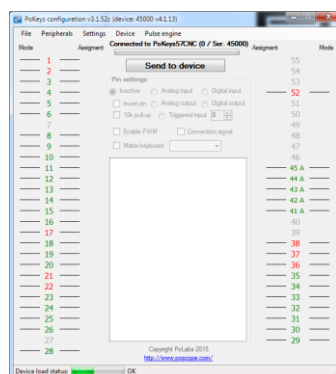

Figure 1: PoKeys configuration window

⁴ The maximum repeat rate depends on the user's system

There are 6 main pin functions possible: inactive, digital input, triggered digital input, digital output, analog input, depending on the capabilities of each pin.

Inactive

Any pin (except those fixly mapped to an activated peripheral) can be set as inactive. Inactive pin is put in high-Z state with internal pull-up resistors enabled.

Digital input

Any free pin can be configured as digital input by selecting 'Digital input' option box. If the pin polarity is wished to be inverted, check the 'Invert pin' box.

There are several additional possibilities for digital input pin functions.

Direct key mapping - only if connected over USB

Digital input set up for direct key mapping acts like a keyboard key. When there is a high state on pin (on low state when using inverted option), PoKeys device sends a key associated with this pin. Select a keyboard key from drop-down box and check appropriate key modifiers (Shift, Ctrl, ...).

Triggered digital input

Triggered digital input function is activated by selecting 'Triggered input' option box. This pin mode enables user to select a key that is pressed only when a transition in a signal occurs. Different keys can be selected for 'LOW-to-HIGH' or 'Key up' event and for 'HIGH-to-LOW' or 'Key down' event. Selecting the keys is similar to Direct key mapping described above.

Digital output

Most of the available pins (check the pin capabilities in device pinout section of this manual) can be configured as digital output by selecting 'Digital output' option box. If the polarity of the pin is wished to be inverted, check the 'Invert pin' box. On startup, all pins (although optionally configured as digital output) are by default initialized in high-Z state (behaving like inputs). To use the outputs, SetPinData should be called before attempting to set the output state. However, there is an option to disable this behaviour - use the 'Settings > Initialize outputs on startup' option to either enable or disable output activation on PoKeys startup.

View status of digital inputs and outputs

Go to 'Peripherals > Digital inputs and outputs...' to display the status dialog as shown below.

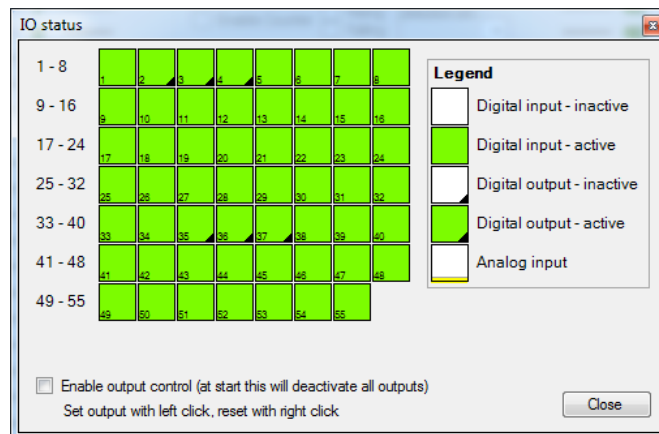

Figure 2: Input and output status dialog

There are 55 pins represented as colored squares in the dialog, organized in the rows of 8 pins. Each square contains a pin index number in the lower left corner, while the lower right corner is used to indicate a digital output (small black triangle is displayed on pins, configured as digital outputs). The color of the square resembles the current state of the pin – green for the activated (HIGH state) and white for the unactivated (LOW state).

To change the digital output state, first enable ‘Enable output control’ option, then either left or right click with mouse on the square representing the digital output to activate or deactivate this output.

7.2. Digital counters

Selected pins of the PoKeys device can be setup to count the number of signal transitions on those pins. Pin digital counter can be setup to be incremented/decremented on rising, falling or rising and falling edges of the input signal. If needed, additional pin can be selected to toggle between incrementing and decrementing mode.

Digital counters are implemented using interrupts and can therefore detect short signal pulses (even shorter than 1 microsecond). If switches are used in the combination with digital counters, external debouncing circuit must be installed to keep the digital counters from counting additional pulses due to switch contact bouncing on making or braking the contact.

Check PoKeys device pinout section to discover which pins are compatible with digital counter option.

PoKeys configuration software usage

To setup digital counter inputs, first set the selected pin as ‘Digital input’ and if digital counter is available on the selected pin, the ‘Enable counter’ option will be enabled. Check this option and check ‘rising’ and/or ‘falling’ edge counting option.

To enable selection between incrementing or decrementing counter modes, a direction pin can be selected in the ‘Direction pin’ drop-down menu. If no pin is selected, the counter mode defaults to incrementing mode.

Digital counters values status page (menu ‘Peripherals > Digital counters values...’) can be used to check the proper working of the configured digital counters

7.3. Encoders

PoKeys devices can handle decoding of up to 26 pairs of quadrature encoder signals. A and B signals of 25 'normal' encoders can be connected to any digital input and are intended for hand-driven rotational encoder switches with the quadrature signal frequencies up to 1 kHz.

Three fast encoders input pairs are available only on selected input pins (pins 1-2 as encoder 1, pins 5-6 as encoder 2, pins 15-16 as encoder 3) and can handle quadrature signal frequencies to about 100 kHz. When activated, fast encoders logically replace the 'normal' encoders 1, 2 and 3.

Although fast encoders can track encoders at high speed, using this feature can have an impact on device performance. It is not advised to use these to track axis position using a high-resolution encoder in connection with Pulse engine feature.

Ultra-fast encoder support is available on pins 8, 12 with the optional index signal input on pin 13. This feature uses hardware specialized hardware decoder and can handle even higher frequencies (up to 5 MHz with digital filtering disabled), but only x2 and x4 step multiplication factors are available.

Similarly as simple digital inputs, encoders can be assigned to direct key mapping or keyboard macro (only when USB connection is used). This is possible for both directions (CW and CCW) separately - the keyboard mapping of pin A is activated on positive change of the encoder value, while the keyboard mapping of pin B is activated on negative change of the encoder value.

Except for ultra-fast encoders, the encoder value can be multiplied by 1x (one 'tick'), 2x or 4x. The 4x mode increments encoder value on every signal edge and increases the resolution of the encoder for a factor of 4.



Figure 3: Encoder settings in PoKeys application

PoKeys configuration software usage

To enable encoder input on the selected pin, define the pin as digital input, switch to 'Encoders/Counters' tab, select encoder index with numerical up-down selector and select appropriate encoder channel. The last step is to check the box 'Encoder'.

To assign a key combination associated with the encoder, use the same procedure as described in the 'Digital inputs and outputs' section.

Enabling fast encoders

To enable fast encoders, go to menu 'Peripherals > Fast encoders settings', then check 'Enable fast encoders' option. There are additional options for inverting the encoders' directions, disabling 4x step multiplication and enabling the index signal on pins 9, 11 and 27. If index signal input is enabled, encoder value is automatically reset on low to high index signal transition.

Fast encoders inputs are fixed to pins 1-2 for fast encoder 1, pins 5-6 for fast encoder 2 and pins 15-16 for fast encoder 3.

Enabling ultra-fast encoders

To enable ultra-fast encoders, go to menu 'Peripherals > Fast encoders settings', then check 'Enable ultra-fast encoders' option. There are additional options to enable 4x step multiplication and inverting the encoder direction. Digital filter sampling delay slider enables setting the digital filter delay parameter - leftmost position equates to no digital filtering, rightmost position equates to digital filtering with filter delay constant set to 1000 (sampling frequency reduced to less than 25 kHz).

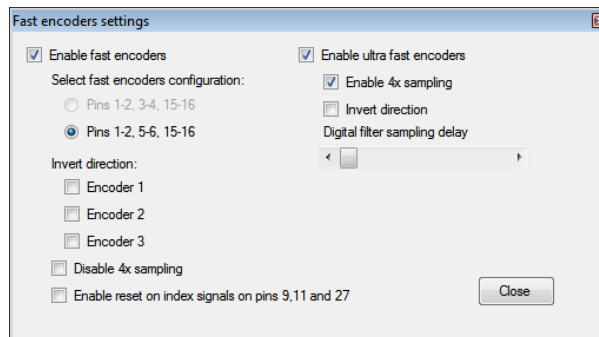

Displaying encoder raw values

To open encoder raw values dialog, go to Peripherals menu and select 'Encoder RAW values'. The following dialog below appears. It simply shows the list of all encoders and their current values. In additional column, current encoder speed is displayed.

Status of the fast encoders is displayed in green, while the status of an ordinary encoder is displayed in light grey. Inactive encoders are displayed as dark grey boxes.

At the bottom of the window, there is a command button that can be used to reset the encoders' values.

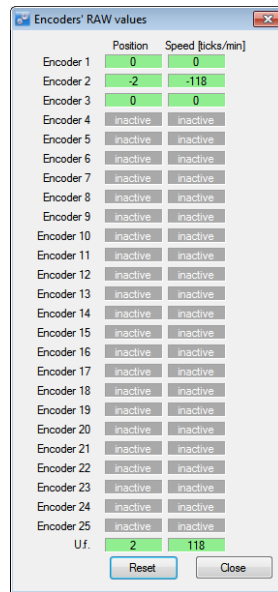

The screenshot shows a window titled "Encoders' RAW values" with a table of data. The table has two columns: "Position" and "Speed [ticks/min]". The rows are labeled "Encoder 1" through "Encoder 25", and a final row labeled "U.f.". The values for Encoder 1 are 0 and 0. Encoder 2 has -2 and -118. Encoder 3 has 0 and 0. Encoders 4 through 25 are all "inactive". The "U.f." row has 2 and 118. There are "Reset" and "Close" buttons at the bottom.

	Position	Speed [ticks/min]
Encoder 1	0	0
Encoder 2	-2	-118
Encoder 3	0	0
Encoder 4	inactive	inactive
Encoder 5	inactive	inactive
Encoder 6	inactive	inactive
Encoder 7	inactive	inactive
Encoder 8	inactive	inactive
Encoder 9	inactive	inactive
Encoder 10	inactive	inactive
Encoder 11	inactive	inactive
Encoder 12	inactive	inactive
Encoder 13	inactive	inactive
Encoder 14	inactive	inactive
Encoder 15	inactive	inactive
Encoder 16	inactive	inactive
Encoder 17	inactive	inactive
Encoder 18	inactive	inactive
Encoder 19	inactive	inactive
Encoder 20	inactive	inactive
Encoder 21	inactive	inactive
Encoder 22	inactive	inactive
Encoder 23	inactive	inactive
Encoder 24	inactive	inactive
Encoder 25	inactive	inactive
U.f.	2	118

Figure 4: Encoders' RAW values

7.4. Pulse engine

PoKeys57CNC is a hybrid device between a USB PoKeys, Ethernet PoKeys nad PoKeysCNCaddon. As such, it contains an external pulse generator on-board, which is capable of driving of up to 8 axes controlled by STEP/DIR signals with maximum pulse frequency of 125 kHz.

The pulse engine is fully configurable in terms of:

- Axis switches configuration: each switch (Limit-, Limit+ and Home/Ref) can be independently enabled, inverted and positioned either on dedicated pins (pin value of 0) or standard PoKeys pins that are listed in the device pinout
- Axis motion control configuration: each axis can be configured to optionally use an internal motion controller in either position or speed mode
- Homing/referencing procedure: motion of the reference position search can be inverted if home/ref switch is positioned in the positive end of the axis travel. The speed of the homing procedure can be configured in percents of the maximum axis speed.
- Internal motion controller parameters: such as maximum speed, acceleration and deceleration can be individually configured for each axis.
- Integrated MPG jog mode: where PoKeys can handle the MPG jogging directly - encoder index and step multiplier can be individually configured
- Other axis settings: axis enable signals, direction inversion, soft limits, etc.

See the description of the Pulse engine status/control dialog on the next page.

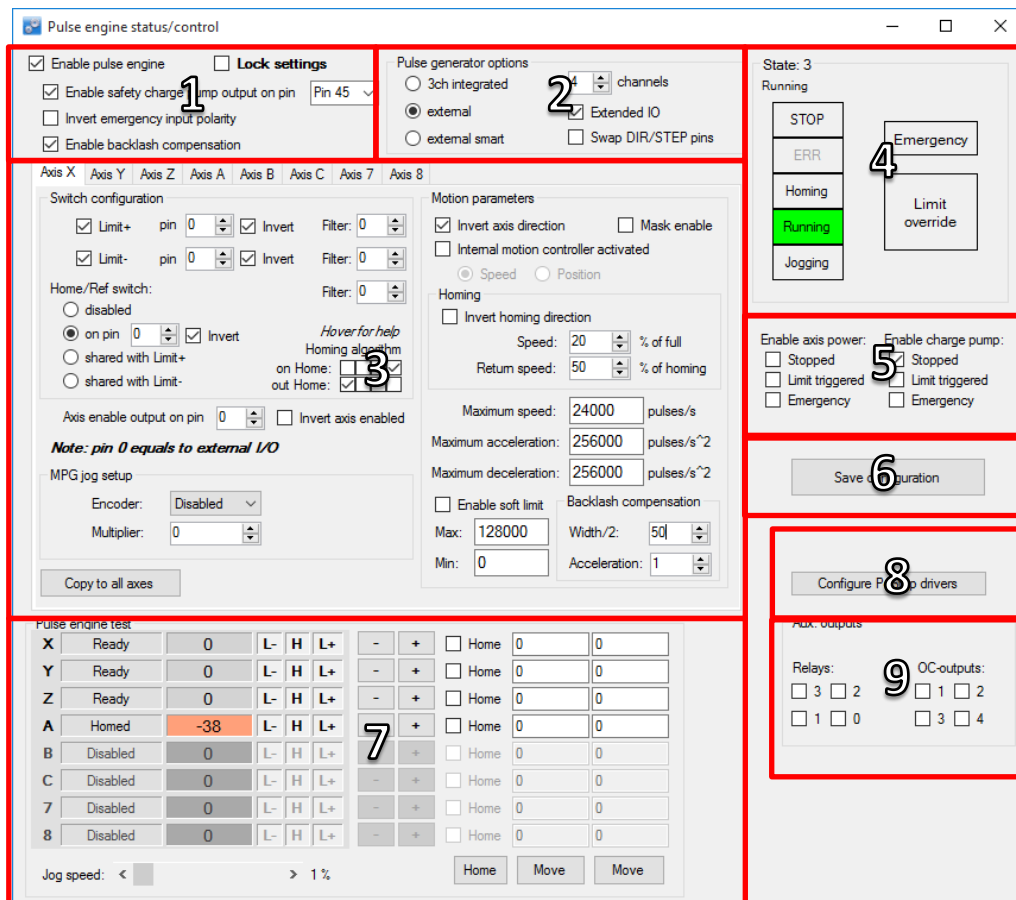

Figure 5: Pulse engine status/control dialog

Pulse engine status/control dialog parts

1. Main Pulse engine settings:
 - a. Enable pulse engine: main switch to enable or disable Pulse engine functionality
 - b. Lock: when Lock is enabled, the main Pulse engine settings and Pulse generator settings are disabled
 - c. Enable safety charge pump output: configure the pin for the charge pump output
 - d. Invert emergency input polarity: PoKeys expects NC (normally closed switch to be used as emergency switch) and HIGH signal state on emergency input indicates an emergency. If NO switch is used, the polarity of the signal must be inverted by selecting this option
 - e. Enable backlash compensation: check this option to enable the backlash compensation in PoKeys device.
2. Pulse generator options: PoKeys57CNC contains an external pulse generator on-board, thus external pulse generator option with 'Extended IO' must be selected. Up to 8 axes can be enabled
3. Axis configuration - see next page
4. Pulse engine state display and control: this panel displays current PoKeys Pulse engine state and allows the user to change between the states
 - a. STOP: stopped mode - the Pulse engine is deactivated momentarily and produces no pulses. Transition to STOP mode is instantaneous - if there is any motion being executed, the pulse generation will cease immediately after switching to STOP mode.
 - b. ERR: error mode - if PoKeys detects any event that results in error (emergency stop, limit stop, etc.), this mode will automatically be activated. As STOP mode, the transition is instantaneous
 - c. Homing: in this mode, PoKeys is executing the homing procedure. The selected axes are referenced in regards to the position of Home/Ref switch. PoKeys executes homing procedure in two steps - in first step, course position of the switch is located using faster motion in the negative direction of the axes (unless Homing direction is inverted in the settings). When the switch is located, the fine position of the reference position is located using slower motion in the positive direction of the axis (again, if not inverted in the settings) until the Home/Ref switch is released.
 - d. Running: normal operating mode
 - e. Jogging: jogging mode - in this mode, PoKeys Pulse engine can use the values from the encoders to directly jog the configured axes
 - f. Emergency: this field indicates whether device entered Emergency state
 - g. Limit override: switch that allows the user to activate the limit override
5. Enable axis power and enable charge pump: these options select, when the axis enable and chargepump output signals are activated (besides normal operating modes)
6. **Save configuration** button: after the settings are changes, this button must be clicked to send the settings to device and save them to the on-board non-volatile memory. Since this operation may produce interruptions in the motion, it is suggested to stop any motion before commencing configuration save.
7. Pulse engine testing panel:
8. Additional configuration options - here, additional configuration dialogs can be opened
9. Auxilary outputs: these can be used to test the on-board auxilary outputs

- a. Relays 0 and 1 control the SSR outputs
- b. Relays 2 and 3 control the on-board relays
- c. OC-outputs control the galvanically isolated open-collector outputs

Axis configuration panel

This panel contains settings for each axis.

The screenshot shows the Axis configuration panel with the following settings highlighted by numbered callouts:

- 1:** Limit+ pin (0)
- 2:** Home/Ref switch configuration (on pin 0, Invert checked)
- 3:** Axis enable output on pin (0)
- 4:** MPG jog setup Encoder (Disabled)
- 5:** Copy to all axes button
- 6:** Invert axis direction checkbox
- 7:** Homing Speed (20 % of full)
- 8:** Maximum acceleration (256000 pulses/s²)
- 9:** Enable soft limit Max (12000)
- 10:** Backlash compensation Width/2 (50)

Figure 6: Axis configuration panel

1. Limit switch configuration: individual limit switch (on axis positive and negative ends) can be individually enabled and inverted (in NO switches are used). Since PoKeys57CNC uses external pulse generator with extended IO, 0 should be selected as pin number.
2. Home/Ref switch configuration: this switch can be configured as a separate switch or shared with either Limit+ or Limit- switches. See below for Homing algorithm description.
3. Axis enabled output: pin 0 should be selected in dedicated signal pin on motor connector is to be used. The state of the signal can be inverted if motor drivers require it.
4. MPG jog setup: select encoder and multiplier factor to setup direct MPG jogging that is active in Jogging operating mode
5. Copy to all axes: all settings are copied to all other axes by clicking on this button
6. Motion configuration: axis direction can be inverted here. Optionally, internal motion controller can be activated, allowing PoKeys device to produce the motion signals based on position or speed reference setup. The 'Mask enable' option is for testing purposes and enables third-party software to enable individual axes independently.
7. Homing configuration: use these settings to invert homing direction and set the speed of the motion during homing procedure
8. Motion parameters: use these fields in case that Internal motion controller is enabled to setup the maximum speed, acceleration and deceleration values. When the value is entered

into the fields, **confirm the value by pressing 'Enter' ('Return') key** - the field will change color from red to white.

9. Soft limits configuration: optionally, soft limits can be configured for each axis. When internal motion controller detects the current position has gone out of these limits, the motion is softly stopped and only motion in the out-of-limit direction is allowed.
10. Backlash compensation: PoKeys devices support backlash compensation feature. Enter the size of the backlash (in pulses) and the maximum acceleration used for compensation.

Homing algorithm configuration

PoKeys devices support customization of the homing algorithm. The algorithm is based on executing selected actions on different events:

- On Home event (home switch contact is detected) - this event happens when the machine touches and activates the home switch (configured in the options above)
- Out Home event (home switch contact is released) - this event happens when the machine backs off the switch or gets past the home switch.

On these two events, the combination of the following actions can be configured (selection boxes from left to right):

- Stop and reset the position - this action marks last position as home position and commands the motion to stop. It also finishes the homing procedure for the axis
- Arm the encoder index for stop - this action arms the encoder index input for the selected axis. On the next encoder index signal, the position of the axis is marked as home, axis is commanded to stop and the homing procedure for the axis is finished. Fast encoders index inputs 1, 2, 3 (pins 9, 10 and 11 on PoKeys57CNC and 9, 11 and 27 for other PoKeys devices) are used for axes 1, 2, 3, while ultra fast encoder index input is used for axis 4.
- Reverse direction - reverse the homing direction
- Slow down - slow down the homing speed to the reduced speed, as configured

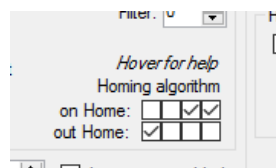

Figure 7: Homing algorithm selection boxes - default configuration (reverse and reduce speed on home and stop on home release)

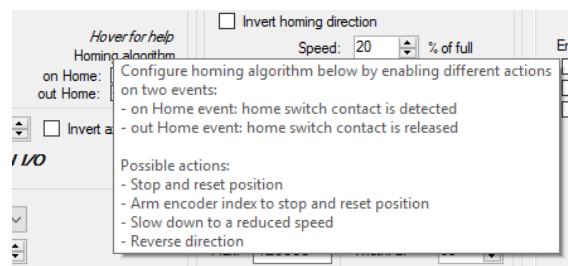
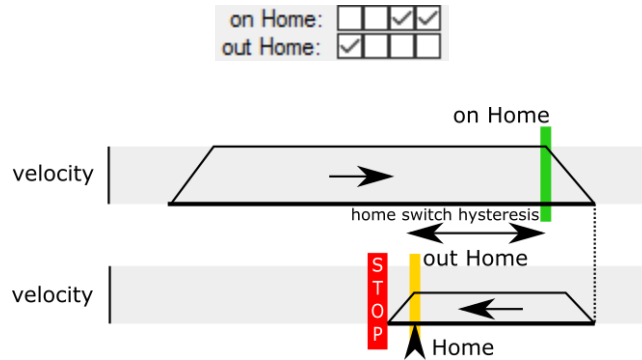

Figure 8: Built-in help

Common homing algorithm configurations

Although the homing algorithm is configurable, there are some standard configurations that fit most CNC machine configurations:

1. Standard homing configuration



2. Homing without reverse

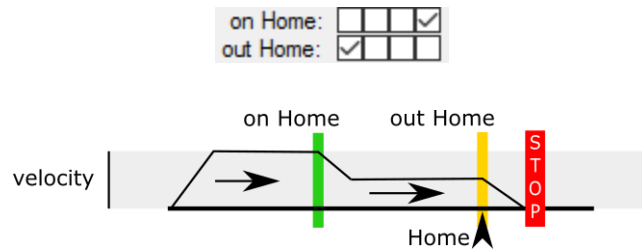

3. Homing with encoder index - standard

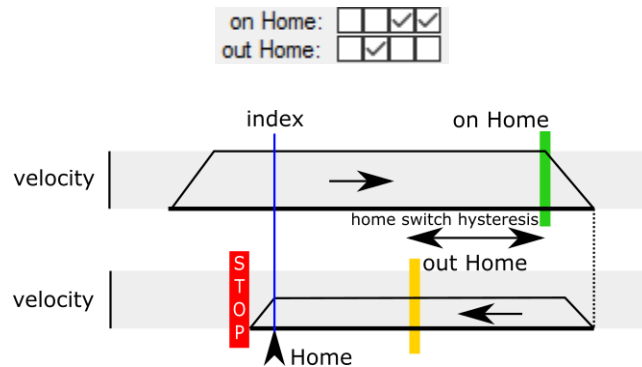

4. Homing with encoder index - without reverse

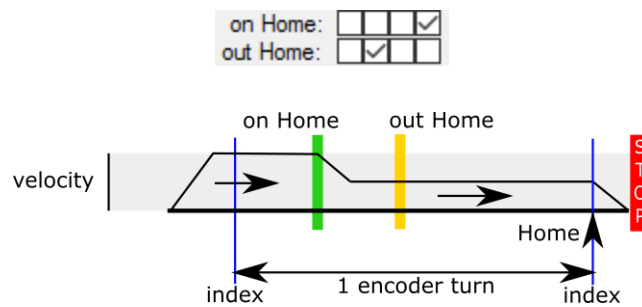

Limit and home switch filters

The limit and home switch inputs support digital filtering. The filter value defines the minimum time for the limit or home switch signal activation (1 unit equals to 100 μ s = 0.0001 s) - possible values are between 0 (no filtering) to 254 (25.4 ms).

PoStep drivers configuration

If PoStep60-256 drivers are connected with PoKeys57CNC device using PoExtension2 bus, configuration (step mode, temperature limit, motor current settings) of the drivers can be done via PoKeys57CNC device. Status of the drivers (temperature, voltage, input states, faults) can also be displayed.

In order to establish connection between PoStep drivers and PoKeys57CNC, configure unique I2C addresses to each PoStep device using PoStep configuration tool (Figure 12). PoKeys device functions as a proxy between the PC application and PoStep drivers.

Open PoStep driver configuration dialog using the 'Configure PoStep drivers' button on the Pulse engine dialog. Select one of the axes and select the I2C address for the driver (the address must be set to the value equal to what was set in the PoStep configuration tool in previous step).

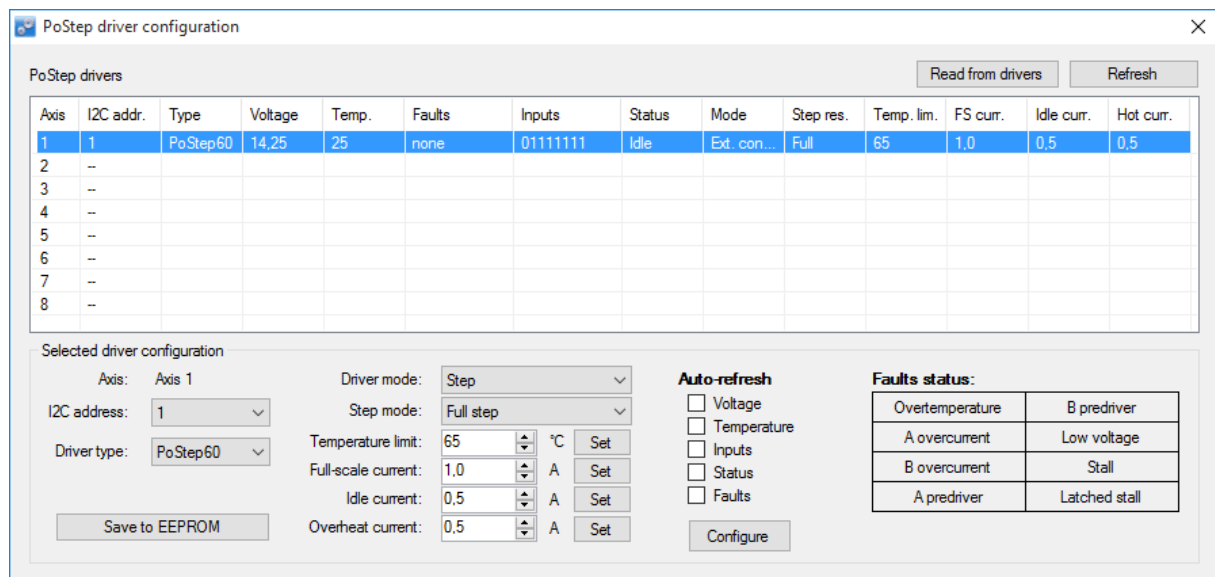

Figure 9: PoStep driver configuration dialog

The configuration dialog contains the list of PoStep drivers on the top and selected driver configuration and status at the bottom. In top right, there are buttons to retrieve settings from the PoStep device and to refresh the settings.

Once the device is configured, the driver mode, step mode, temperature limit and current settings are made available to the user. PoKeys device automatically configures the PoStep driver according to the selected values. Numeric selection settings require the user to press the 'Set' button. Although, the settings are sent to PoStep drivers, they are only valid until the PoStep device is reset - to save the settings as default startup settings, click on 'Save to EEPROM'.

Automatic refresh of PoStep status can be enabled by configuring the auto-refresh options. Select the values to refresh and click on 'Configure'. PoKeys will periodically scan through PoStep devices and retrieve their statuses.

Connecting PoStep drivers to PoKeys57CNC

Connect PoStep drivers (PoStep60-256) in parallel with PoKeys57CNC device using PoExtension2 bus. All connectors on the PoExtension2 bus must be crimped in parallel to each other (take care of the connector polarity) - see pictures below.

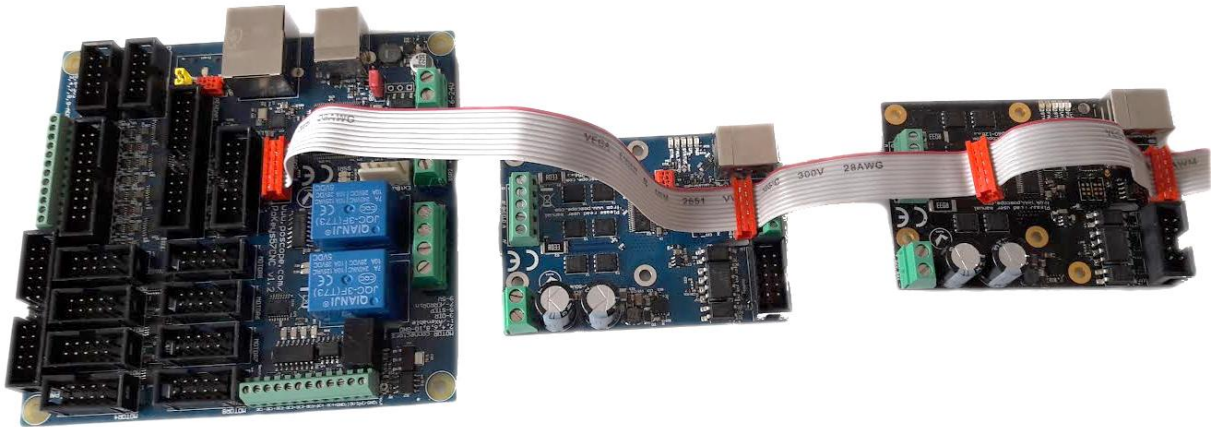

Figure 10: Two PoStep60-256 stepper motor drivers connected to PoKeys57CNC device

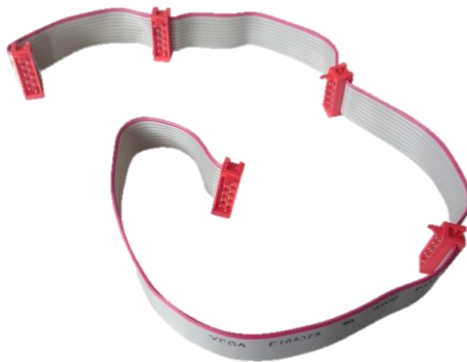

Figure 11: PoExtension2 cable for connecting PoStep drivers with PoKeys57CNC device

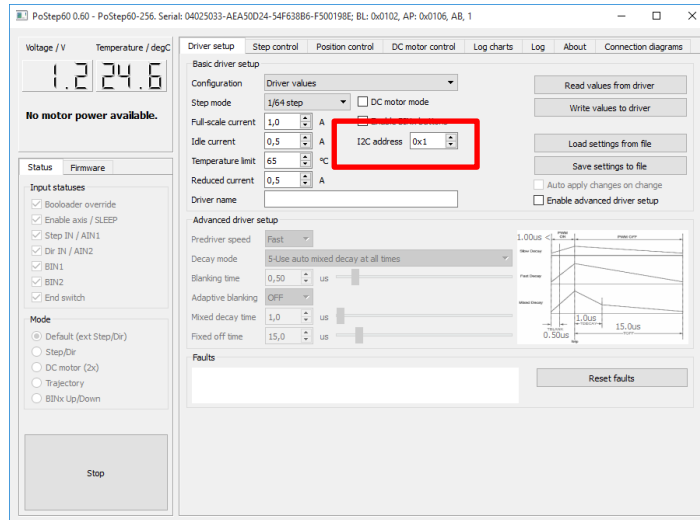

Figure 12: I2C address configuration in PoStep configuration tool

7.5. Matrix keyboard

Matrix keyboard is a set of buttons, connected into a mesh. All buttons in a row share one contact, same goes for each of the buttons in the column. If a button is pressed, a key press is detected with a periodic scanning of each of the rows and columns. PoKeys devices use digital outputs for setting the voltage levels on rows and read column voltage levels using digital inputs that already have internal pull-up resistors, so no external circuitry is needed.

PoKeys devices support matrix keyboards of up to 16x8 in size, simpler 3x3, 4x3, 4x4 and others are of course fully supported.

Similarly to simple digital inputs, keys of the matrix keyboard connected to the PoKeys device can be configured as USB keyboard keys. Direct mapping, mapping to macro sequence and triggered mapping are all supported. Additional alternate function can be used to assign two different keyboard keys to each of the matrix keyboard buttons. If additional (and freely selectable from the list of digital inputs) Fn+ input pin is inactive, the default function key is used. If the Fn+ key input pin is activated, an alternate function key is used instead of the default.

On all devices, the status of key presses of the matrix keyboard can be read using the PoKeys library commands without the need to setup the mapping described above.



Figure 13: Standard 4x3 matrix keyboard

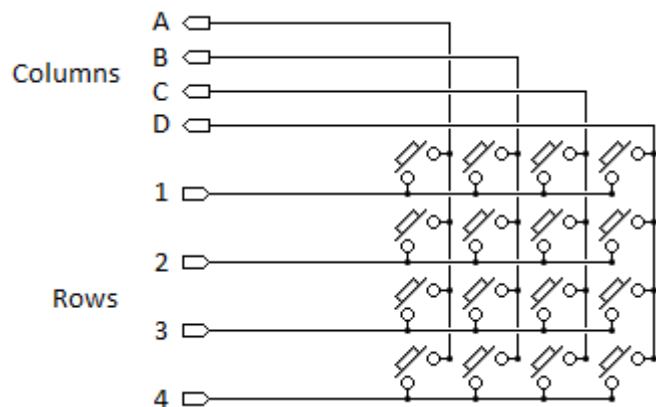

Figure 14: 4x4 matrix keyboard internal structure

PoKeys configuration software usage

Before any matrix keyboard configuration can be done, go to 'Peripherals > Matrix keyboard...', check the 'Enable matrix keyboard' option and select the number of rows and columns. Close the dialog and continue by selecting column and row pins.

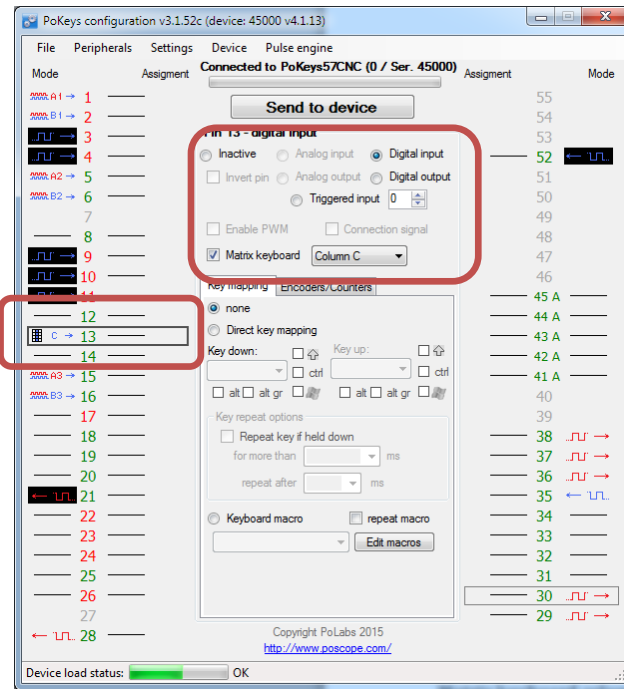

Figure 15: Assigning row and column pins

Matrix keyboard column selection

Each free digital input pin can be assigned as matrix keyboard column input. Make sure the selected pin is configured as digital input, then check the 'Matrix keyboard' option for the pin and select the appropriate column letter from the list.

Matrix keyboard row selection

Each free digital output pin can be assigned as matrix keyboard row output. Make sure the selected pin is configured as digital output, then check the 'Matrix keyboard' option for the pin and select the appropriate row number from the list.

Keyboard mapping configuration

Open the 'Peripherals > Matrix keyboard...' menu for configuration of the keyboard mapping. Matrix keyboard is schematically drawn in the dialog below. On the right, key mapping settings can be selected. To setup mapping, click on one of the keys in the matrix keyboard drawing and select appropriate key mapping options on the right.

To test the matrix keyboard, first make sure that the settings have been saved to device (close the Matrix keyboard dialog and click on 'Send to device' button). The matrix keyboard dialog can then be used to test the matrix keyboard – just press any key on your matrix keyboard and the appropriate button in the matrix keyboard drawing will be highlighted.

To setup different key presses for 'key press' and 'key release' events, check 'Triggered mapping' option and select different settings for 'Down key' ('key press' event) and 'Up key' ('key release' event).

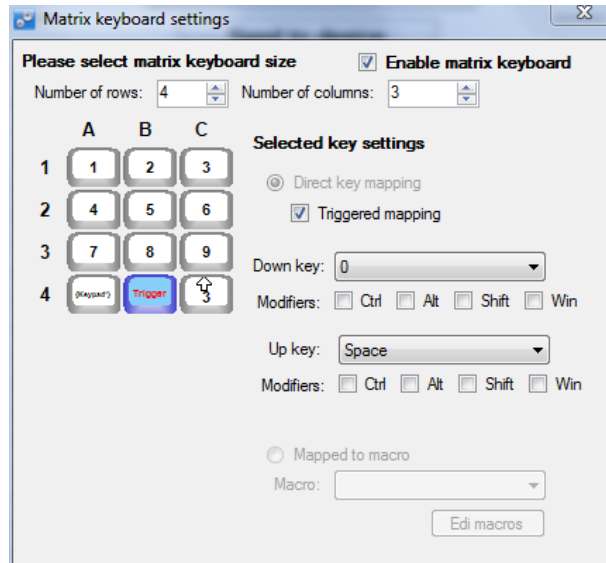

Figure 16: Matrix keyboard configuration for a 4x3 matrix keyboard

7.6. Analog inputs

Analog input function is only available on pins 41 to 45. These analog inputs can also be freely mapped to any of the 6 joystick axis; X, Y, Z, rotation X, rotation Y and throttle.

Analog inputs have a resolution of 12 bits and are sampled at a fixed rate of 10 kHz, then fed through adjustable digital low-pass filter with the following equation

$$y(k) = y(k - 1) * \frac{filter}{filter + 1} + u(k) * \frac{1}{filter + 1}$$

where $y(k)$ is the output analog value, $u(k)$ is a new A/D sample and $filter$ is a user-adjustable constant. For proper operation of the digital filter, an analog low-pass filter with a cut-off frequency of 5 kHz must be used on each analog input. The following equation gives the relation between value of $filter$ and filter's cut-off frequency:

$$f_c = \frac{10 \text{ kHz}}{2\pi * filter}$$

Sample $u(k)$ is produced according to the following equation

$$u(k) = \frac{U(k)[V]}{3.3 \text{ V}} * 4095$$

where $U(k)$ (in Volts) is a voltage present on the selected analog input pin.

PoKeys configuration software usage

To open analog inputs dialog, go to Peripherals menu and select 'Analog inputs and outputs'. Dialog below appears. To enable display of analog input channel, check the appropriate check box. It is enabled only when the input is set up as analog input.

The progress bar displays the current voltage at the pin with the maximum at 3.3V. Below the input selection boxes user can set low-pass filtering for analog inputs. When analog input signal appears to

be flickering or jumping due to analog signal noise, move the value for the filter to the right towards label 'slow signals' and then press Set button.

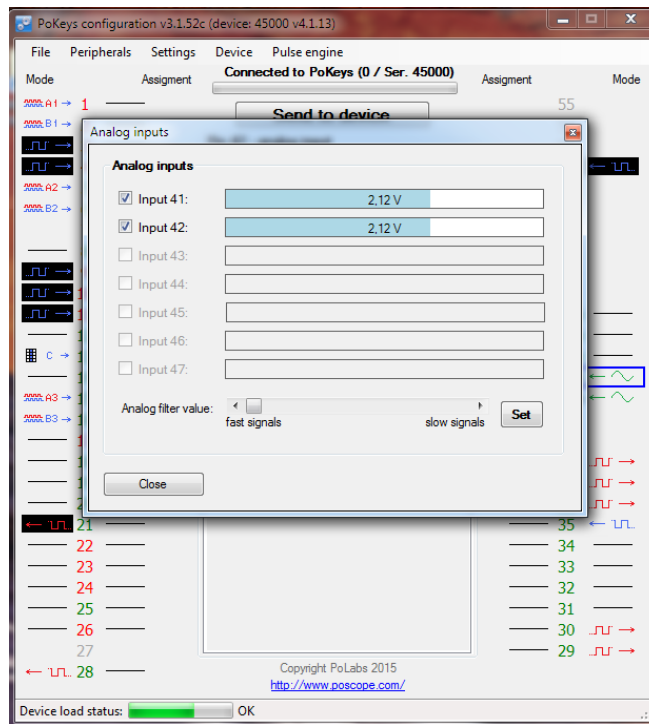

Figure 17: Analog inputs and outputs dialog

7.7. Joystick mapping

Each axis of the PoKeys virtual joystick can be assigned an analog input source. In addition, analog to digital mapping option can be enabled, which allows user to connect an analog joystick to a PoKeys devices and simulate key presses for each direction of the joystick. User can freely select dead band and saturation ranges.

Besides mapping the analog inputs to virtual joystick axes, digital inputs (or encoder switching events) can be mapped to any of the 32 virtual joystick buttons (either directly or 'triggered') or 4-way POV hat selector. The triggered mapping to joystick buttons enables used to select different pins that triggers selected joystick button on off-to-on transition (Down Event) and on on-to-off transition (Up Event).

PoKeys configuration software usage

Joystick axis and buttons mapping can be setup via Joystick mapping dialog. Go to 'Peripherals' and select 'Joystick settings...'. The dialog on Figure 18 appears.

Each axis can be assigned an analog input. In addition, analog to digital mapping option can be enabled. This allows user to connect an analog joystick to a PoKeys devices and simulate key presses for each direction of the joystick. To do so, first check 'Map to key' option. Then set the dead band (when input value will be between lower and upper dead band margins, no keys will be activated) using sliders. In the lower part of the window, select the mapping options.

For simple direct mapping (pin input status is directly reflected in joystick button status) use the ‘Direct mapping’ option and select pin number to be associated with selected joystick button. If more advanced behavior is needed (joystick button is pressed for a short time only on transitions of pin status), user should select ‘Triggered mapping’ option to select one pin that triggers selected joystick button on off-to-on transition (Down Event) and one pin that triggers this joystick button on on-to-off transition (Up Event).

If joystick button mapping is to be used in connection with encoder inputs, use ‘Triggered mapping’ option (encoder’s values cannot be directly translated into direct mapping) and select a pin with the appropriate encoder channel. For example: pins 5 and 6 are set up as digital inputs with encoder (channel A on pin 5 and channel B on pin 6). When pin 5 is selected as Down event pin for joystick Button 2 and pin 6 is selected as Down event pin for joystick Button 3, rotating the encoder in positive direction will trigger joystick Button 2 on each detent. Similarly, rotating the encoder in negative direction, joystick Button 3 will be triggered on each detent. Up Event pin option cannot be used in connection with encoders.

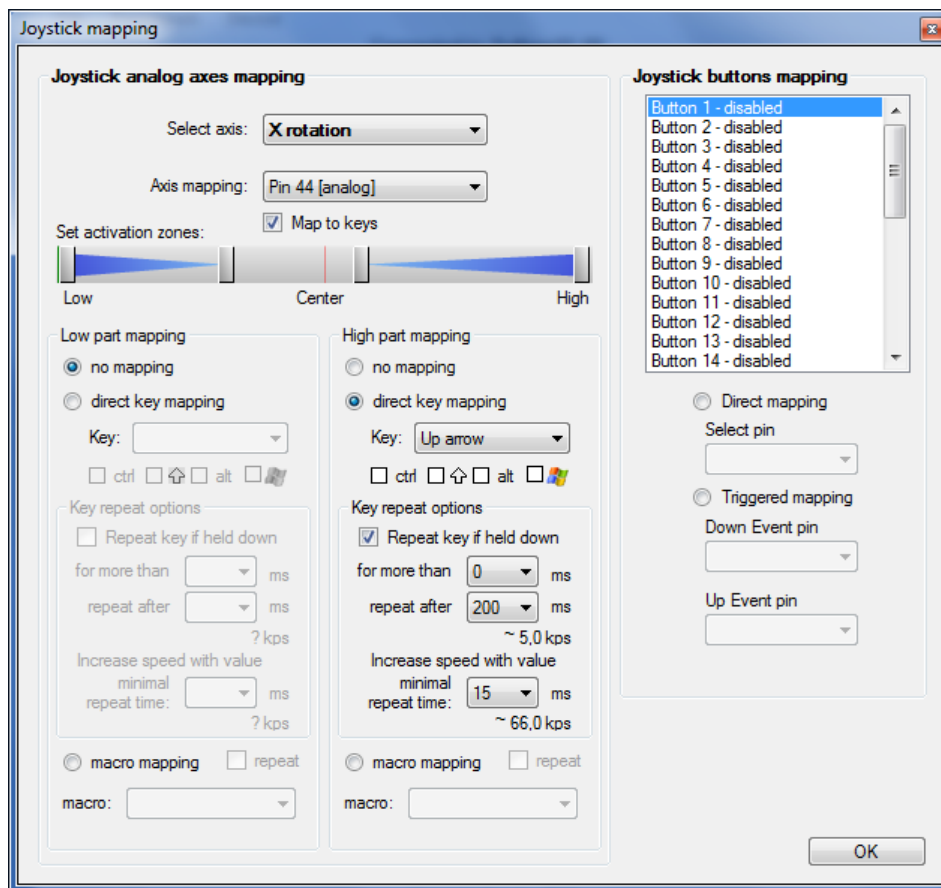

Figure 18: Joystick mapping settings

7.8. PWM outputs

PoKeys57CNC device supports PWM output function on 4 pins (pins 18, 20, 21 and 22). Different duty cycles can be assigned to each PWM output however, all outputs share the same PWM period. PWM outputs can be easily amplified using an external transistor and used for control of loads with

increased current demand - pins with such function embedded are marked as OC (open-collector) in the pinout diagram. PoKeys PWM outputs can also be used to drive various R/C servo motors that accept PWM signal with 50 Hz frequency (20 ms PWM period) and duty cycles between 5 and 10 % (1 to 2 ms).

PoKeys devices have an in-built PWM module that operates at a fixed clock frequency (25 MHz). Both the PWM period and the PWM duty cycles must be expressed as number of module clock cycles (i.e. 20 ms PWM period equates to $0.020 \times 25\,000\,000 = 500\,000$).

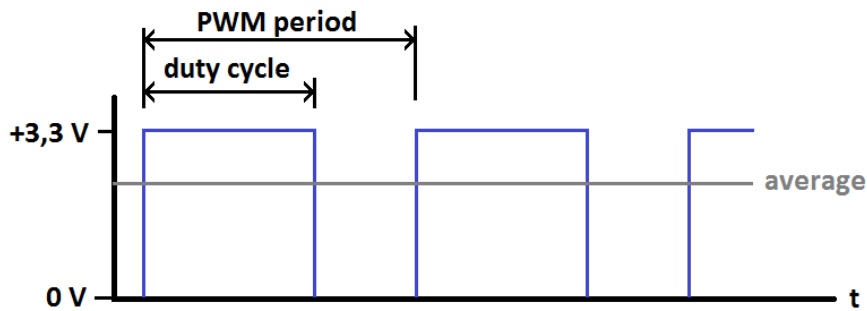

Figure 19: PWM output

PoKeys configuration software usage

PoKeys device's PWM (pulse width modulation) module can be setup via Peripherals > PWM outputs....

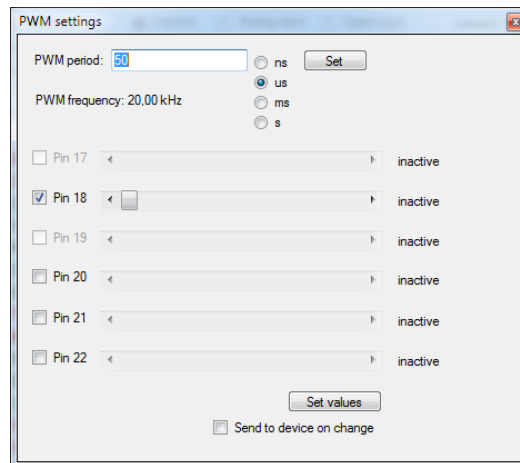

Figure 20: PWM outputs settings

In this window, user can enter PWM period and set PWM duties for each channel. Channels can be independently enabled or disabled. After a change is made, user must click 'Set values' button or check 'Send to device on change' checkbox. Left position of a slider means 0% and right position 100% respectively.

7.9. LCD

PoKeys devices support connecting one alphanumeric LCD module up to a size of 4x20 (4 rows, 20 columns). The selection of the module is limited by support for HD44780 or compatible chipset. Usually these displays come in various sizes - 1/2/4 line with 8/16/20 characters and colors (black letters on green background, white letters on blue background ...).

PoKeys57CNC device has a dedicated connector for such LCD displays - see the pinout section of the manual for connector pinout description.



Figure 21: Typical 2x16 character LCD

LCD display can be used to display various data. A third-party application or a script can execute all supported operations, including LCD initializing, clearing, moving cursor, setting display shifting mode, custom character defining and displaying text.

PoKeys57CNC devices by default function in buffered LCD mode. In this mode, any LCD-related command that is sent to PoKeys device is first buffered and when possible, PoKeys device executes the LCD refresh on its own. In this mode, some LCD operations are not operational – cursor movement is controlled by the PoKeys device and cursor move or display commands may not work as expected. If this low-level control is desirable, buffered mode must be deactivated first. In other cases, it is advisable to use buffered mode in order to allow better load balancing in PoKeys devices and in the end obtain greater communication speed.

Before LCD initialization, the LCD module size (number of rows and columns) must be specified and appropriate pin assignment (primary or secondary, see the table above) must be selected. Secondary pins must be selected in case of matrix LED display 2 in use.

PoKeys configuration software usage

Functions of this interface can be tested through PoKeys settings application. Just open Peripherals > Test LCD... and dialog below will appear.

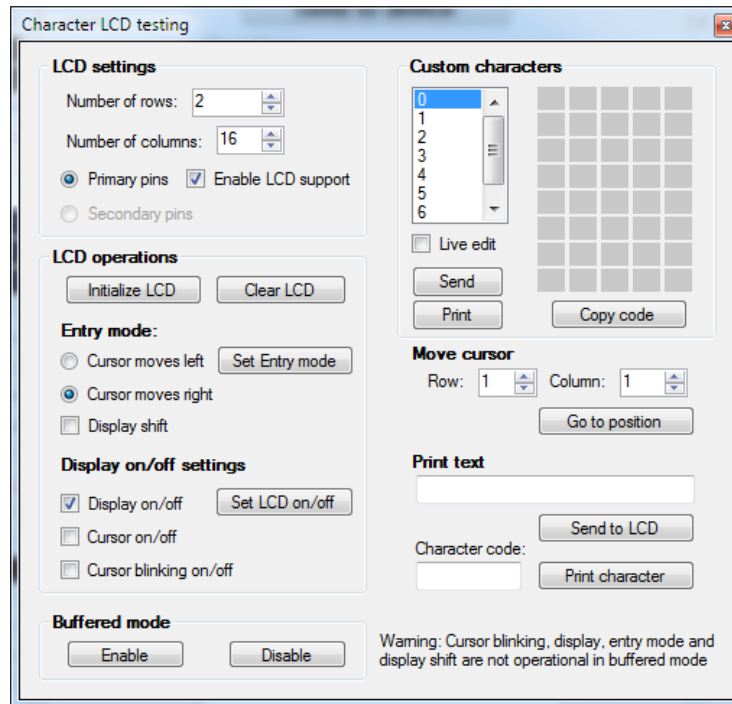

Figure 22: Character LCD testing dialog

LCD settings

In this part, user can set number of rows and columns in the LCD used. Support for LCD can be enabled or disabled also.

LCD operations

Before user can start using the LCD, LCD module must be initialized. This is done via 'Initialize LCD' button. Button 'Clear LCD' clears LCD display and moves cursor to home position. LCD module is initialized automatically by PoKeys device on device startup if 'Enable LCD support' option is enabled.

User can also set entry mode settings of LCD module. Cursor can be set-up to move either right (normally) or left after each character displayed. If 'Display' shift is enabled, whole display shifts with every new character displayed.

Settings are processed after user clicks button 'Set Entry mode' and work only in 'unbuffered' mode described above.

Display on/off settings

User can set on/off switches for whole display, cursor and cursor blinking.

Settings are processed after user clicks button 'Set LCD on/off' work only in 'unbuffered' mode described above.

Custom characters

Simple interface enables to draw up to 8 custom characters. These characters can then be used on display. Selecting 'Live edit' mode will transfer the character each time a change is made to any of the pixels. Character can be previewed via button 'Print', which puts current custom character on the LCD display. The 'Copy code' button can be used to export the character data in a form of C-style array, as shown in the table below.

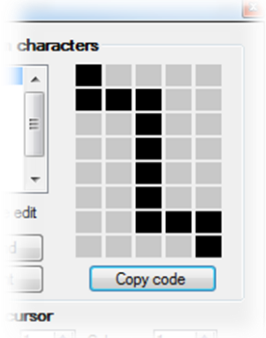
LCD custom character editor	Produced code
	<pre> unsigned char uCustomChar[8] = { 0x10, 0x1C, 0x04, 0x04, 0x04, 0x04, 0x07, 0x01, }; </pre>

Move cursor

This section enabled user to move cursor to any position on the screen works only in 'unbuffered' mode described above.

Print text

Sends entered text to display module. If advanced characters are needed, enter character code in lower text box and press 'Print character'.

7.10. PoExtBus

PoExtBus bus support enables user to add additional ten 8-bit shift registers to add up to 80 additional digital outputs to PoKeys device.

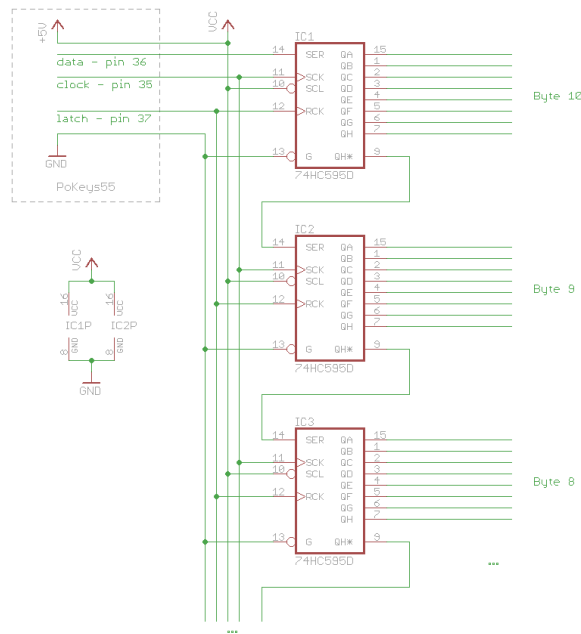

Figure 23: PoExtBus outputs chaining

PoKeys configuration software usage

To set-up and test PoExtBus, open 'Peripherals' > PoExtBus...'. The dialog below (Figure 24) appears. By using mouse left and right clicks, user can turn on or off each of the outputs.

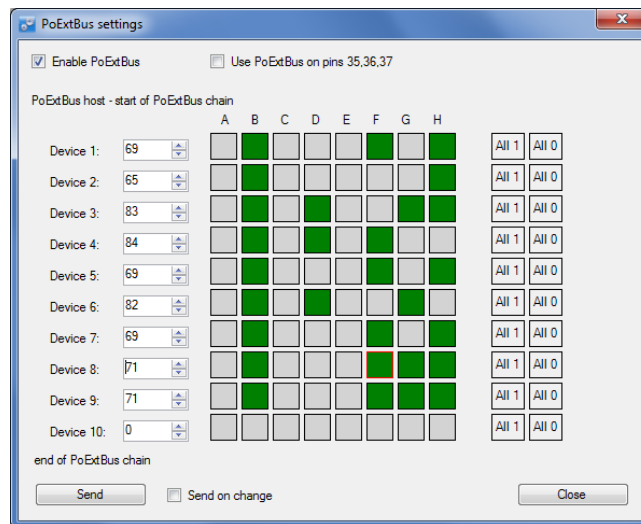

Figure 24: PoExtBus setup dialog

PoExtBus connector type

- Female wire-side connector: Molex 22-01-2055
- Cable contacts: 08-50-0032 (5 pcs needed)
- Prepared cables: 88941-0700 (5 pcs needed)

7.11. PoNET

PoKeys57CNC device supports PoNET devices (such as kb48CNC CNC keyboard).

Multiple PoNET and PoExtBus devices can be linked together. While the PoNET devices and PoExtBus devices share the same PoExtBus/PoNET connector, user should pay attention in connecting devices of both types together (see the schematics below).

All PoNET devices must be connected in parallel to each other and directly to the PoExtBus/PoNET connector, while the PoExtBus devices should be connected in series after the PoNET devices, as described below

- **PoNET devices must be connected in parallel to each other**
- **PoExtBus devices must be connected in series**
- **There should be no PoExtBus device between PoKeys device and PoNET devices**

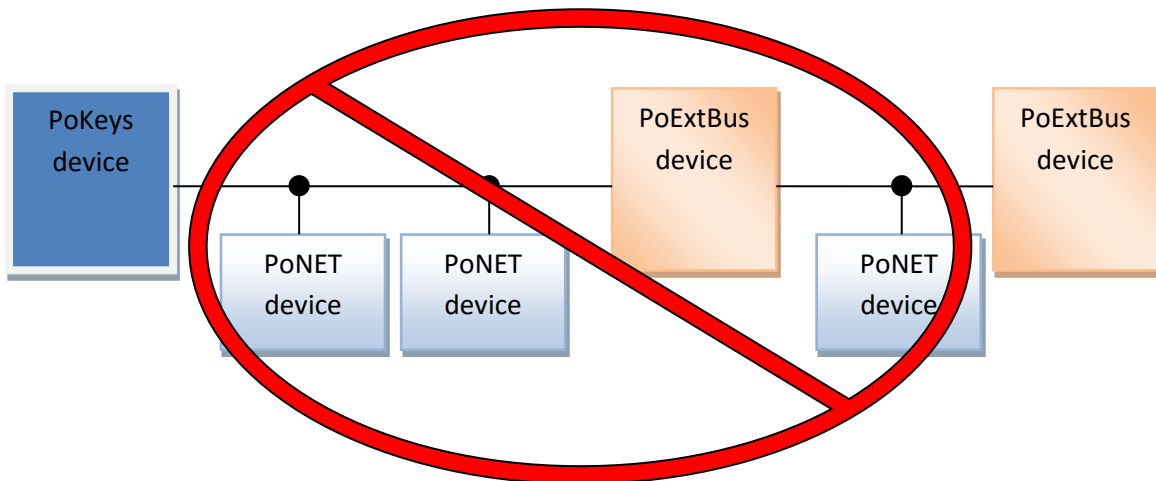
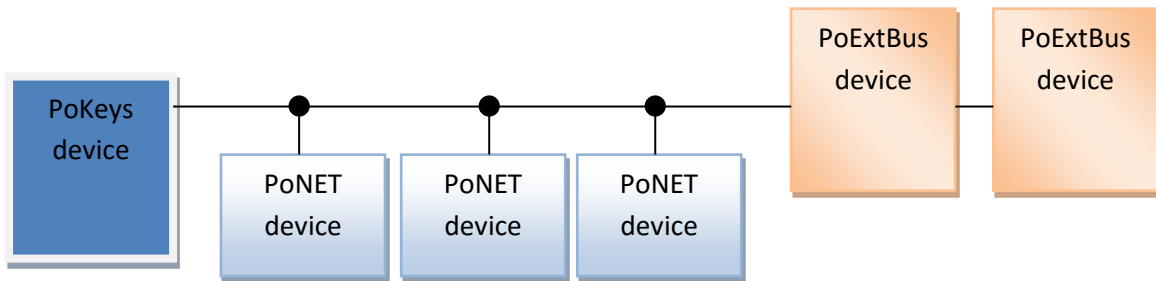

Adding new devices

After connecting new PoNET device, go to 'Peripherals > PoNET...'. The following dialog will appear

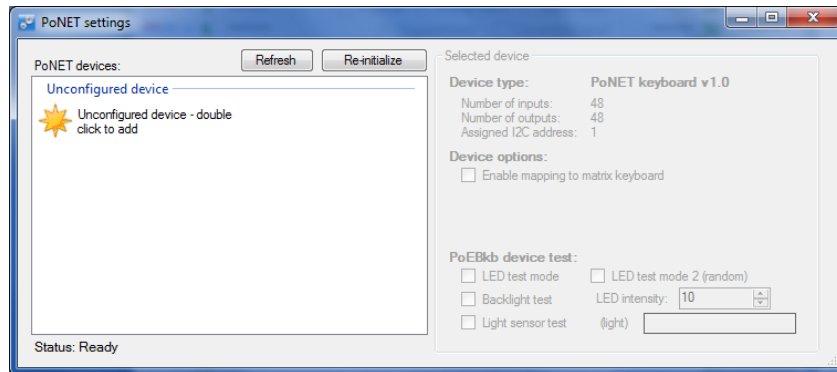

Figure 25: PoNET settings dialog with an unconfigured device

In order to register new device, double click on the 'Unconfigured device' icon. In the next 10 seconds press any key on the device that is about to be added. If the process is successful, status LED on the device will stop blinking and will be constantly lit. The device will also be listed as in the dialog below:

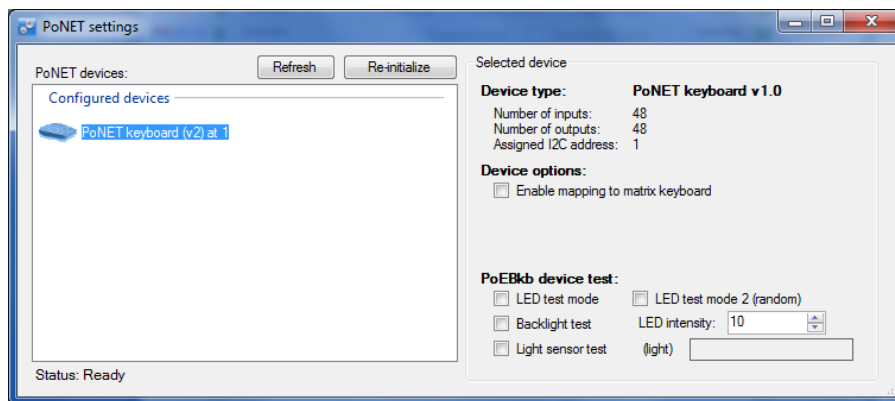

Figure 26: PoNET settings dialog with a successfully configured device

PoNET kb48CNC keyboard



The device can be virtually mapped to PoKeys matrix keyboard. Third party software can set the status of LEDs under the keys, read the light sensor that measure the amount of light in the environment and set the intensity of the LEDs.

To map the PoNET keyboard to PoKeys matrix keyboard, initialize the PoNET bus as described above in 'Adding new devices', select the keyboard in the device list and check the checkbox 'Enable mapping to matrix keyboard'.

7.12. Failsafe settings

PoKeys devices support the configuration of the failsafe state for the digital outputs, PWM outputs, PoExtBus devices and PoKeys Pulse engine.

When the communication with the device is interrupted for longer than a period defined in the failsafe configuration, peripherals listed above enter the failsafe mode, which can be setup in 'Failsafe settings' dialog (Peripherals > Failsafe settings...)

Peripheral	Failsafe setting
Digital outputs	Active Off / Active On
PoExtBus outputs	Active Off / Active On
PWM outputs	Fixed duty cycle in %
Pulse engine	No setting – Pulse engine enters emergency mode on failsafe activation

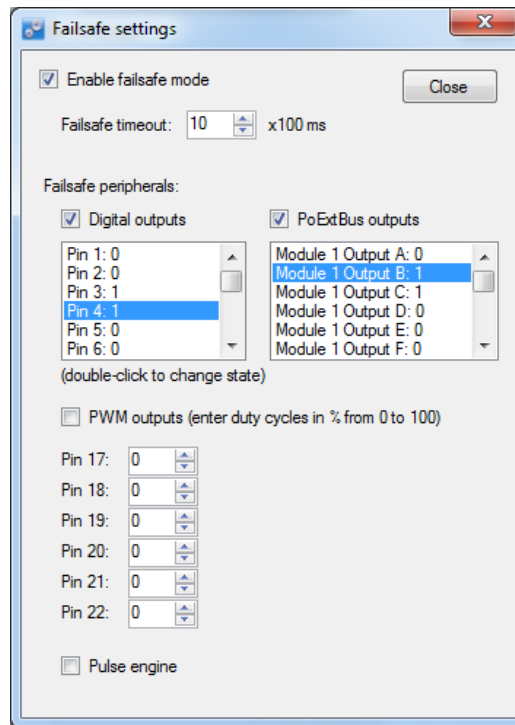

Figure 27: Failsafe settings dialog

7.13. Peripheral communication protocols

I²C protocol

The I²C bus was designed by Philips in the early '80s to allow easy communication between components which reside on the same circuit board. Philips Semiconductors migrated to NXP in 2006. The name I²C translates into "Inter IC". Sometimes the bus is called IIC or I²C bus.

PoKeys devices support communication with I²C slave devices, connected to the PoExtBus/PoNET connector. As I²C, PoNET and PoExtBus use the same connector, PoExtBus, PoNET and I²C functions are automatically switched by the PoKeys device.

Marking the pin closer to the edge of the PoKeys57CNC board as pin 1, the I²C devices should be connected as follows:

Pin 1	Power supply 5V
Pin 2	Ground
Pin 3	Serial data
Pin 4	
Pin 5	Serial clock

Protocol can be tested via PoKeys configuration software. Click on Peripherals > I²C bus test... The following dialog appears.

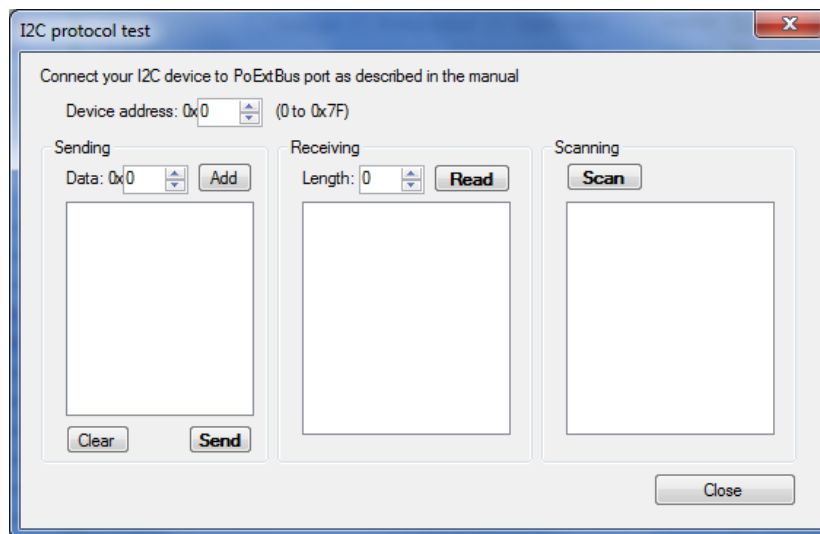

Figure 28: I²C protocol test dialog

1-wire

1-Wire is a device communications bus system designed by Dallas Semiconductor Corp. that provides low-speed data, signaling, and power over a single signal wire. 1-Wire is similar in concept to I²C, but with lower data rates and longer range. It is typically used to communicate with small inexpensive devices such as digital thermometers and weather instruments.

PoKeys devices support communication with 1-Wire slave devices (without parasitic power supply), connected to the pin 55 with external pull-up resistor (of approximately 5 kΩ).

Protocol can be tested via PoKeys configuration software. Click on Peripherals > 1-Wire bus test... The following dialog appears.

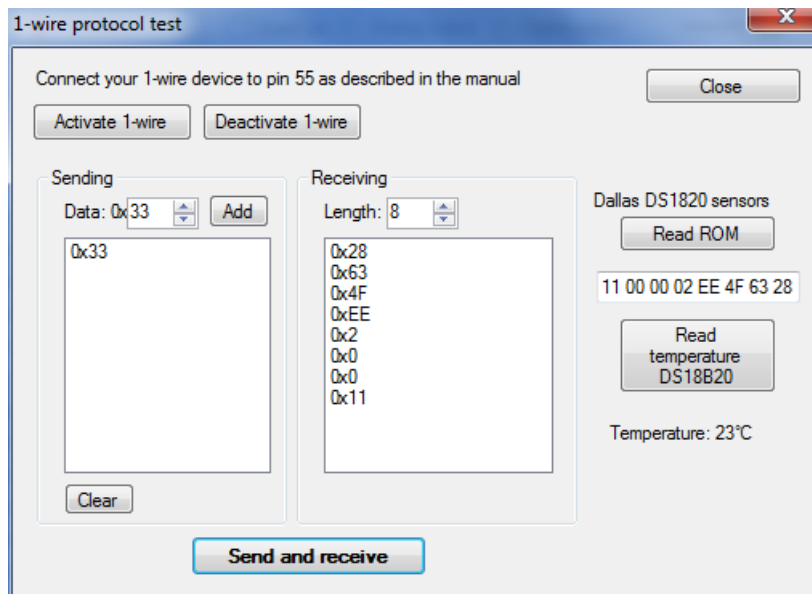

Figure 29: 1-Wire protocol test dialog

7.14. EasySensors

PoKeys57 series devices implement a feature called EasySensors. It is an improvement of the original support for various sensors in PoKeys56 series devices. EasySensors feature allows the user to setup up to 100 sensors on various communication buses (including I²C, 1-wire, DHTxx 1-wire and analog inputs). The feature is accessible in Peripherals > EasySensors menu.

EasySensors configuration dialog

The main EasySensors configuration dialog contains a list of all configured sensors with corresponding sensor information. Here, the sensory type, reading and refresh rate can be changed.

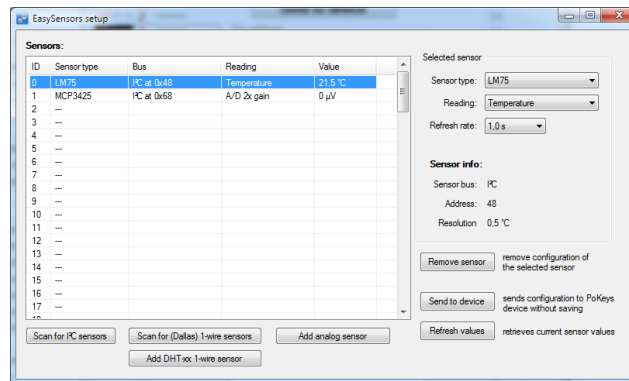

Figure 30: EasySensors configuration dialog

The changed sensor entries are marked with red color - in order for the changes to take effect, click on 'Send to device' button, which transfers the EasySensors configuration to device (note that this action does not save the settings to device's non-volatile memory and 'Send to device' on main PoKeys configuration window must be clicked to do that).

There are 4 types of sensors supported and each type of sensor can be added by clicking a corresponding button at the bottom of the dialog.

Scan for I²C sensors

This command opens the 'Add I²C sensor' dialog, which is automatically populated with detected I²C devices and sensor type suggestions. Sensor type, reading and refresh rate can be changed using the selections on the right part of the diagram. In order to add the configuration of I²C sensor, check the corresponding item in the detected I²C devices list and click on 'Finish'.

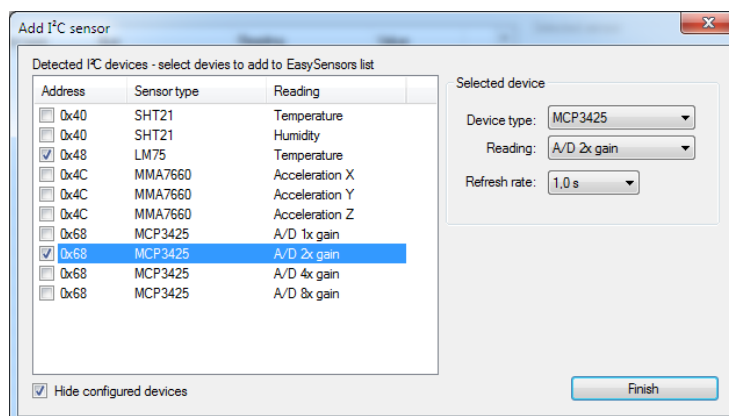

Figure 31: Scanning for I²C sensors

Scan for 1-wire sensors

The command opens the 'Add 1-Wire sensor' dialog that allows the user to select PoKeys pin, where the 1-Wire bus is connected to. By clicking 'Scan', PoKeys device scans the 1-Wire bus for devices. The EasySensors 1-wire bus implementation can detect multiple 1-Wire devices on the bus at once and thus simplifying the configuration process.

The list of available devices is then shown in the 'Detected devices' list (if 'Hide configured devices' option is selected, already configured 1-Wire devices are not displayed in the list). On the right side, reading type and refresh rate of the selected sensor can be configured.

To add the sensor to the EasySensors list, check the checkbox of the sensor in the list and click 'Finish'.

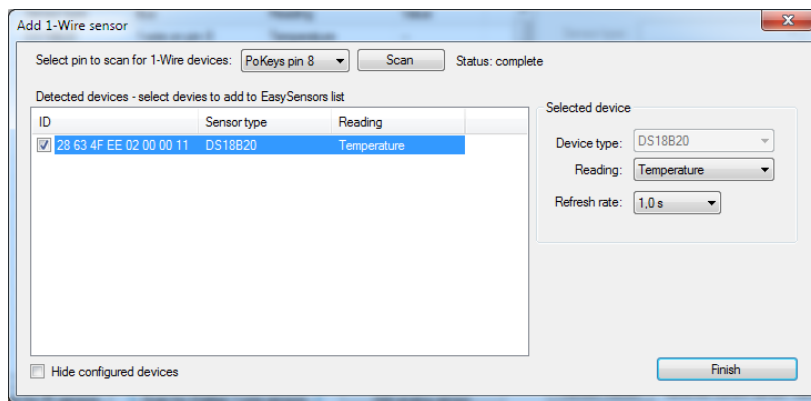

Figure 32: Scanning for I²C sensors

Add DHTxx 1-Wire sensor

Three types of DHTxx 1-Wire sensors are supported by PoKeys device (sensors differ in temperature and humidity resolution and accuracy). Any of the available PoKeys pins can be selected as DHTxx 1-Wire bus, but only one sensor can be connected per pin.

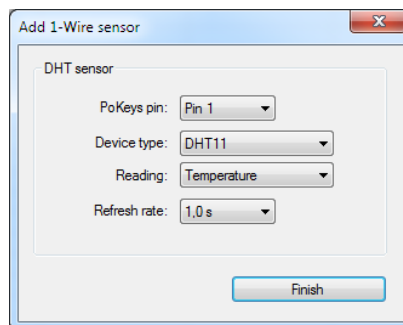

Figure 33: Adding the DHTxx 1-Wire sensor

Add analog sensor

EasySensors feature supports reading of simple analog sensors connected to PoKeys analog inputs. A linear transformation is applied to analog input reading to produce the sensor value. There are two possible ways to set up the sensor

- a) Using gain and offset: specify the gain and offset characteristics of the sensor. The gain specifies the number of sensor units per 1 V of analog voltage, while the offset specifies the sensor value of analog voltage input of zero.

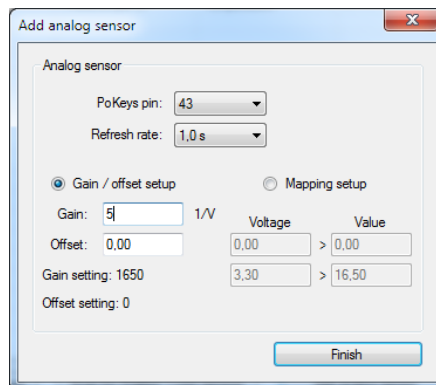

Figure 34: Analog sensor setup with gain / offset option

- b) Using two point mapping: in this mode, two sensor values with corresponding analog voltage must be entered into the fields provided. Gain and offset of the sensor are automatically calculated.

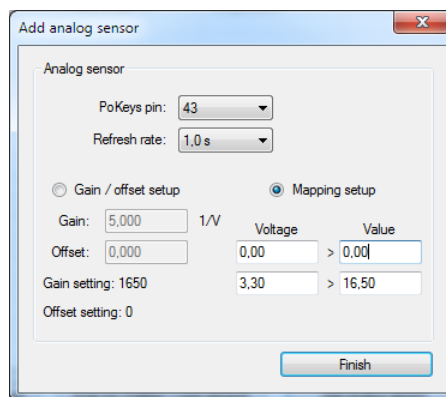

Figure 35: Analog sensor setup with mapping

Analog sensors use the following formula to convert the analog input voltage into sensor reading

$$u = AD_{val} * \frac{A_{gain}}{4096} + A_{offset}$$

where AD_{val} is a measurement of the analog-to-digital converter (a value between 0 and 4095), A_{gain} is gain (32-bit integer number) and A_{offset} is result offset (32-bit integer number). The value of u is a integer number that gets divided by 100 for the display (the temperature of 15.58 °C is represented by $u = 1558$). A gain of 330 therefore gives the true voltage on the analog input pin. The analog sensor dialog shows the gain and offset settings in the bottom left corner of the dialog and should not be confused with Gain and Offset setup parameters.

List of supported sensors

- LM75 (Maxim, TI, NXP) temperature sensor for the temperature range -55 °C to +125 °C with the resolution of 0.5 °C. The sensor has configurable address and up to 8 sensors can be connected.
- SHT21 (Sensirion) temperature and humidity sensor for the temperature range -40 °C to +125 °C with the resolution of 0.01 °C and air relative humidity in range 0 to 100 %.
- Si7020 (SiLabs) air temperature and relative humidity sensor
- Si1141 (SiLabs) IR and visible light intensity and reflection
- MCP3425 (Microchip) A/D converter with selectable gain
- MCP9600 (Microchip) thermocouple to temperature converter
- iAQ-Core C (AMS) indoor air quality module, measures VOC (volatile organic compound) and CO₂ levels
- MMA7660 (NXP) 3-axis accelerometer
- LIS2DH12 (ST) 3-axis accelerometer
- BH1750 (Rohm) light sensor
- BME280 (Bosch) air temperature, relative humidity and absolute pressure
- ADS1115 (TI) 16-bit 4-channel A/D converter with selectable gain (up to 16x)
- DS18B20 (Maxim) temperature sensor for the temperature range of -55 °C to +125 °C with the resolution of 0.0625 °C. As each sensor has its own unique sequence ID, up to 10 sensors can be connected to PoKeys.
- DS18S20 (Maxim) temperature sensor
- DS2413 (Maxim) GPIO inputs
- DHT11, DHT21 and DHT22 (AM2302) temperature and humidity sensors

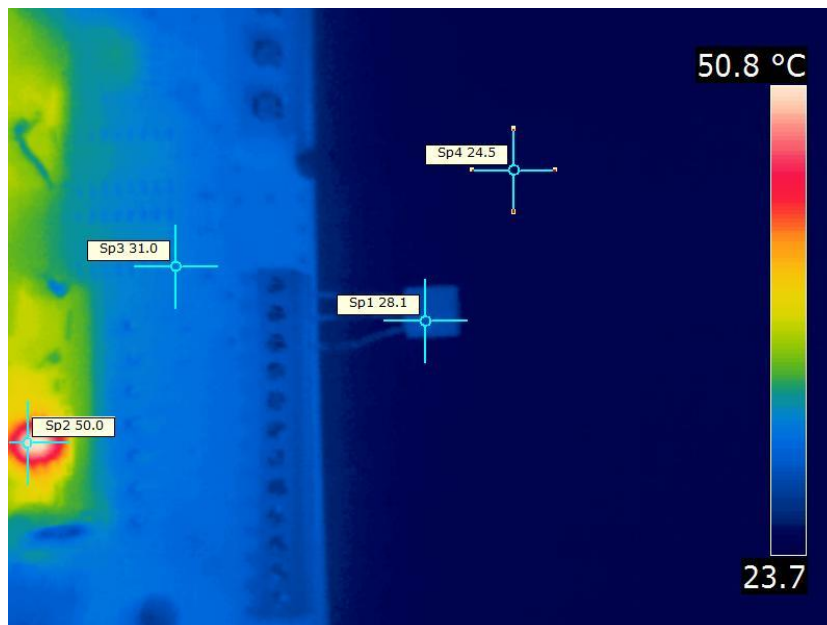

Figure 36: Thermal image of a temperature sensor being connected directly to a circuit board. The thermal conductivity of the sensor's leads causes the sensor to register higher temperature than the ambient real temperature. Use properly longer connections between sensor and sensor host board for the accurate readings

7.15. USB interface configuration

The operation of the USB PoKeys devices can be adjusted in the Device > USB interface', as shown on the figure below.

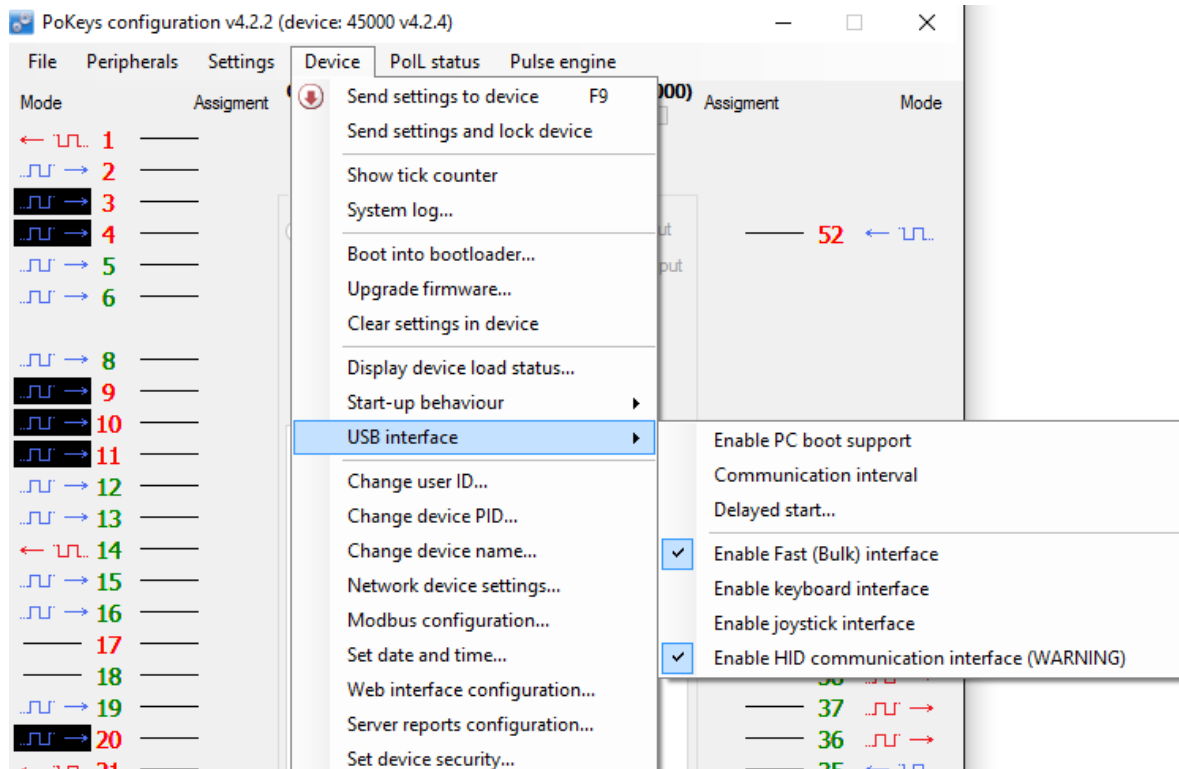

Figure 37: Accessing USB interface options

By adjusting these options, the user is given the possibility to configure how device reacts on the system start, change the communication interval and configure which interfaces are visible to the system. In some situations, omitting the unused interfaces can result in achieving better performance of the device due to lower load to the system drivers.

Start options

USB PoKeys devices can be configured to either report the support for boot operation or not. Some PC BIOS versions have problems configuring non-simple (plain keyboard and mouse) devices and may halt the boot sequence if such device is present. By omitting the PC boot support, this is usually overcome.

If this however does not fix the problems during the boot sequence, delayed start option give the possibility to delay the PoKeys device registration on USB for the predetermined delay, which will result in BIOS not detecting the device and continuing the boot sequence. Adjust the value according to your system in this case.

Communication interval

By default, PoKeys USB devices use 1 millisecond communication interval for the communication interface. If for any reason slower communication is required, it can be adjusted using the Communication interval settings dialog. Communication intervals between 1 millisecond and 20 milliseconds can be configured.

Enabling/disabling the interfaces

Each USB PoKeys device uses 4 USB interfaces (i.e. USB devices) and thus appears as 'USB Composite Device' in the Device manager. If not needed, some (or all) interfaces can be disabled.

Note: if all communication interfaces are disabled, configuration of the device will no longer be possible. In that case, follow the instructions in the section 'Restoring factory defaults' to restore the device's functionality.

7.16. Network device functionality

PoKeys57CNC device can be connected to Ethernet 10/100 network with standard RJ-45 cable.

By default, the device is set to use the DHCP functionality of the network router. User can later turn on or off the DHCP support. If DHCP is not required or available, fixed IP address must be defined for the device. To set the network settings of the device, go to Device menu and click Network device settings...

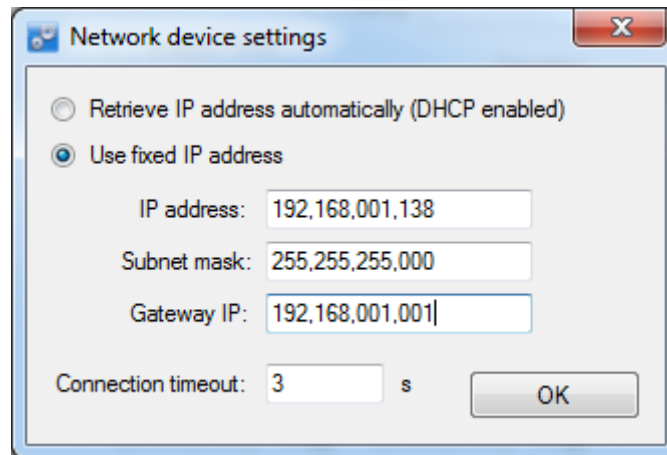

Figure 38: Device network settings

The device communicates using TCP and UDP port of 20055. **Please ensure the firewall settings allow communication with this port. Also, please make sure that your network card (which you have connected the PoKeys device to) has an IP address assigned with the subnet mask 255.255.255.0 (check it in IPv4 settings in your system).**

By default, PoKeys device is configured to close the connection with the host after 3 seconds of inactivity. This connection timeout value can be set in the dialog, shown in Figure 38.

Device discovery

Unless PoKeys device is configured with a fixed IP address or static DHCP lease option is enabled on the router, user has no direct display of what IP the PoKeys device is configured or assigned with. Therefore, PoKeys device feature an automatic discovery mechanism that uses discovery packets sent from software looking for PoKeys device and discovery response packets that PoKeys device constructs as an answer to a discovery. The discovery response packet contains vital PoKeys device information that can be used to identify and find the PoKeys device in the network.

In case the DHCP server is not available in the network or if discovery packet was received from different subnet than the one used by PoKeys device, the device will change to a temporary IP address from the same subnet (defaulting to 255.255.255.0 subnet mask) that the request was sent from. This temporary address can be recognized by ending in .250 and should only be used to find a misconfigured device and setup it with proper network configuration. The discovery process can be disabled under Device > Network device settings by clicking 'Advanced' button.

More information on this mechanism can be found in the Protocol specification document.

Default network settings

DHCP:	enabled
Port:	20055
Security:	Full access

Connecting to device in other network

When the device is not detected automatically (either there is a firewall blocking the UDP broadcast messages or the device is not in the same network as a computer), custom IP address of the device can be entered by clicking on the 'Network settings...' button on the 'Connect to device' dialog. The following dialog appears.

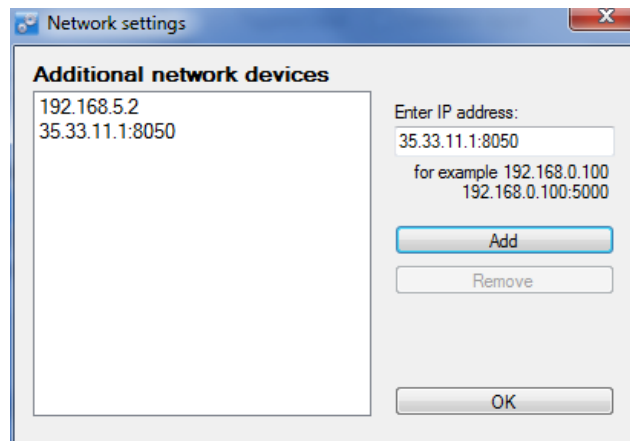

Figure 39: Additional network settings

IP address of the device can be entered in the text box on the right and added to the list by clicking the button 'Add'. The list of additional devices is saved on application exit.

Security

Due to exposed nature of a network device, an authentication mechanism was implemented in network PoKeys that allows three levels of access rights:

- Full access (default): the device is fully accessible from the network
- Read-only access: unauthorized users are allowed only to fetch a limited set of data from the device, while an authenticated users can access all functions of the device
- Full lock: unauthorised users can not neither read or write to the device. A user password is required to unlock access.

The security is set up in PoKeys configuration software – on the Device menu, click Set device security... The password can contain any character and can be up to 32 characters long.

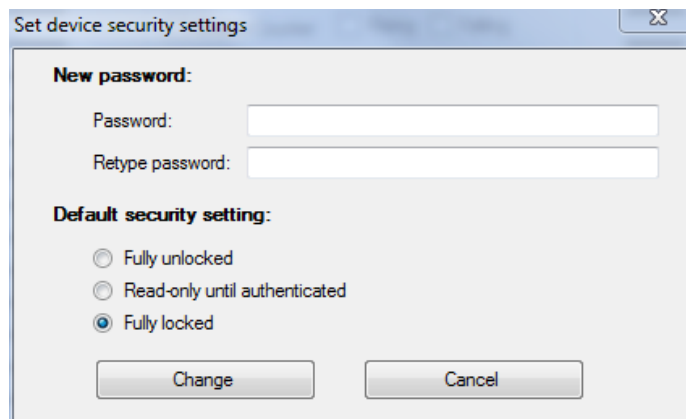

Figure 40: Device security settings window

Web interface (dashboard)

Network PoKeys devices can be monitored through the simple web interface (that is already enabled by default).

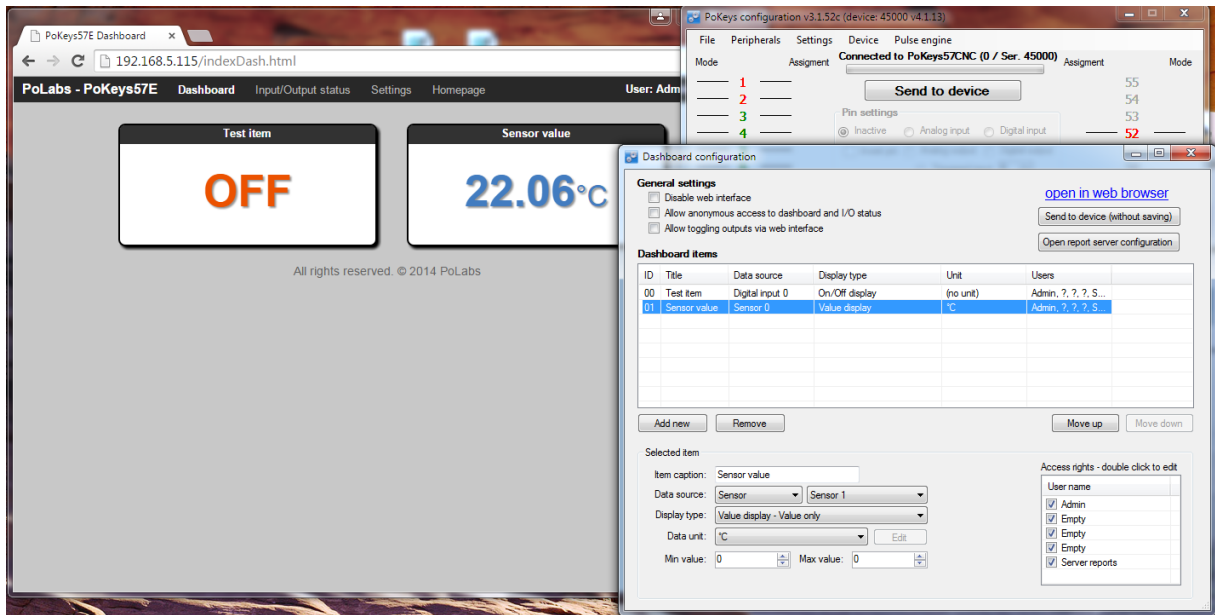

Figure 41: PoKeys device web interface

The interface can be disabled or configured in dialog accessible via menu Device->Web interface configuration. The following dialog appears

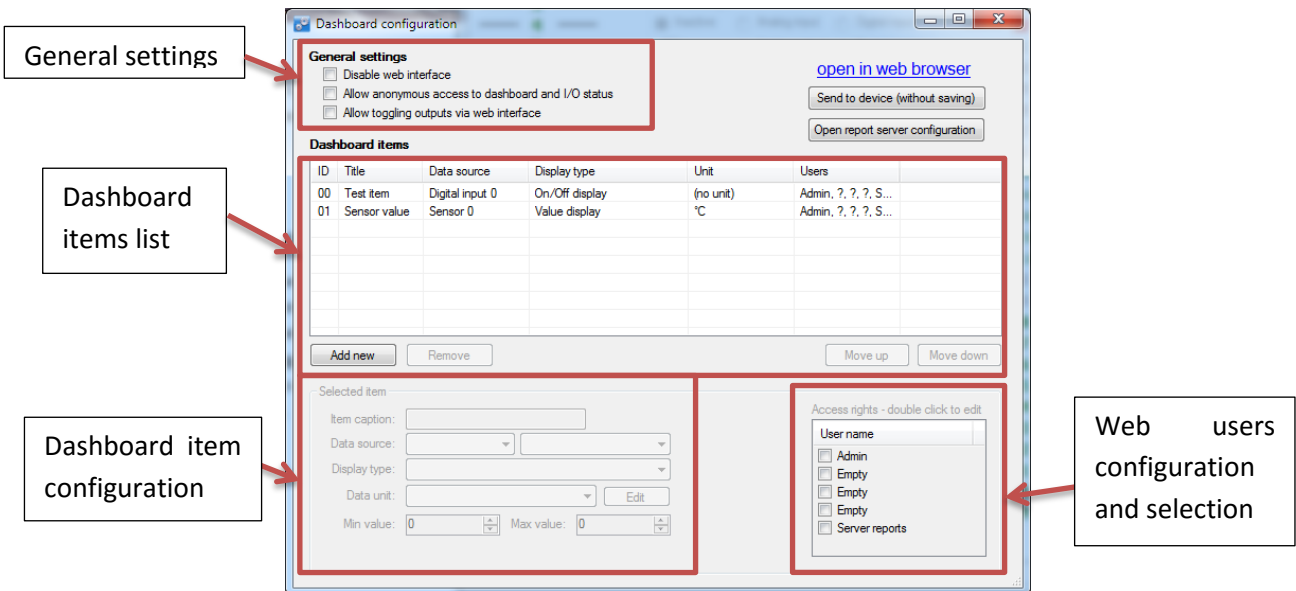

Figure 42: Web interface settings – Dashboard configuration

The dialog presents the following three options in the upper left corner:

- Disable web interface: check this field to disable web interface.
- Allow anonymous access to dashboard and I/O status: if this field is checked, users can access web interface directly without entering user name and password.

- Allow toggling outputs via web interface: if this field is checked, users can toggle the pins that are setup as outputs. If this field is unchecked, users are only presented with the status of each pin.

Dashboard items configuration

Up to 100 dashboard items can be configured. In order to add a new item, click on 'Add new' and enter the item information in the fields below ('Selected item' settings).

Selected item	
Item caption:	Sensor value
Data source:	Sensor Sensor 1
Display type:	Value display - Value only
Data unit:	°C Edit
Min value:	0
Max value:	0

Access rights - double click to edit	
User name	
<input checked="" type="checkbox"/> Admin	
<input checked="" type="checkbox"/> Empty	
<input checked="" type="checkbox"/> Empty	
<input checked="" type="checkbox"/> Empty	
<input checked="" type="checkbox"/> Server reports	

Figure 43: Dashboard item configuration

The following settings are available for each item:

- Item caption: a string of up to 13 characters describing the item (note: some web services have limitations on what characters can be used - the software will provide you with a warning if incorrect characters are used)
- Data source: select the data source from available sources (digital inputs or outputs, PoExtBus outputs, Sensors, digital counters, PoIL shared slot data) with respective index of the item from the second list
- Display type: there are different display type options available based on the data source type. The digital signals can be represented by ON/OFF value with optional On/Off or On/Off/Toggle buttons. The (analog) value signals can be represented by numeric value display with optional bar graph. The numeric value can be made editable - double-click on the displayed value shows an editor box, that allows the user to enter a new value, which is sent back to device (for use with PoIL shared data values).
- Data unit: the PoKeys device comes preconfigured with a variety of data units. If the desired unit is missing from the list, up to 20 custom units can be configured.
- Min/max value: use the minimum and maximum value boxes to set the values for the bar graph boundaries.
- Access rights: select users from the list that should have access to the selected item.

Custom unit editing

PoKeys device contains 20 custom units that allow the user to setup additional units if needed. Since the units are displayed on a dashboard in a web browser, HTML code for the unit can be entered, allowing different text formatting.

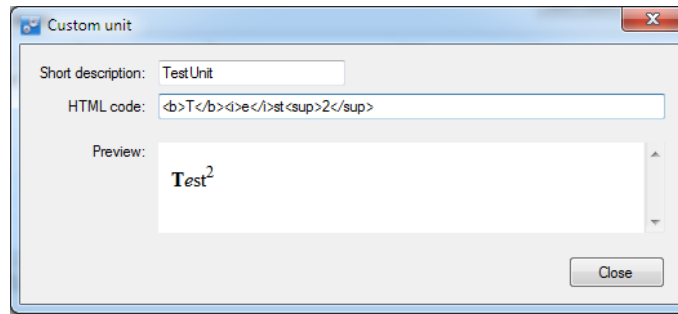

Figure 44: Custom unit editor

Managing the web user accounts

The dashboard configuration dialog contains a list of available users. To edit the user, double-click on the entry in the list - a 'User account' dialog will pop up, allowing the changes to user name and password.

By default, PoKeys contains a user named 'Admin' with password set to 'root0'. Both the username and password of this user can also be changed.

Usernames and passwords can be configured for up to 4 users with the length of each limited to 8 (ASCII) characters.

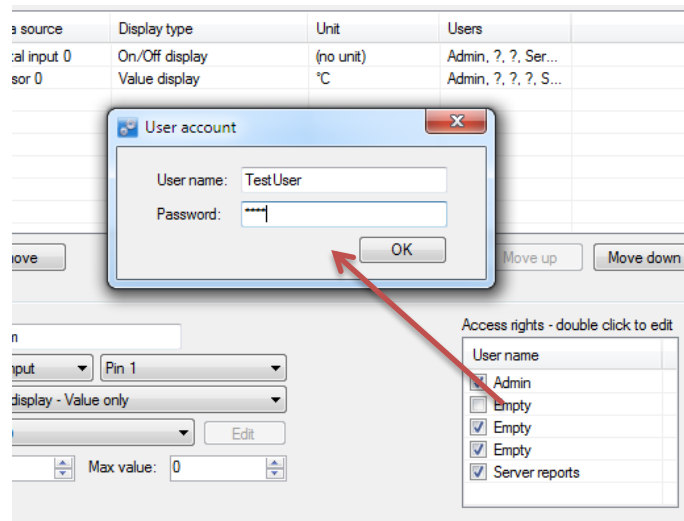

Figure 45: Editing user account

Accessing the dashboard items data

The information on dashboard items data and their values can be accessed by fetching the following files from the device:

- devStat.xml: contains values of all digital inputs and outputs, encoder values, analog inputs, sensors, PoIL shared data values and digital counters

- devData.xml: information on the PoKeys device (network configuration and some other device data)
- sensorList.xml*: contains information on dashboard items configuration and value
- sensorList.json*: same as above, but in json format
- setS.html*: is used to change the sensor value
- setDO.html: is used to change digital output value

The setS.html and setDO.html have the following syntax

http://<IP address>/setDO.html?Pin=<Pin ID>&State=<0/1/T>&u=<Username>&p=<Password>
 http://<IP address> /setS.html?Sensor=<Item ID>&State=<Value>&u=<Username>&p=<Password>

The <Pin ID> is 1-based PoKeys pin index (same as indicated on the device), while <Item ID> is 0-based dashboard item index of the current user.

Modbus

PoKeys57CNC device supports slave (server) operation of Modbus TCP communication protocol. Modbus TCP compatible devices on the network can read the values from the device and set the outputs. To elevate the security, user can define which peripherals are accessible via Modbus TCP.

Modbus TCP uses TCP protocol on port 502 (default), which can be changed in Modbus settings (accessible from the menu Device – Modbus configuration...). The Modbus TCP connection is disconnected after 3 seconds of inactivity (this default value can be changed in the Modbus settings).

Discrete inputs/outputs

Supported operations:

- 0x01: Read coils
- 0x02: Read discrete input
- 0x05: Write single coil
- 0x0F: Write multiple coils

Address (0-based)	Access (R – Read, W – Write)	Description
0-54	R/W	55 pin inputs/outputs
100-126 (100-149 on PoKeys57 series)	R	Sensor OK statuses
200-263	R/W	PoIL shared data (binary data) - overlapped with 32-bit PoIL shared data at 1000-1127 (16-bit)
1000-1127	R	Matrix keyboard inputs
1400-1527	W	I2C Matrix keyboard LED
1600-1727	R/W	LED matrix
2000-2079	R/W	PoExtBus
2000		Device 10 – Output H
2001		Device 10 – Output G
...		
2079		Device 1 – Output A

Registers

Supported operations:

0x03: Read holding register

0x04: Read input register

0x06: Write single register

0x10: Write multiple registers

Address (0-based)	Access (R – Read, W – Write)	Description
0-1	R	Serial number of the device (PoKeys57 only)
10-16	R	Analog inputs
20-45	RW	Encoder counter values (lower 16-bit)
100-154	RW	Digital counter values
200-213	RW	PWM
200,201		PWM period (MSB first)
202,203		PWM duty1 (MSB first) – pin 22
...		
212,213		PWM duty6 (MSB first) – pin 17
300-304	RW	PoExtBus
400-453 (400-499 on PoKeys57 series)	R	Sensors (32-bit values, LSB first)
500-579	RW	LCD buffer
590	W	LCD configuration (0=disabled, 1=primary or 2=secondary) - writing to this register will re-init and clear the LCD
591	W	Number of rows (lower byte) and number of columns (upper byte) of the LCD module
592	W	Not used
593	W	Clear LCD (both bytes = 0xAA)
600	R	Tick counter (lower 16-bit)
700-751	R[W]	Digital encoder values (32-bit values, LSB first) - any write to these registers causes the reset of the encoder value to 0
800-909	RW	Digital counter values (32-bit values, LSB first)
1000-1127	RW	PoIL shared data (32-bit, LSB first)

PoExtBus channel mapping:

Address (0-based)	Register description															
300	A	B	C	D	E	F	G	H	A	B	C	D	E	F	G	H
	Device 10								Device 9							
301	A	B	C	D	E	F	G	H	A	B	C	D	E	F	G	H
	Device 8								Device 7							
302	A	B	C	D	E	F	G	H	A	B	C	D	E	F	G	H
	Device 6								Device 5							

303	A	B	C	D	E	F	G	H	A	B	C	D	E	F	G	H
	Device 4								Device 3							
304	A	B	C	D	E	F	G	H	A	B	C	D	E	F	G	H
	Device 2								Device 1							

where

15	14	13	12	11	10	9	8	7	6	5	4	3	2	1	0	Modbus word bit
A	B	C	D	E	F	G	H	A	B	C	D	E	F	G	H	PoExtBus device bit mapping
Device 10								Device 9								

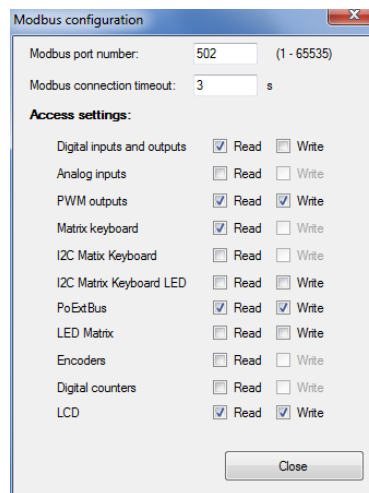

Figure 46: Modbus configuration

Reporting data to network server with PoKeys57CNC device

PoKeys57CNC devices can automatically report sensor values to various network servers using the HTTP POST, HTTP PUT or text-only protocols.

To use this reporting feature, user must specify reports type (RAW, UDP, Xively, Standard HTTP POST/PUT or custom), server IP, server port number and update rate.

Custom report type

The request header is constructed of two parts – HTML header and data header, divided by double new line character (\n). Example header (Xively.com web service):

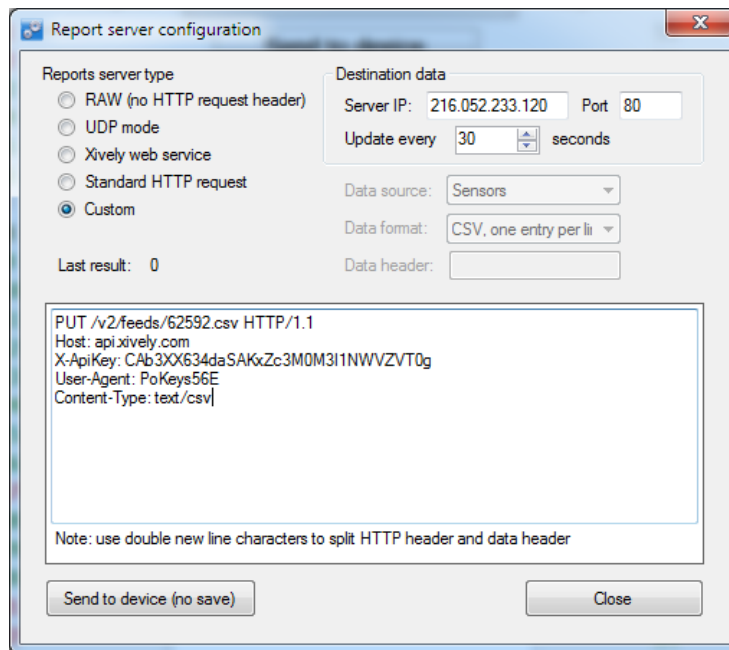

```
PUT /v2/feeds/62592.csv HTTP/1.1
Host: api.xively.com
X-ApiKey:
CAb3XX634daSAKxZc3M0M3I1NWVZVT0g
User-Agent: PoKeys56E
Content-Type: text/csv
Content-Length: 010
Connection: close

Test1234,-15000.00
```

The HTTP header without 'Connection' and 'Content-length' tags must be provided by the user

The 'Connection' and 'Content-length' tags are automatically inserted by the PoKeys device

Data is inserted at the end of the packet

The above example is specified as

```
PUT /v2/feeds/62592.csv HTTP/1.1
Host: api.xively.com
X-ApiKey: CAb3XX634daSAKxZc3M0M3I1NWVZVT0g
User-Agent: PoKeys56E
Content-Type: text/csv
```

The extra new line at the end is essential.

More customized header:

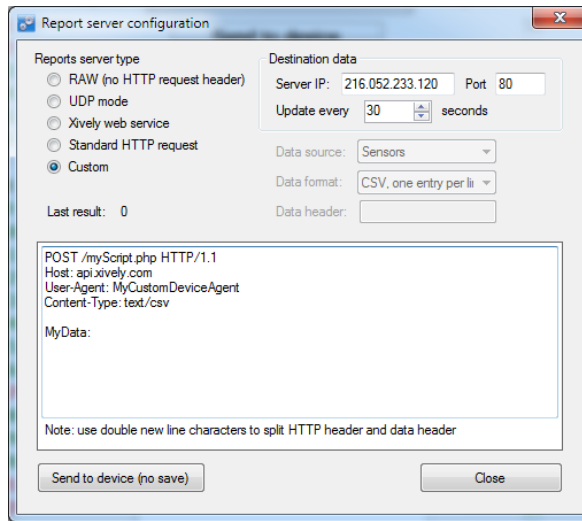

```
POST /myScript.php HTTP/1.1
Host: api.xively.com
User-Agent: MyCustomDeviceAgent
Content-Type: text/csv
Content-Length: 010
Connection: close

MyData: Test1234,-15000.00
```

The HTTP header without 'Connection' and 'Content-length' tags must be provided by the user

The 'Connection' and 'Content-length' tags are automatically inserted by PoKeys device

The above example must be specified as

```
POST /myScript.php HTTP/1.1
Host: api.xively.com
User-Agent: MyCustomDeviceAgent
Content-Type: text/csv

MyData:
```

Again, an extra new line character in fifth line is essential.

Total length of final header and data is limited to 350 bytes.

Setup for Xively web service

Xively web service is an on-line database service allowing users to connect sensor-derived data (eg. energy and environment data from objects) to the Web and to build their own applications based on that data.

PoKeys57CNC devices feature a direct support for the Xively web service. To configure PoKeys device for Xively, follow these steps:

1. Sign-up for a free account at <http://xively.com/>
2. Navigate to Develop and create a new private device
3. Under the created device information, you can find 'Feed ID' and 'API key' for your newly created device, as shown in the figure below.

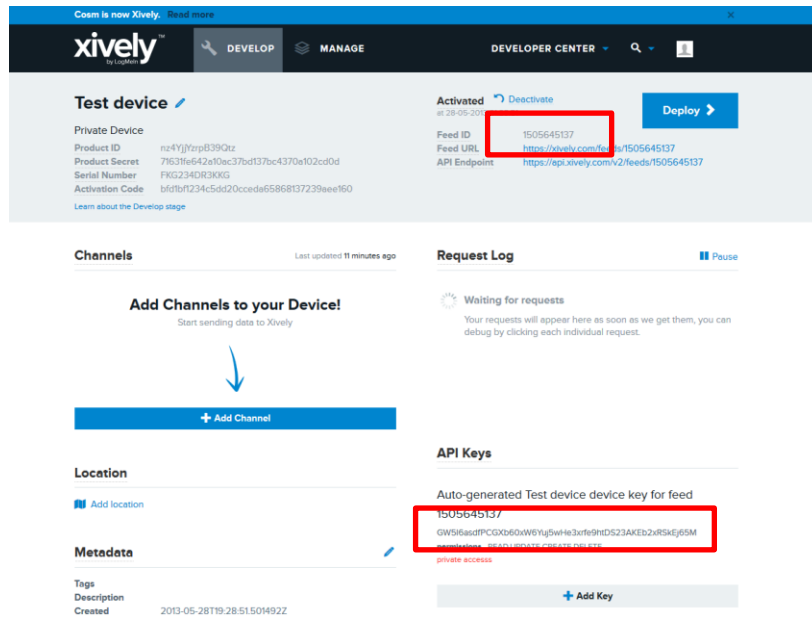

4. Open Device > Server reports configuration. Check 'Xively web service' option.
5. Enter your Xively API key and Feed ID, created in step 3, leave other fields with default values

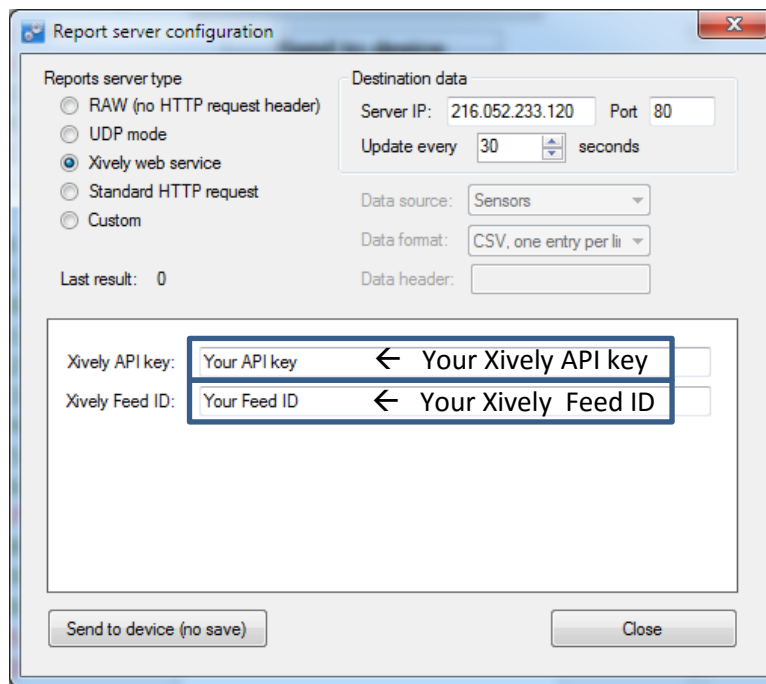

Figure 47: Reports server settings for Xively service

6. Select the update rate on the right
7. Click Send to device button. If you wish to save the settings to non-volatile memory, click 'Send to device' on main PoKeys screen.
8. Go back to Device > Web interface settings to edit the dashboard items. Define entries as described in the 'Web interface' chapter of this manual. To enable uploading of the

dashboard item to the Xively service, select 'Server reports' as the user. The 'Item caption' field is used to identify the datastream in the selected Xively feed.

Make sure that item caption does not contain any invalid characters for Xively channel name (+, -, _, letters and numbers are allowed)

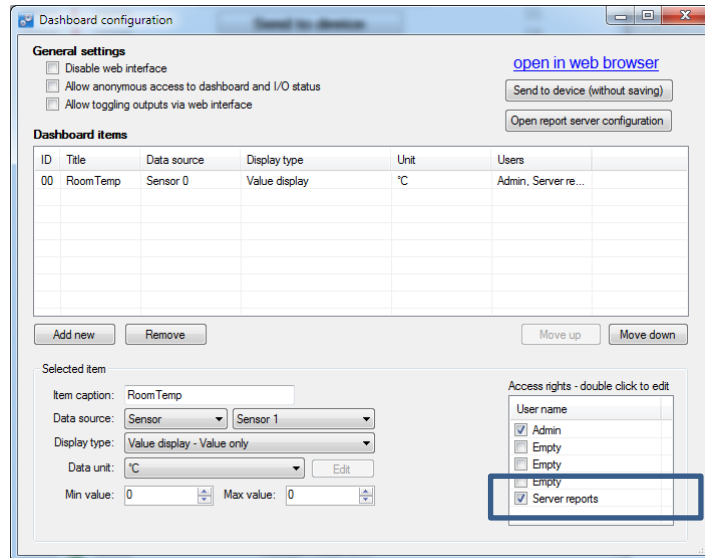
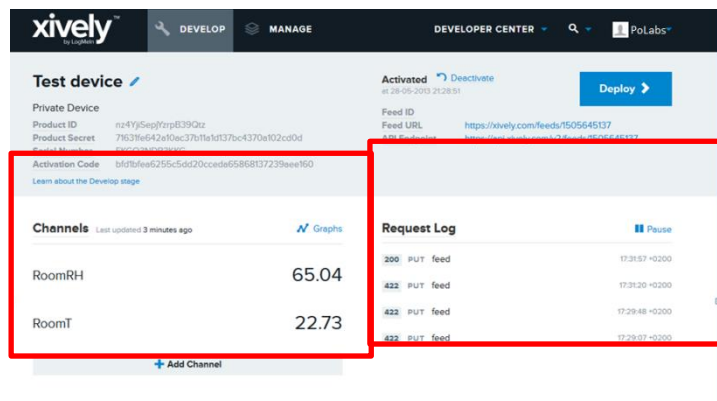

Figure 48: Item configuration for the Xively service

9. Save the settings again by clicking 'Send to device' button.
10. Make sure the PoKeys device has properly configured network settings and that it is connected to the internet
11. After a update interval, check the status of the Xively updates in the Xively 'Develop' page



12. Open your Xively feed by clicking the Feed URL – you should see the recorded data

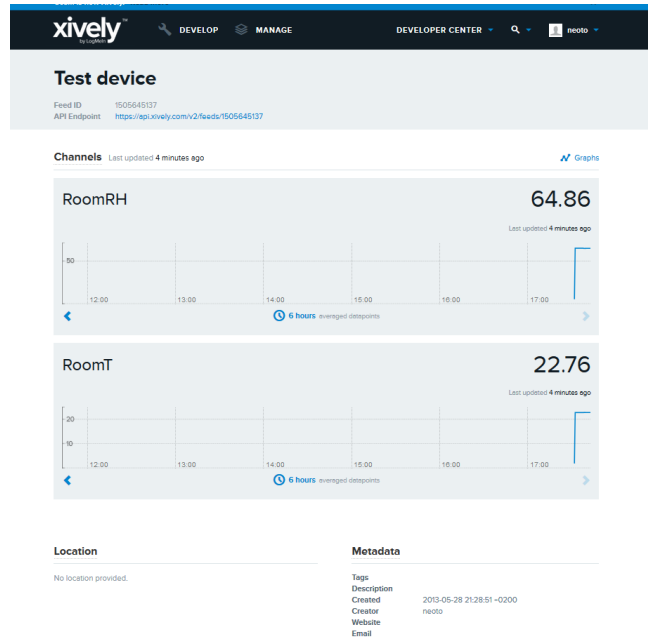

Figure 49: Xively feed overview page

Setup for standard HTTP POST or PUT data upload

Let's assume that the user wants to send sensor data to his server script that accepts POST method for data upload. The user's server script is available at the address `www.userdomain.com/PoKeysDataUpload.asp`. The user also wants that the data in the POST stream to have the HTTP type of 'text/plain' and preceded with the string 'MyData: '. The data should be transferred every 10 minutes. The settings are displayed in Figure 50.

To setup PoKeys to use these settings, the following steps must be taken (enter text without ' quotes):

1. Open Device > Server reports configuration.
2. Select 'Standard HTTP request' and check HTTP POST option
3. Enter 'www.userdomain.com/PoKeysDataUpload.asp' in the Destination field
4. Enter 'text/plain' in the 'Content-type' field.
5. Enter 'MyData: ' in the 'Data header' field
6. Enter the server's IP address and port number in the fields below.
7. Enter 600 in the update time field
8. Click Close and click Send to device button.
9. Go to Device > Web interface settings and define entries as described in the 'Web interface' chapter of this manual. To enable uploading of the dashboard item to the web server, select 'Server reports' as the user. The 'Item caption' field is used to identify the datastream.
10. Save the settings again by clicking 'Send to device' button.
11. Make sure the PoKeys device has properly configured network settings and that it is connected to the internet

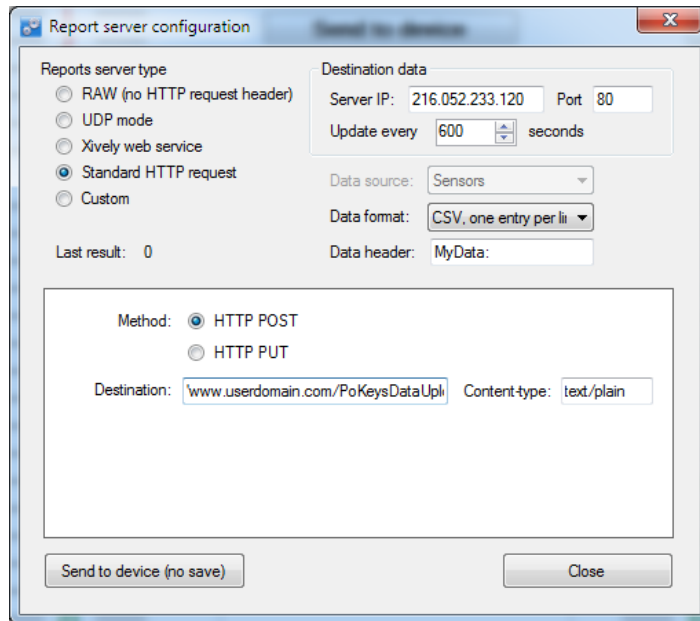

Figure 50: Example of HTTP POST service setup

7.17. Changing User ID number

Users can freely assign their own User ID number that represents a specific PoKeys device (enables distinguishing between different PoKeys devices in case there is more than one connected to a single host PC). To change the User ID number, go to 'Device' > 'Change user ID' menu. Simply enter any number between 0 and 255, and click the 'Change user ID' button.

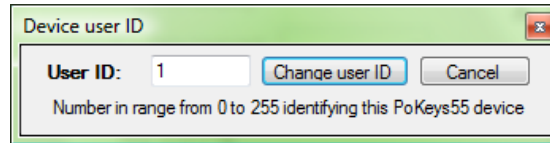

Figure 51: Device user ID dialog

7.18. Saving current configuration to file

To save the current configuration to a file, go to 'File' > 'Save' menu and select a new filename. To reload a saved configuration from a file, go to 'File' > 'Open' menu and select the appropriate file. To transfer new settings to the device, click on the 'Save to device' button.

7.19. PoIL core functionality

PoKeys57CNC contains PoIL core that is fully compatible with other PoKeys devices. Read the separate PoIL core documentation for more information.

Due to the omission of the 3V lithium backup battery, PoKeys57CNC does not support value retention in case of power failure.

8. Device recovery mode

If configuration editor cannot be used to reconfigure the device, use the following steps to start the device in the recovery mode. Recovery mode can be used to clear the configuration or update the firmware.

1. Disconnect PoKeys57CNC device from USB and remove power supply
2. Locate LCD connector on the PoKeys57CNC device and short the pins 1 and 3 as shown below

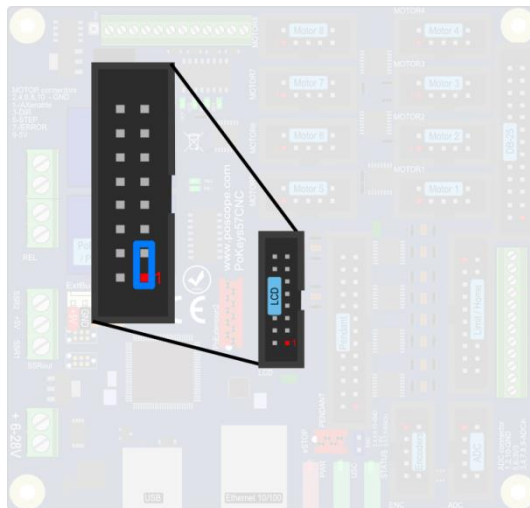

3. Reconnect the PoKeys device to USB (or reconnect power)
4. Green status light should start flashing rapidly and PoKeys device will connect in recovery mode
5. Open PoKeys configuration application
6. PoKeys configuration application should detect PoKeys57CNC device in recovery mode.
 - a. To reset the device configuration, use the option 'Clear settings'. By clicking this button and confirming your decision on the next dialog, settings will be erased.
 - b. To recover from bad firmware update, click 'Recover'.
7. After completing the operation, unplug PoKeys device and remove the short from the LCD connector
8. If resetting the configuration, ensure the device is properly cleared – replug PoKeys57CNC device, connect to it and execute Device > Clear settings in device.

9. Frequently asked questions

What software must be installed to operate the device?

On first use or when reconfiguring the device, the supplied software must be installed. If USB connection is to be used, device driver must be used that should be automatically installed by the setup package.

Can I use both USB and Ethernet connections?

Yes, both USB and Ethernet connections can be connected at the same time, but USB connection will have a priority over Ethernet.

Windows can not find drivers for PoKeys57CNC device

The drivers should automatically be installed by PoKeys setup package. If this is not the case and Windows reports unknown device, install the drivers manually by instructing the Windows device setup wizard to look for drivers in PoKeys installation folder (*C:\Program Files\PoLabs\PoKeys* by default).

I misconfigured the device and device no longer responds. What can I do?

If you misconfigured the device in such a way that configuration utility cannot be used to repair the configuration, see the section 'Quick resetting the device configuration' in this manual.

There is spontaneous triggering of some of the pins. What is wrong?

Although the device implements basic noise filtering on the digital inputs, long wires between PoKeys device and switches can cause spontaneous triggering if those wires are located near high-power electrical wiring. Use twisted pair wires, shielding and try to route the signal wires away from power supply wires.

The connection with the PoKeys device cannot be established with 10BASE-T router

Please check that you are using proper cable that is supported by 10BASE-T standard. The following diagram shows the correct wiring for different connection standards.

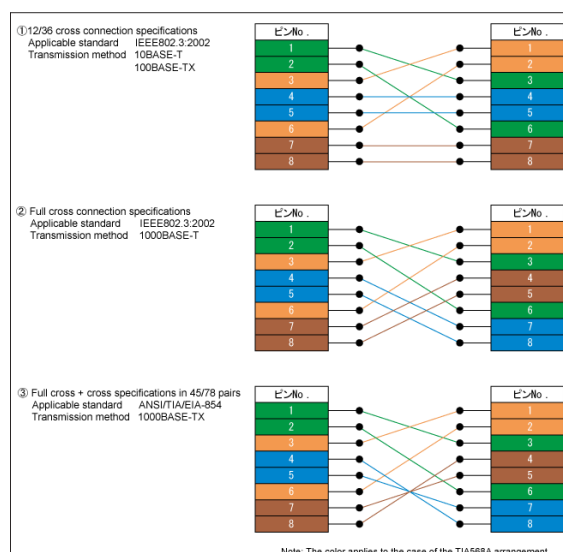

(source: http://www.okidensen.co.jp/en/prod/cable/lan/img/cate6_n_fig05.gif)

10. Errata information

This section describes special limitations of the device.

PoKeys device resets when external power supply is applied or removed

If PoKeys device is connected to USB, the device resets when external power supply is either applied or removed.

External pull-up resistor needed on the probing input

On PoKeys57CNC v1.0, v1.1 and v1.2 hardware, external pull-up resistor is required for correct operation of the probing input.

11. Grant of license

The material contained in this release is licensed, not sold. PoLabs grants a license to the person who installs this software, subject to the conditions listed below.

Access

The licensee agrees to allow access to this software only to persons who have been informed of and agree to abide by these conditions.

Usage

The software in this release is for use only with PoLabs products or with data collected using PoLabs products.

Copyright

PoLabs claims the copyright of, and retains the rights to, all material (software, documents etc) contained in this release. You may copy and distribute the entire release in its original state, but must not copy individual items within the release other than for backup purposes.

Liability

PoLabs and its agents shall not be liable for any loss or damage, howsoever caused, related to the use of PoLabs equipment or software, unless excluded by statute.

Fitness for purpose

No two applications are the same, so PoLabs cannot guarantee that its equipment or software is suitable for a given application. It is therefore the user's responsibility to ensure that the product is suitable for the user's application.

Mission Critical applications

Because the software runs on a computer that may be running other software products, and may be subject to interference from these other products, this license specifically excludes usage in 'mission critical' applications, for example life support systems.

Viruses

This software was continuously monitored for viruses during production, however the user is responsible for virus checking the software once it is installed.

Support

No software is ever error-free, but if you are unsatisfied with the performance of this software, please contact our technical support staff, who will try to fix the problem within a reasonable time.

Upgrades

We provide upgrades, free of charge, from our web site at www.poscope.com. We reserve the right to charge for updates or replacements sent out on physical media.

Trademarks

Windows is a registered trademark of Microsoft Corporation. PoKeys, PoKeys55, PoKeys56U, PoKeys56E, PoScope, PoLabs and others are internationally registered trademarks.

support: www.poscope.com