

# **KERN**<sup>®</sup>

**KERN & Sohn GmbH**

Ziegelei 1

D-72336 Balingen

E-Mail: [info@kern-sohn.com](mailto:info@kern-sohn.com)

Phone: +49-[0]7433-9933-0

Fax: +49-[0]7433-9933-149

Internet: [www.kern-sohn.com](http://www.kern-sohn.com)

## **Operating manual Universal density determination set for KERN Analytical balances**

### **KERN YDB-03**

Version 1.3  
2019-07  
GB



YDB-03-BA-e-1913



# KERN YDB-03

Version 1.3 2019-06

Operating manual

Universal density determination set for KERN Analytical  
balances

## Contents

<b>1</b>	<b>INTRODUCTION</b> .....	<b>5</b>
1.1	SCOPE OF DELIVERY .....	5
<b>2</b>	<b>DIMENSION [MM]</b> .....	<b>8</b>
<b>3</b>	<b>PRINCIPLE OF DENSITY DETERMINATION</b> .....	<b>11</b>
3.1	INFLUENCING MAGNITUDES AND ERROR SOURCES .....	12
<b>4</b>	<b>COMMISSIONING</b> .....	<b>13</b>
4.1	ALLOCATION LIST FOR ADAPTER AND COMPENSATION WEIGHTS.....	13
4.2	PREPARING THE FRAME .....	14
4.3	INSTALLATION.....	15
4.3.1	How to prepare the weighing balance .....	15
4.3.2	Installing the density determination set .....	16
<b>5</b>	<b>DENSITY DETERMINATION OF SOLIDS</b> .....	<b>18</b>
<b>5.1</b>	<b>SERIES KERN ABS-N, ACS</b> .....	<b>18</b>
5.1.1	Invoke mode for density determination of solid material .....	18
5.1.2	Determine density of sinking solid bodies ( $d > 1 \text{ g/cm}^3$ ).....	21
5.1.3	Determine density of floating solid bodies ( $d < 1 \text{ g/cm}^3$ ) .....	23
<b>5.2</b>	<b>SERIES KERN TABS, TABJ</b> .....	<b>26</b>
5.2.1	Parameter setting .....	26
5.2.2	Determine density of sinking solid bodies ( $d > 1 \text{ g/cm}^3$ ).....	32
5.2.3	Determine density of floating solid bodies ( $d < 1 \text{ g/cm}^3$ ) .....	34
<b>5.3</b>	<b>SERIES KERN ABT</b> .....	<b>37</b>
5.3.1	Invoke mode for density determination of solid material .....	37
5.3.2	Enter density of the auxiliary liquid .....	38
5.3.3	Determine density of sinking solid bodies ( $d > 1 \text{ g/cm}^3$ ).....	39
5.3.4	Determine density of floating solid bodies ( $d < 1 \text{ g/cm}^3$ ) .....	40
<b>5.4</b>	<b>SERIES KERN AES-C</b> .....	<b>42</b>
5.4.1	Invoke mode for density determination of solid material .....	42
5.4.2	Determine density of sinking solid bodies ( $d > 1 \text{ g/cm}^3$ ).....	45
5.4.3	Determine density of floating solid bodies ( $d < 1 \text{ g/cm}^3$ ): .....	46
<b>5.5</b>	<b>SERIES KERN ALS-A</b> .....	<b>47</b>
5.5.1	Determine density of sinking solid bodies ( $d > 1 \text{ g/cm}^3$ ).....	47
5.5.2	Determine density of floating solid bodies ( $d > 1 \text{ g/cm}^3$ ): .....	49

<b>5.6</b>	<b>SERIES KERN ALT-B</b> .....	50
5.6.1	Determine density of sinking solid bodies ( $d > 1 \text{ g/cm}^3$ ).....	50
5.6.2	Determine density of floating solid bodies ( $d < 1 \text{ g/cm}^3$ ):.....	52
<b>5.7</b>	<b>SERIES KERN AET</b> .....	53
5.7.1	Invoke mode for density determination of solid material and enter parameters of the auxiliary liquid .....	54
5.7.2	Determine density of sinking solid bodies ( $d > 1 \text{ g/cm}^3$ ).....	57
5.7.3	Determine density of floating solid bodies ( $d < 1 \text{ g/cm}^3$ ) .....	59
5.7.4	Log density determination.....	60
<b>5.8</b>	<b>KERN ABP SERIES</b> .....	62
5.8.1	Installing the density determination set .....	62
5.8.2	Parameter setting .....	63
5.8.3	Determining density of sinking solid bodies ( $d > 1 \text{ g/cm}^3$ ).....	68
5.8.4	Determining density of floating solid bodies ( $d < 1 \text{ g/cm}^3$ ) .....	70
<b>6</b>	<b>DETERMINING DENSITY OF LIQUIDS</b> .....	<b>73</b>
6.1	DETERMINATION OF THE SINKER VOLUME.....	73
6.2	SERIES KERN ABS-N, ABJ-NM, ACS, ACJ .....	74
6.2.2	Determining density of the test liquid.....	76
6.3	SERIES KERN TACS / TABJ.....	79
6.3.1	Parameter setting .....	79
6.3.2	Determining density of the test liquid.....	84
6.4	SERIES KERN ABT.....	87
6.4.2	Enter density of the sinker .....	89
6.4.3	Determining density of the test liquid.....	90
6.5	SERIES KERN AES-C.....	91
6.5.2	Determining density of the test liquid.....	93
6.6	SERIES KERN ALS-A .....	94
6.7	SERIES KERN ALT_B.....	96
<b>6.8</b>	<b>SERIES KERN AET</b> .....	<b>98</b>
<b>6.8.1</b>	<b>Call up density determination mode of liquids and enter sinker volume</b> .....	<b>98</b>
<b>6.8.2</b>	<b>Determining density of the test liquid</b> .....	<b>99</b>
<b>6.8.3</b>	<b>Log density determination</b> .....	<b>101</b>
6.9	KERN ABP SERIES .....	103
6.9.1	Installing the density determination set .....	103
6.9.2	Parameter setting .....	104
6.9.3	Determination of the examined liquid density.....	107

<b>7</b>	<b>PRECONDITIONS FOR PRECISE MEASUREMENTS.....</b>	<b>109</b>
7.1	CALCULATION OF RESULTS .....	109
7.2	INFLUENCE FACTORS FOR MEASUREMENT ERRORS .....	109
7.2.1	Air bubbles .....	109
7.2.2	Solid body sample .....	109
7.2.3	Liquids.....	110
7.2.4	Surface.....	110
7.2.5	Sinker for density determination of liquids .....	110
7.3	GENERAL INFORMATION.....	110
7.3.1	Density / Relative Density.....	110
7.3.2	Drift of Balance Display .....	110
<b>8</b>	<b>DENSITY TABLE FOR LIQUIDS.....</b>	<b>111</b>
<b>9</b>	<b>USER INSTRUCTIONS.....</b>	<b>112</b>

# 1 Introduction



- In order to guarantee a safe and trouble-free operation, please read carefully the operating instructions.
- These operating instructions only describe the operation of the density determination set. For further information on how to operate your balance please refer to the operating instructions supplied with each balance.

## 1.1 Scope of delivery

- ⇒ Check packaging and density determination set immediately when unpacking for possible visible damage.
- ⇒ Make sure that all parts are completely present.

### ① Frame



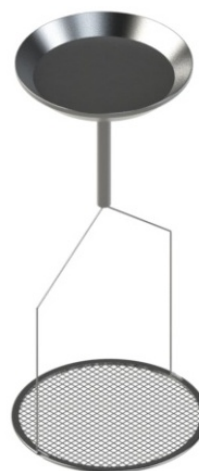
### ② Platform



- 3 Beaker



- 4 Universal immersion basket for sinking and floating solid matter



- 5 Sinker  
20 g stainless steel weight



- 6 Thermometer



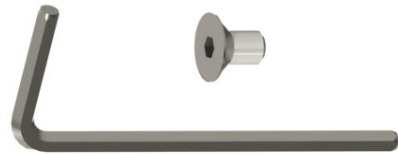
- 7 Compensation weights  
(3 pairs)



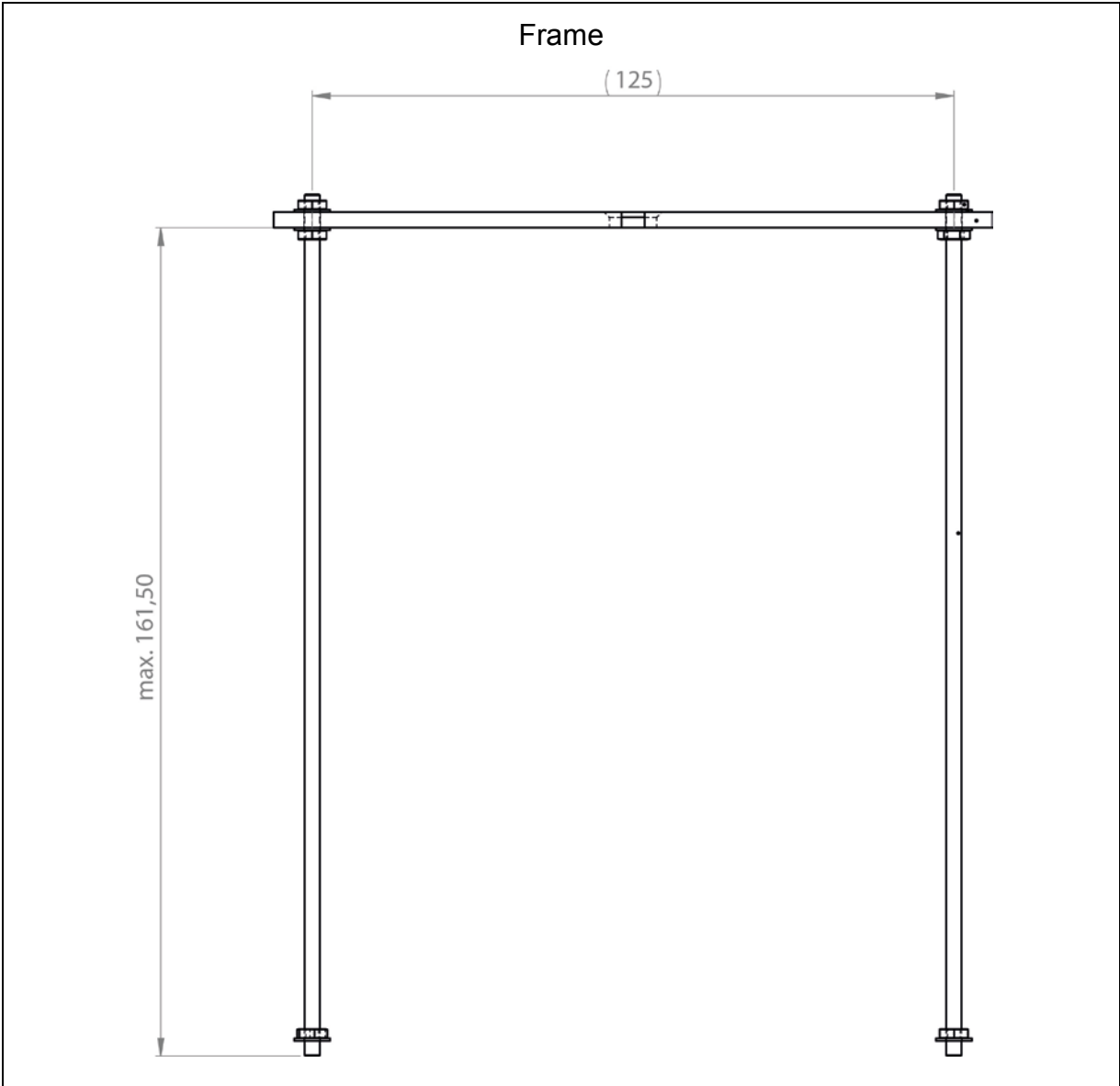
- ③ Adapter  
(4 items)



- ⑨ Allen wrench + screw



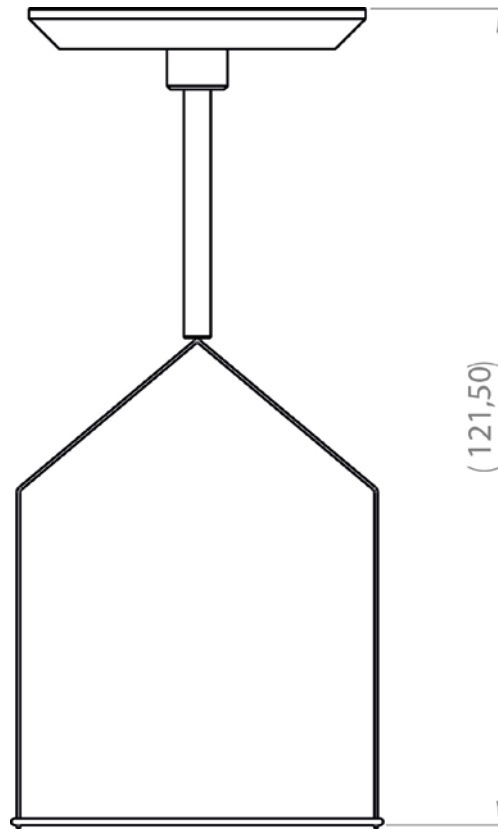
## 2 Dimension [mm]



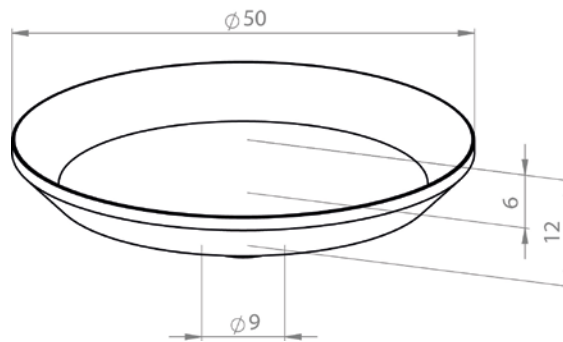
English



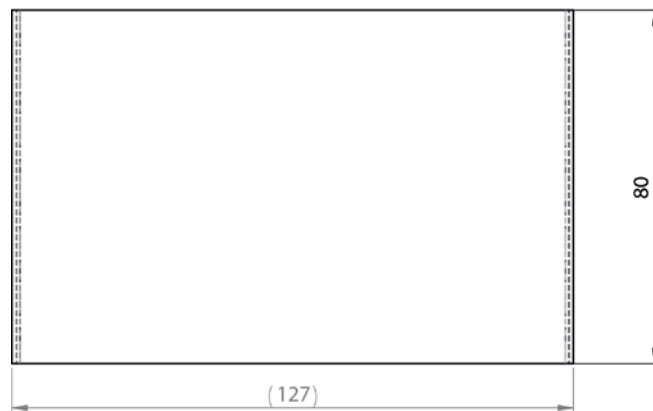
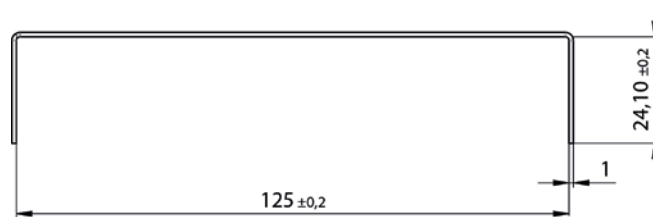
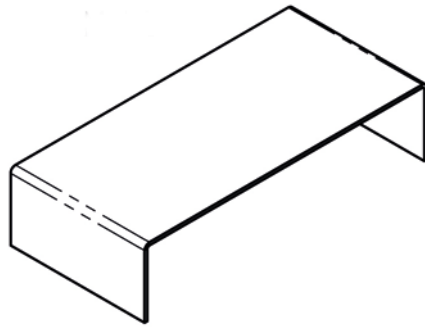
Universal immersion basket for floating and descending solid matter



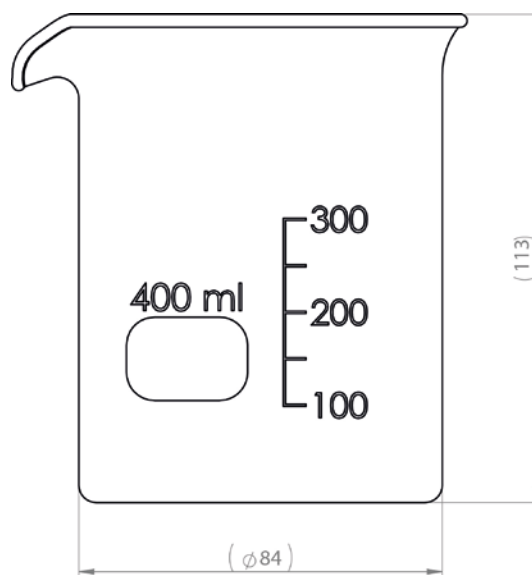
Sample dish



### Platform



### Beaker



### 3 Principle of Density Determination

Three physical magnitudes are the **volume** and the **mass** of bodies as well as the **density** of matter. In density mass and volume are related.

**Density [  $\rho$  ] is the relation of mass [ m ] to volume [ V ].**

$$\rho = \frac{m}{V}$$

SI-unit of density is kilogram divided by cubic meter (kg/m<sup>3</sup>). 1 kg/m<sup>3</sup> equals the density of a homogenous body that, for a mass of 1 kg, has the volume of 1 m<sup>3</sup>.

Additional frequently applied units include:

$$1 \frac{\text{g}}{\text{cm}^3}, \quad 1 \frac{\text{kg}}{\text{m}^3}, \quad 1 \frac{\text{g}}{\text{l}}$$

The application of this density determination set in combination with the KERN analytical balances provides fast and safe density determination of solids and fluids. Our set uses the "**Principle of Archimedes**" to determine density:

BUOYANCY IS A FORCE. IT AFFECTS A BODY THAT IS IMMERSSED INTO A LIQUID. THE BUOYANCY OF THE BODY EQUALS THE WEIGHT FORCE OF THE DISPLACED LIQUID. THE FORCE OF BUOYANCY ACTS VERTICALLY UPWARDS.

Thus, density is calculated according to the formulae below:

#### To determine the density of solid matter

Our balances enable weighing of solids in air [ A ] as well as water [ B ]. If the density of the buoyancy medium is known [  $\rho_o$  ] the density of the solid [  $\rho$  ] is calculated as follows:

$$\rho = \frac{A}{A-B} \rho_o$$

$\rho$  = Density of sample

A = Weight of the sample in air

B = Weight of the sample in the aid liquid

$\rho_o$  = Density of the aid liquid



The air buoyancy is not considered in the formula.

## Determining density of liquids

The density of a liquid is determined with the help of a sinker providing a known volume [ V ]. The sinker is weighed in air [ A ] as well as in the test liquid [ B ].

According to the Archimedes' Principle a body immersed in a liquid experiences a force of buoyancy [ G ]. This force equals the weight force of the liquid displaced by the volume of the body.

The volume [ V ] of the immersed body equals the volume of the displaced liquid.

$$\rho = \frac{G}{V}$$

G = buoyancy of sinker

Buoyancy of sinker =

Weight of the sinker in air [ A ] - weight of sinker in test liquid [ B ]

From this follows:

$$\rho = \frac{A-B}{V} + \rho_L$$

$\rho$  = Density of test liquid

A = weight of sinker in air

B = weight of the sinkers in test liquid

V = volume of sinker

### 3.1 Influencing magnitudes and error sources









- ⇒ Air buoyancy
- ⇒ Temperature
- ⇒ Surface tension of the liquid
- ⇒ Adhesion of liquid on the wire
- ⇒ Air bubbles
- ⇒ Immersion depth of the sample dish or of the sinker
- ⇒ Porosity of the solid

## 4 Commissioning

The density determination set KERN YDB-03 can be used with the following series of the KERN analytical balance:

- KERN ABJ-N, ABS-NM
- KERN AES-C, AEJ-NM
- KERN ABP
- KERN AET
- KERN ABT
- KERN ALS-A, ALJ-A
- KERN ACS, ACJ
- KERN ALT-B
- KERN TACS, ACJ

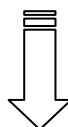
### 4.1 Allocation list for adapter and compensation weights

	ABT	ABS-N ABJ-NM	ACS/ACJ TACS/TACJ	ALS-A ALJ-A	ALT-B	ABP
Adapter	 1			 3		 4
Compensation weights	 1	 2		Not required		 1
	AES-C, AEJ-CM		AET			
Adapter	 2					
Compensation weights	AES-C, AEJ-CM		AET 200-4NM AET 500-4		AET 100-5M AET 200-5DM	
	 3				Not required	

## 4.2 Preparing the frame

Before the frame is placed on the balance, assemble the adapter belonging to the scale, see allocation list chap. 4.1.

Use the Allen wrench and the screw included in the scope of delivery.



## 4.3 Installation

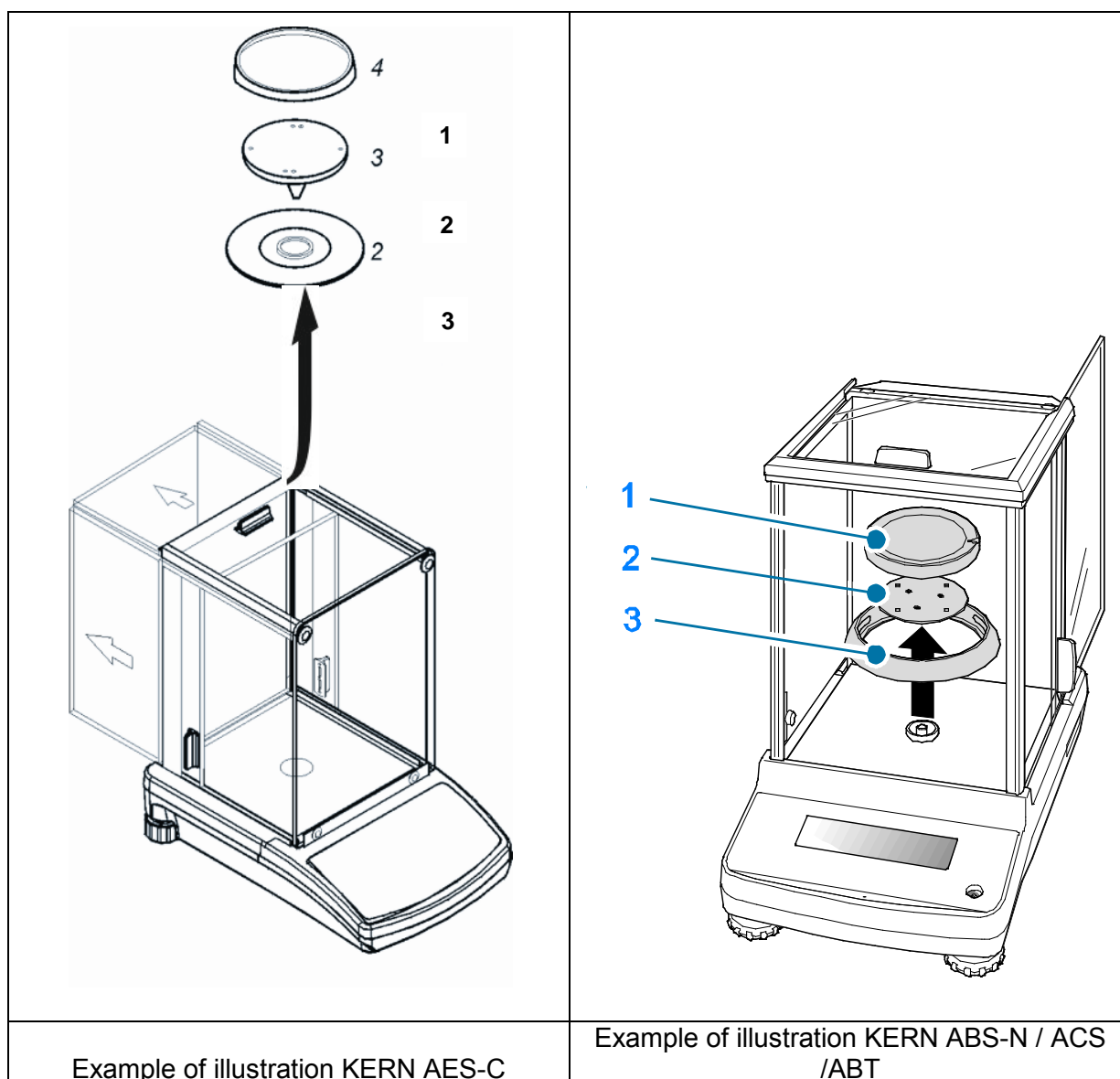
### 4.3.1 How to prepare the weighing balance



- If necessary, carry out necessary adjustment before installation of the density set.
- Correct adjustment is no longer possible after the density kit has been installed.
- For reasons of adjustment, take away the density set and place the standard weighing plate.

⇒ Disconnect scale from power supply.

⇒ Remove standard weighing plate and accessories such as screening ring and weighing plate carrier.



### 4.3.2 Installing the density determination set

- ⇒ Insert frame in the weighing compartment. The round opening above at the frame has to point into the direction where the immersion basket is inserted from.
- ⇒ Put the supporting platform of the glass beaker through the frame on the weighing compartment floor. Place it in a way that it does not touch the frame.
- ⇒ If necessary place compensation weights on the frame, see allocation list chap. 4.1. If when the balance is switched on, the error message „underload“ appears, use only the compensation weights suitable for the respective balances.
- ⇒ Hang the immersion basket on the rack. Make sure that it is centred in the recess.



- ⇒ Close the glass doors. Connect the balance to the power supply and switch on.
- ⇒ Bring liquid and instruments to the right temperature until you achieve a constant temperature. Observe the warm-up time of the balance.



To avoid corrosion, don't leave the density set immersed in liquid for a long time.





Example of illustration with installed density sets KERN YDB-03

- ① Upper sample dish of the immersion basket
- ② Frame
- ③ Beaker
- ④ Lower sifting bowl of immersion basket
- ⑤ Compensation weights
- ⑥ Platform

## 5 Density determination of solids

For the determination of the density of solids, the solid is first weighed in air and then in the aid liquid, whose density is known. From the weight difference results the buoyancy from where the software calculates the density.

As aid liquid, usually distilled water or ethanol is used, see density table chapter 8.

### Preparation:

⇒ Install density determination set, see chap. 4.3.2

### 5.1 Series KERN ABS-N, ACS

#### 5.1.1 Invoke mode for density determination of solid material

⇒ Turn on balance by pressing the **ON/OFF** key.



⇒ Call up menu:  
In weighing mode press the **MENU** button twice.

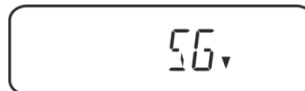


⇒ Press the navigation buttons (↓ ↑) repeatedly until „**APL.FUNC**“ is displayed.



⇒ Press the **PRINT** key.

⇒ Press the navigation buttons (↓ ↑) repeatedly until „**SG**“ is displayed. To confirm, press **TARE**, "SET" followed by your current setting will be displayed.



- ⇒ Press the cursor keys (↓ ↑) repeatedly until "S.SG" ("density determination solid matter") is displayed.

· S.SG, ↓

- ⇒ Confirm with **TARE**. "SET" followed by the currently set auxiliary liquid (e.g. water) is displayed.

· SET, ↓

· WATER, ↓

Distilled water

- ⇒ Press the cursor keys (↓ ↑) repeatedly until the desired auxiliary fluid is displayed.

· OTHER, ↓

Select auxiliary fluid of your choice of known density

· ETHL, ↓

Ethanol

· METHL, ↓

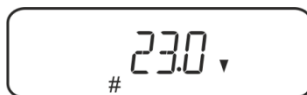
Methanol

- ⇒ To confirm, press **TARE**, "SET" followed by the display used to enter "temperature auxiliary fluid" will appear.

· SET, ↓

· LTEMP, ↓

- ⇒ Press **TARE** and the display will change to numeric data input.  
The temperature currently set will be displayed if water, ethanol or methanol is selected.



On selecting "OTHER" the currently set density of the fluid is displayed.

**either**

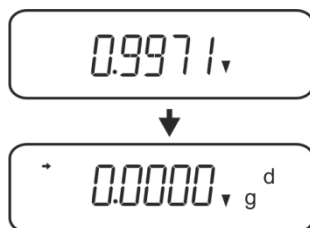
during selection of water, ethylic or methyl alcohol read temperature at the thermometer and enter with the help of the navigation keys.

**or**

if selecting "OTHER" enter density of the auxiliary liquid of your choice.

<b>Numeric input</b>	
# indicates that the weighing balance is in numeric input mode. The first digit is flashing and can be changed.	
↑	Increase flashing digit
↓	Decrease flashing digit
→	Digit selection to the right
←	Confirm entry

- ⇒ The weighing balance will display the auxiliary fluid's density at the entered temperature for about 3 sec and will then change to "density determination solid matter" mode.



To change from density mode ⇔ to weighing mode press **MENU** for 3 s.

### 5.1.2 Determine density of sinking solid bodies ( $d > 1 \text{ g/cm}^3$ )

1. Remove the immersion basket and place the glass beaker filled with the auxiliary liquid in the centre of the platform. Filling height should be approx.  $\frac{3}{4}$  of the capacity. Make sure that it has no contact with the frame. Remount the immersion basket. Make sure that it does not touch the glass beaker. Set balance to zero.
2. Make sure that the balance is in the mode "density determination solid material" (see chap. 5.1.1).

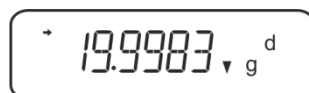


3. Put the solid material into the upper sample dish.



Fig.1: Weighing in air

The weight of the „sample in air“ is displayed.



4. Wait until stability display (→) appears, then press **UNIT**. "SINK" will be shown.



5. Put solid material into the lower sifting bowl.  
For this remove the immersion basket out from the frame. Always ensure that, when re-immersing into the liquid, no additional bubbles adhere; it is better to use pincers or alike to place the sample directly on the sifting bowl. Make sure that the sample is at least 1 cm immersed.



Figure 2: Weighing in auxiliary liquid

6. Press the **UNIT** button. "WAIT" is displayed. The weighing scale first determines, then displays the solid matter's density.



7. If you connect an optional printer you can print the result.  
8. Remove the sample. To carry out further measuring, press **UNIT**, and then start with step 2.



To avoid corrosion, don't leave the density set immersed in liquid for a long time.

### Printout example KERN YKB-01N:

KERN & Sohn GmbH	Company
TYPE ACS 320-4	Model
SN WB11AG0002	Serial no.
ID 1234	Balance identification no.
1.2188DS	Result
-SIGNATURE-	prepared by
-----	

#### 5.1.3 Determine density of floating solid bodies ( $d < 1 \text{ g/cm}^3$ )

At solid material with density less than  $1 \text{ g/cm}^3$ , a density determination with two different methods is possible.

##### Method 1:

How to carry out see chap. 5.1.2.

As aid liquid is used a liquid with less density than that of the solid material, e.g. ethanol approx.  $0.8 \text{ g/cm}^3$ .

This method should be applied when the density of the solid is just slightly different from that of the distilled water.

Using ethanol is not recommended, when the solid material is being attacked.



When working with ethanol, you must observe the applicable safety regulations.

## Method 2:

- ⇒ Remove the immersion basket and place the glass beaker filled with the auxiliary liquid in the centre of the platform. Filling height should be approx.  $\frac{3}{4}$  of the capacity. Make sure that it has no contact with the frame. Remount the immersion basket. Make sure that it does not touch the glass beaker. Set balance to zero.
- ⇒ Make sure that the balance is in the mode "density determination solid material" (see chap. 5.1.1).

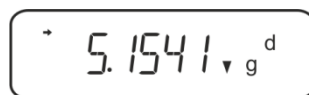


- ⇒ Put the solid material into the upper sample dish.



Fig. 3: Weighing in air

The weight of the „sample in air“ is displayed.



- ⇒ Wait until stability display (→) appears, then press **UNIT**. "SINK" will be shown.





- ⇒ Place the solid material entirely **under** the lower sifting bowl.  
For this purpose remove the immersion basket and when re-immersing place the sample possibly free of bubbles under the sifting bowl.  
Or if possible place the sample using pincers or alike directly under the sifting bowl.



Fig. 4: Weighing in auxiliary liquid

The weighing scale first determines, then displays the solid matter's density.



- ⇒ If you connect an optional printer you can print the result.
- ⇒ Remove the sample. To carry out further measuring, press **UNIT**, and then start with step 2.



To avoid corrosion, don't leave the density set immersed in liquid for a long time.

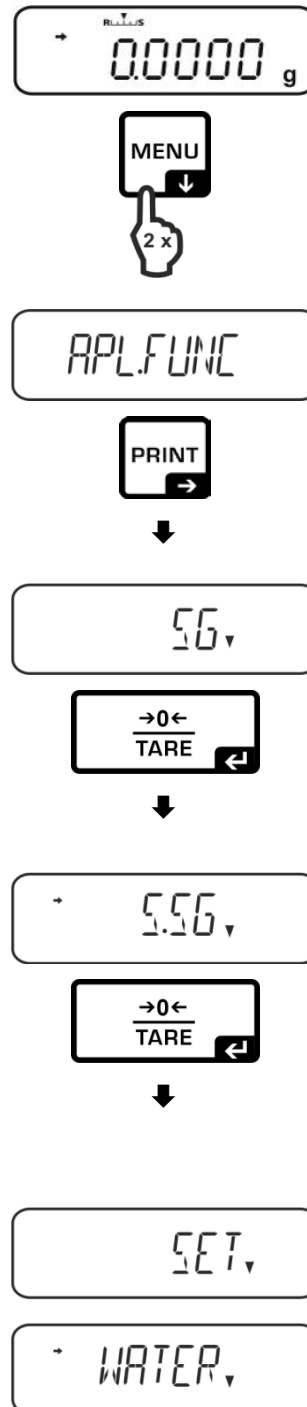
## 5.2 Series KERN TABS, TABJ

- Install the density determination module – see ch. 4.3.2

### 5.2.1 Parameter setting

#### 1. Selection of application

- ⇒ Go to the menu:  
In the weighing mode, press the **MENU** button twice.
- ⇒ Press the navigation buttons (↓ ↑) until “APL.FUNC” appears.
- ⇒ Confirm by pressing **PRINT**.
- ⇒ Press the navigation buttons (↓ ↑) until “SG” appears.
- ⇒ Confirm by pressing **TARE**. The display shows “SET” and the current setting.
- ⇒ By pressing **TARE**, select between the settings “SG” and “S.SG” (mode: “Determination of density of solids”). The current setting is marked by the stabilization indicator.



#### 2. Entry of reference liquid parameters

- ⇒ Confirm by pressing **TARE**. The display shows “SET” and the currently set reference liquid (e.g. water).
- ⇒ Press the navigation buttons (↓ ↑) until the required reference liquid appears.

⇒ Using navigation buttons  $\uparrow$   $\downarrow$ , select the reference liquid.

1. After selecting **<WATER>**, **<ETHL>** or **<METHL>**, enter the temperature of the reference liquid.

# WATER

Distilled water



# ETHL

Ethanol



# METHL

Methanol



# OTHER

Other reference liquid

or

2. After selecting **<OTHER>**, enter the known density of the reference liquid.

Selection between **<WATER>**, **<ETHL>** or **<METHL>** options

- ⇒ Confirm the selection by pressing TARE. The display shows "SET" and an indication to enter the parameter "Temperature of reference liquid".

# →0←  
TARE



SET

LTEMP

# →0←  
TARE



- ⇒ Press **TARE**. The display changes, so that you can enter a numerical value.

### Entry of numerical value

The # symbol shows that the balance is in the mode for entering a numerical value. The first item flashes, and you can change its value.

- $\uparrow$  Increase the value of the flashing digit
- $\downarrow$  Decrease the value of the flashing digit
- $\rightarrow$  Select the digit on the right
- $\leftarrow$  Confirm entered data

- ⇒ Read the temperature in the thermometer and enter its value by using navigation buttons.

Confirm by pressing **TARE**.

The balance will determine appropriate density from the integrated table of densities, and display it for approx. 3 s.

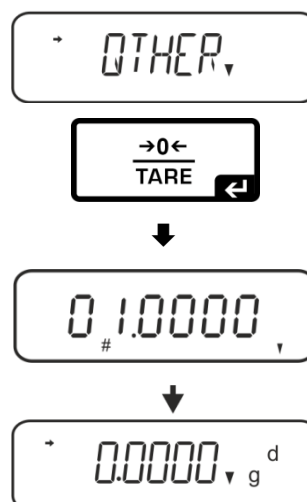
- ⇒ The balance switches to the mode “Determination of density of solids”.



- i** To switch between the modes “Density determination mode” ↔ “Weighing mode”, press the **MENU** button and hold it down for 3 s.

### Selection of <OTHER>

- ⇒ Press **TARE**. The display changes and you can enter a numerical value.
- ⇒ Using navigation buttons, enter the known density of the selected reference liquid. Confirm by pressing **TARE**.

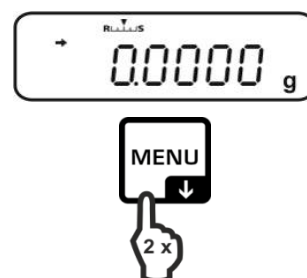


### 3. HOLD function <SG.HOLD>

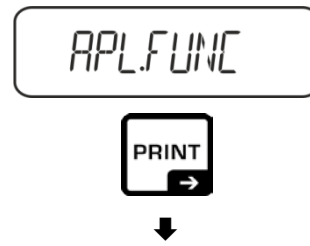
Data-HOLD function can be activated both for the determination of density of solids and liquids.

The displayed density value often fluctuates, and its reading may be difficult. When the function is active, the first result value is shown in the display until it is cancelled with the **UNIT** button.

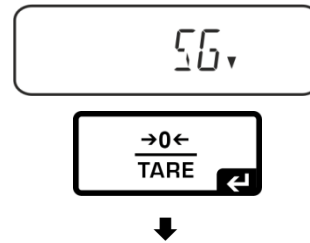
- ⇒ Go to the menu:  
In the weighing mode, press the **MENU** button twice.



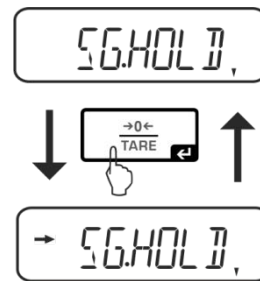
- ⇒ Press the navigation buttons (↓ ↑) until “APL.FUNC” appears.
- ⇒ Confirm by pressing PRINT.




- ⇒ Press the navigation buttons (↓ ↑) until “SG” appears.
- ⇒ Confirm by pressing TARE. The display shows “SET” and the current setting.

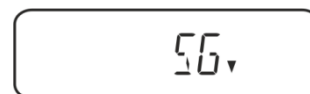
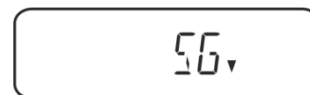


- ⇒ Press the navigation buttons (↓ ↑) until “SG.HOLD” appears.
- ⇒ Confirm by pressing TARE.
- ⇒ By pressing TARE, select between the settings “OFF” and “ON”. The current setting is marked by the stabilization indicator.



Stabilization indicator 	“SG.HOLD” setting
OFF	OFF
ON	ON

- ⇒ Go back to the menu by pressing **ON/OFF** and enter other settings.
- ⇒ Go back to the menu by pressing **ON/OFF** and enter other settings.



or

- ⇒ Go back to the density determination mode by repeatedly pressing the **ON/OFF** button.



#### 4. Air resistance correction <AIR.COR>

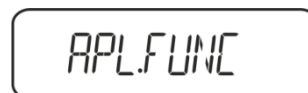
The balance offers a possibility to perform density calculations with and without correction for air resistance.

	"AIR.COR" setting	
	OFF	ON
	Calculation without air resistance correction *Factory setting	Calculation with air resistance correction
Determination of density of solids	$\rho = \frac{A}{A-B} \rho_o$ <p> <math>\rho</math> Density of sample            A Mass of sample in air            B Mass of sample in reference liquid  <math>\rho_o</math> Density of reference liquid         </p>	$\rho = \frac{A}{A-B} (\rho_o - \rho_\alpha) + \rho_\alpha$ <p> <math>\rho</math> Density of sample            A Mass of sample in air            B Mass of sample in reference liquid  <math>\rho_o</math> Density of reference liquid  <math>\rho_\alpha</math> Density of air (0.0012 g/cm<sup>3</sup>)         </p>

⇒ Go to the menu:  
In the weighing mode, press the **MENU** button twice.



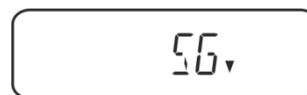
⇒ Press the navigation buttons (↓ ↑) until "APL.FUNC" appears.




⇒ Confirm by pressing **PRINT**.



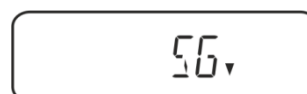
- ⇒ Press the navigation buttons (↓ ↑) until “SG” appears.
- ⇒ Confirm by pressing **TARE**. The display shows “SET” and the current setting.



- ⇒ Press the navigation buttons (↓ ↑) until “AIR.COR” appears.
- ⇒ Confirm by pressing **TARE**.
- ⇒ By pressing **TARE**, select between the settings “OFF” and “ON”. The current setting is marked by the stabilization indicator.

Stabilization indicator 	“AIR.COR” setting
OFF	OFF
ON	ON

- ⇒ Go back to the menu by pressing **ON/OFF** and enter other settings.



or

- ⇒ Go back to the density determination mode by repeatedly pressing the **ON/OFF** button.



### 5.2.2 Determine density of sinking solid bodies ( $d > 1 \text{ g/cm}^3$ )

1. Remove the immersion basket and place the glass beaker filled with the auxiliary liquid in the centre of the platform. Filling height should be approx.  $\frac{3}{4}$  of the capacity. Make sure that it has no contact with the frame. Remount the immersion basket. Make sure that it does not touch the glass beaker. Set balance to zero.
2. Make sure that the balance is in the mode "density determination solid material".



3. Put the solid material into the upper sample dish.



Fig.1: Weighing in air

The weight of the „sample in air“ is displayed.



4. Wait until stability display (→) appears, then press **UNIT**. "SINK" will be shown.



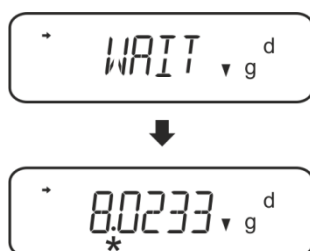


- Put solid material into the lower sifting bowl.  
For this remove the immersion basket out from the frame. Always ensure that, when re-immersing into the liquid, no additional bubbles adhere; it is better to use pincers or alike to place the sample directly on the sifting bowl. Make sure that the sample is at least 1 cm immersed.



Figure 2: Weighing in auxiliary liquid

- Press the **UNIT** button. "WAIT" is displayed. The weighing scale first determines, then displays the solid matter's density.



- If you connect an optional printer you can print the result.
- Remove the sample. To carry out further measuring, press **UNIT**, and then start with step 2.



To avoid corrosion, don't leave the density set immersed in liquid for a long time.

### Printout example KERN YKB-01N:

KERN & Sohn GmbH	Company
TYPE ACS 2 0-4	Model
SN WB19AG0002	Serial no.
ID 1234	Balance identification no.
1.2188DS	Result
-SIGNATURE-	prepared by
-----	

#### 5.2.3 Determine density of floating solid bodies ( $d < 1 \text{ g/cm}^3$ )

At solid material with density less than  $1 \text{ g/cm}^3$ , a density determination with two different methods is possible.

##### Method 1:

How to carry out see chap.5.2.2.

As aid liquid is used a liquid with less density than that of the solid material, e.g. ethanol approx.  $0.8 \text{ g/cm}^3$ .

This method should be applied when the density of the solid is just slightly different from that of the distilled water.

Using ethanol is not recommended, when the solid material is being attacked.



When working with ethanol, you must observe the applicable safety regulations.

## Method 2:

- ⇒ Remove the immersion basket and place the glass beaker filled with the auxiliary liquid in the centre of the platform. Filling height should be approx.  $\frac{3}{4}$  of the capacity. Make sure that it has no contact with the frame. Remount the immersion basket. Make sure that it does not touch the glass beaker. Set balance to zero.
- ⇒ Make sure that the balance is in the mode "density determination solid material".

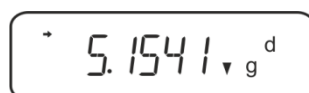


- ⇒ Put the solid material into the upper sample dish.



Fig. 3: Weighing in air

The weight of the „sample in air“ is displayed.



- ⇒ Wait until stability display (→) appears, then press **UNIT**. "SINK" will be shown.

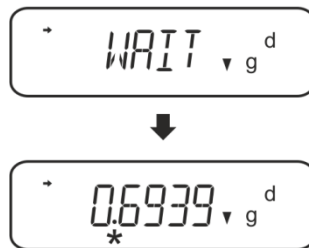


- ⇒ Place the solid material entirely **under** the lower sifting bowl.  
For this purpose remove the immersion basket and when re-immersing place the sample possibly free of bubbles under the sifting bowl.  
Or if possible place the sample using pincers or alike directly under the sifting bowl.



Fig. 4: Weighing in auxiliary liquid

The weighing scale first determines, then displays the solid matter's density.



- ⇒ If you connect an optional printer you can print the result.  
⇒ Remove the sample. To carry out further measuring, press **UNIT**, and then start with step 2.



To avoid corrosion, don't leave the density set immersed in liquid for a long time.

## 5.3 Series KERN ABT

### 5.3.1 Invoke mode for density determination of solid material

⇒ Turn on balance by pressing the **ON/OFF** key.



⇒ Call up menu:

In weighing mode press the **CAL** key repeatedly until „FUNC.SEL“ is displayed.



⇒ Press the **TARE** key.



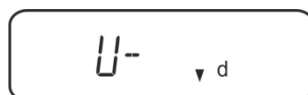
⇒ Press the **CAL** button repeatedly until „Unit.SEL“ will be displayed.



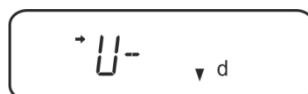
⇒ Press the **TARE** key.



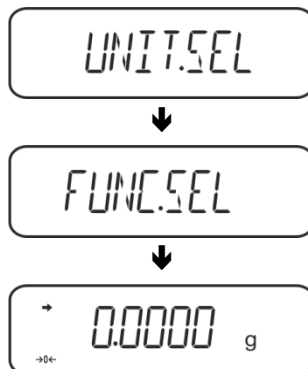
⇒ Press **CAL** key repeatedly until „U- ▾ d“ (mode "density determination solid material") is displayed.



⇒ Make sure that the stability display (→) appears, if not, confirm with the **TARE** key.



⇒ Back to menu / weighing mode, press **ON/OFF** key repeatedly



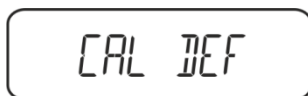
### 5.3.2 Enter density of the auxiliary liquid



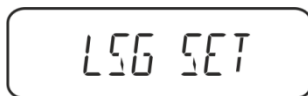
⇒ In weighing mode press the **CAL** key repeatedly until „SettinG“ is displayed.




⇒ Press the **TARE** key.



⇒ Press the **CAL**-key repeatedly until „LSG Set“ is displayed.



⇒ Press the **TARE** key, the currently set density of the auxiliary liquid is displayed. In the upper part of the display panel, the  symbol and the # symbol appear in order to indicate numerical input status. The active digit is flashing.



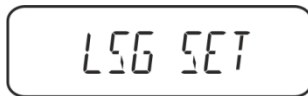
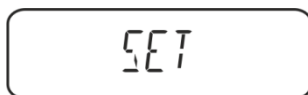
To change with the navigation keys enter density of your auxiliary liquid, see chap. 8.

**UNIT** key: Increase the flashing digit

**PRINT]** key: Digit selection to the right

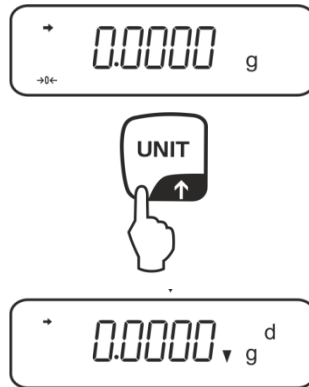
**TARE** key: Confirm entry

⇒ Back to menu / weighing mode, press **ON/OFF** key repeatedly



### 5.3.3 Determine density of sinking solid bodies ( $d > 1 \text{ g/cm}^3$ )

1. Remove the immersion basket and place the glass beaker filled with the auxiliary liquid in the centre of the platform. Filling height should be approx.  $\frac{3}{4}$  of the capacity. Make sure that it has no contact with the frame. Remount the immersion basket. Make sure that it does not touch the glass beaker. Set balance to zero. Press the **UNIT** key repeatedly, until the balance is in mode of density determination of solid material.

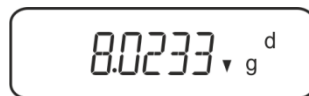


2. Place sample of solid material in the upper sample dish, see fig. 1, chap. 5.1.2.



The weight of the „sample in air“ is displayed.

3. Wait for stability display (→), then press the **CAL** key.
4. Place sample of solid material in the lower sifting bowl, see fig. 2, chap. 5.1.2.. For this remove the immersion basket out from the frame. Always ensure that, when re-immersing into the liquid, no additional bubbles adhere; it is better to use pincers or alike to place the sample directly on the sifting bowl. Make sure that the sample is at least 1 cm immersed.



The weighing balance will first determine then display the sample's density.

5. If you connect an optional printer you can print the result.
6. Remove the sample. To carry out further measuring, press the **CAL**-key and start with step 2.



To avoid corrosion, don't leave the density set immersed in liquid for a long time.

### Printout example KERN YKB-01N:

KERN & Sohn GmbH	Company
TYPE ACS 320-4	Model
SN WB11AG0002	Serial no.
ID 1234	Balance identification no.
1.2188DS	Result
-SIGNATURE-	prepared by
-----	

#### 5.3.4 Determine density of floating solid bodies ( $d < 1 \text{ g/cm}^3$ )

At solid material with density less than  $1 \text{ g/cm}^3$ , a density determination with two different methods is possible.

##### Method 1:

How to carry out see chap. 5.2.3.

As aid liquid is used a liquid with less density than that of the solid material, e.g. ethanol approx.  $0.8 \text{ g/cm}^3$ .

This method should be applied when the density of the solid is just slightly different from that of the distilled water.

Using ethanol is not recommended, when the solid material is being attacked.



When working with ethanol, you must observe the applicable safety regulations.



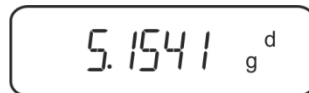
## Method 2:

- ⇒ Make sure that the balance is in the mode for density determination of solid material (see chap. 5.2.1).

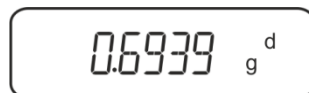


If weighing balance does not show Zero, press **TARE**.

- ⇒ Place solid material into the upper sample dish see fig. 3, chap. 5.1.3. The weight of the sample in air is displayed



- ⇒ Wait for stability display (→), then press the **CAL** key.
- ⇒ Place the solid material entirely **under** the lower sifting bowl, see fig. 3, chap. 5.1.3. For this purpose remove the immersion basket and for re-immersing keep the sample possibly free of bubbles. Or if possible place the sample using pincers or alike directly under the sifting bowl.



The weighing balance will first determine then display the sample's density.

- ⇒ If you connect an optional printer you can print the result.
- ⇒ Remove the sample. To carry out further measuring, press the **CAL**-key and start with step 2.

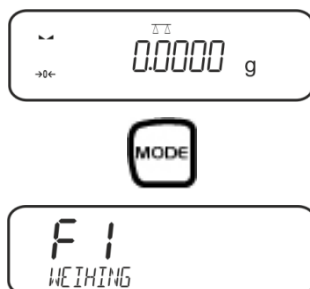




To avoid corrosion, don't leave the density set immersed in liquid for a long time.

## 5.4 Series KERN AES-C


### 5.4.1 Invoke mode for density determination of solid material

⇒ In weighing mode press the **MODE** key, „F1 WEIGHING“ will be displayed.



⇒ Press   repeatedly until the density determination function for solid material „F6“ is displayed.



⇒ Press , from here on the balance is in the mode for density determination of solid material.




**Enter density of the auxiliary liquid:**





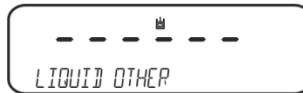
⇒ Press .




⇒ Press , the currently set auxiliary liquid is displayed.



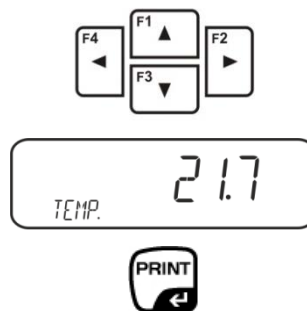
⇒ To change, press   until the desired auxiliary liquid is displayed.



⇒ Acknowledge selection by  .

### Either

If **WATER** or **ETHANOL** is selected, read the temperature on the thermometer and enter it (the active digit is flashing).

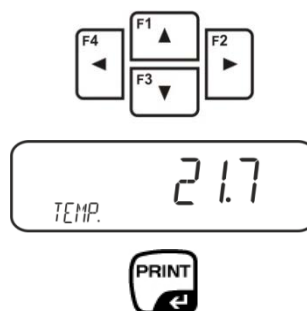


Confirm input with **PRINT** key, the balance changes into the mode for density determination of solid material.



or

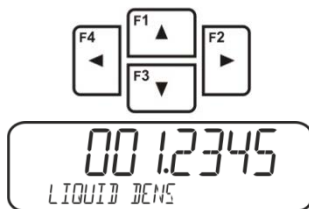
When selecting "OTHER" enter temperature of auxiliary fluid of your choice. (the active digit is flashing).



Confirm input with **PRINT** key, the currently set density of the auxiliary liquid is displayed. The active digit is flashing.



Use the navigation keys to enter the density of the auxiliary liquid of your choice.



Confirm input with **PRINT** key, the balance changes into the mode for density determination of solid material.



## 5.4.2 Determine density of sinking solid bodies ( $d > 1 \text{ g/cm}^3$ )


- ⇒ Remove the immersion basket and place the glass beaker filled with the auxiliary liquid in the centre of the platform. Filling height should be approx.  $\frac{3}{4}$  of the capacity. Make sure that it has no contact with the frame. Remount the immersion basket. Make sure that it does not touch the glass beaker. Set balance to zero.




- ⇒ Place sample of solid material in the upper sample dish, see fig. 1, chap. 5.1.2.



The weight of the „sample in air“ is displayed.

- ⇒ Wait for stability display (▬▬), then press .
- ⇒ Place sample of solid material in the lower sifting bowl, see fig. 2, chap. 5.1.2.. For this remove the immersion basket out from the frame. Always ensure that, when re-immersing into the liquid, no additional bubbles adhere; it is better to use pincers or alike to place the sample directly on the sifting bowl. Make sure that the sample is at least 1 cm immersed.

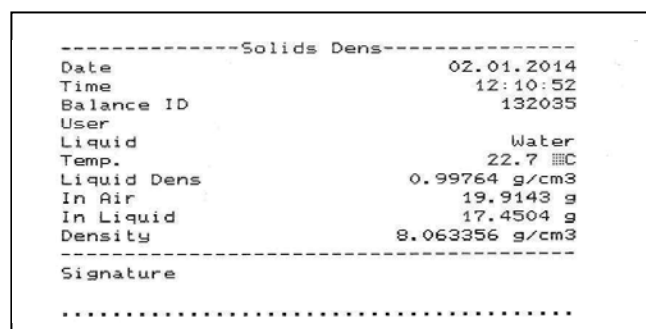


- ⇒ Wait for stability display (▬▬), then press .
- The weighing balance will first determine then display the sample's density.



- ⇒ When connecting an optional printer, the result will be printed out.

### Printout example KERN YKB-01N:



- ⇒ Remove the sample. For additional measures press the UNIT key.

### 5.4.3 Determine density of floating solid bodies ( $d < 1 \text{ g/cm}^3$ ):

At solid material with density less than  $1 \text{ g/cm}^3$ , a density determination with two different methods is possible.

#### Method 1:

How to carry out see chap. 5.3.2.

As aid liquid is used a liquid with less density than that of the solid material, e.g. ethanol approx.  $0.8 \text{ g/cm}^3$ .

This method should be applied when the density of the solid is just slightly different from that of the distilled water.

Using ethanol is not recommended, when the solid material is being attacked.



When working with ethanol, you must observe the applicable safety regulations.

#### Method 2:

- ⇒ Make sure that the balance is in the mode for density determination of solid material (see chap. 5.3.1).




Set balance to zero.

- ⇒ Place sample of solid material in the upper sample dish, see fig. 3, chap. 5.1.3.



The weight of the „sample in air“ is displayed.

- ⇒ Wait for stability display (▲▲), then press .
- ⇒ Place the solid material entirely **under** the lower sifting bowl, see fig. 3, chap. 5.1.3.

For this purpose remove the immersion basket and for re-immersing sink the sample in the liquid.

Or if possible place the sample using pincers or alike directly under the sifting bowl.



The weighing balance will first determine then display the sample's density.



- ⇒ If you connect an optional printer you can print the result.

## 5.5 Series KERN ALS-A

### 5.5.1 Determine density of sinking solid bodies ( $d > 1 \text{ g/cm}^3$ )

- ⇒ Remove the immersion basket and place the glass beaker filled with the auxiliary liquid in the centre of the platform. Filling height should be approx.  $\frac{3}{4}$  of the capacity. Make sure that it has no contact with the frame. Remount the immersion basket. Make sure that it does not touch the glass beaker.

- ⇒ In weighing mode press **MENU** button. The first menu item „count“ is displayed.

A rectangular digital display showing the word "Count" in a large, black, monospaced font.

- ⇒ Press **MENU** button

A rectangular digital display showing "dEnS" in a large, black, monospaced font.

- ⇒ Acknowledge using **PRINT** button, the current setting is displayed.

- ⇒ Using **MENU** button select „d SoLid“

A rectangular digital display showing "dSoL id" in a large, black, monospaced font.

- ⇒ Confirm by pressing the **PRINT** button. The currently set density of the aid liquid is displayed (factory setting  $1.0000 \text{ g/cm}^3$  for distilled water at  $20^\circ\text{C}$ ).

A rectangular digital display showing "dL 1.0000" in a large, black, monospaced font.

- ⇒ To change, enter the density of the aid liquid using arrow keys  $\downarrow$   $\uparrow$   $\leftarrow$ .

- ⇒ Confirm input by pressing the **PRINT** button.

- ⇒ The display for weight determination of the "sample in air" appears.

A rectangular digital display showing "UE , A ir" in a large, black, monospaced font.

- ⇒ Confirm by pressing the **PRINT** button.

- ⇒ Should the balance not show Zero, press the **TARE** button.

- ⇒ Place sample of solid material in the upper sample dish, see fig. 1, chap. 5.1.2.

- ⇒ Wait for stability display (\*), then press .

- ⇒ Wait until the display for weight determination of „sample in aid liquid“ appears.

A rectangular digital display showing "UE , LI 9" in a large, black, monospaced font.

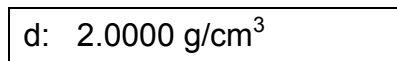
- ⇒ Confirm by pressing the **PRINT** button.

- ⇒ Place sample of solid material in the lower sifting bowl, see fig. 2, chap. 5.1.2.. For this remove the immersion basket out from the frame. Always ensure that, when re-immersing into the liquid, no additional bubbles adhere; it is better to use pincers or alike to place the sample directly on the sifting bowl. Make sure that the sample is at least 1 cm immersed.
- ⇒ Wait for stability display [**\***], then take over the weight value „sample in aid liquid“ using the **PRINT** button. The density of the sample is shown.



- ⇒ When an optional printer is connected, the displayed value can be edited using the **PRINT** button.

**Printout example (KERN YKB-01N):**



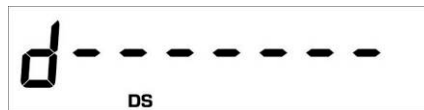
**Return to weighing mode**

- ⇒ Press the **ON/OFF** key



- ⇒ or use the **MENU** button to start a new measuring cycle.

If at the density determination errors have appeared, „d-----“, is displayed.



To avoid corrosion, don't leave the density set immersed in liquid for a long time.



### 5.5.2 Determine density of floating solid bodies ( $d > 1 \text{ g/cm}^3$ ):

At solid material with density less than  $1 \text{ g/cm}^3$ , a density determination with two different methods is possible.

#### Method 1:

How to carry out see chap. 5.3.2.

As aid liquid is used a liquid with less density than that of the solid material, e.g. ethanol approx.  $0.8 \text{ g/cm}^3$ .

This method should be applied when the density of the solid is just slightly different from that of the distilled water.

Using ethanol is not recommended, when the solid material is being attacked.



When working with ethanol, you must observe the applicable safety regulations.

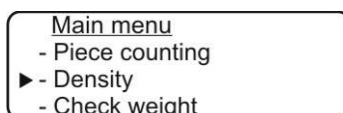
#### Method 2:

⇒ How to carry out see chap. 5.4.1. in the weighing „Sample in auxiliary liquid“ do not place the sample upon, but **under** the sifting bowl, see fig. 4, chap. 5.1.3.

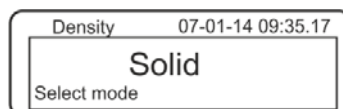
## 5.6 Series KERN ALT-B

### 5.6.1 Determine density of sinking solid bodies ( $d > 1 \text{ g/cm}^3$ )

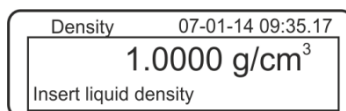
- ⇒ Remove the immersion basket and place the glass beaker filled with the auxiliary liquid in the centre of the platform. Filling height should be approx.  $\frac{3}{4}$  of the capacity. Make sure that it has no contact with the frame. Remount the immersion basket. Make sure that it does not touch the glass beaker.
- ⇒ In weighing mode press **MENU** button. The master menu will be displayed.
- ⇒ Use the navigation buttons  $\uparrow$  to select the menu item „Density“.



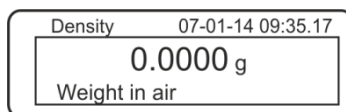
- ⇒ Acknowledge using **PRINT** button, the current setting is displayed.
- ⇒ Use the navigation buttons  $\uparrow$  to select setting „Solid body“.



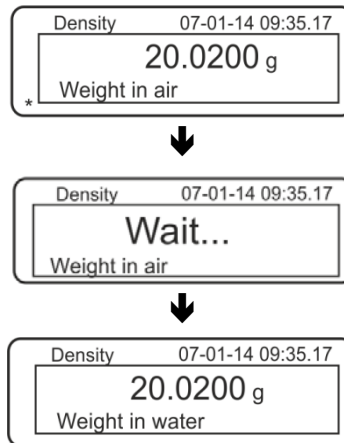
- ⇒ Confirm using the **PRINT** button, the set density of the aid liquid is displayed (factory setting  $1.0000 \text{ g/cm}^3$  for distilled water at  $20^\circ\text{C}$ ).



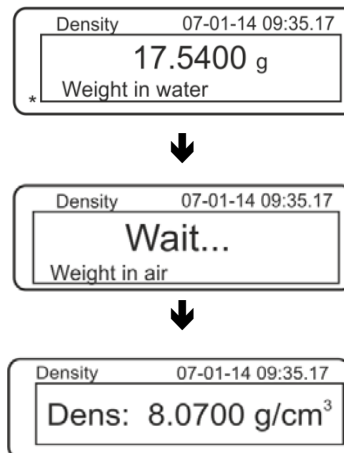
- ⇒ To change press **TARE** key (see chap. 8). Use the navigation buttons  $\uparrow$  to increase/reduce the digit. Use the **TARE** button to select the next digit. Repeat this sequence for each digit. To delete keep pressed the **TARE** button.
- ⇒ Confirm entry with **PRINT** button, the display for calculation of „Weight in air“ is displayed.  
Should the balance not show Zero, press the **TARE** button.



- ⇒ Place sample of solid material in the upper sample dish, see fig. 1, chap. 5.1.2.
- ⇒ Wait for stability display [**\***], then take over the weight value using the **PRINT** button.



- ⇒ Wait until the display for determination of „sample in aid liquid“ appears. Remove the sample and if required tare by using the **TARE** button.
- ⇒ Lay the sample into the lower sample dish and immerse it in the aid liquid trying to avoid bubble formation. Make sure that the sample is at least 1 cm immersed.
- ⇒ Wait for stability display [**\***], take over the weight value using **PRINT** button. The density of the sample is shown.



- ⇒ When an optional printer is connected, the displayed value can be edited using the **PRINT** button.

Printout example (KERN YKB-01N):

```

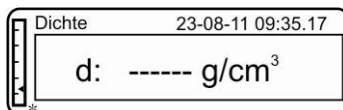
.....
07-01-14  09:35:17
.....
d:  8.0700 g/cm3

```

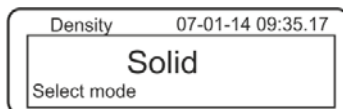


To avoid corrosion, don't leave the density set immersed in liquid for a long time.

If at the density determination errors have appeared, „d-----“, is displayed.



⇒ For further measurements go back to density determination mode, press **MENU** button.



⇒ Back to weighing mode, press **ON/OFF** button.



### 5.6.2 Determine density of floating solid bodies ( $d < 1 \text{ g/cm}^3$ ):

At solid material with density less than  $1 \text{ g/cm}^3$ , a density determination with two different methods is possible.

#### Method 1:

How to carry out see chap. 5.5.1.

As aid liquid is used a liquid with less density than that of the solid material, e.g. ethanol approx.  $0.8 \text{ g/cm}^3$ .

This method should be applied when the density of the solid is just slightly different from that of the distilled water.

Using ethanol is not recommended, when the solid material is being attacked.



When working with ethanol, you must observe the applicable safety regulations.

#### Method 2:



⇒ How to carry out see chap. 5.5.1. In the weighing „Sample in auxiliary liquid“ do not place the sample upon, but **under** the sifting bowl, see fig. 4, chap. 5.1.3.

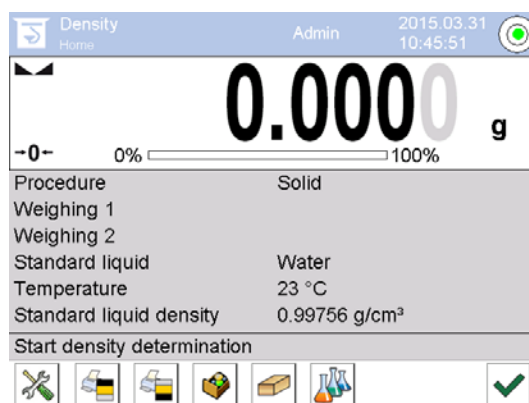
## 5.7 Series KERN AET

### Preparation:




<p>AET 200-4NM AET 500-4</p>	<ul style="list-style-type: none"> <li>⇒ Disconnect scale from power supply</li> <li>⇒ Remove standard weighing plate</li> <li>⇒ Installing the density determination set, see chap. 4.3.2.</li> </ul>
<p>AET 100-5M AET 200-5DM</p>	<ul style="list-style-type: none"> <li>⇒ Don't disconnect scale from power supply</li> <li>⇒ Carefully remove standard weighing plate while the instrument is on.</li> <li>⇒ Installing the density determination set while the instrument is on see chap. 4.3.2</li> <li>⇒ Set balance to zero.</li> </ul>

### Selecting density application:




For instance, tap the icon  in the top left corner of the display window and select application density .



The factory configuration provides enabled special function keys

<    > as well as a special info box for percentage determination.

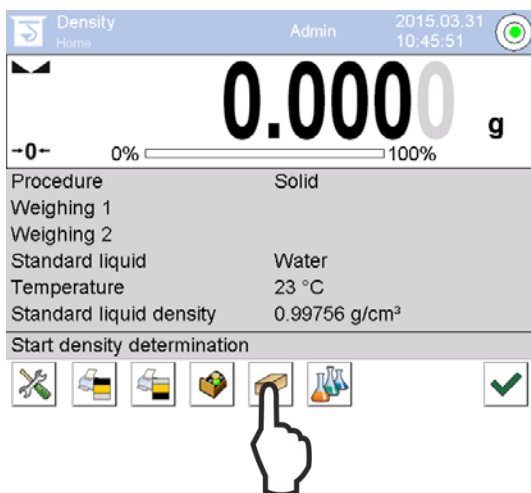
### Special function keys:


	Density determination of solids, see chap. 5.6.2
	Density determination of liquids see chap. 6.6.2
	Start measurement

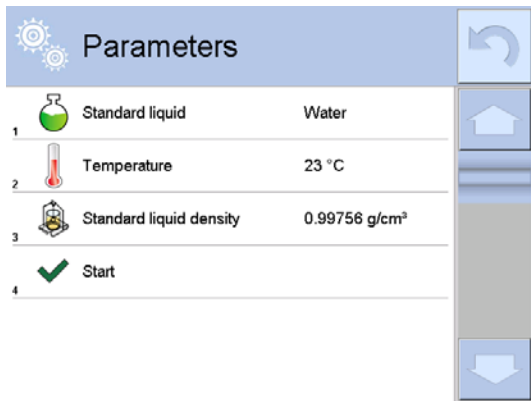
### Special info boxes:

<b>Sequence of operations</b>	Selected type of density determination (Method “solids“ or “liquids“)
<b>Weighing process 1</b>	Weighing of sample in air
<b>Weighing process 2</b>	Weighing of sample in liquid
<b>Reference liquid</b>	Auxiliary liquid (distilled) water, ethanol or fluid of your choice of known density.
<b>Temperature</b>	Temperature of auxiliary liquid.
<b>Density of</b>	<ul style="list-style-type: none"> <li>➤ For density determination of solids: Density of auxiliary liquid (for water or ethanol determined automatically from the integrated density tables and then displayed)</li> <li>➤ For density determination of liquids: Volume of plummet</li> </ul>

#### 5.7.1 Invoke mode for density determination of solid material and enter parameters of the auxiliary liquid



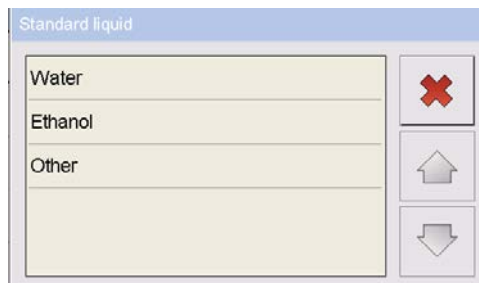
⇒ To select method “solids“, press the function key 



⇒ The parameter menu for the auxiliary liquid will be displayed.



### Auxiliary fluid

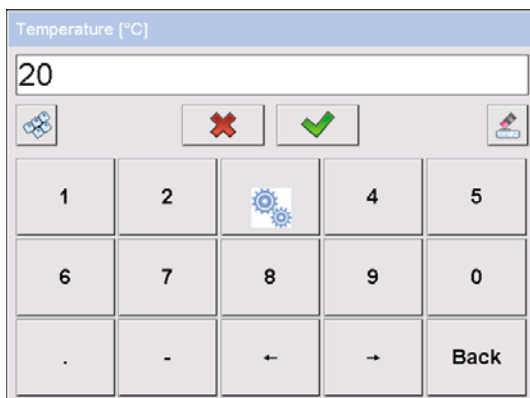


⇒ To select the auxiliary liquid, tap **<Reference liquid>**.

1. When selecting **<Water>** or **<Ethanol>** enter the auxiliary liquid at the next step.
2. When selecting **<Other>** enter the known density for the auxiliary liquid at the next step.



### Temperature



When selecting **<Water>** or **<Ethanol>** as auxiliary liquid the temperature is entered during this step.

⇒ Tap **<Temperature>**.

⇒ In the numeric input window

Enter the temperature for the auxiliary liquid in and confirm by



## Density of reference liquid

1. When selecting **Water** or **Ethanol**, their density will be automatically determined from the integrated density tables and displayed:

Parameters	
1	Standard liquid: Water
2	Temperature: 20 °C
3	Standard liquid density: 0.99823 g/cm <sup>3</sup>
4	Start

2. When selecting **Other** tap the **<Density of reference liquid>** command button:

Parameters	
1	Standard liquid: Other
2	Temperature: 20 °C
3	Standard liquid density: 0.99823 g/cm <sup>3</sup>
4	Start

- ⇒ Enter the known density for the auxiliary liquid in the numeric input window and confirm by

Standard liquid density [g/cm<sup>3</sup>]

0.98773

1	2	3	4	5
6	7	8	9	0
.	-	←	→	Back

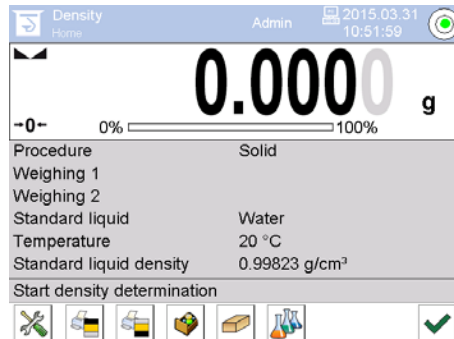


Press the function key to start density determination.



### 5.7.2 Determine density of sinking solid bodies ( $d > 1 \text{ g/cm}^3$ )

1. Remove the immersion basket and place the glass beaker filled with the auxiliary liquid in the centre of the platform. Filling height should be approx.  $\frac{3}{4}$  of the capacity. Make sure that it has no contact with the frame. Remount the immersion basket. Make sure that it does not touch the glass beaker. Set balance to zero.

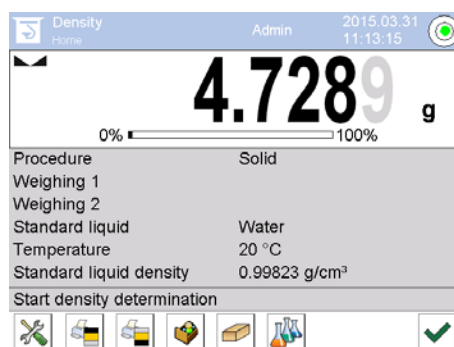



2. Place solids in the upper sample dish.

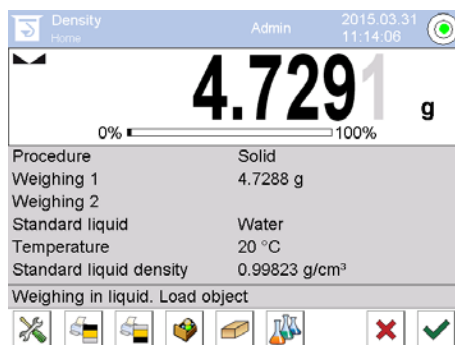


Fig.1: "Weighing in air"

The weight of the „sample in air“ is displayed.



- Wait for stability display and confirm by . The weight value “sample in air” will be displayed under <weighing process 1>.

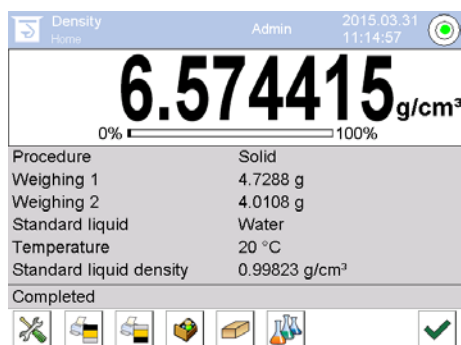



- Place solids in the lower filter dish.  
For this remove the immersion basket out from the frame. Always ensure that, when re-immersing into the liquid, no additional bubbles adhere; it is better to use pincers to place the sample directly on the sifting bowl. Make sure that the sample is at least 1 cm immersed.



Fig. 2: “Weighing in auxiliary liquid”

- Wait for stability display and confirm by . The weighing scale first determines, then displays the solid matter’s density.



9. When connecting an optional printer, the result will be printed out. Printout example see chap. 5.6.4.
10. Finish process by . Remove the sample.  
Start more measurements at step 2.



To avoid corrosion damage, don't leave the immersion basket immersed in liquid for a long time.

### 5.7.3 Determine density of floating solid bodies ( $d < 1 \text{ g/cm}^3$ )

At solid material with density less than  $1 \text{ g/cm}^3$ , a density determination with two different methods is possible.

#### Method 1:

Implementation see chap. 5.6.2

As aid liquid is used a liquid with less density than that of the solid material, e.g. ethanol approx.  $0.8 \text{ g/cm}^3$ .

This method should be applied when the density of the solid is just slightly different from that of the distilled water.

Using ethanol is not recommended, when the solid material is being attacked.



When working with ethanol, you must observe the applicable safety regulations.

#### Method 2:

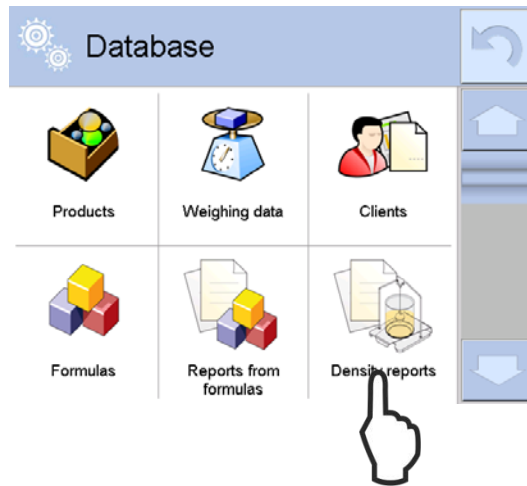
Implementation see chap. 5.6.2, for "step 4" place sample **underneath** instead of in the filter dish.

## 5.7.4 Log density determination

### Printout example default report (KERN YKB-01N)

----- Density -----	
----- Solid -----	
Operator	Admin
Balance ID	132012
Date	2015.03.05
Time	11:12:30
Standard liquid	Water
Temperature	20°C
Standard liquid density	0.99823 g/cm <sup>3</sup>
Weighing 1	6.757 g
Weighing 2	4.999 g
Density	3.836769 g/cm <sup>3</sup>
-----	
Signature	
.....	

If a measurement report is printed, the data record will automatically be saved to the database under **<Density reports>**.



	Date and Time	Density
1	2015.03.31 11:08:14	12.92708 g/cm <sup>3</sup>
2	2015.03.31 11:11:35	12.92969 g/cm <sup>3</sup>
3	2015.03.31 11:12:18	6.469482 g/cm <sup>3</sup>
4	2015.03.31 11:13:41	6.574415 g/cm <sup>3</sup>

To **<Open/Print>** press and hold your finger on the desired data record until the context menu appears.

Open  
Print  
Cancel

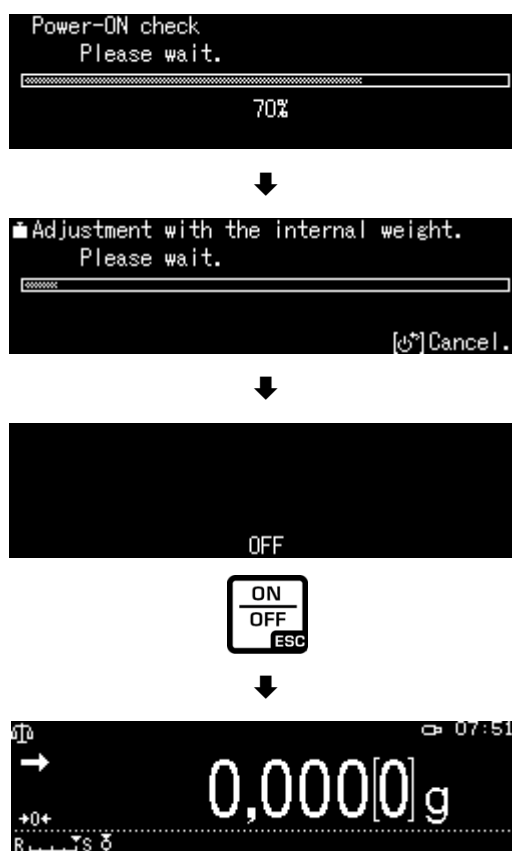


Field	Value
00285 Sample number	
1 Start date	2015.03.31 11:13:41
2 End date	2015.03.31 11:14:55
3 Density	6.574415 g/cm <sup>3</sup>
4 Volume	0.71927 cm <sup>3</sup>
5 Procedure	Solid

## 5.8 KERN ABP Series

### 5.8.1 Installing the density determination set

- ⇒ Insert frame in the weighing compartment. The round opening above at the frame has to point into the direction where the immersion basket is inserted from.
- ⇒ Put the supporting platform of the glass beaker through the frame on the weighing compartment floor. Place it in a way that it does not touch the frame.
- ⇒ Place compensation weights [Nr. 1] on the frame, see allocation list chap.4.1
- ⇒ Close the glass doors. Connect the balance to the power supply and switch on. When the log-in function is enabled, use the navigation keys to select the respective user and enter password.



- ⇒ Bring liquid and instruments to the right temperature until you achieve a constant temperature. Observe the warm-up time of the balance.

## 5.8.2 Parameter setting

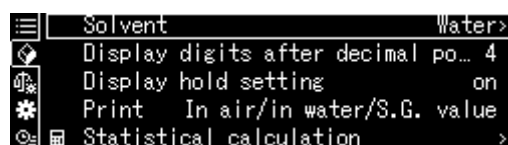
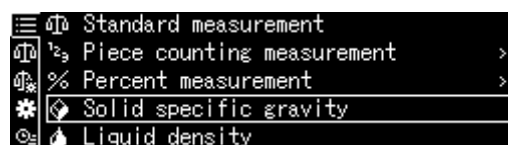
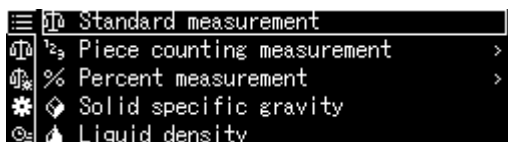
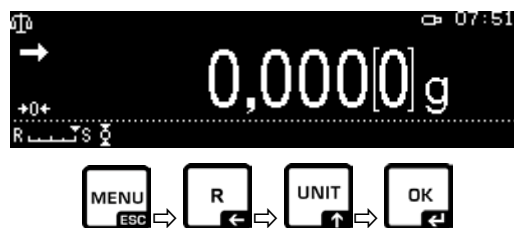
### 5. Choice of the application

⇒ Using navigation buttons  $\uparrow$   $\downarrow$ , select <Solid specific gravity>. The selected option is indicated by a frame. Press OK to confirm.

⇒ Press MENU button to display the configuration menu.

### 6. Introducing auxiliary liquid parameters

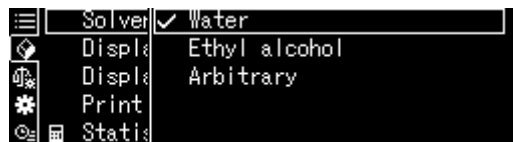
⇒ Using navigation buttons  $\uparrow$   $\downarrow$ , select <Solvent> and press OK to confirm.



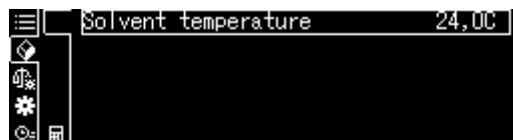
⇒ Using navigation buttons  $\uparrow$   $\downarrow$ , select the auxiliary liquid and press OK to confirm.

3. If you select **<Water>** or **<Ethyl alcohol>**, enter the auxiliary liquid temperature in the next step.

4. If you select **<Arbitrary>**, enter the known auxiliary liquid density.

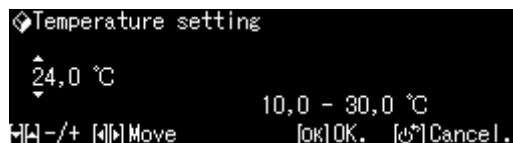


Selection of **<Water>** or **<Ethyl alcohol>**



⇒ Read the temperature on the thermometer and enter it, using navigation buttons. Press **OK** to confirm.

The corresponding density will be determined by the balance based on the integrated density table.



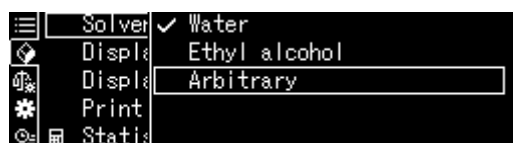
⇒ Press **R** to return to the menu.



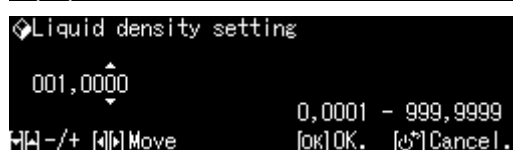


---

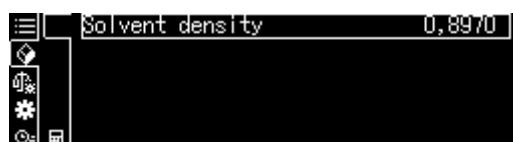
## Selection of <Arbitrary>



- ⇒ Using navigation buttons, enter the known density of the selected auxiliary liquid. Press OK to confirm.



- ⇒ Press **R** to return to the menu.



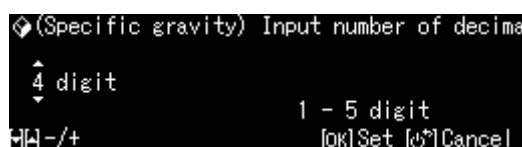
---

## 7. Number of decimal places

- ⇒ Using navigation buttons **↑** **↓**, select <Display digits after decimal po...> and press OK to confirm.

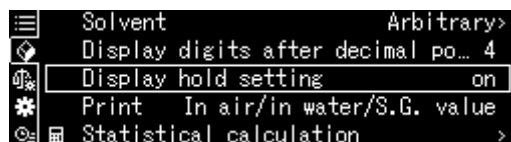


- ⇒ Using navigation buttons **↑** **↓**, select the number of decimal places and press OK to confirm.

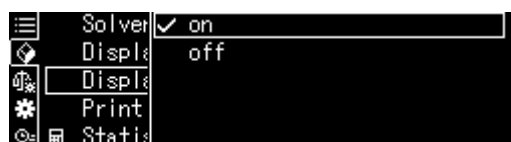


## 8. "Hold" function

⇒ Using navigation buttons  $\uparrow$   $\downarrow$ , select <Display hold setting> and press OK to confirm.

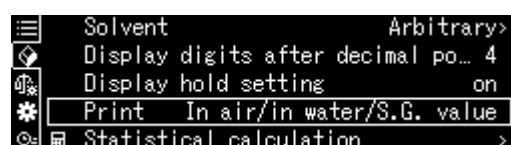


⇒ Using navigation buttons  $\uparrow$   $\downarrow$ , select the option ON or OFF and press OK to confirm.  
 With the activated function, the first displayed result value will be displayed on the screen until it is reset using OK button.

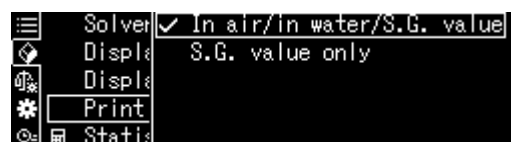


## 9. Data transmission

⇒ Using navigation buttons  $\uparrow$   $\downarrow$ , select <Print> and press OK to confirm.



⇒ Apply the selected setting, pressing OK.



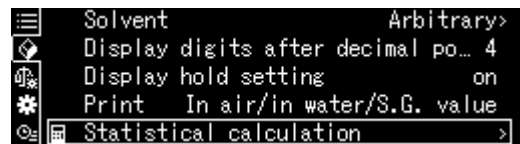
**Protocol template  
<In air/in water/S.G. value>**

**Protocol template  
<S.G. value only>**

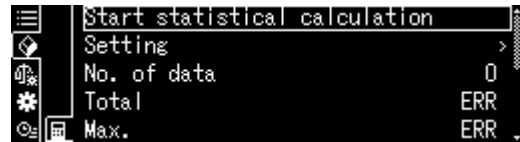
SOLID SPECIFIC GRAVITY DATE 2018 Nov. 14 TIME 10.20.24	SOLID SPECIFIC GRAVITY DATE 2018 Nov. 14 TIME 10.20.24
L.DENS= 0.99730 g/cm <sup>3</sup> AIR= 20.0006 g WATER= 17.5017 g DS= 7.9954 DS=	DS = 7.9954 DS

## 10. Statistics

⇒ Using navigation buttons  $\uparrow$   $\downarrow$ , select <Statistical calculation> and press OK to confirm.



⇒ The consecutive steps should be performed according to the balance operating manual, see chapter "Statistics".




⇒ Press **ON/OFF** to return to the density determination mode.



**i** To switch between the "Density determination mode"  $\leftrightarrow$  and the "Weighing mode", press **F**.

### 5.8.3 Determining density of sinking solid bodies ( $d > 1 \text{ g/cm}^3$ )

1. Place a beaker filled with the auxiliary liquid in the platform centre. It should be filled to ca.  $3/4^{\text{th}}$  of its capacity. It should not touch the stand. Attach the dipper basket. It should not touch the beaker. Press **TARE** to reset the balance.
2. Ensure the balance is in the  Solid specific gravity mode (see chapter 5.7.2).



3. Place the solid body on the upper sample pan.



Fig. 1: Weighing in the air

The sample weight in the air will be displayed.



4. Wait until the stabilisation indicator is displayed (→), then press OK to take over the weighed value.

- Place the solid body on the lower strainer pan.  
To do it, remove the dipper basket from the stand. When submerging in the liquid again, no extra air bubbles should be created. It is best to apply the sample using tweezers or place it directly on the strainer pan. The sample must be submerged at least 1 cm deep.



Fig. 2: Weighing in the auxiliary liquid

The sample weight in the auxiliary liquid will be displayed.



- Wait until the stabilisation indicator is displayed (→), then press OK to take over the weighed value. The density of the solid will be determined by the balance taking into account aerodynamic displacement, and then displayed.



- The result can be printed after an optional printer has been connected.
- Remove the sample. To perform consecutive measurements, press **OK** and start the procedure from step 3.



To prevent corrosion-related damage to the dipper basket, do not leave it submerged in the liquid for an extended period of time.

#### 5.8.4 Determining density of floating solid bodies ( $d < 1 \text{ g/cm}^3$ )

For solid body density below  $1 \text{ g/cm}^3$ , the density can be determined using two different methods.

##### Method 1:

Procedure, see Chapter 5.7.3.

The auxiliary liquid is the one with density below the solid body density, e.g. ethanol, density ca.  $0.8 \text{ g/cm}^3$ .


This method should be used when the solid body density is slightly different from the distilled water density.

Before you use ethanol, check if the solid body does not get damaged.



During any operations entailing ethanol, follow the mandatory safety regulations.

## Method 2:

1. Place a beaker filled with the auxiliary liquid in the platform centre. It should be filled to ca. 3/4<sup>th</sup> of its capacity. It should not touch the stand. Attach the dipper basket. It should not touch the beaker. Reset the balance.
2. Ensure the balance is in the  Solid specific gravity> mode (see chapter 5.7.2).



3. Place the solid body on the upper sample pan.



Fig. 3: Weighing in the air

The sample weight in the air will be displayed.



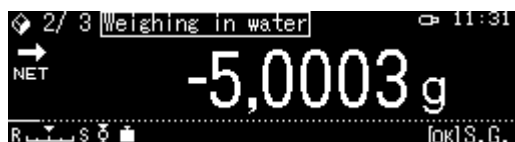
4. Wait until the stabilisation indicator is displayed (➔), then press OK to take over the weighed value.

5. Place the solid body under the lower strainer pan.  
For that purpose, remove the dipper basket and after you have submerged it again, place the sample under the strainer pan, trying to avoid formation of air bubbles.  
Or, whenever possible, use tweezers etc. to place the sample directly under the strainer pan.



Fig. 4: Weighing in the auxiliary liquid

The sample weight in the auxiliary liquid will be displayed.



6. Wait until the stabilisation indicator is displayed (→), then press OK to take over the weighed value. The density of the solid will be determined by the balance taking into account aerodynamic displacement, and then displayed.



7. The result can be printed after an optional printer has been connected.
8. Remove the sample. To perform consecutive measurements, press OK and start the procedure from step 3.



To prevent corrosion-related damage to the dipper basket, do not leave it submerged in the liquid for an extended period of time.



## 6 Determining density of liquids

At the density determination of liquids, a sinker is used whose density is known. The sinker is weighed first in air and then in the liquid whose density is to be determined. From the weight difference results the buoyancy from where the software calculates the density.

Determine the steel sinker volume as described below

Or

Have it determined quickly and not expensively in our calibration DKD laboratory. For more information, visit KERN home page ([www.kern-sohn.com](http://www.kern-sohn.com)).

### 6.1 Determination of the sinker volume

- ⇒ Prepare the balance as described in chapter 4.3.2. "Installation of the density determination kit".
- ⇒ Fill in the container with distilled water. It should be filled to ca. 3/4<sup>th</sup> of its capacity. Adjust temperature until it is stable.
- ⇒ Prepare the sinker.
- ⇒ Read the temperature on the thermometer.

1. Enter the weighing mode and reset whenever required.



2. Place the sinker on the upper sample pan. Wait until the stabilisation indicator is displayed, take down the displayed weight.



3. Place the sinker on the lower sample pan. Wait until the stabilisation indicator is displayed, take down the displayed weight.



The sinker volume is calculated using the following formula:

$$V = \frac{A - B}{\rho_w}$$

- V = sinker volume  
A = sinker weight in the air = 20.0000 g  
B = sinker weight in water = 17.50850 g  
 $\rho_w$  = Water density (see chapter 8) at 20°C = 0.9982 g/cm<sup>3</sup>

$$V = \frac{20.0000 \text{ g} - 17.5085 \text{ g}}{0.9982 \text{ g/cm}^3} = 2.4960 \text{ cm}^3$$

## 6.2 Series KERN ABS-N, ABJ-NM, ACS, ACJ

### 6.2.1 Mode to call up density determination of liquids.

1. Turn on balance by pressing the **ON/OFF** key.



2. Call up menu:  
In weighing mode press the **MENU** button twice.



3. Press the navigation buttons (↓ ↑) repeatedly until „**APL.FUNC**“ is displayed.



4. Press **PRINT**.

5. Press the navigation buttons (↓ ↑) repeatedly until „**SG**“ is displayed. To confirm, press **TARE**, "SET" followed by your current setting will be displayed.

SG, ↓

6. Press the cursor keys (↓ ↑) repeatedly until "L.DENS" ("density determination fluid" mode) appears.

L.DENS, ↓

7. Confirm with **TARE** key. "SET" followed by the display for entering the sinker volume will be displayed.

SET, ↓

SVOLUM, ↓

8. Press **TARE** key and the display will change to numeric data input.  
# indicates that the weighing balance is in numeric input mode. The first digit is flashing and can be changed.  
Using the cursor keys, enter the drop shaft's volume (See chap. 6).

002.493 # ↓

<b>Numeric input</b>	
# indicates that the weighing balance is in numeric input mode. The first digit is flashing and can be changed.	
↑	Increase flashing digit
↓	Decrease flashing digit
→	Digit selection to the right
←	Confirm entry

9. The balance changes into the mode for density determination of liquids.

SET  
↓  
~ 0.0000 g<sup>d</sup>



To change from density mode ⇔ to weighing mode press **MENU** for 3 s.

## 6.2.2 Determining density of the test liquid

1. Fill test liquid into the glass beaker.  
Make sure that the balance is in the mode for density determination of liquids (see chap. 6.1.1).



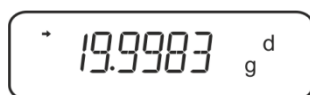
If weighing balance does not show Zero, press **TARE**.

2. Put the sinker into the upper sample dish.



Fig.5: Weighing in air

The weight of the sinker in air will be displayed.



3. Wait until stability display (→) appears, then press **UNIT**. "SINK" will be shown.

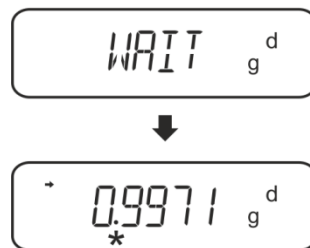


- Put the sinker into the lower sifting bowl.



Fig.6: Weighing in test liquid

The weighing balance will first determine then display the fluid's density.



- If you connect an optional printer you can print the result.

## Printout example KERN YKB-01N:

KERN & Sohn GmbH	Company
TYPE ACS 320-4	Model
SN WB11AG0002	Serial no.
ID 1234	Balance identification no.
0.1109DL	Result
-SIGNATURE-	prepared by
-----	

For further measurements

- ⇒ Clean and dry container and sinker carefully.
- ⇒ Re-attach the sinker
- ⇒ Press the **UNIT**-key
- ⇒ Start with step 2



To avoid corrosion, don't leave the density set immersed in liquid for a long time.

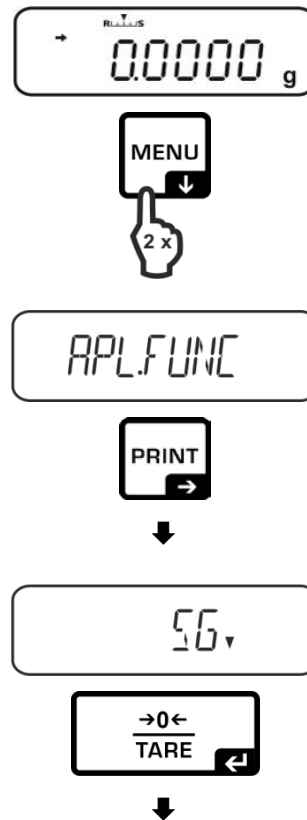
## 6.3 Series KERN TACS / TABJ

- Install the density determination module – see ch. 4.3.2

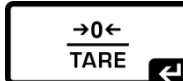
### 6.3.1 Parameter setting

#### 1. Selection of application


- ⇒ Go to the menu:  
In the weighing mode, press the **MENU** button twice.
- ⇒ Press the navigation buttons (↓ ↑) until “APL.FUNC” appears.
- ⇒ Confirm by pressing **PRINT**.
- ⇒ Press the navigation buttons (↓ ↑) until “SG” appears.
- ⇒ Confirm by pressing **TARE**. The display shows “SET” and the current setting.



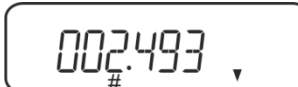
- ⇒ Press the navigation buttons (↓ ↑) until “L.DENS” appears (mode: “Determination of liquid density”).


- ⇒ Confirm by pressing **TARE**. The display shows “SET” and an indication to enter the volume of the plummet.




- ⇒ Confirm by pressing **TARE**. The display changes, so that you can enter a numerical value.




The # symbol shows that the balance is in the mode for entering a numerical value. The first item flashes, and you can change its value. Using navigation buttons, enter the volume of the plummet (see ch. 6.1).

#### Entry of numerical value

The # symbol shows that the balance is in the mode for entering a numerical value. The first item flashes, and you can change its value.

- |   |  |
|---|--|
| ↑ | Increase the value of the flashing digit |
| ↓ | Decrease the value of the flashing digit |
| → | Select the digit on the right            |
| ← | Confirm entered data                     |

- ⇒ The balance switches to the mode for determining the density of liquids.





- i** To switch between the modes “Density determination mode” ⇔ “Weighing mode”, press the **MENU** button and hold it down for 3 s.



## 2. HOLD function <SG.HOLD>

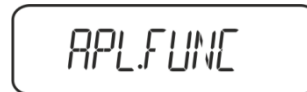
Data-HOLD function can be activated both for the determination of density of solids and liquids.

The displayed density value often fluctuates, and its reading may be difficult. When the function is active, the first result value is shown in the display until it is cancelled with the **UNIT** button.

⇒ Go to the menu:  
In the weighing mode, press the **MENU** button twice.



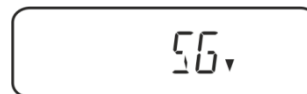
⇒ Press the navigation buttons (↓ ↑) until "APL.FUNC" appears.



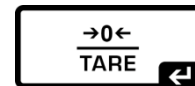
⇒ Confirm by pressing PRINT.



⇒ Press the navigation buttons (↓ ↑) until "SG" appears.



⇒ Confirm by pressing **TARE**. The display shows "SET" and the current setting.

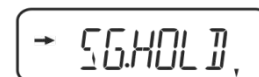
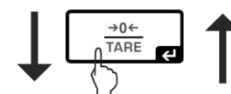


⇒ Press the navigation buttons (↓ ↑) until "SG.HOLD" appears.



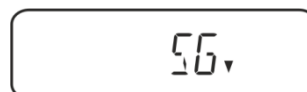
⇒ Confirm by pressing **TARE**.

⇒ By pressing **TARE**, select between the settings "OFF" and "ON". The current setting is marked by the stabilization indicator.



Stabilization indicator	→ "SG.HOLD" setting
OFF	OFF
ON	ON

⇒ Go back to the menu by pressing **ON/OFF** and enter other settings.



or

⇒ Go back to the density determination mode by repeatedly pressing the **ON/OFF** button.

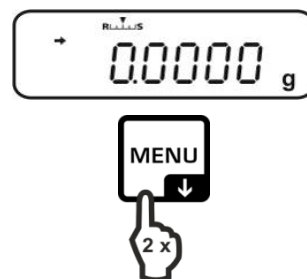


### 3. Air resistance correction <AIR.COR>

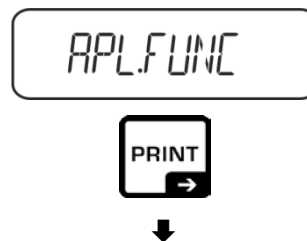
The balance offers a possibility to perform density calculations with and without correction for air resistance.

	"AIR.COR" setting	
	OFF Calculation without air resistance correction *Factory setting	ON Calculation with air resistance correction
Determination of density of liquids	$\rho = \frac{A-B}{V}$ <p>           ρ Density of test liquid            A Mass of plummet in air            B Mass of plummet in test liquid            V Plummet density         </p>	$\rho = \frac{A-B}{V} + \rho_{\alpha}$ <p>           ρ Density of test liquid            A Mass of plummet in air            B Mass of plummet in test liquid            V Plummet density            ρ<sub>α</sub> Air density (0.0012 g/cm<sup>3</sup>)         </p>

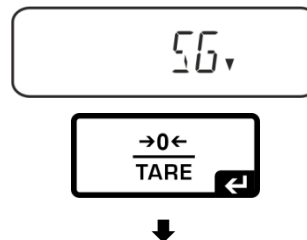
⇒ Go to the menu:  
In the weighing mode, press the **MENU** button twice.



- ⇒ Press the navigation buttons (↓ ↑) until “APL.FUNC” appears.
- ⇒ Confirm by pressing **PRINT**.



- ⇒ Press the navigation buttons (↓ ↑) until “SG” appears.
- ⇒ Confirm by pressing **TARE**. The display shows “SET” and the current setting.

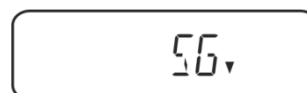


- ⇒ Press the navigation buttons (↓ ↑) until “AIR.COR” appears.
- ⇒ Confirm by pressing **TARE**.
- ⇒ By pressing **TARE**, select between the settings “OFF” and „ON”. The current setting is marked by the stabilization indicator.



Stabilization indicator	“AIR.COR” setting
OFF	OFF
ON	ON

- ⇒ Go back to the menu by pressing **ON/OFF** and enter other settings.



or

- ⇒ Go back to the density determination mode by repeatedly pressing the **ON/OFF** button.



### 6.3.2 Determining density of the test liquid

1. Fill test liquid into the glass beaker.  
Make sure that the balance is in the mode for density determination of liquids (see chap.6.3.1).



If weighing balance does not show Zero, press **TARE**.

2. Put the sinker into the upper sample dish.



Fig.5: Weighing in air

The weight of the sinker in air will be displayed.



3. Wait until stability display (→) appears, then press **UNIT**. "SINK" will be shown.

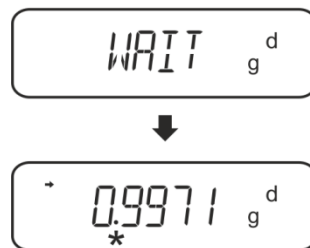


- Put the sinker into the lower sifting bowl.



Fig.6: Weighing in test liquid

The weighing balance will first determine then display the fluid's density.



- If you connect an optional printer you can print the result.

## Printout example KERN YKB-01N:

KERN & Sohn GmbH	Company
TYPE ACS 200-4	Model
SN WB19AG0002	Serial no.
ID 1234	Balance identification no.
0.1109DL	Result
-SIGNATURE-	prepared by
-----	

For further measurements

- ⇒ Clean and dry container and sinker carefully.
- ⇒ Re-attach the sinker
- ⇒ Press the **UNIT**-key
- ⇒ Start with step 2

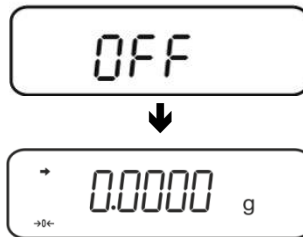


To avoid corrosion, don't leave the density set immersed in liquid for a long time.

## 6.4 Series KERN ABT

### 6.4.1 Mode to call up density determination of liquids.

⇒ Turn on balance by pressing the **ON/OFF** key.



⇒ Call up menu:

In weighing mode press the **CAL** key repeatedly until „FUnC.SEL“ is displayed.



⇒ Press the **TARE** key.



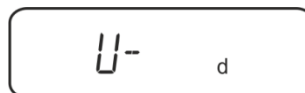
⇒ Press the **CAL** button repeatedly until „Unit.SEL“ will be displayed.



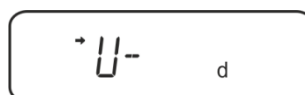
⇒ Press the **TARE** key.



⇒ Press **CAL** key repeatedly until „U- d“ (mode "density determination liquid") is displayed.



⇒ Make sure that the stability display (→) appears, if not, confirm with the **TARE** key.



⇒ Back to menu / weighing mode, press **ON/OFF** key repeatedly





## 6.4.2 Enter density of the sinker



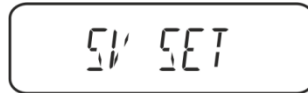
⇒ In weighing mode press the **CAL** key repeatedly until „SettinG“ is displayed.



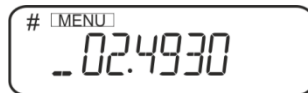
⇒ Press the **TARE** key.



⇒ Press the **CAL** key repeatedly until „Sv Set“ is displayed.



⇒ Press the **TARE** button, the currently set sinker volume is displayed. In the upper part of the display panel, the **[MENU]** symbol and the # symbol appear in order to indicate numerical input status. The active digit is flashing.



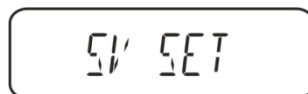
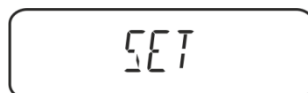
For changes, enter sinker volume using the navigation keys.

**UNIT** key: Increase the flashing digit

**PRINT** key: Digit selection to the right

**TARE** key: Confirm entry

⇒ Back to menu / weighing mode, press **ON/OFF** key repeatedly



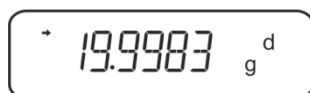
### 6.4.3 Determining density of the test liquid

1. Fill test liquid into the glass beaker.  
Make sure that the balance is in the mode for density determination of liquids (see chap. 6.2.1).



If weighing balance does not show Zero, press **TARE**.

2. Place sinker in the upper sample dish, see fig. 5, chap. 6.1.2.



The weight of the sinker in air will be displayed.

3. Wait for stability display (→), then press the **CAL** key.
4. Place sinker in the lower sifting bowl, see fig. 6, chap. 6.1.2..

The weighing balance will first determine then display the fluid's density.



5. If you connect an optional printer you can print the result.

For further measurements

- ⇒ Clean and dry container and sinker carefully.
- ⇒ Re-attach the sinker
- ⇒ Press the **CAL** key
- ⇒ Start with step 2

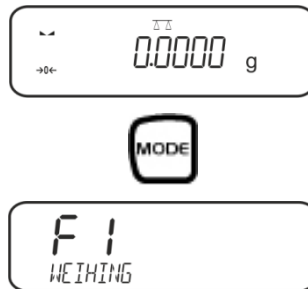



To avoid corrosion, don't leave the density set immersed in liquid for a long time.

## 6.5 Series KERN AES-C


### 6.5.1 Mode to call up density determination of liquids.

⇒ In weighing mode press the **MODE** key, „F1“ will be displayed.



Press  repeatedly until the density determination function for liquids „F7“ is displayed.



⇒ Press , from here on the balance is in the mode for density determination of liquids.




## Enter sinker volume



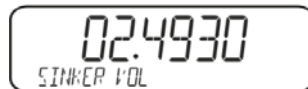
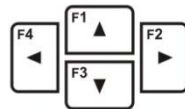
⇒ Press 



⇒ Press , the current set volume is displayed.



⇒ The first digit is flashing and can be changed.  
Using the navigation keys, enter the sinker volume (see chap. 6) and confirm by



⇒ The balance changes into the mode for density determination of liquids.



## 6.5.2 Determining density of the test liquid

⇒ Fill test liquid into the glass beaker.

Make sure that the balance is in the mode for density determination of liquids (see chap. 6.3.1).




If necessary, set balance to zero.

⇒ Place sinker into the upper sample dish, see fig. 5, chap. 6.1.2.



The weight of the sinker in air will be displayed.

⇒ Wait for stability display (▬▬), then press .

⇒ Place sinker into the lower sifting bowl, see fig.6, chap. 6.1.2..

For this remove the immersion basket out from the frame. Always ensure that, when re-immersing into the liquid, no additional bubbles adhere; it is better to use pincers or alike to place the sample directly on the sifting bowl.



⇒ Wait for stability display (▬▬), then press .

The weighing balance will first determine then display the fluid's density.



⇒ When connecting an optional printer, the result will be printed out.

### Printout example KERN YKB-01N:

```
.....  
-----Liquid Dens-----  
Date                03.01.2014  
Time                10:45:10  
Balance ID         132035  
User  
Sinker vol.        2.4930 cm3  
In Air              19.9143 g  
In Liquid           17.4308 g  
Density             0.996189 g/cm3  
-----  
Signature  
.....
```



To avoid corrosion, don't leave the density set immersed in liquid for a long time.

## 6.6 Series KERN ALS-A

⇒ In weighing mode press **MENU** button. The first menu item „count“ is displayed.

A rectangular digital display showing the word "Count" in a large, black, monospaced font.

⇒ Press **MENU** button

A rectangular digital display showing "dEn5" in a large, black, monospaced font.

⇒ Acknowledge using **PRINT** button, the current setting is displayed.

⇒ Using **MENU** button select „d Liquid“

A rectangular digital display showing "dL 190 ld" in a large, black, monospaced font.

⇒ Confirm using the **PRINT** button, the currently set density of the sinker is displayed (factory setting 3.0000 g/cm<sup>3</sup>).

A rectangular digital display showing "d5 3.0000" in a large, black, monospaced font.

⇒ For any change, enter the density of the sinker as follows.  
To delete keep pressed the **TARE** button. Use the navigation buttons  $\uparrow$  to increase/reduce the digit. Use the **TARE** button to select the next digit. Repeat this sequence for each digit.

A rectangular digital display showing "d5 8.0633" in a large, black, monospaced font.

⇒ Confirm input by pressing the **PRINT** button. The display for weight determination of the "Sinker in air" appears.

A rectangular digital display showing "UE , Air" in a large, black, monospaced font.

- ⇒ Confirm by pressing the **PRINT** button.  
If weighing balance does not show Zero, press **TARE**.
- ⇒ Place sinker into the upper sample dish, see fig. 5, chap. 6.1.2.
- ⇒ Wait for stability display [**\***], take over the weight value „sinker in air“ using the **PRINT** button.
- ⇒ Wait until the display for weight determination of „sinker in test liquid“ appears.

A rectangular digital display showing "UE , LIQ" in a large, black, monospaced font.

- ⇒ Confirm by pressing the **PRINT** button.
- ⇒ Place sinker into the lower sifting bowl, see fig.6, chap. 6.1.2..  
For this remove the immersion basket out from the frame. Always ensure that,

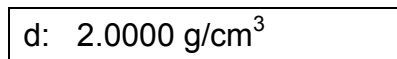
when re-immersing into the liquid, no additional bubbles adhere; it is better to use pincers or alike to place the sample directly on the sifting bowl.

- ⇒ Wait for stability display [**\***], take over the weight value „sinker in test liquid“ using the **PRINT** button. The weighing balance will first determine then display the fluid's density.



- ⇒ When an optional printer is connected, the displayed value can be edited using the **PRINT** button.

Printout example (KERN YKB-01N):



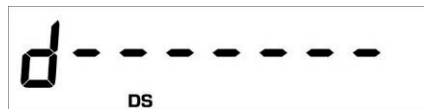
### Return to weighing mode

- ⇒ Press the **ON/OFF** key



- ⇒ or use the **MENU** button to start a new measuring cycle.

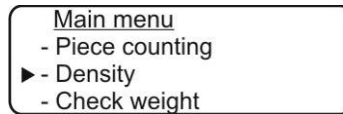
If at the density determination errors have appeared, „d-----“, is displayed.



To avoid corrosion, don't leave the density set immersed in liquid for a long time.

## 6.7 Series KERN ALT\_B

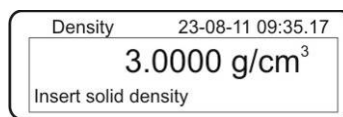
- ⇒ In weighing mode press **MENU** button. The master menu will be displayed.
- ⇒ Use the navigation buttons  $\uparrow$  to select the menu item „Density“.



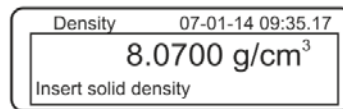
- ⇒ Acknowledge using **PRINT** button, the current setting is displayed.
- ⇒ Use the navigation buttons  $\uparrow$  to select the setting „Liquid“.



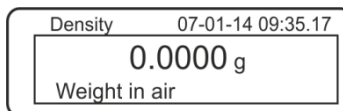
- ⇒ Confirm using the **PRINT** button, the currently set density of the sinker is displayed (factory setting 3.0000 g/cm<sup>3</sup>).



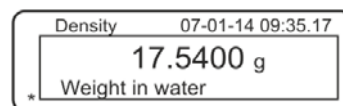
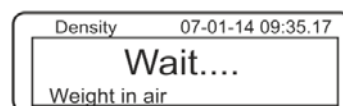
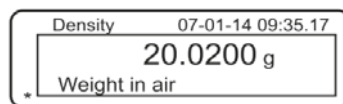
- ⇒ For any change press the **TARE** key.  
Use the navigation buttons  $\uparrow$  to increase/reduce the digit. Use the **TARE** button to select the next digit. Repeat this sequence for each digit. To delete keep pressed the **TARE** button.



- ⇒ Confirm entry with **PRINT** button, the display for calculation of „Weight in air“ is displayed.  
Should the balance not show Zero, press the **TARE** button.

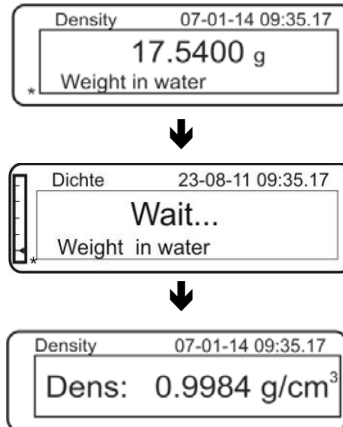


- ⇒ Place sinker in the upper sample dish, see fig. 5, chap. 6.1.2.
- ⇒ Wait for stability display [**\***], then take over the weight value using the **PRINT** button.



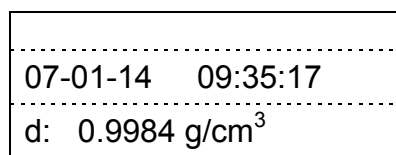


- ⇒ Wait until the display for weight determination of „sinker in test liquid“ appears.
- ⇒ If possible, immerse the sinker bubble-free in the test liquid.  
Make sure that the sinker is at least 1 cm immersed (see fig. 6, chap. 6.1.2).
- ⇒ Wait for stability display [**\***], take over the weight value using **PRINT** button. The density of the test liquid is displayed.

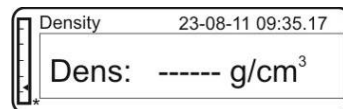


- ⇒ When an optional printer is connected, the displayed value can be edited using the **PRINT** button.

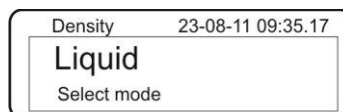
Printout example (KERN YKB-01N):



If at the density determination errors have appeared, „d-----“, is displayed.



- ⇒ For further measurements go back to density determination mode, press **MENU** button.



- ⇒ Back to weighing mode, press **ON/OFF** button.



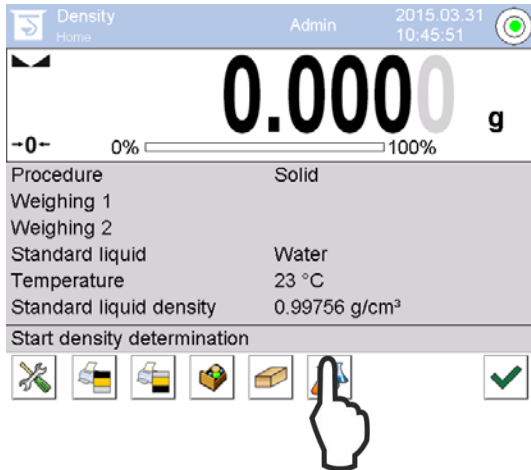
To avoid corrosion, don't leave the density set immersed in liquid for a long time.

## 6.8 Series KERN AET



Selecting density application see chap. 5.6

### 6.8.1 Call up density determination mode of liquids and enter sinker volume



⇒ To select method "liquid" press the

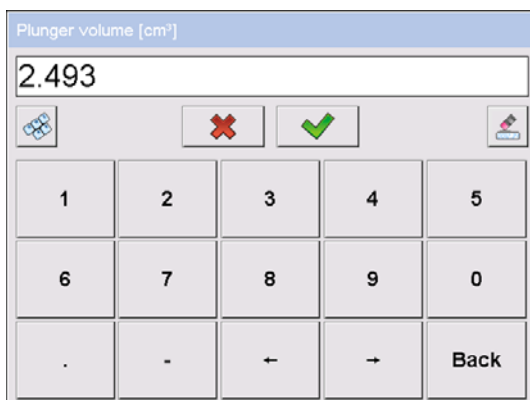
function key



⇒ You will see the display used to enter the sinker volume.



### Sinker volume



⇒ Tap < **Volume of plunger** >.

Enter volume for sinker and confirm by



Press the function key to start density determination.

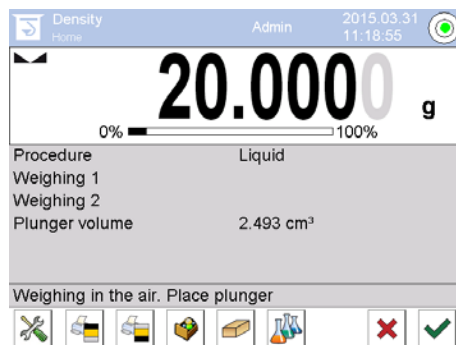
## 6.8.2 Determining density of the test liquid

1. Fill test liquid into the glass beaker.
2. Put the sinker into the upper sample dish.

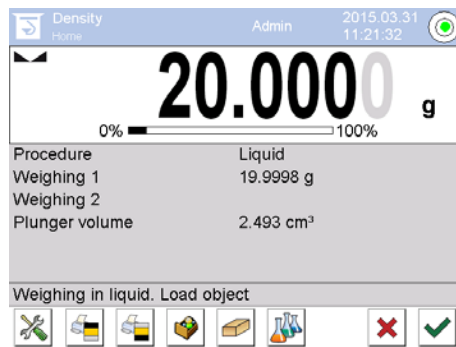


Fig.1: "Weighing in air"

The weight of the sinker in air will be displayed.




3. Wait for stability display and confirm by ✓. The weighing value for “Weighing in air” will be displayed under <weighing process 1>.

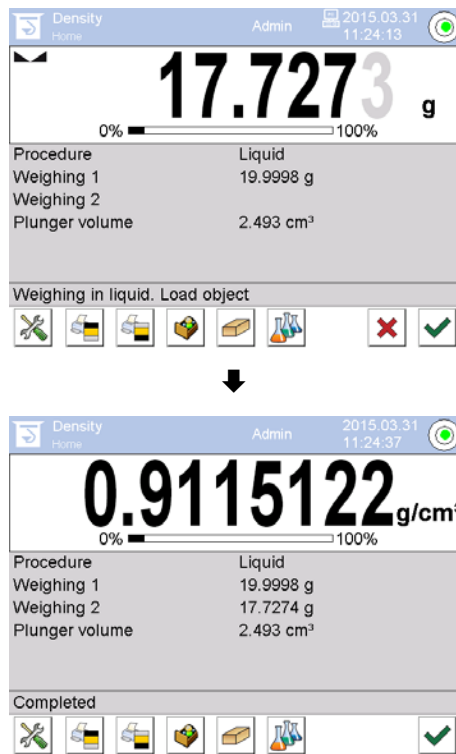



4. Put the sinker into the lower sifting bowl.



Fig. 2: “Weighing in test liquid”

- Wait for stability display and confirm by . The weighing balance will first determine then display the fluid's density.



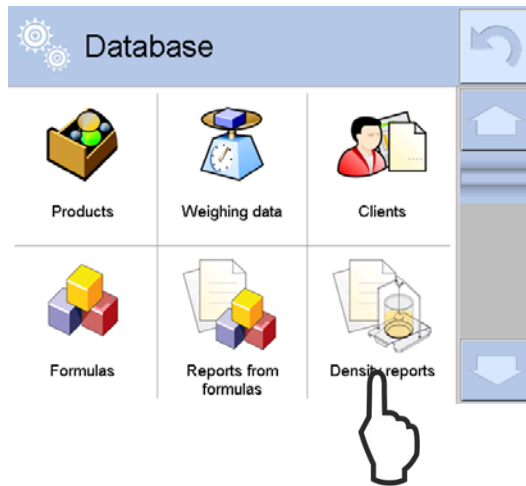
- When connecting an optional printer, the result will be printed out. Printout example see chap. 6.6.39.
- Finish process by . Remove the sample. Start more measurements at step 1.

### 6.8.3 Log density determination

Printout example default report (KERN YKB-01N):

----- Density -----	
----- Liquid -----	
Operator	Admin
Balance ID	132012
Date	2015.03.05
Time	11:12:30
Plunger volume	2.493 g/cm <sup>3</sup>
Weighing 1	20.001 g
Weighing 2	17.000 g
Density	1.203771 g/cm <sup>3</sup>
-----	
Signature	
.....	

If a measurement report is printed, the data record will automatically be saved to the database under **<Density reports>**.



	Timestamp	Density (g/cm³)
1	2015.03.31 11:08:14	12.92708
2	2015.03.31 11:11:35	12.92969
3	2015.03.31 11:12:18	6.469482
4	2015.03.31 11:13:41	6.574415

To **<Open/Print>** press and hold your finger on the desired data record until the context menu appears.

Open  
Print  
Cancel

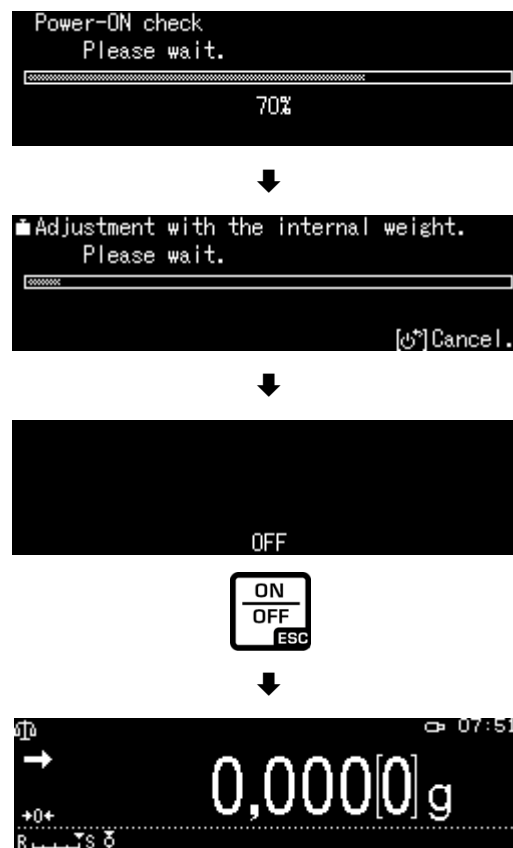


Field	Value
00285 Sample number	
1 Start date	2015.03.31 11:13:41
2 End date	2015.03.31 11:14:55
3 Density	6.574415 g/cm³
4 Volume	0.71927 cm³
5 Procedure	Solid

## 6.9 KERN ABP Series

### 6.9.1 Installing the density determination set

- ⇒ Insert frame in the weighing compartment. The round opening above at the frame has to point into the direction where the immersion basket is inserted from.
- ⇒ Put the supporting platform of the glass beaker through the frame on the weighing compartment floor. Place it in a way that it does not touch the frame.
- ⇒ Place compensation weights [Nr. 1] on the frame, see allocation list chap.4.1
- ⇒ Close the glass doors. Connect the balance to the power supply and switch on. When the log-in function is enabled, use the navigation keys to select the respective user and enter password.



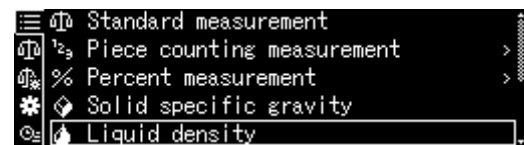
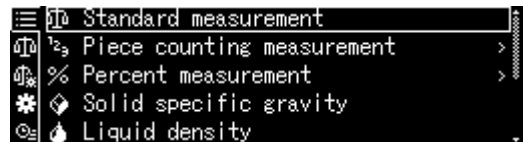
- ⇒ Bring liquid and instruments to the right temperature until you achieve a constant temperature. Observe the warm-up time of the balance.

## 6.9.2 Parameter setting

### 1. Choice of the application

⇒ Using navigation buttons  $\uparrow$   $\downarrow$ , select <Liquid density>. The selected option is indicated by a frame. Press OK to confirm.

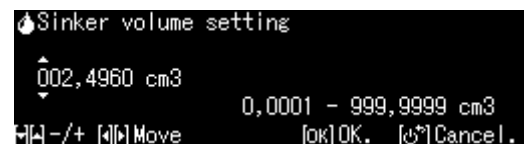
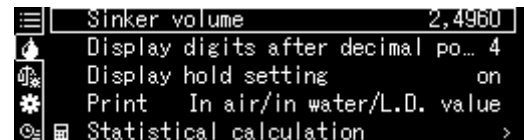
⇒ Press MENU button to display the configuration menu.



### 2. Entering the sinker volume

⇒ Using navigation buttons  $\uparrow$   $\downarrow$ , select <Sinker volume> and press OK to confirm.

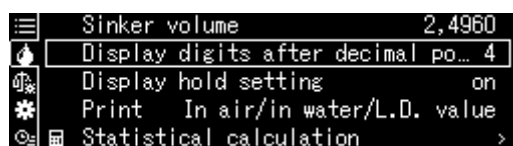
⇒ Using navigation buttons, enter the sinker volume (see chapter 6.1) and press OK to confirm.



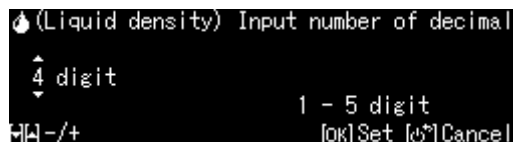


### 3. Number of decimal places

⇒ Using navigation buttons  $\uparrow$   $\downarrow$ , select <Display digits after decimal po..> and press OK to confirm.

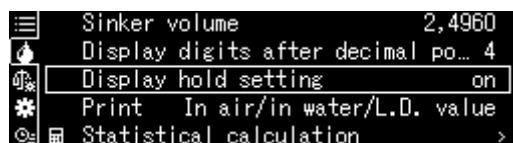


⇒ Using navigation buttons  $\uparrow$   $\downarrow$ , select the number of decimal places and press OK to confirm.

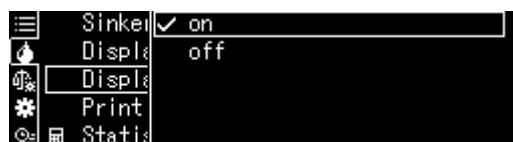


### 4. "Hold" function

⇒ Using navigation buttons  $\uparrow$   $\downarrow$ , select <Display hold setting> and press OK to confirm.

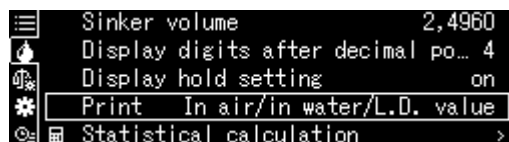


⇒ Using navigation buttons  $\uparrow$   $\downarrow$ , select the option ON or OFF and press OK to confirm.  
With the activated function, the first displayed result value will be displayed on the screen until it is reset using OK button.

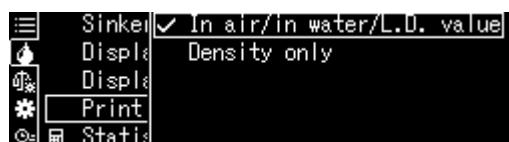


## 5. Data transmission

⇒ Using navigation buttons  $\uparrow$   $\downarrow$ , select  $\langle$ Print $\rangle$  and press OK to confirm.



⇒ Apply the selected setting, pressing OK.



**Protocol template  
<In air/in water/L.D. value>**

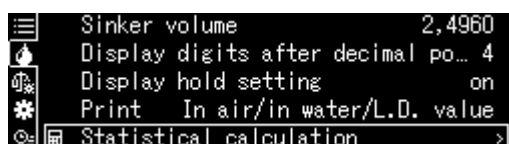
LIQUID DENSITY	
DATE	2018 Nov. 14
TIME	10.20.24
AIR=	20.0010 g
WATER=	17.4624 g
DL=	1.0183 g/cm <sup>3</sup>

**Protocol template  
<Density only>**

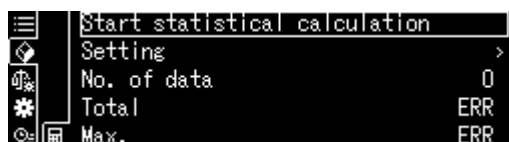
LIQUID DENSITY	
DATE	2018 Nov. 14
TIME	10.20.24
DL =	1.0183 g/cm <sup>3</sup>

## 6. Statistics

⇒ Using navigation buttons  $\uparrow$   $\downarrow$ , select  $\langle$ Statistical calculation $\rangle$  and press OK to confirm.



⇒ The consecutive steps should be performed according to the balance operating manual, see chapter "Statistics".



⇒ Press **ON/OFF** to return to the density determination mode.



**i** To switch between the "Density determination mode"  $\leftrightarrow$  and the "Weighing mode", press **F**.

### 6.9.3 Determination of the examined liquid density

1. Fill the beaker with the examined liquid. Attach the dipper basket. It should not touch the beaker. Press **TARE** to reset the balance.
2. Ensure the balance is in the **<[Icon] Liquid density>** mode (see chapter 6.8.2).



Reset the balance as required.

3. Place the sinker on the upper sample pan.



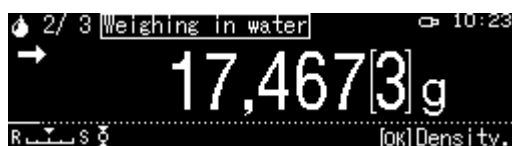
The sinker weight in the air will be displayed.

4. Wait until the stabilisation indicator is displayed (➔), then press OK to take over the weighed value.
5. Place the sinker on the lower strainer pan.  
To do it, remove the dipper basket from the stand. When submerging in the liquid again, no extra air bubbles should be created. It is best to apply the sample using tweezers or place it directly on the strainer pan.



Fig. 2: Weighing in the examined liquid

6. The sinker weight in the examined liquid will be displayed.



7. Wait until the stabilisation indicator is displayed, then press OK to take over the weighed value.

The liquid density will be determined by the balance taking into account aerodynamic displacement, and then displayed..



8. The result can be printed after an optional printer has been connected.
9. Remove the sample. To perform consecutive measurements, press **OK** and start the procedure from step 1.



To prevent corrosion-related damage to the dipper basket, do not leave it submerged in the liquid for an extended period of time.

## 7 Preconditions for Precise Measurements

There are numerous error possibilities during density determination. Accurate knowledge and caution are required to achieve precise results when applying this density set in combination with the balance.

### 7.1 Calculation of Results

The balance displays results for density determination by giving four or five decimal places. However, this does not mean that the results are accurate down to the last decimal place as this would be the case for a calculated value. Therefore all weighing results used for calculations have to be examined closely.

### 7.2 Influence Factors for Measurement Errors

#### 7.2.1 Air bubbles

A small bubble with a diameter of 1 mm results in a buoyancy of 0.5 mg, while those with 2 mm  $\varnothing$  already produces a buoyancy of 4 mg.

Therefore, make sure that no air bubbles adhere on the solid object or sinker that is immersed in the liquid.

An oily surface causes air bubbles when immersing in the liquid, so

- degrease the solvent-resistant solid sample
- clean all parts that are immersed regularly and don't touch them with bare fingers

Don't lay solid samples (particularly flat objects) outside of the liquid on the sample dish, because this results in air bubbles by the joint immersion.

#### 7.2.2 Solid body sample

A sample possessing too great a volume that is immersed in liquid will result in an increase in liquid level inside the glass pitcher. As a result, part of the suspension bracket of the sifting bowl will also be immersed causing buoyancy to increase.

As a consequence the weight of the specimen in the liquid will drop.

Samples that change the volume or assimilate liquid are unsuitable for measurement.

### 7.2.3 Liquids

Solids are generally not sensitive to temperature changes, so that the corresponding density changes are not relevant. However, since you work with an aid liquid by the density determination of solids, according to the "Archimedean Principle", its temperature is taken into account. The temperature change effects liquids greater and causes changes in the density in order of 0.1 to 1 ‰ per °C. Hereby, the third digit after the decimal point is affected.

### 7.2.4 Surface

The suspension bracket of the sample dish penetrates the surface of the liquid. This state undergoes continuous change. If the sample or the sinker is relatively small, the surface tension will impair repeatability. The addition of a small amount of detergent makes the surface tension negligible and increases repeatability.

### 7.2.5 Sinker for density determination of liquids

To save test fluids by the density determination of liquids, a small glass beaker and an appropriate sinker is to be used. Hereto, it should be noted that a larger sinker achieves greater accuracy.

Determine the buoyancy and volume of the sinker as accurately as possible. For the determination of fluid density these results are applied to the common denominator as well as the numerator of the formula.

## 7.3 General information

### 7.3.1 Density / Relative Density

Relative density follows from the weight of a specimen divided by the weight of water (at 4° Celsius) of the same volume. For this reason relative density does not have a unit. Density equals mass divided by volume.

The application of the relative density instead of the density of a liquid in a formula produces an incorrect result. In the case of liquids only their density is physically meaningful.

### 7.3.2 Drift of Balance Display

The drifting of a balance does not influence the final result of the density determination although the shown weight of weighing in air is affected. Accurate values are merely required if the density of liquids is determined by means of a sinker.

When changing the ambient temperature or location, an adjustment of the balance is necessary. For this purpose, remove the density set and carry out adjustment using the standard weighing pan.

## 8 Density Table for Liquids

Temperature [°C]	Density $\rho$ [g/cm <sup>3</sup> ]		
	Water	Ethanol	Methanol
10	0.9997	0.7978	0.8009
11	0.9996	0.7969	0.8000
12	0.9995	0.7961	0.7991
13	0.9994	0.7953	0.7982
14	0.9993	0.7944	0.7972
15	0.9991	0.7935	0.7963
16	0.9990	0.7927	0.7954
17	0.9988	0.7918	0.7945
18	0.9986	0.7909	0.7935
19	0.9984	0.7901	0.7926
20	0.9982	0.7893	0.7917
21	0.9980	0.7884	0.7907
22	0.9978	0.7876	0.7898
23	0.9976	0.7867	0.7880
24	0.9973	0.7859	0.7870
25	0.9971	0.7851	0.7870
26	0.9968	0.7842	0.7861
27	0.9965	0.7833	0.7852
28	0.9963	0.7824	0.7842
29	0.9960	0.7816	0.7833
30	0.9957	0.7808	0.7824
31	0.9954	0.7800	0.7814
32	0.9951	0.7791	0.7805
33	0.9947	0.7783	0.7796
34	0.9944	0.7774	0.7786
35	0.9941	0.7766	0.7777

## 9 User Instructions

- To form a reproducible mean value several density measurement are necessary
- Remove fat from solvent-resistant sample / sinker / glass beaker.
- Regularly clean sample dishes/ sinker/glass beaker, do not touch immersed part with your hands
- Dry sample/ sinker/pincers after each measurement.
- Adjust sample size to sample dish (ideal sample size > 5 g).
- Only use distilled water.
- When immersing for the first time, lightly shake sample dishes and sinker, in order to dissolve air bubbles.
- Always ensure that, when re-immersing into the liquid no additional bubbles adhere; it is better to use pincers to place the sample.
- Remove firmly adherent air bubbles with a fine brush or a similar tool.
- To avoid adherent air bubbles smoothen samples with rough surface.
- Take care that no water drips onto the upper sample dish when weighing with the help of pincers.
- In order to reduce the surface tension of water and the friction of the liquid on the wire, add three drops of a common detergent (washing-up liquid) to the aid liquid (density modification of dist. water occurring due to the addition of tensides can be ignored).
- Oval samples can be held more easily with pincers when you cut grooves into them.
- The density of porous solids may only be determined approximately. Buoyancy errors occur when not all the air is eliminated from the pores during immersion in the aid fluid.
- To avoid great vibrations of the balance, place sample carefully.
- Avoid static charge, e. g. dry sinker with cotton cloth only.
- If the density of your solid only deviates slightly from that of distilled water, ethanol may be used as aid liquid. However, check beforehand whether the sample is solvent-proof. In addition you must observe the applicable safety regulations when working with ethanol.
- To avoid corrosion, don't leave the density set immersed in liquid for a long time.