



Installation and operating instructions

Steca PF166-H and PF240-H refrigerator / freezer
for 12 / 24 V DC



Contents

1	About this manual	3
1.1	Applicability	3
1.2	Users	3
1.3	Description of symbols	3
2	Safety	4
2.1	Dangers during installation and commissioning	4
2.2	Exclusion of liability	4
3	Disposal instructions	5
4	Device and features overview	5
5	Installation	6
6	Connection	6
6.1	Direct connection to the battery	7
6.2	Connection to a charge controller with deep discharge protection	7
7	Operating the device	7
7.1	Switching the device on / off	7
7.2	Setting the temperature	7
7.3	Temperature alarm	8
8	Menu functions	8
8.1	Setting the brightness	8
8.2	Setting the display of Celsius / Fahrenheit	8
8.3	Setting refrigerator / freezer mode	8
9	Power outage display	9
10	Notes on freezing and storage	9
11	Features	10
11.1	Interior lighting	10
11.2	Baskets	10
11.3	Lock	10
11.4	Freezer tray (depending on features)	11
11.5	Cold-storage accumulators (depending on options)	11
12	StopFrost system	11
13	Defrosting	12
13.1	Freezer function	12
13.2	Refrigerator function	12
14	Cleaning	12
15	Faults	13
16	Decommissioning	13
17	Technical data	14
17.1	Electrical data	14
17.2	Device data	14
18	Warranty terms	14

1 About this manual

1.1 Applicability

This manual describes the installation, commissioning, function, operation, maintenance and deinstallation of the refrigerator / freezer.

When installing the remaining components, e.g. the photovoltaic modules, the cabling, and other accessories, be sure to observe the appropriate installation instructions provided by each manufacturer.

1.2 Users

Installation, commissioning, maintenance and deinstallation of the refrigerator / freezer may only be done by trained personnel in accordance with the applicable on-site installation regulations. The professional personnel must be familiar with this operating manual and follow the instructions contained herein.

1.3 Description of symbols



1.3.1 The structure of the warning notices

SIGNAL WORD

Type, source and consequences of the danger!

- Measures for avoiding danger

1.3.2 Danger levels in warning notices

Danger level	Probability of occurrence	Consequences resulting from non-compliance
 DANGER	imminent threat of danger	death, serious bodily injury
 WARNING	possible threat of danger	death, serious bodily injury
 CAUTION	possible threat of danger	minor bodily injury
CAUTION	possible threat of danger	property damage

1.3.3 Notes

NOTE

Note on easier and safer working habits.

- Measures for easier and safer working habits

1.3.4 Other symbols and markings

Symbol	Meaning
►	call to action
▷	result of action
–	action description
•	list
Emphasis on issue at hand	emphasis on issue at hand

2 Safety

2.1 Dangers during installation and commissioning

The following dangers exist during installation / commissioning of the refrigerator / freezer and during operation (in case of installation errors):

- To avoid personal and material damage, the device should be unpacked and installed by two people.
- If the device is damaged, contact the supplier immediately – before connection.
- To ensure safe operation, only install and connect the device according to the information in the operating instructions.
- If a fault occurs, immediately remove power from the device. Remove the fuse and disconnect the battery or pull the power plug.
- Only allow trained personnel to perform repairs and other internal work on the device, otherwise this may result in significant danger for the users.
- Do not bring open flames or other ignition sources into the internal spaces of the device. Ensure that the cooling circuit is not damaged when transporting and cleaning the device. In case of damage, keep ignition sources away and ventilate the room well.
- This device is not intended for persons (or children) with physical, sensory, or mental disabilities, or who have inadequate experience and knowledge, unless they are instructed in the use of the device, or initially supervised, by a person responsible for their safety. Children should not be left alone with the device, to ensure that they do not play with it.
- Avoid long-term skin contact with cold surfaces or cooled / frozen products. This can lead to pain, numbness and freezing. Wear protective clothing, e.g. gloves, when longer skin contact is unavoidable.
- Do not immediately consume ice cream, especially frozen drinks and ice cubes, after removal or while they are still too cold. The low temperatures can present a "burn danger".
- Do not consume food that has been stored for too long, it can lead to food poisoning.
- The device is intended for cooling and freezing food and for the preparation of ice products. It is conceived for household use. The applicable commercial regulations must be observed when the device is used in a commercial environment.
- The appliance is designed for use in enclosed areas. Do not operate the appliance outdoors or in areas where it is exposed to splash water or damp conditions.
- For lockable devices, do not store the key near to the device or within the reach of children.
- Do not store explosive substances or spray cans with inflammable materials, such as propane, butane, pentane etc., in the device. Escaping gases can be ignited by electrical components. These types of spray can be recognized by the contents printed on the can or by a flame symbol.
- Do not use electrical equipment within the device.
- The appliance is not suitable for operation in potentially explosive atmospheres.

2.2 Exclusion of liability

The manufacturer cannot monitor the compliance to this manual as well as the conditions and methods during the installation, operation, usage and maintenance of the refrigerator / freezer. Improper installation of the system may result in damage to property and, as a result, in bodily injury.

Therefore, we assume no responsibility and liability for loss, damage or costs which result or are in any way related to incorrect installation, improper operation and incorrect use and maintenance.

Similarly, we assume no responsibility for patent right or other right infringements of third parties caused by usage of this refrigerator / freezer.

The manufacturer reserves the right to make changes to the product, technical data or assembly and operating instructions without prior notice.

- ▶ As soon as it becomes evident that safe operation is no longer possible (e.g. if there is visible damage), remove the device from the power supply immediately.

3 Disposal instructions

The packaging is made from recyclable materials.

- Corrugated cardboard / Cardboard
- Moulded polystyrene parts
- Polyethylene plastic
- Polypropylene reinforcing straps

WARNING

Packaging material is not a toy for children – danger of suffocation from plastic!

- ▶ Bring the packaging to an official recycling centre.

The worn out device:

The device still contains valuable materials and is not to be disposed of in the normal household waste.

- Render worn out devices unusable. Pull the power plug, cut the power cable and make the lock unusable to prevent children from locking themselves inside.
- Ensure that the cooling circuit of the worn out device is not damaged when being transported to prevent uncontrolled escape of the refrigerant it contains (data on type plate) and oil.
- Information on the coolant used is on the type plate.
- Worn out devices must be professionally disposed of in accordance with local regulations and legislation.

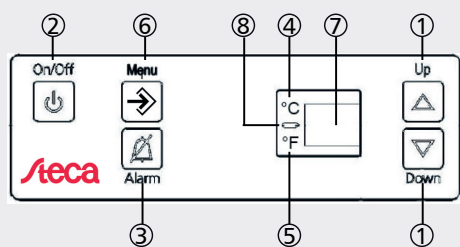
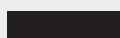

4 Device and features overview

- ① Temperature adjustment button (Up / Down)
- ② On / Off button
- ③ Alarm-off button (Alarm)
- ④ Temperature display °C
- ⑤ Temperature display °F
- ⑥ Menu button for configuration (Menu)
- ⑦ Digital temperature display
- ⑧ Minus display

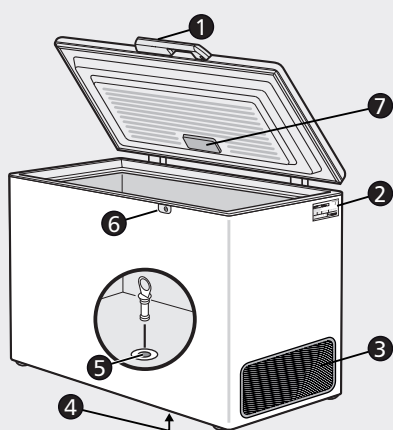

- ① Operating and monitoring element
- ② Type plate
- ③ Motor space ventilation grill
- ④ Condensation water outflow (external)
- ⑤ Condensation water outflow (internal) and plug
- ⑥ Lock
- ⑦ Interior lighting

NOTE

Be sure to close the condensation-water outflow opening in the base of the device!

- ▶ Be sure to close the condensation-water outflow opening in the base of the device using the plug provided before commissioning the device! This is important for proper functioning of the device.



5 Installation

- Avoid installation locations in direct sunlight, or next to stoves, heating, or similar heat sources.
- The floor at the installation location should be level and flat. Install the device a sufficient distance from the wall so that the lid can open and close unhindered.
- Do not cover the ❶ gap between the lower edge of the cabinet and the floor, because the chiller must be provided with cooling air.
- The minimum clearance between the ventilation grill and the wall is 20 cm ❷. This clearance must always be maintained and the ventilation grill must not be covered.
- Do not obstruct the outer cladding of the device. A minimum all-round clearance of ❸ 20 mm must be maintained to ensure adequate heat dissipation.
- According to the EN 378 standard, the installation room for the device must have a volume of 1 m³ per 8 g of R 290 coolant, so that if a leak develops in the cooling circuit no inflammable gas-air mixture can result in the installation room. Information on the coolant volume can be found on the type plate.
- Do not connect the device together with other devices using an extension cable – danger of overheating.
- Take note of the cable cross-section information in the table below when extending the power cable.

Cable sizes		12 V Cable length		24 V Cable length	
Cross-section	AWG	m	ft.	m	ft.
2.5	12	2.5	8	5	16
4	12	4	13	8	26
6	10	6	19.5	12	39

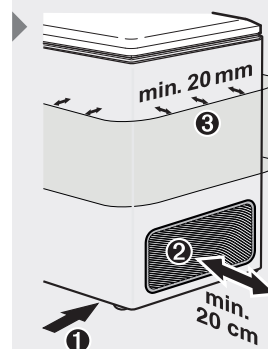

6 Connection

The power type and voltage at the installation location must match the specifications on the type plate. The type plate is located on the upper right side wall of the cabinet.

⚠ WARNING

Risk of electrical shock and fire when connected to a voltage supply outside the specified range.

- ▶ The cable provided must be connected to a 12 V or 24 V DC connection at the battery or the charge controller.
- ▶ Please pay attention to the correct polarity: blue (–) and red (+).

ⓘ NOTES

Energy saving

- ▶ Avoid long and unnecessary opening of the lid.
- ▶ Allow warm food to first cool to room temperature before storing it in the device.
- ▶ Defrost the device when an ice layer has formed. This improves the cooling transfer and reduces the energy consumption.

Operation as refrigerator

- ▶ If the device is used as a refrigerator (inside temperature above 0 °C / 32 °F), humidity will condense on the interior container. Drain condensed water periodically (see chapter 13 Defrosting). Do not store moisture-sensitive goods directly on the bottom of the refrigerator but in a basket or with distance to the bottom.



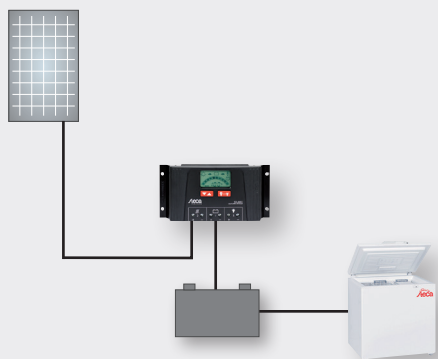

6.1 Direct connection to the battery

⚠ CAUTION

The device does not function

- ▶ Please pay attention to the correct polarity!

The compressor is switched off by the integrated deep discharge protection, but the control unit remains in operation. The alarm sounds when the temperature increases (see chapter 7.3).

ⓘ NOTE

Connection to the battery

- ▶ Select this type of connection when you wish to give your device a high priority in the solar energy system, e.g. when you wish to cool / freeze critical products.

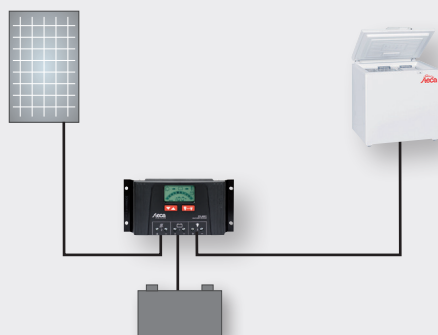

6.2 Connection to a charge controller with deep discharge protection

⚠ CAUTION

The device does not function

- ▶ Please pay attention to the correct polarity!

If the deep discharge protection of the charge controller completely switches off the cabinet power, then the control unit also receives no power. When the device is switched on again automatically, the integrated power outage display (see chapter 9) informs you of the internal temperature reached.

ⓘ NOTE

Connection to a charge controller

- ▶ Select this type of connection when you wish to give your device the same priority as other loads in the solar energy system, e.g. when you wish to cool / freeze non-critical products.

7 Operating the device

7.1 Switching the device on / off

The device can be manually switched on or off using the ② button (On / Off).

If the cabinet is switched off, the ⑧ minus symbol flashes to indicate that the cabinet is still connected to the power.

When the device is connected for the first time, it must be manually switched on by pressing the ② button (On / Off).

On delivery, the device is set to cool (+8 °C | 46 °F).

7.2 Setting the temperature

The standard internal temperature for normal operation is +8 °C | 46 °F. This value can be changed in the following manner.

- The desired internal temperature is set by pressing the ① buttons (Up / Down). Pressing a button once causes the display to begin flashing. If the ① button is pressed again while the display is flashing, each button press increases / reduces the value by 1 °C | 1 °F.
- If no button is pressed within a period of 5 seconds, the currently set value is adopted as the actual temperature.

ⓘ NOTE

Adjustable temperature range

- ▶ In refrigerator mode, temperatures from +2 °C | 36 °F to +12 °C | 54 °F can be set, and in freezer mode, temperatures from -10 °C | 14 °F to -20 °C | -4 °F can be set.

7.3 Temperature alarm

The temperature alarm helps to protect your cooled / frozen products and also helps to save energy.

The alarm sounds when the internal space is not cold enough. The temperature display flashes at the same time, or when too much warm air enters the cabinet while sorting, placing, or removing food.





Pressing the alarm-off button mutes the alarm. The temperature display continues to flash until the alarm state is over.

8 Menu functions

The following functions can be set using the menu:

- The display brightness
- Temperature display in degrees Celsius or Fahrenheit
- The use of the device as a refrigerator or freezer

8.1 Setting the brightness

- ▶ Pressing the  button (Menu) for 3 seconds brings you to the menu, the  display (°F symbol) flashes and "b" is displayed.
- ▶ Pressing the  button (Menu) again causes a "1" to appear in the display.
- ▶ The  buttons (Up / Down) allow a brightness value of "1", "2" or "3" to be selected. The higher the number, the brighter the display.
- ▶ Once the desired brightness has been set, this has to be confirmed by pressing the  button (Menu).







Pressing the  button (On / Off) returns you to the standard mode.

NOTE

Energy saving







- ▶ The higher the brightness, the higher the power consumption. The factory setting "b1" is the power-saving mode.

8.2 Setting the display of Celsius / Fahrenheit

- ▶ Pressing the  button (Menu) for 3 seconds brings you to the menu, the  display (°F symbol) flashes and "b" is displayed.
- ▶ Pressing the  button (Up) allows you to change from "b" to "□".
- ▶ If you now press the  button (Menu) then "°C" appears.
- ▶ The  buttons (Up / Down) can now be used to select between "°C" and "°F".
- ▶ Once the desired value has been set, this is confirmed by pressing the  button (Menu).

Pressing the  button (On / Off) returns you to the standard mode.

8.3 Setting refrigerator / freezer mode

- ▶ Pressing the  button (Menu) for 3 seconds brings you to the menu, display  (°F symbol) flashes.
- ▶ Pressing the  button (Up) causes "□" to appear.
- ▶ Pressing the  button again causes "F" to appear.
- ▶ Pressing the  button (Menu) again causes "F □" to display.
- ▶ The  buttons (Up / Down) can now be used to select between refrigerator "F □" and freezer "F □".
- ▶ Once the desired value has been set, this is confirmed by pressing the  button (Menu).

Pressing the  button (On / Off) returns you to the standard mode.

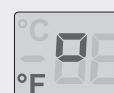

Refrigerator

Freezer



9 Power outage display

If "PS" is shown in the display, this means that: A power interruption in the last hours or days has resulted in a temperature increase within the device. This can occur as a result of (e.g.) deep discharge protection (charge controller).

If you press the alarm-off button while "PS" is displayed, then the display shows the highest temperature reached during the power outage. Depending on the level of warming or thawing, you should check the quality of the food and decide whether it can still be used, even when the cabinet has returned to the set temperature long after the power outage!

This highest temperature is displayed for about one minute. The electronics then display the actual cooling / freezing temperature once more.

10 Notes on freezing and storage

- Store the same types of cooled / frozen products together.
- **The following products are suitable for freezing:** meat, game, poultry, fresh fish, vegetables, fruit, dairy products, bread, cakes and pastries, convenience food.
- **The following products are not suitable for freezing:** Cabbage or lettuce, radishes, grapes, whole apples and pears, fatty meat.
- Always pack food that you freeze yourself in household-sized portions. To ensure that the products quickly freeze to the core, the following quantities per package should not be exceeded: Fruit and vegetables up to 1 kg, meat up to 2.5 kg.
- Blanch vegetables after washing and portioning (place in boiling water for 2 – 3 minutes, then remove and rapidly cool in cold water).
- Do not salt or season fresh food and blanched vegetables before freezing. Other food should only be lightly salt and seasoned. Seasoning changes the taste intensity.
- Commonly available freezer bags and reusable plastic, metal, and aluminium containers can be used for packaging.
- Do not allow unfrozen food to come into contact with already frozen food. Always store dry packages to ensure that they do not freeze together.
- Always label the packaging with date and contents and never exceed the recommended maximum storage time of the frozen products.
- Do not freeze bottles and cans containing carbonated liquids. They may burst.
- Only thaw the quantity that you currently actually require. Prepare thawed food as quickly as possible for consumption.

11 Features

11.1 Interior lighting

The interior lighting switches on automatically when opening the lid and switches off when closing the lid.

LED lamp data:

Wattage: max. 5 W. The voltage shall correspond to the input voltage range of the refrigerator/freezer or be higher than this range. Bulb holder: E14.

Attention: Only use lamps for direct current (DC).

Changing the LED lamp:

Attention: Disconnect the supply line from the battery and/or pull out the upstream fuse.

- Pull cover plate off in the direction of the arrow.
- Change LED lamp.
- Fit the cover plate again.

11.2 Baskets

The baskets make sorting easier. The upper baskets can be hung by the handle on the cabinet frame. The lower baskets stand on the floor of the device or on the inwardly pivoted handles of the lower baskets.

Press the handle down, then lift and pivot inwards. Simply grasp the handle from above to remove the lower baskets.

11.3 Lock

The lock is equipped with a safety mechanism.

Locking the appliance:

- 1 ▶ Press the ① button and keep it depressed.
- 2 ▶ Turn the ② key 90°.

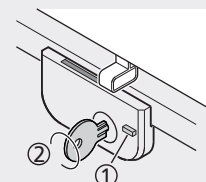
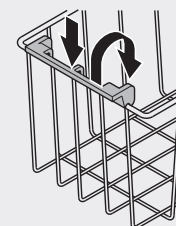
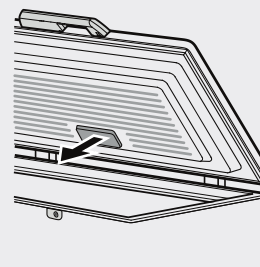

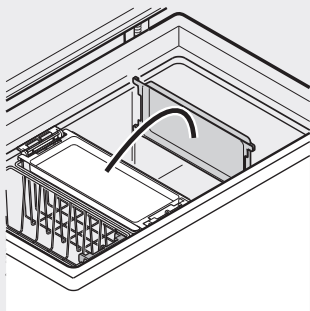

11.4 Freezer tray (depending on features)

The freezer tray can either be suspended on the basket or can be slid into the interior container and used as a partition.

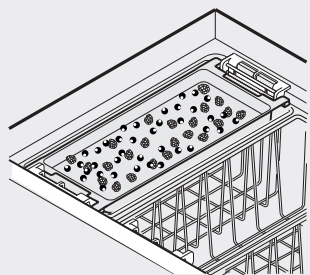

The freezer tray allows you to gently freeze fruit (e.g. berries, fruit pieces), herbs and vegetables for garnishing. Loosely distribute the cooled / frozen products on the freezer tray (the fruit do not stick together and largely retain their original form). Allow to freeze for 10 to 12 hours, then pack into freezer bags or containers and store in a basket.

You can also use the trays as partition walls. This allows you to create two different temperature zones. The freezer trays can also be used to catch condensation water.

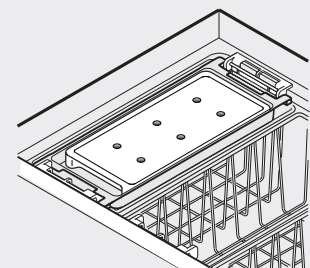

11.5 Cold-storage accumulators (depending on options)

In the event of a power failure, the cold-storage accumulator delays the temperature increase in the freezer compartment.

When switching on for the first time, insert the accumulator in direct contact with the interior container side walls and the interior container floor so that it freezes quickly.

When the accumulator is completely frozen, position it at the top of the interior container. To do this, place the freezer tray containing the accumulator in one of the top baskets. If the freezer tray continues to be needed as a partition, place the accumulator in the basket directly on top of the frozen goods.

12 StopFrost system

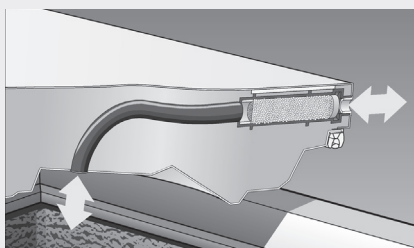

The device has a new StopFrost system. This system significantly reduces the build up of frost, ice and condensation water so that defrosting is seldom necessary.

The lid can also be immediately reopened after filling the device with cooled / frozen products, since the StopFrost system provides immediate pressure compensation once the lid is closed.

Function: A connection is made between the internal and external environments via a dry cartridge foamed into the device lid.

In normal devices, moist air is sucked in via the lid seals during the cooling phase, which leads to the formation of frost and ice over time.

This moisture is taken in by the StopFrost system so that only dry air remains in the inner compartment. During pauses in the cooling process, the dry air flows outside once more, thus drying the dry cartridge.

13 Defrosting

13.1 Freezer function

Over longer operating periods, a layer of frost and / or ice forms on the inner walls. This increases the energy consumption. Regular defrosting should be done for this reason.

- Switch off the device for defrosting. Remove the fuse and disconnect the battery or pull the power plug.
- Wrap the cooled / frozen goods in paper or blankets and store them in the baskets in a cool place.
- Remove the partition wall or freezer tray and place it underneath the device so that the condensation water flows through the outflow opening and into the partition wall or freezer tray. Pull the condensation water plug from the outflow opening.
- Leave the cabinet lid open during the defrosting process. Mop up any remaining condensation water with a cloth and clean the device.

CAUTION: Never use a mechanical device or any other artificial aid for defrosting, other than those recommended by the manufacturer.

13.2 Refrigerator function

Depending on the humidity, water will condense on the interior container. The condensed water must be drained periodically.

- Remove the partition wall or freezer tray and place it underneath the device so that the condensation water flows through the outflow opening and into the partition wall or freezer tray. Pull the condensation water plug from the outflow opening.
- Mop up any remaining condensation water with a cloth and clean the device.

i NOTE

- ▶ Do not leave the condensation water plug removed permanently. Otherwise humidity will flow into the device and will condense inside.

14 Cleaning

Always switch the device off before cleaning. Remove the fuse and disconnect the battery or pull the power plug.

Clean the inner compartment, accessories, and outer walls with warm water and a small amount of detergent. Never use cleaning agents containing sand or acidic chemical solvents.

! CAUTION

Danger of damage and personal injury.

- ▶ Do not use steam cleaning devices!

- Ensure that no cleaning water penetrates into the electrical components or the ventilation grill.
- Thoroughly dry everything with a cloth.
- The inlet and exhaust grills must be regularly cleaned. Dust deposits increase the energy consumption. Ensure that no cables or other components are torn off or damaged.

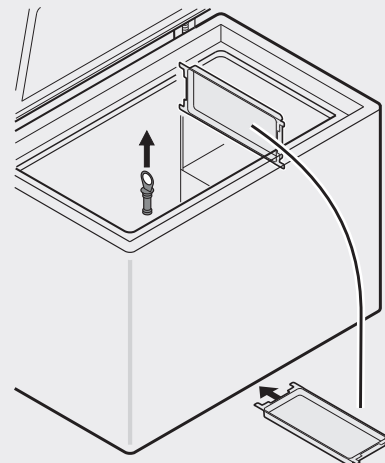

15 Faults

Your device is designed and manufactured for a long, fault-free, operating life. If it seems as if a fault has appeared during operation, please check whether this is perhaps due to an operating error, since you must pay for any costs incurred if the fault was caused by an operating error, even in the warranty period.

You can resolve the following faults yourself by isolating the possible causes:

- ▶ The device does not work, the display is completely switched off, even the minus sign does not flash: Check
 - ▷ *the correct polarity of the power connection*
 - ▷ *the fuse in the power cable of the device*
 - ▷ *the battery cables*
- ▶ The device makes too much noise: Check
 - ▷ *whether the device stands securely on the floor*
 - ▷ *whether neighbouring furniture or objects are being set in vibration by the running coolant compressor. Note that flow noises within the cooling circuit cannot be avoided.*
- ▶ The temperature is not low enough: Check
 - ▷ *the settings in the "Setting the temperature" section*
 - ▷ *whether the correct values have been set*
 - ▷ *whether the battery voltage is perhaps too low*
 - ▷ *whether excessively large quantities of fresh food have been stored; check the display again in 24 hours*
 - ▷ *whether a separate thermometer (not included) shows the correct value*
 - ▷ *whether the installation location is close to a heat source*
- ▶ F4 appears in the display:
 - ▷ *A fault may have developed in the temperature sensor. The device continues to operate in emergency mode. Avoid opening the lid too frequently or for too long. Please contact your specialist dealer.*

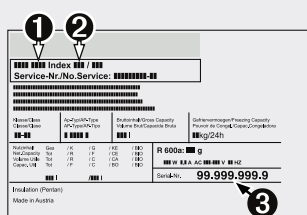

If none of the abovementioned causes exist and you cannot resolve the problem yourself, then please contact your specialist dealer. Provide them with the ❶ type designation, ❷ index and ❸ device number shown on the type plate. The type plate is located on the upper right side wall of the cabinet. Keep the cabinet lid closed if a fault develops. This delays the loss of cooling, the temperature increase, and a possible defrosting.

16 Decommissioning

If the device is to be placed out of operation for a long period of time: Switch off the device, remove the fuse and disconnect the battery or pull the power plug. Clean the device and leave the cabinet lid open to avoid the formation of odors.

The seal integrity of the cooling circuit should be checked.

The device has RF suppression in accordance with EN 55014, which reflects the EC regulation 2004/108/EEC.

The manufacturer is continually developing and improving all types and models. Please therefore understand that we must reserve the right to make changes in form, features, and technology.

17 Technical data

17.1 Electrical data

Steca PF166-H/PF240-H		
System voltage	12 V	24 V
Input voltage range	9.6 V to 17 V	21.3 V to 31.5 V
Deep discharge protection	10.4 V	22.8 V
Automatic switch-on threshold	11.7 V	24.2 V
Power consumption	50 – 72 W	
Recommended fuses	15 A	7.5 A

17.2 Device data

	Steca PF166-H	Steca PF240-H
Cooling method	compressor	
Automatic energy-saving mode	yes	
Energy optimized speed control	Full digital and electronic control system	
Configurable	yes	
Display	digital temperature display in lid	
Celsius / Fahrenheit temperature display	adjustable	
Display brightness	adjustable	
Usable cooling volume	166 litre 5,9 ft ³	240 litre 8,5 ft ³
Refrigerator or freezer function	adjustable	
Adjustable internal temperature	yes	
Refrigerator temperature range	2 °C 36 °F – 12 °C 54 °F	
Freezer temperature range	-20 °C -4 °F – -10 °C 14 °F	
Ambient temperature range	10 °C 50 °F – 43 °C 109 °F	
Hanging baskets	2	
Freezer trays	3	
Lock	yes	
Cold battery	1	
External dimensions A x B x C	91.7 x 87.2 x 70.9 cm 36.1 x 34.3 x 27.9 inch	91.9 x 128.8 x 76 cm 36.2 x 50.7 x 29.9 inch
Weight	47 kg 104 lbs	62 kg 137 lbs

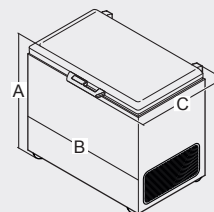

18 Warranty terms

Find the Steca warranty terms on internet at:

www.steca.com/pv-off-grid/warranties



760180