

Relay Module - PLC-RPT-230UC/21AU - 2900311

Please be informed that the data shown in this PDF Document is generated from our Online Catalog. Please find the complete data in the user's documentation. Our General Terms of Use for Downloads are valid (<http://download.phoenixcontact.com>)



PLC-INTERFACE, consisting of PLC-BPT.../21 basic terminal block with push-in connection and plug-in miniature relay with multi-layer gold contact, for mounting on DIN rail NS 35/7,5, 1 PDT, input voltage 230 V AC/220 V DC

Your advantages

- Slim design
- Efficient connection to system cabling using V8 adapter
- RT III sealed relay
- Safe isolation according to DIN EN 50178 between coil and contact
- Integrated input circuit and interference suppression circuit
- Functional plug-in bridges



Key commercial data

package_quantity	10
GTIN	4046356509244

Technical data

Note

Utilization restriction	EMC: class A product, see manufacturer's declaration in the download area
-------------------------	---

Dimensions

Width	6.2 mm
Height	80 mm
Depth	94 mm

Ambient conditions

Ambient temperature (operation)	-40 °C ... 55 °C
Ambient temperature (storage/transport)	-40 °C ... 85 °C

Coil side

Nominal input voltage U_N	230 V AC
Nominal input voltage U_N	220 V DC
Typical input current at U_N	3.2 mA (at $U_N = 230$ V AC)
Typical input current at U_N	3 mA (at $U_N = 220$ V DC)

Relay Module - PLC-RPT-230UC/21AU - 2900311

Technical data

Coil side

Typical response time	7 ms
Typical release time	15 ms
Protective circuit	Bridge rectifier Bridge rectifier
Operating voltage display	Yellow LED
Power dissipation for nominal condition	0.74 W

Contact side

Contact type	1 PDT
Type of switch contact	Single contact
Contact material	AgSnO, hard gold-plated
Maximum switching voltage	30 V AC
Maximum switching voltage	36 V DC
Minimum switching voltage	100 mV (at 10 mA)
Min. switching current	1 mA (at 24 V)
Maximum inrush current	50 mA
Limiting continuous current	50 mA
Interrupting rating (ohmic load) max.	1.2 W (at 24 V DC)

Contact side (with destroyed gold layer)

Note	the following values are applicable if a gold layer is destroyed
Maximum switching voltage	250 V AC/DC
Minimum switching voltage	5 V (at 100 mA)
Limiting continuous current	6 A
Min. switching current	10 mA (at 12 V)
Interrupting rating (ohmic load) max.	140 W (at 24 V DC)
Interrupting rating (ohmic load) max.	20 W (at 48 V DC)
Interrupting rating (ohmic load) max.	18 W (at 60 V DC)
Interrupting rating (ohmic load) max.	23 W (at 110 V DC)
Interrupting rating (ohmic load) max.	40 W (at 220 V DC)
Interrupting rating (ohmic load) max.	1500 VA (for 250 V AC)
Switching capacity in acc. with DIN VDE 0660/IEC 60947	2 A (at 24 V, DC13)
Switching capacity in acc. with DIN VDE 0660/IEC 60947	0.2 A (at 110 V, DC13)
Switching capacity in acc. with DIN VDE 0660/IEC 60947	0.1 A (at 220 V, DC13)
Switching capacity in acc. with DIN VDE 0660/IEC 60947	3 A (at 24 V, AC15)
Switching capacity in acc. with DIN VDE 0660/IEC 60947	3 A (at 120 V, AC15)
Switching capacity in acc. with DIN VDE 0660/IEC 60947	3 A (at 230 V, AC15)

Connection data input side

Connection name	Coil side
Connection method	Push-in connection
Stripping length	8 mm
Conductor cross section solid	0.14 mm ² ... 2.5 mm ²
Conductor cross section flexible	0.14 mm ² ... 2.5 mm ²

Relay Module - PLC-RPT-230UC/21AU - 2900311

Technical data

Connection data input side

Conductor cross section AWG	26 ... 14
------------------------------------	-----------

Connection data output side

Connection name	Contact side
Connection method	Push-in connection
Stripping length	8 mm
Conductor cross section solid	0.14 mm ² ... 2.5 mm ²
Conductor cross section flexible	0.14 mm ² ... 2.5 mm ²
Conductor cross section AWG	26 ... 14

General

Test voltage relay winding/relay contact	4 kV AC (50 Hz, 1 min.)
Operating mode	100% operating factor
Degree of protection	RT III (Relay)
Degree of protection	IP20 (Relay socket)
Mechanical service life	2 x 10 ⁷ cycles
Flammability rating according to UL 94	V0
Mounting position	any
Assembly instructions	In rows with zero spacing

Standards and Regulations

Connection in acc. with standard	CUL
Designation	Standards/regulations
Standards/regulations	IEC 60664
Standards/regulations	IEC 60664A
Standards/regulations	DIN VDE 0110
Standards/regulations	DIN EN 50178/DIN VDE 0160 (in relevant parts)
Standards/regulations	DIN EN 50178/VDE 0160
Standards/regulations	IEC 60255/DIN VDE 0435 (in relevant parts)
Degree of pollution	3
Overvoltage category	III
Flammability rating according to UL 94	V0

Environmental Product Compliance

China RoHS	Environmentally Friendly Use Period = 50
China RoHS	For details about hazardous substances go to tab "Downloads", Category "Manufacturer's declaration"

Classifications

eCl@ss

eCl@ss 5.0	27371601
eCl@ss 5.1	27371601
eCl@ss 6.0	27371601

Relay Module - PLC-RPT-230UC/21AU - 2900311

Classifications

eCl@ss

eCl@ss 7.0	27371601
eCl@ss 8.0	27371601
eCl@ss 9.0	27371601

ETIM

ETIM 2.0	EC001437
ETIM 3.0	EC001437
ETIM 4.0	EC001437
ETIM 5.0	EC001437
ETIM 6.0	EC001437







UNSPSC

UNSPSC 6.01	30211916
UNSPSC 7.0901	39121515
UNSPSC 11	39121515
UNSPSC 12.01	39121515
UNSPSC 13.2	39122334

Approvals

UL Recognized / UL Listed / cUL Recognized / cUL Listed / EAC / RC FRT / EAC / DNV GL / cULus Recognized / cULus Listed /

Approval details

- UL Recognized** 
- UL Listed** 
- cUL Recognized** 
- cUL Listed** 
- EAC** 
- RC FRT** 
- ERC**
- DNV GL**
- cULus Recognized** 

Relay Module - PLC-RPT-230UC/21AU - 2900311

Approvals

cULus Listed

Accessories

DIN rail

NS 35/ 7,5 V2A UNPERF 2000MM - 0801377

NS 35/ 7,5 PERF 2000MM - 0801733

NS 35/ 7,5 CU UNPERF 2000MM - 0801762



NS 35/15 UNPERF 2000MM - 1201714



NS 35/15 CU UNPERF 2000MM - 1201895



Relay Module - PLC-RPT-230UC/21AU - 2900311

Accessories

NS 35/15-2,3 UNPERF 2000MM - 1201798



NS 35/15 AL UNPERF 2000MM - 1201756



NS 35/15 PERF 2000MM - 1201730



NS 35/ 7,5 UNPERF 2000MM - 0801681

Power module

PLC-ESK GY - 2966508



Partition plate

Relay Module - PLC-RPT-230UC/21AU - 2900311

Accessories

PLC-ATP BK - 2966841



Screwdriver tools

SZF 1-0,6X3,5 - 1204517



Controller board

PLC-V8/FLK14/IN - 2296553



PLC-V8/FLK14/IN/M - 2304115



PLC-V8/D15S/IN - 2296074



Relay Module - PLC-RPT-230UC/21AU - 2900311

Accessories

PLC-V8/D15B/IN - 2296087



Terminal marking

ZB 6:UNBEDRUCKT - 1051003



ZB 6/WH-100:UNBEDRUCKT - 5060935



Labeled terminal marker

ZB 6,LGS:FORTL.ZAHLEN - 1051016



Bridge

FBST 500-PLC RD - 2966786



Relay Module - PLC-RPT-230UC/21AU - 2900311

Accessories

FBST 500-PLC BU - 2966692



FBST 500-PLC GY - 2966838



FBST 6-PLC RD - 2966236



FBST 6-PLC BU - 2966812



FBST 6-PLC GY - 2966825



FBST 8-PLC GY - 2967688



Relay Module - PLC-RPT-230UC/21AU - 2900311

Accessories

Drawings

Circuit diagram

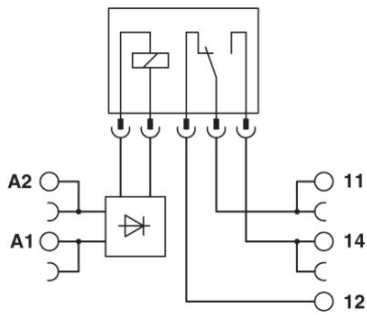

Phoenix Contact 2016 © - all rights reserved
<http://www.phoenixcontact.com>