

sygonix®

Ⓒ Operating Instructions

Transponder code lock - Part 2 (split decoder)

Item no. 1582599 / for surface mounting

Item no. 1582600 / for flush mounting

Page 2 - 67

CE

TABLE OF CONTENTS



	Page
1. INTRODUCTION	4
2. EXPLANATION OF SYMBOLS	4
3. INTENDED USE	5
4. DELIVERY CONTENT	5
5. FEATURES AND FUNCTIONS	6
6. SAFETY INSTRUCTIONS	7
7. INSTALLATION PRECAUTIONS	7
8. OPERATING ELEMENTS	8
a) DA-2800 (OPTIONAL) -- SPLIT-DECODER WITH REMOTE CONTROL RECEIVER	8
b) DA-2801 -- SPLIT-DECODER	10
9. CONNECTION TERMINALS	12
10. SETTING UP A SPLIT-DECODED KEYPAD SYSTEM	16
11. PREPARATION FOR PROGRAMMING	19
a) CRITERIA FOR CODES AND CARDS	19
b) SECURITY LEVEL OF THE OPERATION MEDIA	19
c) LIST OF USER INFORMATION	20
12. PROGRAMMING & OPERATION	21
a) POWER-UP THE KEYPAD	21
b) SET KEYPAD IN PROGRAMMING MODE WITH MASTER CODE	21
c) DIRECT ACCESS TO PROGRAMMING MODE WITH "DAP" CODE -- 2 8 2 8	21
d) SYSTEM REFRESHING WITH "REFRESHING CODE" --- 9 9 9 9	22
e) THE DEFAULT VALUES AFTER REFRESHING	22
13. MASTER CODE -- Location 01	23
14. SUPER USER CODE -- Location 02	24
15. COMMON USER CODES FOR OUTPUT 1, 2 & 3 -- Locations 03, 04, & 05	26
16. USER CODES / CARDS FOR OUTPUT 1, 2 & 3 -- Locations 10, 20 & 30	27
17. VISITOR CODES (FOR OUTPUT 1 ONLY) -- Location 40	31
18. DURESS CODES (FOR OUTPUTS 1, 2 & 3) -- Locations 41, 42 & 43	33
19. OUTPUT MODE & TIMING FOR OUTPUT 1, 2 & 3 -- Locations 51, 52 & 53	35
20. SYSTEM REAL-TIME-CLOCK -- Location 55	36
21. START & STOP TIMES FOR DAILY INHIBITION OF OUTPUT 1 -- Location 56	37
22. PERSONAL SAFETY AND SYSTEM LOCK-UP -- Location 60	39
23. USER CODE ENTRY MODE -- AUTO OR MANUAL -- Location 70	39

24. PACIFIER TONES ON-OFF SELECTION -- Location 7140

25. OUTPUT OPERATION ANNOUNCER -- Location 7241

26. STATUS LED FLASHING ON-OFF DURING STANDBY -- Location 73.....41

27. DOOR FORCED OPEN WARNING & TIMING -- Location 8042

28. DOOR PROPPED-UP WARNING & THE DELAY TIME -- Location 81.....43

29. EGRESS DELAY, WARNING AND ALARM -- Location 90.....45

30. DOOR OPENING ALARM & TIMER -- Location 91.....47

31. WIEGAND DATA OUTPUT MODES -- Location 92.....48

32. WIEGAND DATA OUTPUT FORMAT -- Location 93.....49

33. OPERATION MODES -- Location 94.....50

34. CLOSE PROGRAMMING MODE -- * *50

35. PROGRAMMING MAKE SIMPLE – FOR GENERAL USERS51

36. WIEGAND OUTPUT FORMATS FOR ADVANCED KEYPADS.....53

37. PROGRAMMING SUMMARY CHART56

38. APPLICATION EXAMPLES.....59

 a) BASIC WIRINGS OF A SPLIT-DECODED ACCESS CONTROL DOOR LOCK59

 b) A SPLIT-DECODED ACCESS CONTROL DOOR LOCK WITH AUXILIARY KEYPAD.....60

 c) A DUAL KEYPAD SPLIT-DECODED ACCESS CONTROL INTER-LOCK SYSTEM.....61

39. APPLICATION HINTS FOR THE AUXILIARY TERMINALS.....63

40. THE OPTIONAL AUXILIARY READERS & KEYPADS.....65

41. AUXILIARY INFORMATION.....66

42. TECHNICAL DATA.....67

1. INTRODUCTION

Dear customer,

Thank you for purchasing this product.

This product complies with the statutory national and European requirements.

To maintain this status and to ensure safe operation, you as the user must observe these operating instructions!



These operating instructions are part of this product. They contain important notes on commissioning and handling. Also consider this if you pass on the product to any third party. Therefore, retain these operating instructions for reference!

If there are any technical questions, please contact:

International: www.conrad.com/contact

United Kingdom: www.conrad-electronic.co.uk/contact

2. EXPLANATION OF SYMBOLS



The symbol with the lightning in the triangle is used if there is a risk to your health, e.g. due to an electric shock.



The symbol with the exclamation mark in the triangle is used to indicate important information in these operating instructions. Always read this information carefully.



The arrow symbol indicates special information and advice on operation.

3. INTENDED USE

DA-2800 and DA-2801 are full feature self-contained split-decoders. They are specially designed to work with the keypads in DK-2800 MK-II series and up-grade them for split-decoded operation.

Any keypad of DK-2800 MK-II can be up-graded to full feature operation once it is linked up with the split-decoder even it is originally a low cost, most basic keypad.

The DK-2800 MK-II keypad changes its role as a server in split-decoded operation. It also serves the auxiliary keypads and readers in the system.

DA-2800 and DA-2801 work in the voltage range of 12-24VDC. They are compatible with all the keypads of 12VDC and 12-24VDC in the DK-2800 MK-II series.

Two full feature split-decoders are available. They are DA-2800 and DA-2801.

- **DA-2800** – Full Feature Split-Decoder with RF Remote Control
- **DA-2801** – Full Feature Split-Decoder

DA-2800 is supplied with two remote control keyfobs. Its receiver is also compatible with the optional wireless keypad DK-2310.

It is intended for indoor use only. Do not use it outdoors. Contact with moisture, e.g. in bathrooms, must be avoided under all circumstances.

For safety and approval purposes, you must not rebuild and/or modify this product. If you use the product for purposes other than those described above, the product may be damaged. In addition, improper use can result in short circuits, fires, electric shocks or other hazards. Read the instructions carefully and store them in a safe place. Make this product available to third parties only together with its operating instructions.

All company names and product names are trademarks of their respective owners. All rights reserved.

4. DELIVERY CONTENT

- Split decoder DA-2801

→ Please see Part 1 of these operating instructions for detailed delivery content.

Up-to-date Operating Instructions

Download the latest operating instructions at www.conrad.com/downloads or scan the QR code shown. Follow the instructions on the website.



5. FEATURES AND FUNCTIONS

- Fully Compatible with All The Keypads of DK-2800 MK-II Series for Split-decoded Operation
- Full Feature Signal Decoding for Tri-Tech Operation
- Simple Three Wire Connection for Split-decoded Data Communication; (+), (-) & Data I/O
- Compatible with All The Keypads of 12V/DC and 12-24V/DC Operations
- Three Form C Relays with N.C. and N.O. Dry Contacts
- All Relay Outputs Are Configurable with Auto Reset Timer Mode or Start / Stop Mode.
- Compatible with Fail-safe or Fail-secure Electric Door Lock
- Built-in Door Chime
- Built-in Siren for Tamper, Door Forced Open & Door Propped-up
- Current Limited Power Source (750mA Max.) for Server Keypad
- Accepts Auxiliary Keypads And Readers for Multi-station Operations
- Built-in Control Logic Circuit for High Security Dual Door Inter-lock System
- Built-in Real-Time-Clock Controls The Start and Stop Times in Daily Operation
- Timing Re-lock or Auto Re-lock for The Door After Entry Prevents "Tail-gate" Follower
- Maximum 1,000 Users for Controlling Output 1 and 100 Users Each for Outputs 2 and 3
- Multi-task Super User Code for Inhibiting (Refuse Access), Overriding Door Lock (Keep Door Open); and Operating The Outputs at Any Time under Lock-up Condition for Safety
- Duress Code for Door Opening and at The Same Time Reporting Event of Duress
- 50 Visitor Codes for Temporary Workers and Visitors, Which Expire after Use or The Programmable Time of 1-99 Hours
- Three Programming Options for System Safety Lock-up after Successive False Code Entry
- Auto or Manual User Code Entry Mode for User Convenience And Security Enhancement
- Pacifier Tone And Door Open Announcer Can Be OFF for Silent Environment
- Standby Flashing LED Indicator Can Be OFF for People Do Not Like Flashing LED at Night
- Six Egress Delay and Warning Options for User Convenience and Security Enhancement
- Alarm Signal & Key Button Active Signal Outputs for Triggering Optional Equipments

For Server Keypads with EM Card Reader And/Or Wiegand Data Output

- User Code, EM Card and EM card + User Code Concurrent Operations
- Compatible with 125 Khz Manchester 64-bit EM4100 & EM4200 EM Cards and Keyfobs
- 26-bit, 34-bit or 37-bit Wiegand Data Output Format Selectable

6. SAFETY INSTRUCTIONS

→ For safety instructions please refer to Part 1 of these operating instructions.

7. INSTALLATION PRECAUTIONS



Please study the manual to become familiar with all the specifications and features of the system before installation.

IMPORTANT NOTE TO INSTALLER

- The operation voltage of the DK-2800 MK-II series keypads consist of 12V/DC and 12-24V/DC versions while the Split-Decoders DA-2800 and DA-2801 are 12-24V/DC.
- The operation voltage of the Split-decoded keypad system is 12V/DC only if the associated keypad is 12VDC version.
- The operation voltage of the Split-decoded keypad system can be 12-24V/DC if the associated keypad is 12-24V/DC version.
- Please consult your keypad manual for the correct Operation Voltage before applying power to the system.

Installation Location – The Keypad Unit

- The EM card reader is working at the frequency of 125Khz. Make sure the installation location has no equipment generating strong low frequency electro-magnetic wave in the range of 100-200Khz.
- If more than one keypads working at the same frequency are installed closely in the near locations (for example, a server keypad and an auxiliary keypad-reader are installed back to back inside and outside of the house on the same wall), it is necessary to make sure they are at least 60cm (2 ft) apart from each other to prevent interference.

Installation Location – The Split-decoder Unit

- Do not install the decoder unit close to the electric power cables that emit strong electro-magnetic wave.
- The receiver unit of the DA-2800 is working at the UHF frequency band 433Mhz. To get best result of receiving the signal from the remote keyfobs or the wireless keypad a correct installation location is necessary.
- Install it in a location inside the house facing to the open space and there has no strong RF equipment near it.
- Do not install it in a concrete room or under a concrete stair, which shortens the control distance.

Prevent Unintended Short Circuit

- In the previous experience, most of the damages caused in installation are accidentally touched of the components on the circuit board with the wires carrying power. DO NOT apply power to the system while it is in installation.
- Check carefully all the wirings are correct before applying power to the keypad system for testing.

Power Supply for The System

A good power supply is very important to the stability of the keypad system. Make sure it can provide sufficient power for the whole system especially the appliance taking heavy power to operate. Make sure no large voltage fluctuation when the appliance starts and stops operation if the keypad is supplied from the same power source.

Electric Spikes And Voltage Fluctuation

It is important to prevent the electric spikes feed-in to the keypad. Make sure the diode or MOV provided is connected across the power input terminal of the electric lock, solenoid or motor. It may need a separate power supply for the electronic devices (the keypad system) if the controlled device generates serious voltage fluctuation and strong electric spikes in starting or stopping operation.

8. OPERATING ELEMENTS

a) DA-2800 (OPTIONAL) -- SPLIT-DECODER WITH REMOTE CONTROL RECEIVER

THE FRONT

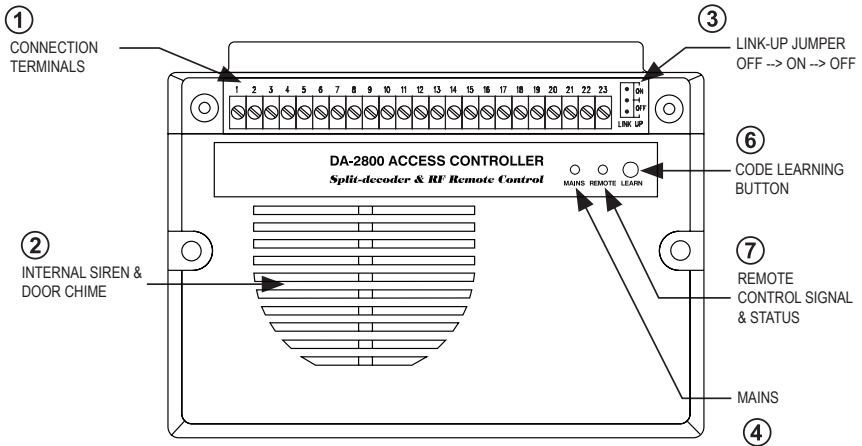

THE MAIN CIRCUIT BOARD

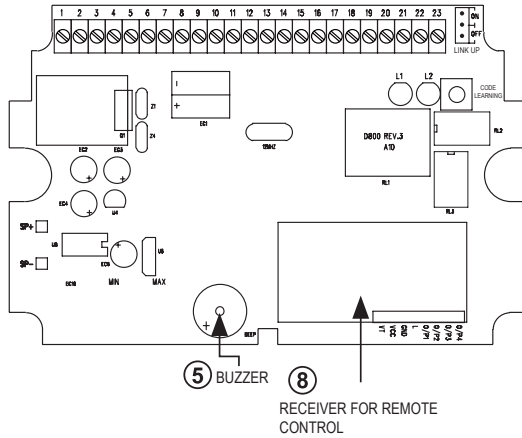

The Facilities - DA-2800

Connection Terminals:

See details in "Connection Terminal" section.

Internal Siren & Door Chime:

It gives warble tone alarm siren and dual tone door chime

Link-up Jumper:

A tool for setting up the link with the server keypad, see details in "Jumper Settings and Link-up Procedures" section on page 17.

Mains:

An LED indicator shows the system status:

STATUS	INDICATIONS
Power-up Delay (Split-decoded mode)	Fast flashing for 5 seconds
In Standby or Programming Mode	1 flash / second
Successful Command Received from RF Key	2 flashes

Buzzer:

A buzzer gives audible tones showing the system status:

STATUS	TONES
Power-up Delay (Split-decoded mode)	Continuous beeps for 5 seconds
Successful Command from RF Keyfob	2 short beeps
Output Relay Active	2 beeps short beeps
Egress Delay Warning	Fast beeps
Door Propped-up Warning	Fast beeps
Door Forced Open Warning	Fast beeps and alarm

Code Learning Button:

A tool for recording the code of the RF keys and wireless keypads (optional).

Remote Control Status:

An LED indicator shows the status of the receiver. See page 18 for the indication details.

Receiver:

It is the receiver unit of the RF remote controller. Do Not touch. It has 4 controlling channels and can accommodate up to 40 remote control keyfobs (DA-12) and wireless keypads (DK-2310).

b) DA-2801 -- SPLIT-DECODER

THE FRONT

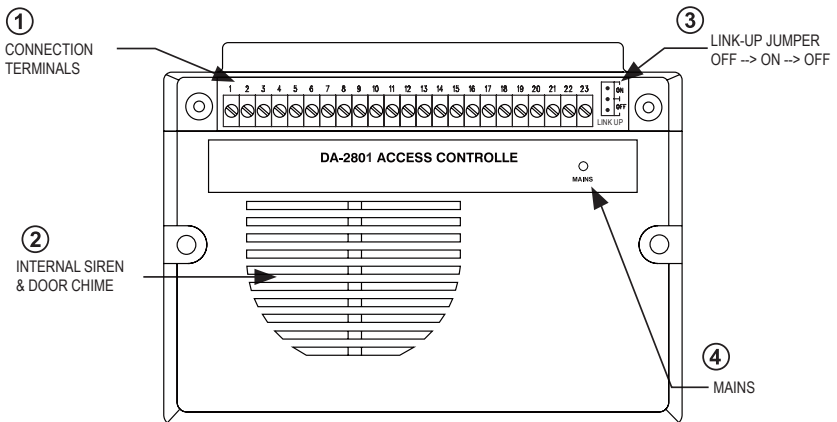

THE MAIN CIRCUIT BOARD

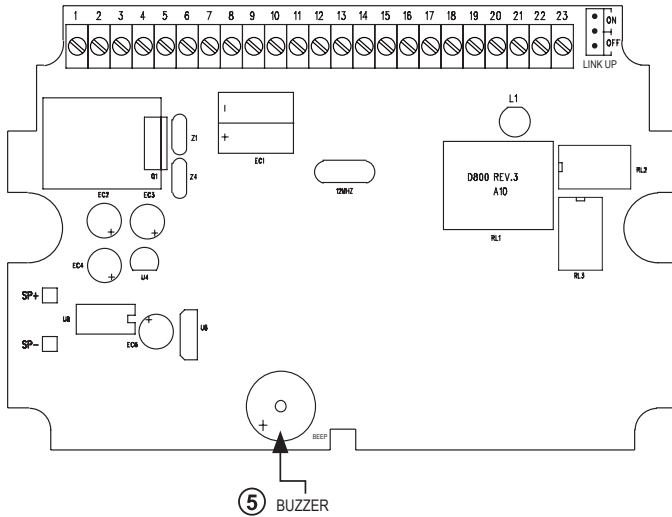

The Facilities - DA-2801

Connection Terminals:

See details in "Connection Terminal" section.

Internal Siren & Door Chime:

It gives warble tone alarm siren and dual tone door chime

Link-up Jumper:

A tool for setting up the link with the server keypad, see details in "Jumper Settings and Link-up Procedures" section on page 17.

Mains:

An LED indicator shows the system status:

STATUS	INDICATIONS
Power-up Delay (Split-decoded mode)	Fast flashing for 5 seconds
In Standby or Programming Mode	1 flash / second
Successful Command Received from RF Key	2 flashes

Buzzer:

A buzzer gives audible tones showing the system status:

STATUS	TONES
Power-up Delay (Split-decoded mode)	Continuous beeps for 5 seconds
Successful Command from RF Keyfob	2 short beeps
Output Relay Active	2 beeps short beeps
Egress Delay Warning	Fast beeps
Door Propped-up Warning	Fast beeps
Door Forced Open Warning	Fast beeps and alarm

9. CONNECTION TERMINALS

DA-2800 & DA-2801

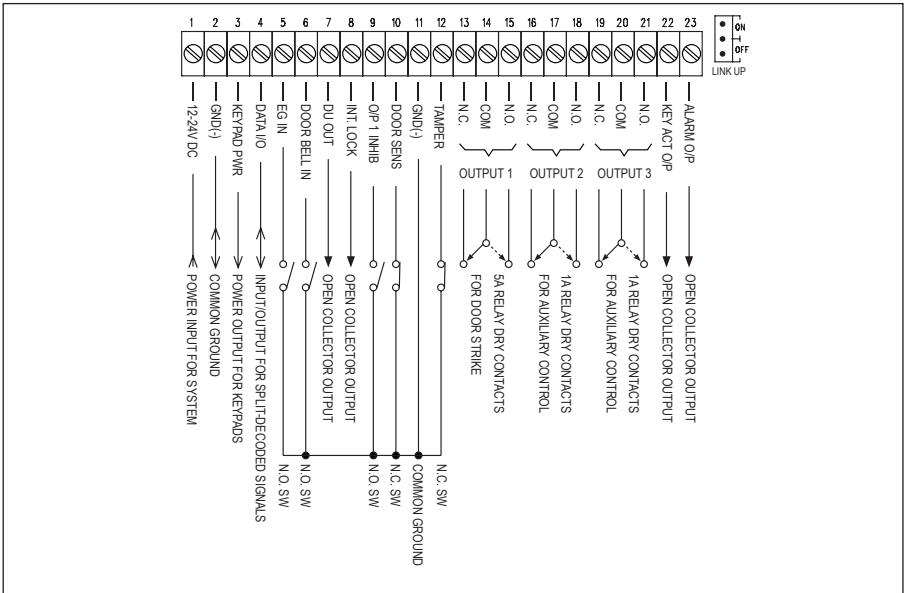

1 - 2: 12-24V/DC I/P -- (Power Input Terminal)

Connect to a 12-24V/DC power supply. The (-) supply and the (-) GND are the common grounding points of the system. The system accepts full input voltage range.

3: KEYPAD POWER O/P -- (Power Output for External Keypads – 500mA Max.)

This power source is prepared for the external keypad(s). Its output voltage follows to the input voltage at terminals 1 - 2 but the output current is limited to 500mA only. This output terminal is protected by a 500mA reset-able fuse to prevent sabotage to the internal power supply of the system in short circuit from the external keypad.

4: DATA I/O PORT -- (Data Input/Output Port for Split-Decoded Operation)

Connect this terminal with the Data I/O terminal of the server keypad unit to link up system for Split-Decoded operation. The auxiliary keypads or readers can also be connected in parallel to this terminal.

5: EG IN -- (Egress Input)

A Normally Open (N.O.) input terminal referring to (-) ground. With the help of a normally open button to activate Output 1 for door open in the same manner of using the User PINs or Cards on keypad. It follows the Function Mode jumper setting of Start/Stop or Momentary in Stand Alone mode.

Egress button is usually put inside the house near the door for exit convenience. More than one egress buttons can be connected in parallel to this terminal. Leave this terminal open if not used.

6: DOOR BELL IN – (Input Terminal for Optional Door Bell Button)

A terminal prepared for connection of the optional bell button(s) referring to (-) ground to activate the built-in door chime. The button with Normally Open contact (N.O.) is required and more than one buttons can be connected in parallel to the terminal.



No connection is required for split-decoded keypad. The Bell Button of the server keypad operates the built-in door chime via the Data I/O bus.

7: DU OUT -- (Duress Output)

An NPN transistor open collector output with the maximum power rating of 24V/DC/100mA sink. It is equivalent to an N.O. (Normally Open) terminal switching to (-) ground after the entry of Duress Code. Use it to trigger an alarm zone of a security system, or turn on a buzzer to notify a guard. Please see the application hints for more information.

Duress Function is available only in Split-decoded mode with Duress Code programmed from keypad.

8: INTER-LOCK O/P -- (Inter-lock Control Output)

An NPN transistor open collector output with the maximum power rating of 24V/DC/100mA sink. It is OFF at normal condition. It switches to (-) ground immediately for the first 5 seconds after received an operation command for Output 1 or after keying in a valid User Code or reading a Card to operate Output 1. It keeps tying to (-) ground during the Door Position Sensor is open circuit due to door open. Use this output point to make cross wire connection with the associated controller's "O/P 1 Inhibit" point in an Inter-lock system to prevent both doors that can be opened at the same time.

An Inter-lock System:

An inter-lock system is a two-door system that always allows only one of the doors to open during the operation. While one of the doors is opened, the other door keeps close until the open door is re-closed. It prevents the unauthorized people dashing into a protected area.

An inter-lock system needs two keypads or controllers and two door position sensing switches for the two doors. Please see the Application Example for more information

9: O/P 1 INHIBIT -- (Output 1 Inhibit Control Input – Normally Open)

A Normally Open (N.O.) sensing input point for controlling of the Output 1, with this terminal connecting to (-) ground, **the Egress Button and the whole group of Users (PINs & Cards) for Output 1 are disabled.** It is prepared mainly for the cross wire connection with the “Inter-lock O/P” point on the associated controller in an Inter-lock system. The inhibit function also governs the RF remote control key from operating of the Output 1 (if the decoder is DA-2800).

10: DOOR SENS N.C. -- (Door Position Sensing Input -- Normally Close)

A Normally Closed (N.C.) sensing point referring to (-) ground, with the help of a normally closed magnetic contact monitors the open or close state of the door. It initiates the following functions for the system. Connect it with jumper to (-) Ground if not used.

- **Door Auto Re-lock**

The system immediately re-locks the door after it is re-closed before the end of the programmed time for output 1. It prevents unwanted “tailgate” entry.

- **Door Forced Open Warning (available in Split-decoded Mode only)**

The controller generates “door forced open” warning and triggers alarm output instantly once the door is forced to open without using a valid user code, Card or pressing of egress button. The warning lasts as long as the time programmed (1-999 seconds). It can be stopped with the User code or card for output 1 at anytime. See programming Location 80 for the details.

- **Door Propped-up Warning (available in Split-decoded Mode only)**

The controller generates propped-up warning beeps (does not activates alarm output) while the door is left open longer than the allowable time programmed. The warning will last as long as the door is open until it is re-closed. See programming Location 81 for the details.

- **Inter-lock Control**

The inter-lock control output always goes to (-) while the door is open, which gives signal to disable the associated controller in the inter-lock system. See the Inter-lock terminal description for more information.

- **Door Opening Alarm**

Door Opening Alarm is designed for the emergency door only. It always gives alarm when the door is opened unless a valid User Code or Card is used prior to the door is opened. See programming Location 91 for the details.

11: (-) GND -- (Common Ground of The System)

A grounding point of the keypad that is common to terminal 2.

12: TAMPER IN -- (Tamper Switch – Normally Closed Input Terminal)

A Normally Closed (N.C.) input terminal referring to (-) ground. It is prepared for the tamper switch of the keypad connecting to it. When the tamper switch is open circuit it triggers the internal siren and the Alarm Output terminal. Link up this terminal to (-) Ground with jumper if not used.

The alarm lasts for 3 minutes. It is reset-able before expiry with User Code from keypad.

13 - 14 - 15: OUTPUT 1 -- (Output Relay 1)

5 Amp relay dry contact controlled by the Group 1 User Code & Cards in Split-decoded mode or by the RF remote key in Stand Alone mode. It is recommended for door strike. Terminal 13 is Normally Closed contact (N.C.), terminal 15 is Normally Open contact (N.O.) and terminal 14 is the common point of the two contacts. Use N.C. output for Fail-safe locking device; and N.O. output for Fail-secure locking device. The operation time of Output 1 is programmable from the keypad (with Function Jumper on position 1). See programming Location 51 for the details.

16 - 17 - 18: OUTPUT 2 -- (Output Relay 2)

1 Amp relay dry contact controlled by the Group 2 User Code & Cards. It is an auxiliary output ideally for controlling of security system or automatic operator. Terminal 16 is Normally Closed contact (N.C.), terminal 18 is Normally Open contact (N.O.) and terminal 17 is the common point of the two contacts.

The operation time of Output 2 is programmable from the keypad (with Function Jumper on position 1). See programming Location 52 for the details.

19 - 20 - 21: OUTPUT 3 -- (Output Relay 3)

1 Amp relay dry contact controlled by the Group 3 User Codes & Cards. It is an auxiliary output ideally for controlling of security system or automatic operator. Terminal 19 is Normally Closed contact (N.C.), terminal 21 is Normally Open contact (N.O.) and terminal 20 is the common point of the two contacts.

The operation time of Output 3 is programmable from the keypad (with Function Jumper on position 1). See programming Location 53 for the details.

22: KEY ACT O/P -- (Keypad Active Output)

An NPN transistor open collector output with the maximum power rating of 24V/DC/100mA sink. It is equivalent to an N.O. (Normally Open) terminal referring to ground. It switches to (-) ground for 10 seconds on each key touch on the keypad or receiving of a command signal from the RF remote key. It can be used to drive a small power device, such as a relay or a low power control point of other equipment. See the Application Hints for more information.

23: ALARM O/P -- (Alarm Output)

An NPN transistor open collector output with the maximum power rating of 24V/DC/100mA sink. It is equivalent to an N.O. (Normally Open) terminal referring to ground. It switches to (-) ground while alarm occurs in order to trigger an external alarm to give notification at remote location. Use it to drive a small power device, such as a relay or a low power control point of other equipment.

The Alarm Output for tamper is 3 minutes fixed. Other alarm outputs are programmable in Split-decoded operation.

THE LINK-UP JUMPER

See page 17 for the details of Link-up procedures of the server keypad to the Split-decoder.

10. SETTING UP A SPLIT-DECODED KEYPAD SYSTEM

Power Supply of The System

DK-2800 MK-II keypads consist of 12V/DC, 12-24V/DC and 12-24V AC/DC operation voltages. Please check the operation voltage of your keypad before applying power to it.

- In split-decoded operation, the keypad system **MUST be DC** operation. AC operation is not allowed.
- For keypads of 12V/DC operation, both keypad and split-decoder are required to operate at 12V/DC.
- For keypads of 12-24V/DC or 12-24V AC/DC operation, both keypad and split-decoder are required to operate at 12-24V/DC.

System Connection

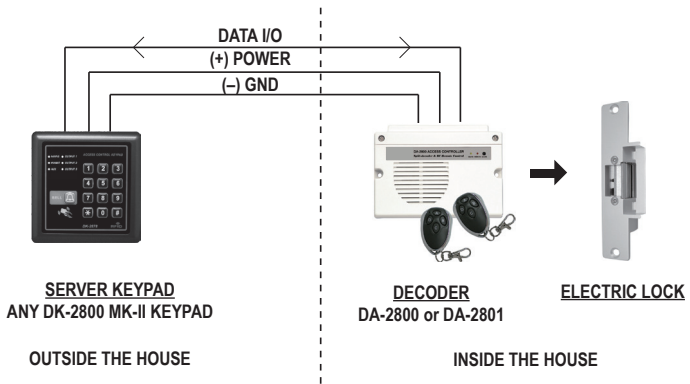

Set Your Keypad to Server Mode

Set your DK-2800 MK-II keypad from keypad mode to **SERVER** mode.

See “**OPERATION MODES -- Location 94**” on page 50 for the programming procedures.

Link Up Connection of Server Keypad and Split-decoder

Three terminals (+), (-) and Data I/O can be found in your DK-2800 MK-II keypad. Connect them with the split-decoder for power and data link-up. No connection is required for other terminals

- Connect the **Data I/O ports** of the Decoder unit (Terminal 4) and the Keypad unit with wire to link up the communication of the two units.
- Connect the **Keypad's (+) power** input terminal to the **Decoder's Keypad PWR** supply (Terminal 3) that supplies power to the keypad with current limit protection of 500mA max.
- Connect the **(-) Common Ground** (Terminal 2) of the Keypad unit and the Decoder unit together making up a return path for the data and the power source.
- This is an optional connection. There is also a pair of **Tamper N.C.** terminals in your keypad; which is a Normally Closed dry contact. It is open circuit while the keypad is separated from its box. Connect these N.C. terminals to the tamper zone (Terminal 12 and Common GND) of the split-decoder to make alarm to alert sabotage.

Jumper Setting for Link-up Procedures

It is necessary to send the Master Code (the link-up code) of the keypad to the decoder for it to recognize the keypad working with it. The decoder will refuse other keypad that is not registered. The keypad will generate warning beep continuous once per second if link-up is unsuccessful.

Link-up Procedures:

- Put the "Link-up Jumper" from **OFF to ON** position (the jumper is located on the main circuit board next to the connection terminals).

OFF → **ON**

- Set the keypad to programming mode with **Master Code**

MASTER CODE * * ---- 2 beeps from keypad

- Set the keypad to exit programming mode and the **Link-up Code** will be sent to the decoder automatically

* * ---- 2 beeps from keypad

- Put the "Link-up Jumper" back to **OFF** position to lock the code in decoder after link-up

ON → **OFF**

- Always keep "Link-up Jumper" on **OFF** position in normal operation

→ Split-decoded keypad requires link-up **Only Once** unless the master code is changed. The link-up code in the decoder (same as the master code in keypad) is protected. It is not affected due to the keypad in programming mode. However, the system requires link-up again if the Master Code of the keypad has been changed.

ALARM OUTPUT & WARNING

1) Tamper ALarm:

- The alarm is triggered via the "Tamper In" terminal
- Alarm Output and Internal Siren activate
- The alarm period is fixed in 3 minutes
- It can be reset with **SUPER USER CODE** # 1 or an user Code/Card in Group 1

Alarm & Warning in Split-decoded Operation

2) The Egress Delay Alarm

- The Egress Delay Alarm is enabled by programming from keypad at Programming Location 90
- The alarm activates during the egress Delay period
- Alarm Output and Internal Siren activate

3) Egress Delay Warning:

- The Egress Delay Warning is enabled by programming from keypad at Programming Location 90
- The warning activates during the Egress Delay period
- The warning beep is given by the internal buzzer only

4) Door Open Alarm (Designed for Emergency Door):

- The Door Open Alarm is enabled by programming from keypad at Programming Location 91
- Alarm Output and Internal Siren activate
- Alarm happens in door forced to open or normal open with Egress Button
- No Alarm happens in door open with User Code or Card

5) Door Forced Open Alarm:

- The Door Forced Open Alarm is enabled by programming from Keypad at Programming Location 80
- Alarm Output and Internal Siren activate
- Alarm happens in door forced to open only
- No Alarm happens in door open with Egress Button, User Code and Card

—————> If both alarms (4) & (5) are enabled in the programming, the system will take the longer one for alarm time.

6) Door Propped-up Warning

- The Door Propped-up Warning is enabled by programming from keypad at Programming Location 81
- The warning starts at the expiry of the propped-up delay
- The warning beep is given by the internal buzzer only

AUDIBLE & VISIBLE STATUS INDICATIONS OF THE KEYPAD

The internal buzzer and the status LED (usually the center LED or the LED named "MAINS" on the keypad) give the following tones and signals respectively for system status:

STATUS	TONES	STATUS LED
In Programming Mode	-----	ON
Successful Key Entry	1 Beep	1 Flash
Successful Code / Card Entry	2 Beeps	2 Flashes
Unsuccessful Code / Card Entry	5 Beeps	5 Flashes
Power Up Delay	Continuous Beeps	Continuous Flashes
Output Relay Activation	1 Long Beep	-----
In Standby	-----	1 Flash / Second
System Refreshing	-----	Fast Flashing for 2.5 Minutes
Card or Code Was Stored In System	1 Long Beep	-----
Keypad Link-up With Decoder Failed	Continuous 1 Beep/1 sec	-----
Real-time-clock Stopped After Power Failure	Continuous 3 Fast Beeps/5 secs	-----

—————> * All Pacifier Tones can be ON or OFF through the programming option at Location 71

** The Output Relay Activation beep can be selected through the programming option at Location 72

*** The Standby flashing can be ON or OFF through the programming option at Location 73

11. PREPARATION FOR PROGRAMMING

a) CRITERIA FOR CODES AND CARDS

Prime Codes

The prime codes include the **a) User Codes, b) Master Code, c) Duress Codes, d) Super User Codes, e) Common User Codes and f) Visitor Codes**. All these codes **MUST** be unique. It is not allowed to repeat a prime code for second function.

All the codes in this system can be 4-8 digits for Manual Entry Mode. The codes must be in the same digit length with the Master Codes for Auto Entry Mode. See Location 70 for the details.

Prime Cards

All the User Cards are prime cards. They are not allowed to program for second function. e.g. a card was programmed for operating output 1 is not allowed for output 2.

The cards used in this system are 125 KHz proximity EM cards.

Secondary User Codes

A Secondary User Code is prepared to enhance the security of an user card, which is a code put after a card. The keypad requires both card and code are correct to grant an entry. The secondary code can be repeatedly used for a group of cards; or proprietary with one code for one card.

→ The keypad will reject repeated use of prime card or prime code in programming and give one long beep indication.

b) SECURITY LEVEL OF THE OPERATION MEDIA

The keypad provides 5 operation Media for owner's selection of security level. See programming Location 10, 20 & 30

EM Card Only – Operation Media 1

A general way for access control, just simply read a card to open the door. Security level is moderate but it is user convenient.

User Code Only – Operation Media 2

A general way for access control, just simply enter a code to open the door. Security level is moderate but it is user convenient.

EM Card + Common User Code – Operation Media 4

The keypad requires both Card and Common User Code are correct to grant an entry. Common User Code is an user code for all the cards. Two media are used in door control. The security level is better than just card or user code alone.

This operation mode can also report Duress Alarm by keying the duress code instead of common user code in emergency when the user is forced to open the door.

EM Card + Group Secondary User Code – Operation Media 3

A secondary user code can be repeatedly used for a group of cards in a department. Owner can make a proprietary department code for each department in a company. Only the staff of the department holding a card and knowing the code is accepted to enter. This approach increases the departmental security and prevents a lost card picked up by other group of people in the company to open the door.

This operation mode can also report Duress Alarm by keying the duress code instead of common user code in emergency when the user is forced to open the door.

EM Card + Proprietary Secondary User Code – Operation Media 3

The keypad accepts programming with each card having its own proprietary user code to work. It prevents any other people can use the lost card to open the door. Card with proprietary user code approach is ideal for the area that high security is the main concern.

This operation mode can also report Duress Alarm by keying in the duress code instead of Secondary user code in emergency when the user is forced to open the door.

c) LIST OF USER INFORMATION

The keypad can accommodate up to 1,200 users (codes / cards). To avoid confusion and for programming convenience, it is suggested to make a list recording of the user information. It helps the owner to program the user codes and cards smoothly and to trace them afterwards in the future. Here is a suggested format of the list.

List of Users (See page 26-30 for reference)

Example:

User	Name	Location	Function Code	User ID	Code	Card #	Remark
1	John	10	1	001	/	001	Output 1
2	May	20	2	001	1234	/	Output 2
3	Tom	10	3	002	24680	002	Output 1
4	Tracy	10	4	003	COMMON	003	Output 1
5							
6							
7							
8							
9							
10							
11							
12							
13							
14							
15							
16							
--							
1,000							

4. Key in the DAP code **2 8 2 8** and validate it with **↵ ↵**. The Status LED is ON and the keypad is in programming mode like using Master Code. It is ready to accept new programming data as long as you like until exit programming mode.

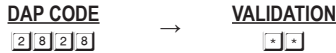

5. To program a new Master Code to replace the old one. See **“Record A Master Code”** stated at **“Location 01”** for the details.

→ The keypad will set itself to normal operation mode 1 minute after power-up if the DAP jumper and DAP code are not operated properly. To set keypad back to power-up mode, repeat procedures 1-4.

Direct access to programming does not affect the stored data in the programming locations.

d) SYSTEM REFRESHING WITH “REFRESHING CODE” --- 9 9 9 9

The keypad can be refreshed by cleaning all the programmed old data and set it back to default values except the **Master Code**.



- Make sure that system refreshing is really required before entering the refreshing code. Refreshing takes few minutes. The status LED (amber) keeps flashing during refreshing. The keypad is back to its default value after refreshing. Re-program of the desired values are necessary.

e) THE DEFAULT VALUES AFTER REFRESHING

LOCATION	PARAMETERS	DEFAULT FUNCTIONS & VALUES
0 1	Master Code	0 0 0 0 Factory Set, Not a default value *
0 2	Super User Codes	Nil ----- User Program Required
0 3	Common User Code 1	Nil ----- User Program Required
0 4	Common User Code 2	Nil ----- User Program Required
0 5	Common User Code 3	Nil ----- User Program Required
1 0	User Codes & Cards for O/P 1	Nil ----- User Program Required
2 0	User Codes & Cards for O/P 2	Nil ----- User Program Required
3 0	User Codes & Cards for O/P 3	Nil ----- User Program Required
4 0	Visitor Codes	Nil ----- User Program Required
4 1	Duress Code for O/P 1	Nil ----- User Program Required
4 2	Duress Code for O/P 2	Nil ----- User Program Required
4 3	Duress Code for O/P 3	Nil ----- User Program Required
5 1	O/P Mode of The O/P 1	Time = 5 Sec, Momentary
5 2	O/P Mode of The O/P 2	Time = 5 Sec, Momentary
5 3	O/P Mode of The O/P 3	Time = 5 Sec, Momentary
5 5	System Real-Time-Clock	Nil ----- User Program Required

LOCATION	PARAMETERS	DEFAULT FUNCTIONS & VALUES
5 6	Start & Stop Time	Nil ----- User Program Required
6 0	Personal Safety & Lock-out	Code = 1, 10 False Code/Card Lock-out 60 Sec
7 0	User Code Entry Mode	Code = 2, Manual Entry Mode
7 1	Pacifier Tones ON-OFF Selection	Code = 1, Pacifier Tone ON
7 2	O/P Operation Announcer	Code = 1 Sec, Notification Beep ON
7 3	Status LED Standby Flashing ON-OFF	Code = 1, Flashing Enabled
8 0	Door Forced Open Warning & Timing	Code = 0, Warning Disabled
8 1	Door Propped-up Warning & Delay	Code = 0, Warning Disabled
9 0	Egress Delay & Warning	Code 1 = 0, Instant, No Delay
		Code 2 = 1, Momentary Contact without Warning
9 1	Door Opening Alarm & Timer	Code = 0, Alarm O/P Disabled
*9 2	Wiegand Output	Code = 1, Disabled
*9 3	Wiegand Output Format	Code = 1, 26-Bit
9 4	Operation Mode	Code = 0, Keypad Mode

→ The DAP Code **2 8 2 8** and the Refreshing Code **9 9 9 9** are fixed in the operating system program. It can not be changed in any ways.

Locations 92 and 93 are available for those keypads with Wiegand Data Output.

13. MASTER CODE -- Location 01

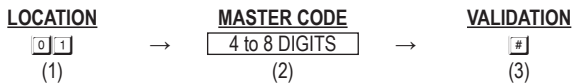

(1) LOCATION

- Key in Location 0 1

(2) MASTER CODE

- Master Code is the authorization code for setting the system to programming mode. It is **NOT** an User Code operating the output relays.
- The Master Code can be 4 to 8 digits.
- When a new master code is keyed in and confirmed, the old master code is replaced.
- The master code is also the **Link-up Code** between the keypad and the Split-decoder.

(3) VALIDATION

- Press # key once. Two-beep confirms the entry.

Example:

Set a Master Code with the number "2 2 3 3" ---- 0 1 2 2 3 3 #

14. SUPER USER CODE -- Location 02

The Super User Code has TWO functions. It is prepared to operate the three outputs and make operation of inhibit enable / disable to those outputs.

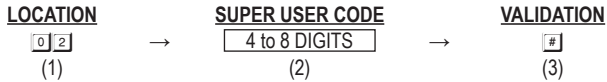

(1) LOCATION

- Key in Location [0] [2]

(2) SUPER USER CODE

- The Super User Code can be 4 to 8 digits.
- When a new Super User Code is keyed in and confirmed, the old one is replaced.

(3) VALIDATION

- Pressing [#] key to confirm code entry.

Example:

- Set a Super User Code "2 5 8 0" ---- [0] [2] [2] [5] [8] [0] [#]
- Deleted a Super User Code from memory: Key in the Location number and #. ---- [0] [2] [#]

OPERATION AND FUNCTIONS OF THE SUPER USER CODE

1) Operate Output 1, 2, and 3

The operation of the Super User Code is just like a normal User Code. Simply key-in the Code with a specific output number for the desired Output. The Super User Code can also be used to reset an operating output timer instantly.

[SUPER USER CODE] [#] [1] ----- Output 1 Activates or Resets

[SUPER USER CODE] [#] [2] ----- Output 2 Activates or Resets

[SUPER USER CODE] [#] [3] ----- Output 3 Activates or Resets

Optional Functions Controlled by Super User Code for Output 1

Apart from controlling of the three outputs 1, 2, and 3; the Super User Code can also be used to enable the optional functions controlling **Output 1** for user convenience or security enhancement.

Super User Code and Egress Button are excluded from any system inhibition and lockup functions; they are valid for door open at anytime for safety.

2) Override The Door Lock Controlled by Output 1 (Keep Door Un-locked)

The Output 1 is usually for door lock control. In some situations, the door may require un-locked for a period of time to allow door opening without User Code or EM Card for entry / exit convenience. This function Starts / Stops in toggle with the following code entry.

[SUPER USER CODE] [#] [7] ----- The Door is Un-locked, Start / Stop in Toggle



The door is un-locked while the function is enabled.

Do not forget to stop this function after use because the door is un-locked. Also, the system refuses the optional functions (3) & (4) while Override function comes into effect.

This feature is **good for all the “Fail-safe electric locks”**.

“**Fail-secure electric lock**” requires power to keep in un-locked condition. It takes high current all the time while the function comes into effect and **may cause damage** to it. This function is not recommended for Fail-secure electric lock.

→ While [SUPER USER CODE] [#] [7] is in operation to hold the door lock open, the functions that rely on the door sensor (such as a magnetic contact) and the User Codes for output 1 are all temporarily suspended until [SUPER USER CODE] [#] [7] is keyed in again to release the door hold function.

The following are the temporarily suspended functions:

- Door Auto-relock
- Door Forced Open Warning (at Location 80)
- Door Propped-up Warning (at Location 81)
- Door Opening Alarm (at Location 91)
- Dual Keypad Inter-lock Operation
- All User Codes Including Super User Code for Output 1
- Duress Output Actuated by The Duress Code for Output 1

3) Pause The Scheduled Daily Inhibition for Output 1 (Temporarily Disable The Inhibition)

The scheduled inhibition can be programmed and applied to Output 1 with daily start and stop times. It can be stopped temporarily if required; such as the staff work overtime after office hours going into the inhibition period. This function Starts / Stops in toggle with the following code entry. It can be done before or during the inhibition period.

[SUPER USER CODE] [#] [8] ----- Door Lock Operation Resumes, Start / Stop in Toggle

→ The “INHIBIT” LED (Red) is ON in inhibition and turns to Flashing while pause is into effect.

See **Programming Locations 55 & 56** for more information Daily Inhibition.

4) Inhibit All The User Codes & EM Cards for Output 1 (Disable Access Control Manually)

To enhance the security of the access control keypad, the owner can stop the keypad after office hour or while the house is nobody inside. Once the Output 1 (for door lock control) is inhibited, all the User Codes / Cards for it become invalid and those people holding the User Code or Card are refused. This function Starts / Stops in toggle with the following code entry.

[SUPER USER CODE] [#] [9] ----- Door Lock Operation Inhibited, Start / Stop in Toggle

→ The door is locked during Output 1 inhibited and the “INHIBIT” LED (Red) is ON.

Inhibition applies to all User Codes and EM Cards for Output 1 only. Output 2 and output 3 are not affected.

15. COMMON USER CODES FOR OUTPUT 1, 2 & 3 -- Locations 03, 04, & 05

The Common User Codes 1, 2 and 3 are prepared for operating of the Output 1, 2 and 3 respectively as an enhance code. The Common User Codes **MUST** work in the form of “Card + Common Code” to operate the outputs to increase the security of the access control system. See Media 4 at Locations 10, 20 & 30 for more information.

→ Common User Code alone can **NOT** operate the Outputs directly.

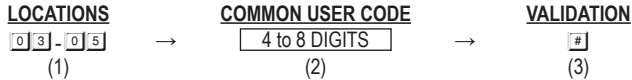

(1) LOCATIONS

0

3

 -- Location Stores The Common User Code for Output 1

0

4

 -- Location Stores The Common User Code for Output 2

0

5

 -- Location Stores The Common User Code for Output 3

(2) COMMON USER CODES

- The Common User Code can be 4 to 8 digits.
- When a new Common User Code is keyed in and confirmed, the old one is replaced.

(3) VALIDATION

- Pressing

#

 key to confirm code entry.

Example:

- Set a Common User Code “1 3 5 7” for Output 1 ----

0

3

1

3

5

7

#
- Deleted a Common User Code from memory: Key in the Location number and #. ----

0

3

#

16. USER CODES / CARDS FOR OUTPUT 1, 2 & 3 -- Locations 10, 20 & 30

Total 1,200 User Codes / Cards are available for controlling of the three outputs.

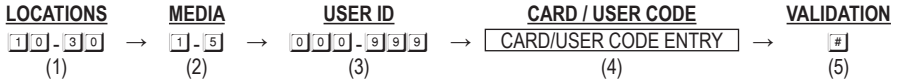

(1) LOCATIONS (User Groups)

1 0 – Group 1 – 1,000 User Codes / Cards for controlling Output 1

2 0 – Group 2 – 100 User Codes / Cards for controlling Output 2

3 0 – Group 3 – 100 User Codes / Cards for controlling Output 3

(2) MEDIA (Operation Media) - please also see page 19-20 for more information of their security level

1 – Cards Only – 125Khz Proximity EM Card

2 – User Codes Only – 4-8 Digits

3 – Cards + Secondary User Code(s) – **See Note (a)**

4 – Cards + Common User Code – **See Note (b)**

5 – Delete Cards / User Codes from the selected User ID – **See Note (c)**

0 9 9 9 – Group Clearing. Clear all the User Codes & Cards of the selected User Group Location. Clearing takes few seconds to a minute.

(3) USER ID (The IDs of The User Codes and Cards)

0 0 0 – **9 9 9** – 1,000 User IDs for the User Codes & Cards in User Group 1 (Output 1)

0 0 1 – **1 0 0** – 100 User IDs for the User Codes & Cards in User Group 2 (Output 2)

0 0 1 – **1 0 0** – 100 User IDs for the User Codes & Cards in User Group 3 (Output 3)

(4) CARD / USER CODE

Read EM Card or key in User Code into each assigned User ID.

(5) VALIDATION

Press the **#** key once. Two-beep confirms the entry.

→ (a) The Secondary User Code is a user code putting after a card in programming. It can be a proprietary user code for each user card or a code repeatedly used for a group of user cards as group user code (e.g. for a group of staff working in the same department).

(b) The Common User Codes for the Output 1, 2 & 3 have been programmed first at Locations 03, 04 & 05 respectively. It is not necessary to key in the code again in programming here and it will follow the card automatically after the card is read.

(c) Deletion of an User Code or Card (if the card was lost) can be done by keying-in its ID number. For deleting an existing cards, simply read the card once and confirm. It does not require the ID number. The Card includes the combinations of (1) Card Only, (2) Card + Secondary User Code and (3) Card + Common User Code.

EXAMPLES – PROGRAMMING AND OPERATION

Example 1 -- EM Card Only:

Programming:

1	0	1	0	0	1	READ CARD	#
---	---	---	---	---	---	-----------	---

(a) (b) (c) (d) (e)

- (a) The card is programmed for operating Output 1
- (b) The operation medium is EM Card only
- (c) Take ID number 001 in Group 1 to store the card, which is one of the IDs in 000-999
- (d) Put the card close to the reader, one beep confirms the reading
- (e) Press # to store the "Card", two-beep confirms a valid entry

Operation: (while the system is back to operation mode)

READ CARD

(a)

- (a) Read the EM card. Two-beep confirms the card is read and Output 1 activates

Example 2 -- Private User Code Only:

Programming:

2	0	2	0	0	1	1	2	3	4	#
---	---	---	---	---	---	---	---	---	---	---

(a) (b) (c) (d) (e)

- (a) The Private User Code is programmed for operating Output 2
- (b) The operation medium is Private User Code only
- (c) Take ID number 001 in Group 2 to store the Private User Code, which is one of the IDs in 001-100
- (d) Put Private User Code "1 2 3 4" into the storage location
- (e) Press # to store the "Private User Code", two-beep confirms a valid entry entry

Operation: (while the system is back to operation mode)

1	2	3	4	#
---	---	---	---	---

(a) (b)

- (a) Key in the Private User Code "1 2 3 4"
- (b) Confirm it with the # key. Output 2 activates

Example 3 -- EM Card + Secondary User Code:

Programming:

1	0	3	0	0	2	READ CARD	2	4	6	8	0	#
---	---	---	---	---	---	-----------	---	---	---	---	---	---

(a) (b) (c) (d) (e) (f)

- (a) Key in the User Group that the User ID belongs to. "10" for Group 1, "20" for Group 2, and "30" for Group 3
- (b) Key in "5" that is the Command Code for making a deletion
- (c) Key in the User ID that stored the User Code, the lost EM card or the EM Card+User Code
- (d) Press the # key. Two-beep confirms a valid entry and the Code and/or Card in that User ID is cleared

Delete an EM Card



- (a) Key in the User Group that the EM Card belongs to. "1 0" for Group 1, "2 0" for Group 2, and "3 0" for the Group 3
- (b) Key in "5" that is the Command Code for making a deletion
- (c) Read the EM card. One-beep confirms the reading. Read the Card only also makes a valid deletion to the Card working with the Common User Code or the Secondary User Code
- (d) Press the # key. Two-beep confirms a valid entry. The EM Card in that User ID is cleared. Key in the User ID is not required.

Example 6 – Clear The Whole Group of Users:

Whole group of users including the Codes and Cards can be cleared with the following command.

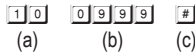

- (a) The User Group 1 – "10" is selected to be cleared. "20" for Group 2 & "30" for Group 3
- (b) Key in the Group Deletion Command, 0 9 9 9
- (c) Confirm the deletion with #. All the User Codes and Cards in Group 1 are cleared. It takes few seconds to a minute to complete depending on the data stored.

Example 7 – Report A Duress While Using EM Card:

The Duress Codes are Prime User Codes in the system. In the "EM Card + Secondary User Code" or "EM Card + Common User Code" operation, they can be used to replace the "Secondary User Code" or the "Common User Code" to operate the specific output and report a duress alarm event. Programming is not required. The system has this function automatically while Duress Code exists.

Operation: (while the system is in the operation mode)



- (a) Read the EM card. Two-beep confirms the reading and 30 seconds waiting time is given for entry of the Duress Code, the Amber LED keeps flashing
- (b) Key in one of the Duress Codes for the specific output (the Code programmed in "Location 41, 42, or 43" for Output 1, 2 and 3 respectively)
- (c) Confirm it with the # key. The specific Output activates in a normal way and the Duress Output also activates to report Duress Event to an alarm system.

→ The Duress Event can not be reported if the operation mode is EM Card alone. It is required to key in the Duress Code directly instead of EM card to report Duress Event.

17. VISITOR CODES (FOR OUTPUT 1 ONLY) -- Location 40

The Visitor Codes are temporary user codes for Output 1 (mainly for door strike in access control). They can be programmed as “One Time Codes” or “Codes with Time Limit”. The Visitor Codes will be cleared automatically after use if they are one time codes, or, when the allowed time expires.

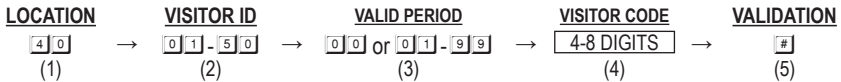

(1) LOCATION

Key in Location

(2) VISITOR ID

- --- 50 Visitor IDs for the 50 visitor codes. The ID is a Two-digit number

--- Clear all the Visitor Codes in Location 40. Please see the Programming example below for the details.

(3) VALID PERIOD

The codes in this box MUST be two digits and they represent the time of operation.

--- One Time Code

One Time Code has no time limit but it can only be used for **ONCE**. It is cleared by the system automatically after use.

- --- Time Limit in Hour(s)

The Visitor Code can be set with the valid time limit of 1 Hour to 99 Hours with a two-digit number of 01 to 99. The visitor code is cleared by the system when the time limit reaches.

(4) VISITOR CODES

- The Visitor Codes can be 4-8 digits for Manual Mode code entry.
- The Visitor Codes MUST be in the same digit length with the Master Code for Auto Mode code entry.
- The Visitor Codes can not reset Duress Output.
- When a new Visitor Code is put in the same Code box, the old code is replaced.

➔ All Visitor Codes will be cleared after power down to prevent extension/confusion of their valid time limit.

(5) VALIDATION:

Press key once. Two-beep confirms the entry.

EXAMPLES:

Example 1: Set a "One Time Visitor Code" with the number of "1 2 6 8" for the Output 1

4	0	0	1	0	0	1	2	6	8	#
---	---	---	---	---	---	---	---	---	---	---

(a) (b) (c) (d) (e)

(a) Visitor Code Programming, (b) The Visitor ID, (c) An One Time Code, (d) The Visitor Code, (e) Entry Confirmation

Example 2: Set a "Visitor Code" with the number of "1 3 7 8" that is valid for three hours

4	0	0	2	0	3	1	3	7	8	#
---	---	---	---	---	---	---	---	---	---	---

(a) (b) (c) (d) (e)

(a) Visitor Code Programming, (b) The Visitor ID, (c) Valid for 3 Hours, (d) The Visitor Code, (e) Entry Confirmation

Example 3: Delete a "Visitor Code" from Visitor ID 02 in the memory

4	0	0	2	#
---	---	---	---	---

(a) (b) (c)

(a) Visitor Code Programming, (b) The Visitor ID, (c) Delete Confirmation

Example 4: Clear all "Visitor Codes" in Location 40

4	0	0	9	9	9	#
---	---	---	---	---	---	---

(a) (b) (c)

(a) Visitor Code Location, (b) The Deletion Command Code, (c) Confirmation, all Visitor Codes are cleared

18. DURESS CODES (FOR OUTPUTS 1, 2 & 3) -- Locations 41, 42 & 43

Duress Codes are prepared for those **Important Persons** in case of **DURESS** while he is operating the access control keypad. The duress code operates like a normal User Code for Output 1, 2 or 3, and at the same time activates the Duress Output without any indication. The user may use it to report an emergency and ask for help silently when he is forced to operate the keypad if the Duress Output is connected with a security system (for example, an Auto-dialer).

→ The Duress Codes are always valid. They are not governed by any inhibit or lockup function in the system.

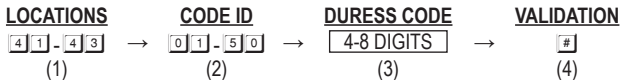

(1) LOCATIONS

[4][1] – Duress Codes for Output 1

[4][2] – Duress Codes for Output 2

[4][3] – Duress Codes for Output 3

(2) DURESS CODE IDS

[0][1] - [5][0] 50 Duress Codes IDs for The Output 1

[0][1] - [1][0] 10 Duress Codes IDs for The Output 2

[0][1] - [1][0] 10 Duress Codes IDs for The Output 3

[0][9][9][9] --- Clear all the Duress Codes from the selected Location group.

Please see the programming example below for the details.

(3) THE DURESS CODES

50, 10 and 10 Duress Codes can be programmed for Output 1, 2 and 3 respectively. They are stored in their two-digit Code ID box. When a new Code is put into the same Code ID box, the old code is replaced.

- The Duress Codes are 4-8 digits for Manual Mode code entry.
- The Duress Codes MUST be in the same digit length with the Master Code for Auto Mode code entry.
- Always set a Duress Code that is easy to remember in Panic Situation. Only one number different from the daily used User Code is highly recommended.
- **Example:** User Code is 1 3 6 9, then 3 3 6 9 or 1 3 6 0 might be a good choice for the Duress Code.
- The **Duress Code** can also be used to **replace the Secondary User Code or Common User Code** in Card reading for the Duress reporting.

(4) VALIDATION:

Press [#] key once. Two-beep confirms the entry.

EXAMPLES:

Example 1: Set a "Duress Code" with the number of "3 3 6 9" for Output 1

4 1	0 1	3 3 6 9	#
(a)	(b)	(c)	(d)

(a) Duress Code for Output 1, (b) Duress Code ID, (c) The Duress Code, (e) Entry Confirmation

Example 2: Set a "Duress Code" with the number of "2 3 9 8 0" for Output 2

4 2	0 1	2 3 9 8 0	#
(a)	(b)	(c)	(d)

(a) Duress Code for Output 2, (b) Duress Code ID, (c) The Duress Code, (e) Entry Confirmation

Example 3: Delete an Output 1 "Duress Code" from Duress Code ID 01 in the memory

4 1	0 1	#
(a)	(b)	(c)

(a) Duress Code for Output 1, (b) The Duress Code ID, (c) Delete Confirmation

Example 4: Clear The Whole Group of Duress Codes from Location 41:

4 1	0 3 9 9	#
(a)	(b)	(c)

(a) Group Location 41, (b) The Group Deletion Command, (c) Confirmation, all Duress Codes in Location 41 are cleared.

OPERATION AND FUNCTION OF THE DURESS CODE

The Duress Code(s) has double actions when it is keyed in. It activates the Duress Output (for duress alarm) and at the same time activates the specific Relay Output 1, 2 or 3 just like a normal User Code. The Duress Code always activates the Relay Output in its group, but, does not de-activate (stop) the Duress Output. **ONLY a normal User Code or Card in anyone of the user groups, or a Super User Code** can reset (de-activate) the Duress Output.

For Example:

Key in The Duress Code 3 3 6 9 of the Group 1 (for Output 1) To Command The Duress Function:

3 3 6 9 #----- Duress Output activates (switches to (-) ground) & Output 1 activates.

Key in The Duress Code 3 3 6 9 in Group 1 (for Output 1) Again:

3 3 6 9 #----- Duress Output keeps activating and no change in its state (keeps to (-) ground) & Output 1 activates again.

Key in A Normal User Code to Reset Duress (For Example: 1369 is An User Code for Output 1):

1 3 6 9 #----- Duress Output resets (back to OFF state) but does not activate Output 1.

Report Duress in EM Card Operation

The Duress Codes are Prime User Codes in the system. In the "EM Card + Secondary User Code" or "EM Card + Common User Code" operation, they can be used to replace the "Secondary User Code" or the "Common User Code" to operate the specific output and report a duress alarm event. Programming is not required. The system has the function automatically while Duress Code exists.

Operation: Taking Duress Code 3 3 6 9 in Group 1 for Output 1 As Example



- a) Read the EM card. Two-beep confirms the reading and 30 seconds waiting time is given for the entry of Duress Code, the Amber LED keeps flashing
- b) Key in the Duress Codes 3 3 6 9 for operating Output 1
- c) Confirm it with the # key. Output 1 activates in a normal way and the Duress Output also activates to report Duress Event to an alarm system if connected.

————> Duress Event can not be reported with EM Card alone. User can only directly use Duress Code to open the door and report duress event in emergency

19. OUTPUT MODE & TIMING FOR OUTPUT 1, 2 & 3 -- Locations 51, 52 & 53

The three relay outputs are programmable for Start/Stop or Timing modes. Apart from door access control, alarm arm-disarm control, they are also **universal timers for automatic operators in industry** with their 99,999 seconds (over 24 hours) programmable timer.

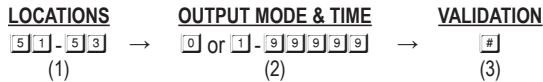

(1) LOCATIONS

5 1 -- Location for Output 1

5 2 -- Location for Output 2

5 3 -- Location for Output 3

(2) OUTPUT MODE & TIMING

0 - Start /Stop Mode (Toggle)

The number 0 sets the output to **Start / Stop mode**. The output **Starts** when an User Code and/or Card is entered/read; the output **Stops** when an User Code and/or Card is entered/read again.

1 - 9 9 9 9 9 9 -- **Seconds Momentary --- (Default -- Momentary 5 Seconds)**

The output can be set in **Momentary Mode** with the time of 1 second to 99,999 seconds. The output will reset automatically when the time expires.

(3) VALIDATION

Press # key once. Two-beep confirms the entry.

RESET OUTPUT TIMER WITH SUPER USER CODE

The Output Timer can be **RESET manually at anytime with the Super User Code** that operates the desired output before the end of the time.

Example:

Reset Output 1 Timer -- ----- Output 1 stops

Reset Output 2 Timer -- ----- Output 2 stops

Reset Output 3 Timer -- ----- Output 3 stops

20. SYSTEM REAL-TIME-CLOCK -- Location 55

This 24 hour real-time-clock provides the daily time base for starting and stopping the function of inhibition to relay output 1 (mainly for electric door lock strike).

No real-time-clock setting is required if daily start-stop inhibition at Location 56 is not enabled.

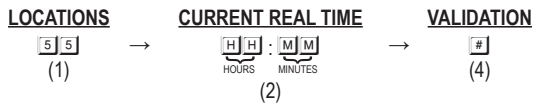

(1) LOCATION

Key in Location

(2) CURRENT REAL TIME

: – The current time in Hour and Minute. The allowed time figure is **00:00 – 23:59**

The time setting is based on 24 hours daily with the **first two digits for hours** and the **last two digits for minutes**. The time in second always starts at 0 0.

(3) VALIDATION

Press key once.

Two-beep confirms the setting and the clock starts to count in 24 hour basis from the programmed current time.

Programming Examples:

- Set the current time of "10:30" (AM) to the keypad ----
- Set the current time of "6:45" (PM) to the keypad -----

→ The real-time-clock stops after power failure, which makes the real-time inhibition loses its time base. **It is necessary to re-program the system's real-time-clock** unless the keypad is back up with UPS.

The keypad gives **warning beeps of 3 fast beeps / 5 seconds continuously after power failure** until the real-time-clock is re-programmed.

No after “**power failure warning beep**” will be given if **Location 56** is not programmed with Start/Stop times.

Suggest to program the clock every 3-6 months to keep time accuracy; or when time deviation is found.

21. START & STOP TIMES FOR DAILY INHIBITION OF OUTPUT 1 -- Location 56

Setting with start and stop times into the keypad, the real-time inhibition period for output 1 will recycle daily until the time settings are cleared.

This function works with the real-time-clock. Set up the real-time at Location 55 is necessary.

For safety reason, the Egress Button is designed always valid. The door lock (controlled by output 1) can be opened with it at anytime during inhibition.

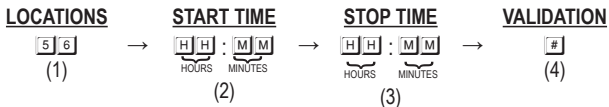

(1) LOCATION

Key in Location **5 6**

(2) START TIME

H H : **M M** – Set the real-time inhibition starting time in Hour and Minute. The allowed time figure is **00:00 – 23:59**

The starting time is based on 24 hours daily with the **first two digits for hours** and the **last two digits for minutes**. The time in second always starts at 0 0.

(3) STOP TIME

H H : **M M** – Set the real-time inhibition stopping time in Hour and Minute. The allowed time figure is **00:00 – 23:59**

The stopping time is based on 24 hours daily with the **first two digits for hours** and the **last two digits for minutes**. The time in second always starts at 0 0.

(4) VALIDATION

Press **#** key once.

Two-beep confirms the setting.

Programming and Operation Examples:

Set the starting and stopping time for the real-time inhibition period

a) Set Inhibition Period from 12:30 PM (today) – 1:30 PM (today) for lunch time:

b) Set Inhibition Period from 6:30 PM (today) – 8:15 AM (next day) for office close:

→ The start and stop time figures are 24 hours basis. They are 4-digit figures from the smallest **00:00** to the largest **23:59**.

Entry of the two figure values from **Small** (Start) to **Large** (Stop) for the period of inhibition; the inhibition will start and stop in the same day. See **example (a)**.

Entry of the two figure values from **Large** (Start) to **Small** (Stop) for the period of inhibition; the inhibition will start at the time of the day; thus stop in the next day. See **example (b)**.

The keypad does not accept the "Start" and "Stop" times with same value. The two time figures must be different.

Clear the function of inhibition

Clear the time settings to stop the function of inhibition:

Pause the real-time inhibition manually

The real-time inhibition can be stopped temporarily if require; such as the staff work overtime in office. The inhibition can be paused manually with Super User Code before or during the inhibition period. The pause is toggle and does not affect the real time period counting.

---- Inhibition paused [Inhibit LED(Red) Flashing]

---- Inhibition resumes [Inhibit LED(Red) ON]

→ The "INHIBIT" LED(Red) is flashing during the paused period; and it is ON after inhibition resumes.

Open door lock with Super User Code at anytime

The Super User code is valid all the time even in the inhibition period. This function does not affect the real time period counting.

---- The door is open

22. PERSONAL SAFETY AND SYSTEM LOCK-UP -- Location 60

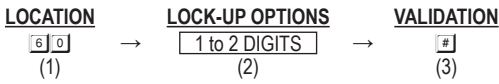

(1) LOCATION

Key in Location 6]0

(2) LOCK-UP OPTIONS

The Options are represented by the following Numbers. They are described below:

- 1 --- After 10 successive false Card/User Code trials, the keypad locks during 60 seconds.
-- (Default)
- 2 --- After 10 successive false Card/User Code trials, activates the Duress output to switch to (-) ground. The Duress Output can be released with any user Code or Card in the User Group 1 or Super User Code.
- 5 - 1]0 --- Selection of after 5 to 10 successive Card/User Code trials, the keypad locks during 15 minutes. The keypad can be reset to release the lock-up with the "Super User Code" in the following way.

Example: Release the lock-up -- SUPER USER CODE #]9

0]0 --- Disappearance of all the above lock-up securities.

(3) VALIDATION

Press # key once. Two-beep confirms the entry

23. USER CODE ENTRY MODE – AUTO OR MANUAL -- Location 70

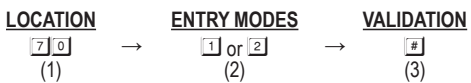

(1) LOCATION

Key in Location 7]0

(2) USER CODE ENTRY MODES

Two modes 1 and 2 are available for User Code entry options. The **EM Card is always in Auto Entry Mode** and is not affected by the selection here.

1 --- Auto Entry Mode

Auto Entry Mode requires no pressing of the # key after code entry for code checking.

In the Auto Entry Mode, the **User Codes MUST be set in the same digit length of the Master Code** (For example, if the Master Code is 5 digits, then all User Codes must be in 5 digits as well. All other User Codes not in 5 digits become invalid). When the number of digits reaches, the system will check the User Code automatically. Good for high traffic access control.

2 --- Manual Entry Mode – (Default)

Manual Entry Mode always requires the # key following the User Code for code checking. The User Codes can be **4-8 digits arbitrar]** and they are **NOT** required to be in the same digit length of the Master Code. Manual Entry increases the level of security in code trial by the unauthorized people.

(3) VALIDATION

Press # key once. Two-beep confirms the entry

24. PACIFIER TONES ON-OFF SELECTION -- Location 71

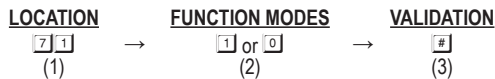

(1) LOCATION

Key in Location 71

(2) FUNCTION MODES FOR PACIFIER TONES

Pacifier Tone is the Beep Tones from the keypad, which include the tones of Successful Key entry (1 beep) and the Unsuccessful User Code/Card entry (5 beeps).

→ The beeps for the Warning and the Power-up Delay do not belong to pacifier tones and can not be OFF.

1 --- Pacifier Tone ON – (Default)

All the Pacifier Tones available from the keypad are enabled. They are the response tones indicating the operation status of the keypad after a Card/User Code is entered.

0 --- Pacifier Tone OFF

All the Pacifier Tones are OFF. Good for place needs for a silent environment.

(3) VALIDATION

Press # key once. Two-beep confirms the entry

25. OUTPUT OPERATION ANNOUNCER -- Location 72

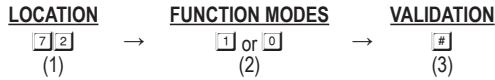

(1) LOCATION

Key in Location 7 2

(2) FUNCTION MODES FOR OUTPUT ANNOUNCER

Output announcer gives notification beep on the operation status of the outputs. There are two notification modes available for the selection. The notification is also OFF while the Pacifier Tone OFF mode in the Location 71 is selected.

→ In multi-station operation, the output announcer only goes to the keypad that has been operated but not all the keypads in the system.

0 --- No Notification

The output operation notification is OFF but does not affect the normal pacifier tones.

1 --- 1 Second Long Notification -- (Default)

1 second notification beep is given when the output relay activates. It is prepared to notify the person outside the door when the lock is released and the door can be opened. It is good for door lock that gives no sound when it activates, such as a magnetic lock.

2 --- 2 Short Beeps Notification

2 short beeps notification is given when the output relay activates.

(3) VALIDATION

Press # key once. Two-beep confirms the entry

26. STATUS LED FLASHING ON-OFF DURING STANDBY -- Location 73

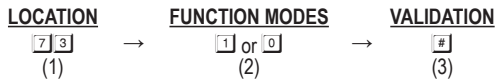

(1) LOCATION

Key in Location 7 3

(2) FUNCTION MODES FOR STANDBY FLASHING LIGHT

Some people find the flashing light of the status LED (the amber LED) is annoying during standby, especially at the night time. The standby flashing can be ON-OFF with the setting here.

1 --- Standby Flashing ON -- (Default)

The Status LED gives Standby Flashing all the time. It also gives the light indications showing the operation status of the system.

0 --- Standby Flashing OFF

The Standby Flashing is OFF but it does not affect the system status indications.

(3) VALIDATION

Press # key once. Two-beep confirms the entry.

27. DOOR FORCED OPEN WARNING & TIMING -- Location 80

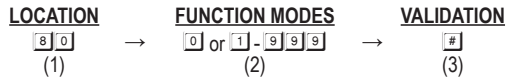

(1) LOCATION

Key in Location 80

(2) FUNCTION MODES FOR DOOR FORCED OPEN WARNING

The Door Forced Open Warning function works with a Door Position Sensing switch equipped on the door (usually a magnetic contact). Once a Timing Figure is put into the Function Mode box, the warning mode is enabled.

0 --- Door Forced Open Warning OFF – (Default)

1 - 999 --- Door Forced Open Warning & Alarm Enabled & Timing

The Timing Figure for the Warning can be 1-999 seconds. The keypad generates the door forced open warning beeps and activates the alarm output (Terminal 23) instantly if the door is forced to open without a valid User Code/Card or pressing Egress Button. The beeps and alarm will last as long as the time set on the timer and it can be stopped at anytime with an User Code/Card in Group 1 before the end of the time.

The Manner of The Door Forced Open Warning:

- The door is forced to open (without using Code/Card or Egress Button) – **Warning & Alarm**
- The door is opened with Code/Card – **No Warning or Alarm**
- The door is opened with Egress Button – **No Warning or Alarm**

(3) VALIDATION

Press # key once. Two-beep confirms the entry

28. DOOR PROPPED-UP WARNING & THE DELAY TIME

-- Location 81

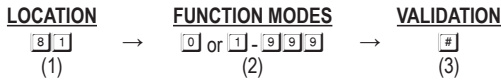

(1) LOCATION

Key in Location **8 1**

(2) FUNCTION MODES FOR DOOR PROPPED-UP WARNING

If somebody opened the door and left it open longer than the allowable delay time, the keypad will generate door propped-up warning **until the door is re-closed**. There is warning beeps from the keypad only but it does not activate the alarm output. This function works with a door position sensing switch equipped on the door.

0 --- Door Propped-up Warning OFF – (Default)

1 - 9 9 9 --- Door Propped-up Warning ON & The Delay Time

The Delay Time can be 1 to 999 seconds. It is the allowed time for door open without starting warning.

(3) VALIDATION

Press **#** key once. Two-beep confirms the entry

INTELLIGENT EGRESS BUTTON – AN UNIQUE FEATURE OF THE KEYPAD

INTRODUCTION

Most of the keypads for access control are just for controlling “Going In” from outside. It is not enough for today’s access control systems. In fact, controlling “Going Out” is also very important in some public passage areas those are not allowed to use locks or digital keypads for stopping of “Going Out” due to safety reasons. Such as hospitals, kindergartens, elderly homes, convenient stores, emergency exits etc.. The wardens, teachers, shopkeepers and the guards are always required to keep an eye on people to prevent unattended leaving, shoplifting, and unauthorized use of the emergency exits.

The Intelligent Egress Button can be programmed to do something to get attention from the person on duty before the door is opened. The button offers programmable egress delay, delay with warning, holding button for the delay, momentary button contact with warning for the delay and even gives alarm when a controlled door is opened.

Locations 90 and 91 are the places for setting the desired functions for the Egress Button.

The functions programmed to the Egress Button do not affect the normal operation of the keypad. The operation of the keypad with Code or Card is always in the first priority to give instant action to the output relay 1 for door strike.

It is **NOT** required to program the Egress Button with the special function in normal use. Just leave it on its default values.

WHERE AND WHY “GOING OUT” NEEDS ATTENTION

Examples for some areas may need an Intelligent Egress Button:

Hospital:

Some of the patients are not allowed to leave the ward without doctor's permission. An egress button with exit delay and warning beeps will help the nurse or warden to get attention to the door when the egress button is pressed. Further setting of the egress button with holding contact delay even gives higher level of security to a controlled door.

Kindergarten:

Young children are always active. Some of them may be willing to go out to explore their ways of playing. For safety reason, teachers have to watch all of them in the attended area. Leaving school alone without the companion of parents or teacher is dangerous to young children. An egress button with delay and warning beeps will be helpful to prevent the children trying to go out without getting the attention of the teacher.

Elderly Home:

The elderly needs constant attention and care. Some old people have poor memory. They may forget the way to come back if they leave home alone. An egress button with delay and warning beep will easily get the attention of the warden before the door is open.

Convenient Store:

Most of the convenient stores have just only one or two shopkeepers on duty. They are usually the cashier. Shoplifting may easily happen while the shopkeeper is busily serving customers at the cashier desk. A holding contact egress button with delay and warning beeps may help to stop most of the shoplifting. As the thief knows that he is gotten attention by the shopkeeper before the door is open.

High Traffic Passage:

A short buffer time may be necessary for opening a door outward after pressing the egress button for those exits open to a high traffic passage. An egress button with short delay and warning beeps helps the user to pay attention to the people passing by to prevent hitting them when the door is pushed outward.

Emergency Exit:

Emergency Exit is not open to the public for daily use. It is for emergency case only. It is usually closed and watched by guards. The egress button of this keypad can be programmed to offer exit delay with warning beeps and even gives alarm output to trigger an alarm system when the door is forced to open or the door is open after the exit delay expired. It is an useful tool to get attention of the person on duty.



Do not enable Egress Delay if instant door open for leaving is the main concern in your area.

Make sure the Egress Delay does not affect the safety in your service area before enabling the function in Location 90.

The default setting of the system is NO DELAY.

29. EGRESS DELAY, WARNING AND ALARM -- Location 90



(1) LOCATION

Key in Location

9	0
---	---

(2) CONFIGURATIONS OF THE EGRESS WARNING AND ALARM

Key in the number to enable 1 of the 6 configurations described below:

| | |---| | 1 | |---| --- Momentary Contact Mode without Warning -- (Default)

- Press the Button once. No warning or alarm is given during Egress Delay.
- Good for silent area. The people have to wait for the door open until the delay time reaches.

| | |---| | 2 | |---| --- Momentary Contact Mode with Warning Beep

- Press the Button once. The system gives Warning Beeps during the Egress Delay.
- Good for the place required attention. The keypad beeps during the people are waiting for the door open.

| | |---| | 3 | |---| --- Momentary Contact Mode with Warning Beep & Alarm

- Press the Button once. The system gives Warning Beeps and also activates its Alarm O/P during the Egress Delay
- Good for door for the authorized people only. The keypad beeps and report alarm to a security system during the people are waiting for the door open.
- This is usually an "Emergency Exit". The door can be opened with the Keypad without triggering of the Buzzer and Alarm Output.

| | |---| | 4 | |---| --- Holding Contact Mode without Warning

- Press and hold the Button. No warning or alarm is given during the Egress Delay.
- Good for the silent area. The people require to press & hold the button until the delay time reaches for the door open.

| | |---| | 5 | |---| --- Holding Contact Mode with Warning Beep

- Press and hold the Button. The system gives Warning Beeps during Egress Delay.
- Good for the place required attention. The keypad beeps while the button is kept pressed during the people are waiting for the door open.

| | |---| | 6 | |---| --- Holding Contact Mode with Warning Beep & Alarm

- Press and hold the Button. The system gives Warning Beeps and also activates its Alarm O/P during Egress Delay.
- This is usually an "Emergency Exit". The door can be opened with the Keypad without triggering of the Warning and Alarm.

(3) EGRESS DELAY TIMER

0 --- No Delay – (Default)

Output 1 activates instantly (the door is released instantly) when the Egress Button is pressed.

1 – 99 --- Egress Delay Timing

Put a number of 1 to 99 into the box to enable the Egress Delay. The number is the time in second, which starts to count when the Egress Button is pressed. Output 1 activates (the door is released) when the delay time reaches.

- **Momentary Contact** -- The Egress Delay starts to count when the egress button is momentarily pressed. Output 1 activates automatically (door is released) when the delay time reaches.
- **Holding Contact** -- The user **MUST** hold the egress button in contact for the whole period of the Egress Delay time until Output 1 activates. If the egress button is released before the end of the Egress Delay, the timer will stop to count and reset.

For safety, it is necessary to put a **sticker next to the egress button** telling how to open the door if "Holding Contact" is enabled.

Example: A sticker for an egress button that is programmed with "Holding Contact" of 5 seconds.

Press & Hold The Button 5 Seconds Minimum Until The Door Is Open

- The Egress Delay does not affect the operation of the User Codes/Cards for Output 1. The User Codes/Cards always give **INSTANT** action.

(4) VALIDATION

Press [#] key once. Two-beep confirms the entry

EXAMPLES:

Example 1: Set Egress Button in Momentary contact of 5 seconds with delay & warning beep

9 0 2 5 #
(a) (b) (c) (d)

(a) Egress function programming, (b) Momentary contact with warning, (c) Delay time of 5 seconds to release door, (d) Entry confirmation

Example 2: Set Egress Button in Holding contact of 10 seconds with warning beep

9 0 5 1 0 #
(a) (b) (c) (d)

(a) Egress function programming, (b) Holding contact mode with warning, (c) Holding time of 10 seconds to release door, (d) Entry confirmation

Example 3: Set Egress Button in Momentary contact without delay (This is the default setting)

9 0 1 0 #
(a) (b) (c) (d)

(a) Egress function programming, (b) Momentary contact without delay, (c) Release door instantly, (d) Entry confirmation

30. DOOR OPENING ALARM & TIMER -- Location 91

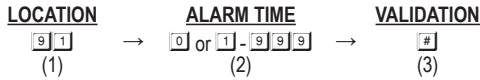

(1) LOCATION

Key in Location 9 1

(2) ALARM & TIMING OF DOOR OPENING

0 --- No Alarm – (Default)

The Alarm Output is disabled

1 - 9 9 9 --- Alarm Timer

The Door Open Alarm operates the Alarm Output (Terminal 23) only. It is mainly prepared to trigger an optional alarm system. Put a Timing Figure of 1 to 999 into the box to enable the function of Door Opening Alarm. The figure is the time in second of the alarm duration, which starts to count after the door is opened and it resets automatically when the time reaches.

The alarm can be stopped with the User Codes/Cards or the Super User Code for Output 1 at any time before the end of the alarm time.

→ The Door Opening Alarm is designed to protect the emergency exit door from use by the un-authorized person. The alarm occurs when the door is opened or forced to open. However, Alarm will not happen if the door is opened with a valid User Code or Card.

This function works with a door position sensing switch equipped on the door.

The Manner of The Door Opening Alarm:

- The door is forced to open without using Code/Card – **Alarm**
- The door is opened with Egress Button – **Alarm**
- The door is opened with Code/Card – **No Alarm**

To prevent confusion of the alarm outputs. It is suggested to disable the “Door Forced Open Warning” at Location 80 while “Door Opening Alarm” function is enabled. If both functions at Location 80 and Location 91 are enabled and are set with different timings, the system will combine them and will take the longer one for alarm time.

(3) VALIDATION

Press # key once. Two-beep confirms the entry

31. WIEGAND DATA OUTPUT MODES -- Location 92

→ This feature is only available to the keypads with Wiegand Data Output.

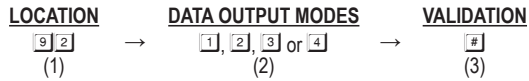

(1) LOCATION

Key in Location 9 2

(2) DATA OUTPUT MODES

1 --- Wiegand Data Output Disabled (Default)

No Wiegand data output

2 --- Wiegand Data Output Enabled -- Mode "A"

The keypad gives Wiegand data output **ONLY** for those cards and codes that have been registered in memory.

3 --- Wiegand Data Output Enabled – Mode "B"

- The keypad gives Wiegand data output for **ALL** the cards and codes that are read; no matter they are registered or not registered in memory.
- This mode makes the keypad to work as an independent keypad or as a server of a split-decoded keypad for door lock actuation; and at the same time serves optional controller that utilizes the Wiegand data for different jobs.
- The keypad discriminates the registered and non-registered cards and codes with different beeps when it sends out the Wiegand data; successful beeps for the registered cards and codes and five beeps for the non-registers.

The keypad follows the lock-up setting at Location 60

4 --- Wiegand Data Output Enabled – Mode "C"

This is the **Reader Mode** of the keypad. It gives Wiegand data output for **ALL** the cards and codes that are read; no matter they are registered or not registered in memory.

- This mode makes the keypad to work as an independent keypad or as a server of a split-decoded keypad for door lock actuation and at the same time serves optional controller that utilizes Wiegand data for different jobs.
- The keypad **ALWAYS** gives successful beeps when it sends out the Wiegand data after reading a card or code.
- The keypad does not follow the lock-up setting at Location 60 and disables it automatically in Mode "C" to make it a reader to un-limitedly accept reading of cards and codes.

(3) VALIDATION

Press # key once. Two-beep confirms the entry

32. WIEGAND DATA OUTPUT FORMAT -- Location 93

→ This features is only available to the keypads with Wiegand Data Output.

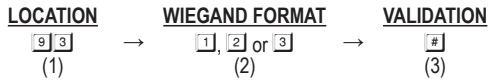

(1) LOCATION

Key in Location

(2) WIEGAND FORMAT FOR EM CARD & USER CODE

The Wiegand data output is programmable for 26-bit, 34-bit or 37-bit standard format.

26-Bit Wiegand Data Output

- Bit 1: Even Parity Bit (bit 2 – bit 13)
- Bit 2 – Bit 25: 24 Bit ID Number
- Bit 26: Odd Parity Bit (bit 14 – bit 25)

34-Bit Wiegand Data Output

- Bit 1: Even Parity Bit (bit 2 – bit 17)
- Bit 2 – Bit 33: 32 Bit ID Number
- Bit 34: Odd Parity Bit (bit 18– bit 33)

37-Bit Wiegand Data Output

- Bit 1: Even Parity Bit (bit 2 – bit 19)
- Bit 2 – Bit 36: 35 Bit ID Number
- Bit 37: Odd Parity Bit (bit 19– bit 36)

(3) VALIDATION

Press key once. Two-beep confirms the entry

33. OPERATION MODES -- Location 94

The keypad is programmable for keypad mode to work stand-alone for door control directly or for server mode to work with a split-decoder for high security access control.

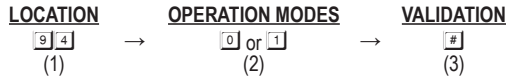

(1) LOCATION

Key in Location 9 4

(2) OPERATION MODES

0 – Keypad Mode (Default)

Keypad Mode sets the keypad for stand-alone operation to provide its available functions. It is compatible with the auxiliary readers/keypads for multi-station expansion.

1 – Server Mode

Server Mode sets the keypad to compatible with both the decoder for split-decoded operation and the auxiliary readers/keypads for multi-station expansion. A split decoded keypad system uses the keypad(s) for human interface outside and the internal decoder for door lock control to prevent sabotage.

(3) VALIDATION

Press # key once. Two-beep confirms the entry

→ The DK-2800 MK-II keypads are set in “KEYPAD MODE” in default. It is necessary to set it to “SERVER MODE” while the keypad is in Split-Decoded operation. Here are the code entries of setting the keypad into “SERVER MODE”

9 4 1 #

34. CLOSE PROGRAMMING MODE -- * *

Always close programming mode with ** to set system back to normal Operation after programming.

The  button is equivalent to the  button in the keypad with bell button.

VALIDATION



* * ----- System is back to normal operation mode

35. PROGRAMMING MAKE SIMPLE – FOR GENERAL USERS

Split-decoded keypad is multi purpose keypad. It has many functions for user's selection. For those general users taking the keypad for door strike only, most of the features can be kept in their Default values. Only the User Codes / Cards and a private Master Code are required to program.







The keypad accepts **1) Card only, 2) Code only, 3) Card + Code or 4) Card + Common User Code** to operate its outputs.

PROGRAMMING

→ The  button is equivalent to the  button in some of the keypads.







Wait 1 minute until the end of power up delay, or keyin  to stop the power-up delay instantly and set the keypad to normal operation mode.

1) Set System in Programming Mode with The Factory Set Master Code 0 0 0 0

  ---- 2 beeps, system is in Programming Mode







→ If the Master Code is forgotten, use the DAP Code to set the system into programming mode. See DAP CODE 2828 for the details.

2) Change The Factory Set Master Code to Owner's Private Master Code for Security Reason

   ---- 2 beeps, 3 2 8 9 is a Master Code for example here only.











It replaces the old master code 0000.

3) Record an "EM Card" to Operate The Output 1 for Door Open

 (a)  (b)  (c)  (d)  (e)

- (a) 10 = Programming Location for Output 1
- (b) 1 = Programming option for EM Card only
- (c) 001 = One of the 1,000 User IDs for the User Code/Card from 000-999
- (d) Read Card = Put the Card close to the card reader
- (e) # = Confirm the card is read, 2 beeps

4) Set an "User Code" to Operate The Output 1 for Door Open

 (a)  (b)  (c)  (d)  (e)

- (a) 10 = Programming Location for Output 1
- (b) 2 = Programming option for User Code only
- (c) 002 = One of the 1,000 User IDs for the User Code/Card from 000-999
- (d) 8321 = The User Code for door open. It is for example here only
- (e) # = Confirm the User Code, 2 beeps

5) Record an "EM Card + User Code" to Operate The Output 1 for Door Open

- (a) 10 = Programming Location for Output 1
- (b) 3 = Programming option for EM Card + User Code. (The User Code can be repeated use or proprietary)
- (c) 003 = One of the 1,000 User IDs for the User Code/Card from 000-999
- (d) Read Card = Put the Card close to the card reader
- (e) 6123 = The User Code to be used with the EM Card. It is for example here only.
- (f) # = Confirm the Card+Code is stored, 2 beeps

6) Record an "EM Card + Common User Code" to Operate The Output 1 for Door Open

- (a) 10 = Programming Location for Output 1
- (b) 4 = Programming option for EM Card + Common User Code
- (c) 004 = One of the 1,000 User IDs for the User Code/Card from 000-999
- (d) Read Card = Put the Card close to the card reader
- (e) # = Confirm the card is read, 2 beeps, the Common User Code goes to this User ID automatically automatically
- (f) A Common User Code (for example: 1 3 5 7) **MUST** be set at the Programming **Location 03 first**. Common code can be used for all the EM Cards in this operation mode. firstM Cards in this

If more User Codes and Cards are required for Output 1, repeat the procedures (3), (4), (5) or (6) above with other User IDs, such as 005, 006, 007 --- 999 etc. Total 1,000 users are allowed. See Programming Location 10 for the details.

7) Close The Programming Mode

---- 2 beeps

The programming mode is closed. The keypad is back to normal operation mode

OPERATION

Open The Door with EM Card

--- 2 beeps, the door is open

Open The Door with User Code

 --- 2 beeps, the door is open

Open The Door with EM CARD + User Code

 --- 2 beeps, the door is open

Open The Door with EM CARD + Common User Code

 --- 2 beeps, the door is open

36. WIEGAND OUTPUT FORMATS FOR ADVANCED KEYPADS

The Timing and Electrical Manner of The Wiegand Data Output

Wiegand is a common medium in the communication between readers and controller in access control. The Wiegand data from the keypad unit provides a level of compatibility for readers and controller that can be used by consultants in custom project development.

The Wiegand interface uses three wires, one of which is a **Common Ground** and two of which are data transmission wires called **DATA 0** and **DATA 1**. When no data is being sent both DATA 0 and DATA 1 are at high voltage. When a "0" is sent the DATA 0 is at low voltage while the DATA 1 stays at a high voltage. When a "1" is sent DATA 1 is at the low voltage while DATA 0 stays at the high voltage.

The high voltage level in the keypad unit is +5VDC to accommodate for long cable runs (approximate 500 feet) from it to the associated controller typically located in a secure closet.

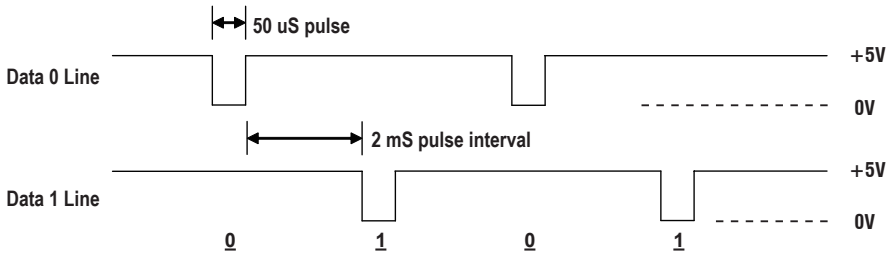

Wiegand Data 26-Bit, 34-Bit or 37-Bit Selection Jumper

The Wiegand data output is programmable to 26-bit, 34-bit or 37-bit standard format for EM Cards and User Codes on Location 93.

26-Bit Wiegand Data Output

Bit 1: Even Parity Bit (bit 2 – bit 13)

Bit 2 – Bit 25: 24 Bit ID Number

Bit 26: Odd Parity Bit (bit 14 – bit 25)

34-Bit Wiegand Data Output

Bit 1: Even Parity Bit (bit 2 – bit 17)

Bit 2 – Bit 33: 32 Bit ID Number

Bit 34: Odd Parity Bit (bit 18 – bit 33)

37-Bit Wiegand Data Output

Bit 1: Even Parity Bit (bit 2 – bit 19)

Bit 2 – Bit 36: 35 Bit ID Number

Bit 37: Odd Parity Bit (bit 20 – bit 36)

37. PROGRAMMING SUMMARY CHART

LOCATION	FUNCTION	ENTRY LIMITS & CODE OPTIONS	CODE ENTRY	FACTORY DEFAULT
0 1	Master Code	4-8 Digits	[0] [1] [READ CARD] [#]	NIL
0 2	Super User Code	4-8 Digits	[0] [2] [SUPER USER CODE] [#]	NIL
0 3	Common User Code for O/P 1	4-8 Digits	[0] [3] [COMMON USER CODE 1] [#]	NIL
0 4	Common User Code for O/P 2		[0] [4] [COMMON USER CODE 2] [#]	NIL
0 5	Common User Code for O/P 3		[0] [5] [COMMON USER CODE 3] [#]	NIL
1 0	User Codes / Cards for O/P 1	CODE 1 - MEDIA: 1---EM Card 2---Private User Code 3---EM Card+Sec User Code 4---EM Card+Com User Code 5---Deletion of User Code	[1] [0] [CODE1] [CODE2] [CODE3] [#]	NIL
2 0	User Codes / Cards for O/P 2	CODE 2 - USER ID: 000-999---Group 1(10) 001-100---Group 2(20) 001-100---Group 3(30)	[2] [0] [CODE1] [CODE2] [CODE3] [#]	NIL
3 0	User Codes / Cards for O/P 3	CODE 3 - USER CODES / Cards: 4-8 Digits / Cards	[3] [0] [CODE1] [CODE2] [CODE3] [#]	NIL
4 0	Visitor Codes	CODE 1 - VISITOR ID: 01-50 CODE 2 - VALID PERIOD: 00---One Time 01-99 Hours CODE 3 - VISITOR CODE: 4-8 Digits	[4] [0] [CODE1] [CODE2] [CODE3] [#]	NIL
4 1	Duress Code for O/P 1	CODE ID - O/P 1: 01-50 CODE ID - O/P 2: 01-10 CODE ID - O/P 3: 01-10 DURESS CODE: 4-8 Digits	[4] [1] [CODE ID] [DURESS CODE] [#]	NIL
4 2	Duress Code for O/P 2		[4] [2] [CODE ID] [DURESS CODE] [#]	NIL
4 3	Duress Code for O/P 3		[4] [3] [CODE ID] [DURESS CODE] [#]	NIL
5 1	O/P Mode for O/P 1	OUTPUT MODE & TIME: 0--- Start / Stop 1---99999 Seconds, Momentary	[5] [1] [O/P MODE & TIME] [#]	5 Seconds
5 2	O/P Mode for O/P 2		[5] [2] [O/P MODE & TIME] [#]	5 Seconds
5 3	O/P Mode for O/P 3		[5] [3] [O/P MODE & TIME] [#]	5 Seconds
5 5	Real-Time-Clock	CURRENT REAL TIME: 00:00-23:59	[5] [5] [CURRENT TIME] [#]	NIL
5 6	Start & Stop Times for Inhibition	START TIME: 00:00-23:59 STOP TIME: 00:00-23:59	[5] [6] [START TIME] [STOP TIME] [#]	NIL

LOCATION	FUNCTION	ENTRY LIMITS & CODE OPTIONS	CODE ENTRY	FACTORY DEFAULT
60	Personal Safety & Lock-Up	LOCK-UP CODE: 1---10 Trial, Lock-Up 60 Sec. 2---10 Trial, Activates Duress 5-10---5-10 Trial, Lock-Up 15 Minutes 00---No Lock-Up	[6] [0] [LOCK-UP CODE] [#]	Code = 1, 10 Trials, Lock-Up 60 Seconds
70	Code Entry Mode	ENTRY MODE: 1---Auto Mode 2---Manual Mode	[7] [0] [ENTRY MODE] [#]	Mode = 2, Manual Mode
71	Pacifier Tone ON-OFF	FUNCTION MODE: 0---OFF 1---ON	[7] [1] [FUNCTION MODE] [#]	Mode = 1, Pacifier Tone ON
72	Output Announcer	FUNCTION MODE: 0---OFF 1---1 Second Long Beep 2---2 Short Beeps	[7] [2] [FUNCTION MODE] [#]	Mode = 1 1 Second Long Beep
73	Standby LED Flashing	FUNCTION MODE: 0---OFF 1---ON	[7] [3] [FUNCTION MODE] [#]	Mode = 1, Flashing ON
80	Door Forced Open Warning & Time	FUNCTION MODE / TIME: 0---OFF 1-999 Seconds	[8] [0] [FUNCTION / TIME] [#]	Mode = 0, Door Forced Open Warning OFF
81	Propped-up Warning & Time		[8] [1] [FUNCTION / TIME] [#]	Mode = 0, Propped-up Warning OFF
90	Egress Delay Warning & Alarm	CODE 1 - FUNCTION MODE: 1---Momentary, No warning 2---Momentary, with warning 3---Momentary, with warning + Alarm 4---Hold Contact, No warning 5---Hold Contact, with warning 6---Hold Contact, with warning + Alarm CODE 2 - DELAY TIME: 0---No Delay 1-99 Seconds	[9] [0] [CODE 1] [CODE 2] [#]	Mode = 1 Momentary, No warning TIME = 0 No Delay
91	Door Opening Alarm & TIMER	ALARM TIME: 0---No Alarm 1-999 Seconds	[9] [1] [ALARM TIME] [#]	Time = 0, No Alarm

LOCATION	FUNCTION	ENTRY LIMITS & CODE OPTIONS	CODE ENTRY	FACTORY DEFAULT
*9 2	Wiegand Data Output Mode	DATA OUTPUT MODE 1 --- Wiegand Data Output Disabled 2 --- Wiegand Data Output Enabled -- Mode "A" 3 --- Wiegand Data Output Enabled -- Mode "B" 4 --- Wiegand Data Output Enabled -- Mode "C"	[9] [2] [DATA OUTPUT MODE] [#]	Mode = 1 Disabled
*9 3	Wiegand Data Output Format Mode	DATA OUTPUT MODE 1 --- 26-Bit Wiegand Data 2 --- 34-Bit Wiegand Data 3 --- 37-Bit Wiegand Data	[9] [3] [WIEGAND FORMAT] [#]	Format = 1 26-Bit
9 4	Operation Mode	FUNCTION MODE: 0 --- Keypad Mode 1 --- Server Mode	[9] [4] [FUNCTION MODE] [#]	Mode = 0 Keypad Mode

* Locations 92 and 93 are available for those keypads with Wiegand Data Output.

FUNCTION MODE	FUNCTION	CODE ENTRY	RESULTS
0 0 0 0	Factory Set Master Code for User to set system in programming Mode at the first time. THIS IS NOT A PERMANENT SYSTEM CODE & IT IS CHANGED IF A NEW MASTER CODE IS PROGRAMMED.	[0] [0] [0] [0] [*] [*] OR [NEW MASTER CODE] [*] [*]	System in Programming Mode
9 9 9 9	REFRESH CODE -- Refresh the system and set all its function back to default values.	[9] [9] [9] [9] [#]	All programmed data are cleared and back to the default values except the Master Code
2 8 2 8	DAP CODE -- Direct access to programming mode. Valid only in the power-up delay period	[2] [8] [2] [8] [#]	System in Programming Mode
0 9 9 9	USER Codes / Cards whole group clearing Code for the selected Location LOCATIONS: 10--- User Group 1 20--- User Group 2 30--- User Group 3 40--- Vistor Group 41--- Duress Group 1 42--- Duress Group 2 43--- Duress Group 3	[LOCATION NO.] [0] [9] [9] [9] [#]	Whole group of users in the selected location are cleared
**	Exit Programming Code	[*] [*]	The system back to normal operation after programming

38. APPLICATION EXAMPLES

a) BASIC WIRINGS OF A SPLIT-DECODED ACCESS CONTROL DOOR LOCK

Description

Split-decoded keypad provides overall higher security than the stand alone keypad. It consists of a server keypad unit installing outside for human interface and a decoder unit installing inside the house for all the input / output wire installations. The two units are linking up with the Data I/O bus. The server keypad manages the data while the decoder operates the door lock or appliance according to the commands from the server keypad. This approach prevents the door lock or the controlled appliance be operated due to sabotage at the external keypad.

System Connection

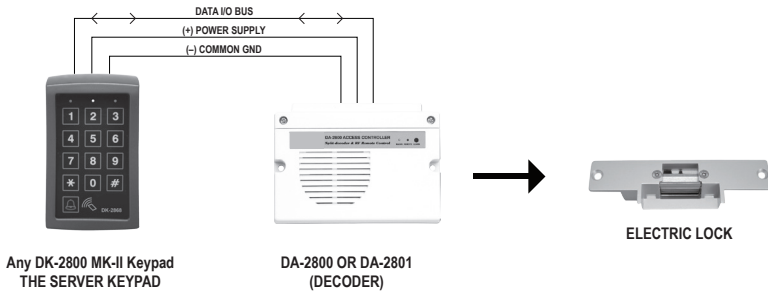

System Connection

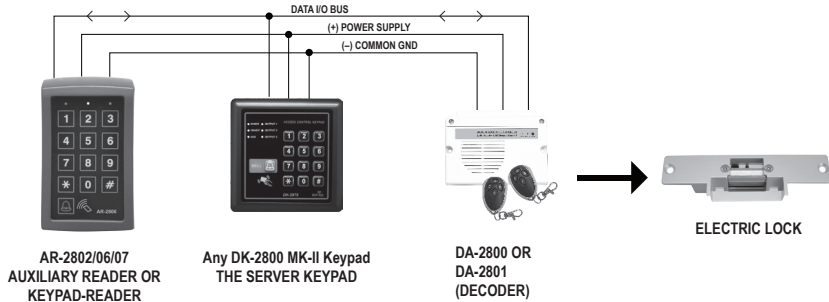

Wiring Diagram

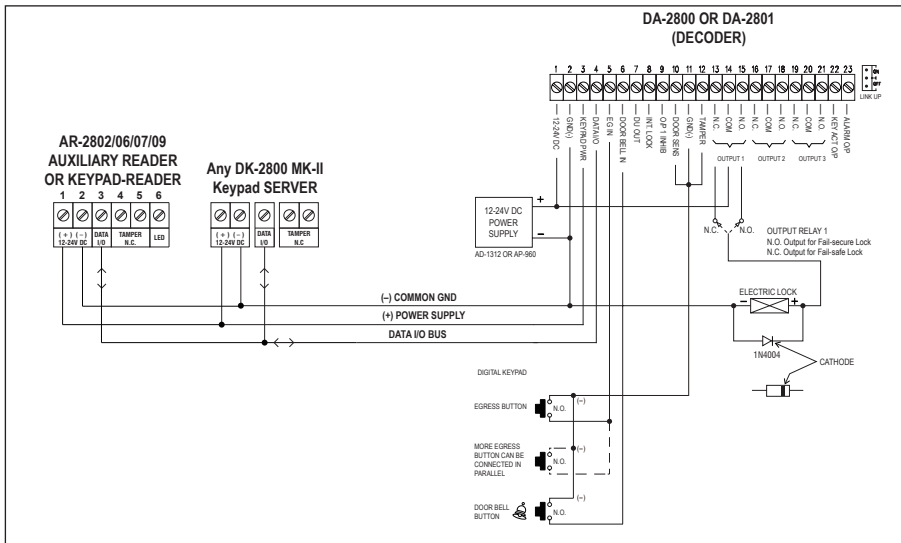

c) A DUAL KEYPAD SPLIT-DECODED ACCESS CONTROL INTER-LOCK SYSTEM

Description

The decoder unit (DA-2800 or DA-2801) provides all the logic circuits for inter-lock connection. An inter-lock system needs two door controllers. Simply make a pair of cross wire connection on "Output 1 Inhibit" (terminal 9) and "Inter-lock" (terminal 8) of the two decoders to accomplish the inter-lock functions. This approach is for the important place requiring high security protection in access control. See page 13-14 Terminals 8 & 9 for more information about inter-lock.

System Connection

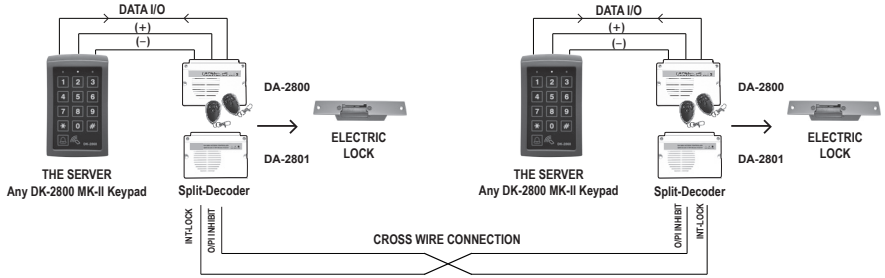

Wiring Diagram

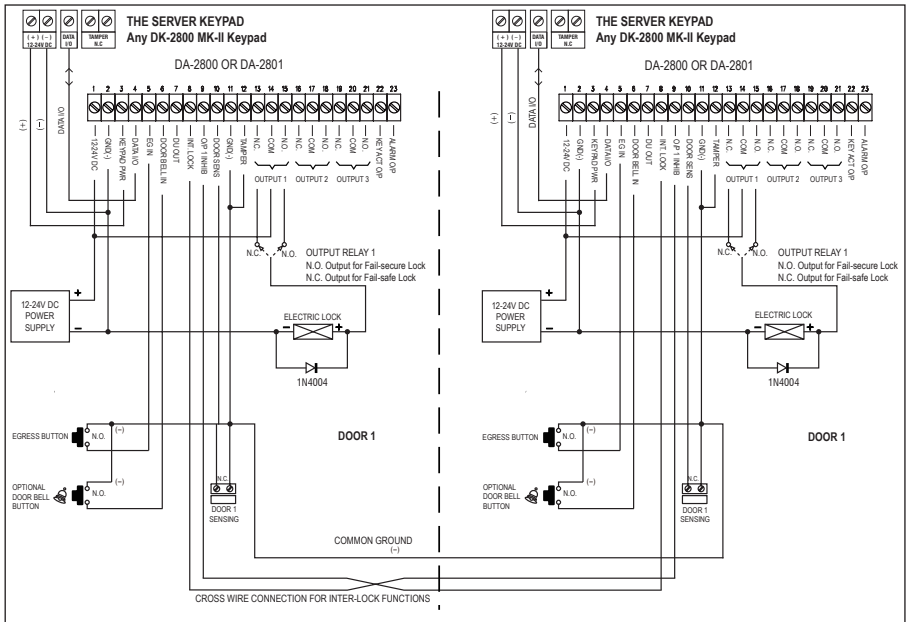

39. APPLICATION HINTS FOR THE AUXILIARY TERMINALS

(A-1) TAMPER N.C.

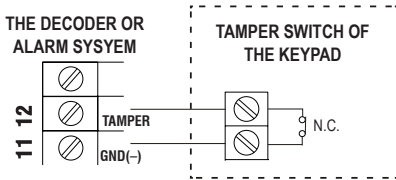

The tamper switch is Normally Closed while the keypad is secured on gang box. It is open when the keypad is removed from the gang box. To prevent sabotage, connect these terminals in series with a 24 hour N.C. protection zone of an alarm system or the temper input terminal of the decoder.

(A-2) TAMPER N.C.

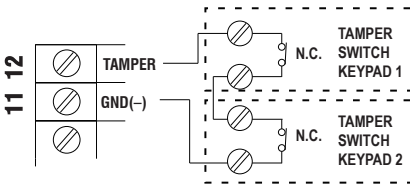

System consisting more than one keypad, such as multi-station, it consists auxiliary keypad-reader and server keypad. It is required to connect their tamper switches in series to the tamper input terminal of the decoder if tamper-proof is required.

(B) DOOR SENS

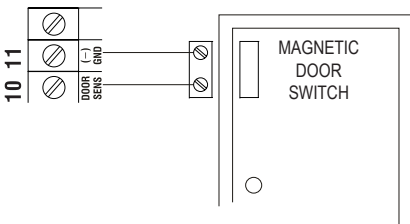

With the help of a Normally Closed door position sensor (usually a magnetic door switch) on the door to set up the following functions:

- **Door Auto Relock** -- The system will immediately relock the door after a valid access has been gained to prevent "tailgate" entries.
- **Door Forced-open Alarm** -- The keypad will generate alarm instantly if the door is forced to open. Enable the function at Location 80.
- **Door Propped-up Alarm** -- The keypad will generate alarm if the door is left open longer than the pre-set delay time. Enable the function at Location 81.
- **Inter-lock Control** -- When the door is open, the interlock output of the keypad will give a (-) command to stop the other keypad in an inter-lock system.
- **Door Opening Alarm** -- Door Opening Alarm is designed for the emergency door only. It is always given when the door is opened unless a valid user code or card is used prior to the door is opened. Enable the function at Location 91.

(C) ALARM OUTPUT

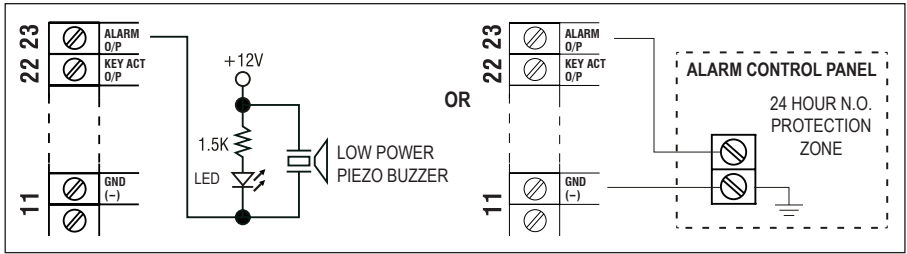

The Alarm Output switches to (-) ground in door forced to open or the door open after Egress Delay. You may use it to turn ON an LED lamp and/ or a small buzzer to notify a guard; or connect it to a 24 hour Normally Open protection zone of an alarm system. See Location 80 and Location 91 for more information about these functions.

- Only one connection option is recommended. Make sure that the sink current does not exceed the maximum rating of 100mA.

(D) KEY ACTIVE -- OUTPUT

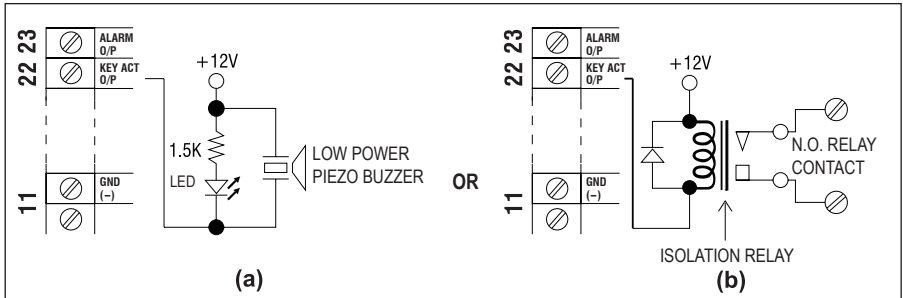

The Key Active Output switches to (-) ground for 10 seconds whenever a key is touched. You may use it to turn ON an LED lamp and /or a small buzzer to notify a guard; or to energize a relay to switch ON lights or trigger an CCTV Camera to start recording.

- Make sure that the relay for switching ON lights has high enough isolation between high voltage and low voltage to prevent damage of the keypad.
- Only one connection option is recommended. Make sure the sink current does not exceed the maximum rating of 100mA.
- External power supply and isolation relay are strictly necessary in driving high power device, such as lights.

(E) DURESS OUTPUT

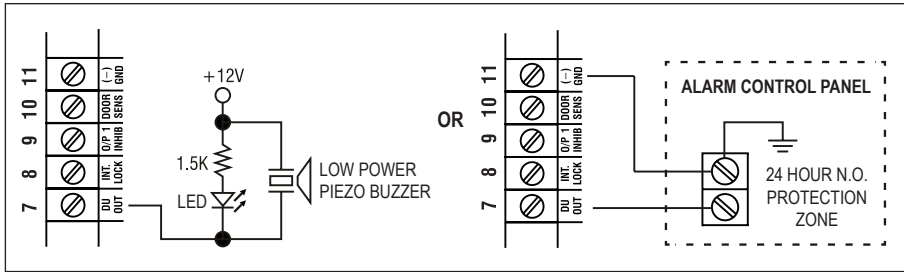

The Duress Output switches to (-) ground when duress code is entered. You may use it to turn ON an LED lamp and/or a small buzzer to notify a guard; or connect it to a 24 hour Normally Open protection zone of an alarm system.

- Only one connection option is recommended. Make sure that the sink current does not exceed the maximum rating of 100mA.

40. THE OPTIONAL AUXILIARY READERS & KEYPADS

The split-decoded keypad is expandable to be a Multi-station System with its Data I/O Bus for the connection of the optional auxiliary keypad(s). The wiring is very simple. Just connect all the devices in parallel with the Data I/O Bus. The server keypad manages the data among of them.

A Multi-station System provides higher security and user convenience to operate an electric lock at different locations. Such as a dual keypad system for area needs controlling of going in and going out with user codes or EM cards.

The application example 2 shows the connection of auxiliary keypad to the server keypad.

The version "A" auxiliary reader keypads are available, which also provide Wiegand and RS-232 data outputs.

Please contact your local agent for these optional devices.

AR-2802	AR-2806	AR-2807
Aux. Reader	Aux. Reader-Keypad	Aux. Reader-Keypad

Connection Terminal

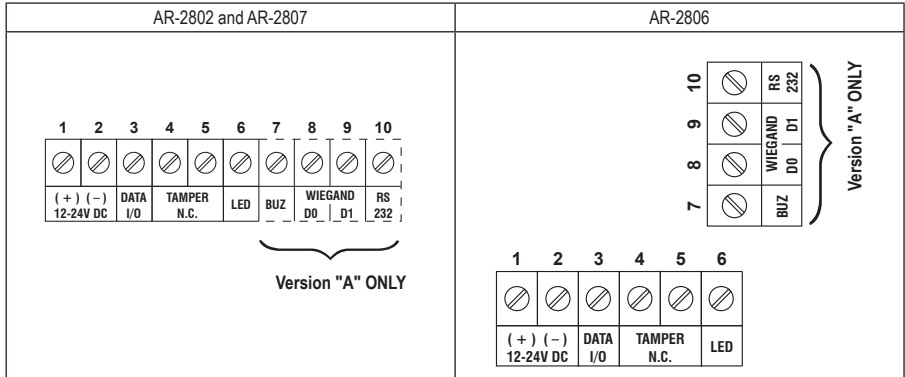

41. AUXILIARY INFORMATION

- **DRY CONTACT**

A dry contact means that no electricity is connected to it. It is prepared for free connections. The Relay Output contacts provided in this keypad system are dry contacts.

- **N.C.**

Normally Closed, the contact is closed circuit at normal status. It is open circuit when active.

- **N.O.**

Normally Open, the contact is open circuit at normal status. It is closed circuit when active.

- **TRANSISTOR OPEN COLLECTOR OUTPUT**

An open collector output is equivalent to a Normally Open (N.O.) contact referring to ground similar to a relay contact referring to ground. The transistor is normally OFF, and its output switches to ground (-) when active. The open collector can only provide switching function for small power but it is usually good enough for controlling of an alarm system. The Duress, Inter-lock and Key Active/Alarm Outputs of the keypad are open collector outputs.

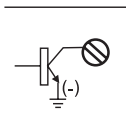

OPEN COLLECTOR OUTPUT ----
Output switches to ground when activated

EQUIVALENT

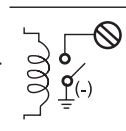

N.O. CONTACT OUTPUT ----
Output switches to ground when activated

42. TECHNICAL DATA

→ For technical data please refer to Part 1 of these operating instructions.

GB This is a publication by Conrad Electronic SE, Klaus-Conrad-Str. 1, D-92240 Hirschau (www.conrad.com).

All rights including translation reserved. Reproduction by any method, e.g. photocopy, microfilming, or the capture in electronic data processing systems require the prior written approval by the editor. Reprinting, also in part, is prohibited. This publication represent the technical status at the time of printing.

Copyright 2018 by Conrad Electronic SE.