

Datasheet

1. Scope:

This specification for approval relates to Metal Film Fixed Resistors

2. Type designation:

The type designation shall be in the following form :

All part numbers in the coding below start with "TC-" and end with "203"

(Ex.)	<u>MF</u>	<u>1/4W</u>	<u>F</u>	<u>100Ω</u>
	Type	Power Rating	Resistance Tolerance	Nominal Resistance

3. Ratings:

Ratings shall be shown in the table 1.

Table 1

Type	MF
Rated Power at 70°C	1/4W (0.25W)
Max. Working Voltage	250 V
Max. Overload Voltage	500 V
Dielectric Withstanding Voltage	500 V
Rated Ambient Temp.	70 °C
Operating Temp. Range	-55°C ~ +155°C
Resistance Tolerance	± 1%
Resistance Range	1Ω ~ 10MΩ

3.1 Power rating:

Resistors shall have a power rating based on continuous full load operation at an ambient temperature of 70 °C. For temperature in excess of 70 °C , the load shall be derated as shown in the figure 1.

3.2 Voltage rating:

Resistors shall have a rated direct-current (DC) continuous working voltage or an approximate sine-wave root-mean-square (RMS) alternating-current (AC) continuous working voltage at commercial-line frequency and waveform corresponding to the power rating , as determined from the following formula :

$$RCWV = \sqrt{P \times R}$$

Were : RCWV = Rated DC or RMS AC continuous working voltage at commercial-line frequency and waveform (volt)

P = Power Rating (watt)

R = Nominal Resistance (ohm)

Metal Film Fixed Resistors

In no case shall the rated DC or RMS AC continuous working voltage be greater than the applicable maximum value

Figure 1.

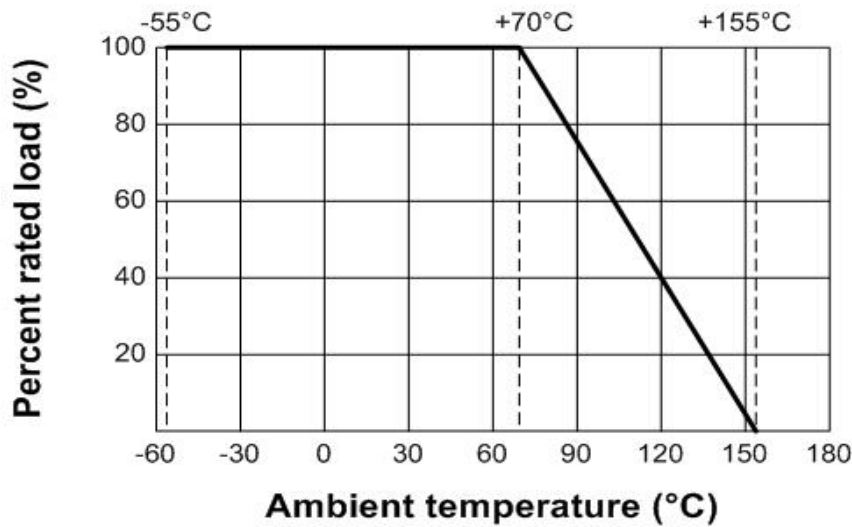

3.3 Nominal resistance :

Effective figures of nominal resistance shall be in accordance with E-96 series, and resistance tolerance shall be shown by table 1.

4. Construction :

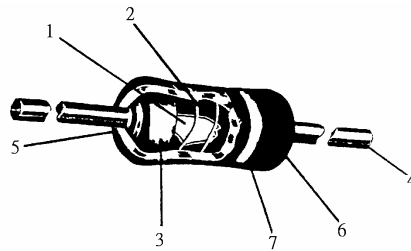

No.	Name	Material
1	Basic Body	Rod Type Ceramics
2	Resistance Film	Metal Film
3	End Cap	Steel (Tin plated iron surface)
4	Lead Wire	Annealed copper wire coated with tin
5	Joint	By Welding
6	Coating	Insulated epoxy resin (Color : Sky blue)
7	Color Code	Epoxy Resin

Datasheet

Metal Film Fixed Resistors		
5. Characteristics :		
Characteristics	Limits	Test Methods (JIS C 5201-1)
DC. resistance	Must be within the specified tolerance	The limit of error of measuring apparatus shall not exceed allowable range or 1% of resistance tolerance (Sub-clause 4.5)
Insulation resistance	Insulation resistance is 10,000 MΩ Min	Resistors shall be clamped in the trough of a 90° metallic V-block or foil method use a metal foil shall be wrapped closely around the body of the resistor. After that shall be tested at DC potential respectively specified in the above list for 60 +10/-0 secs. (Sub-clause 4.6)
Dielectric withstanding voltage	No evidence of flashover mechanical damage, arcing or insulation break down	Resistors shall be clamped in the trough of a 90° metallic V-block or foil method use a metal foil shall be wrapped closely around the body of the resistor. After that shall be tested at AC potential respectively specified in the table 1. for 60 +10/-0 secs. (Sub-clause 4.7)

Datasheet

Metal Film Fixed Resistors																	
Characteristics	Limits	Test Methods (JIS C 5201-1)															
Soldering temp. reference	Electrical characteristics shall be satisfied. Without distinct deformation in appearance. (95 % coverage Min.)	<p>The leads immersed into solder bath to 3.2 to 4.8 mm. from the body. Permanent resistance change shall be checked.</p> <p><u>Wave soldering condition: (2 cycles Max.)</u></p> <p>Pre-heat : 100 ~ 120 °C, 30 ± 5 sec. Suggestion solder temp.: 235 ~ 255 °C, 10 sec. (Max.) Peak temp.: 260 °C</p> <p><u>Hand soldering condition:</u></p> <p>Hand Soldering bit temp. : 380 ± 10 °C Dwell time in solder : 3 +1/-0 sec.</p>															
Resistance to soldering heat	Resistance change rate is ± (1% + 0.05 Ω) Max. with no evidence of mechanical damage	Permanent resistance change when leads immersed to 3.2 to 4.8 mm from the body in 350°C ± 10 °C solder for 3 ± 0.5 seconds (Sub-clause 4.18)															
Temperature cycling	Resistance change rate is ± (1% + 0.05 Ω) Max. with no evidence of mechanical damage	Resistance change after continuous 5 cycles for duty shown below:															
		<table border="1"> <thead> <tr> <th>Step</th> <th>Temperature</th> <th>Time</th> </tr> </thead> <tbody> <tr> <td>1</td> <td>-55°C ± 3°C</td> <td>30 mins</td> </tr> <tr> <td>2</td> <td>Room temp.</td> <td>10~15 mins</td> </tr> <tr> <td>3</td> <td>+155°C ± 2°C</td> <td>30 mins</td> </tr> <tr> <td>4</td> <td>Room temp.</td> <td>10~15 mins</td> </tr> </tbody> </table>	Step	Temperature	Time	1	-55°C ± 3°C	30 mins	2	Room temp.	10~15 mins	3	+155°C ± 2°C	30 mins	4	Room temp.	10~15 mins
		Step	Temperature	Time													
		1	-55°C ± 3°C	30 mins													
		2	Room temp.	10~15 mins													
3	+155°C ± 2°C	30 mins															
4	Room temp.	10~15 mins															
(Sub-clause 4.19)																	

Metal Film Fixed Resistors

6. Dimension :

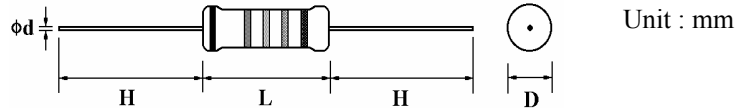

Type	Power Rating	D (Max.)	L (Max.)	d ± 0.05	H ± 3
MF	1/4W	2.5 mm	6.8 mm	0.54 mm	28 mm

Painting method:

Welding point, terminal and lead wire, is permissible to be exposed without the outer coated cover. The extent should be within 1/2 of the arc angle.

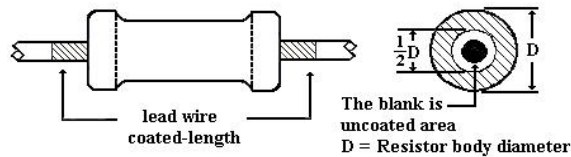

7. Marking :

7.1 Resistor :

Resistors shall be marked with color coding
colors shall be in accordance with JIS C 0802

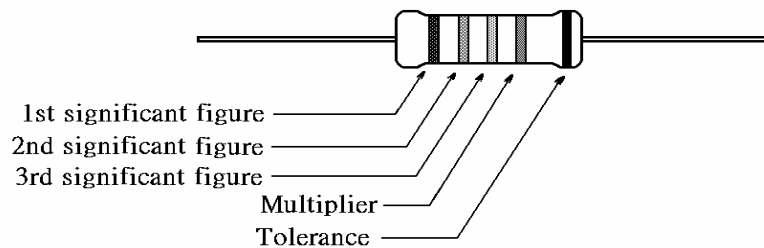

7.2 Label :

Label shall be marked with following items: Example :

- (1) Type and style
- (2) Nominal resistance
- (3) Resistance tolerance
- (4) Quantity
- (5) Lot number
- (6) PPM

Metal Film Fixed Resistors	
Watt : 1/4W	Val : 100E
Q'TY : 2,000	Tol : 1%
Lot : 319022	PPM : 50
Pb-Free	

Metal Film Fixed Resistors

8. Packing specification :

8.1 Taping dimension :

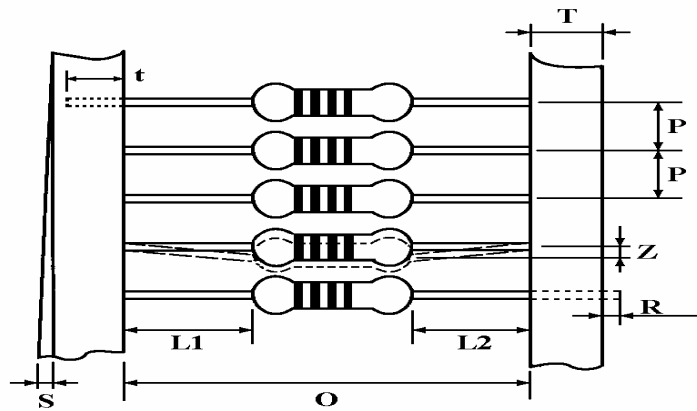

Dimensions (mm)

Type	Style	O	P	L1-L2	T	Z	R	t	S
MF-25	PT-52	52 ± 1	5 ± 0.3	1 Max.	6 ± 1	1 Max.	0	4 ± 1	0.5 Max.

8.2 Tape in box packing :

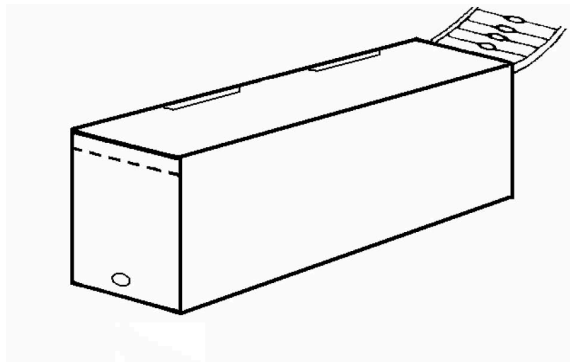

Bandoliers may also be contained in a cardboard box ("Ammopack")

Part Number System

Explanation of Part Number System (Metal Film Fixed Resistors)

All part numbers in the coding below start with "TC-" and end with "203"

1	2	3	4	5	6	7	8	9	10	11	12	13	14
M	F	0	W	4	F	F	1	0	0	0	A	2	0

Product Type:

MF = Metal Film

Special Feature:

0 = Standard
F = Non-Flame
I = Non-Inductive

Wattage:

Normal size:

W8 = 1/8W
W4 = 1/4W
W2 = 1/2W
1W = 1W
2W = 2W
3W = 3W

Small size:

S4 = 1/4W-S
S2 = 1/2W-S
06 = 0.6W-S
M7 = 0.75W-S
1S = 1W-S
2S = 2W-S
3S = 3W-S

Extra Small size:

U2 = 1/2W-SS
04 = 0.4W-SS

Tolerance:

B = ± 0.1%
C = ± 0.25%
D = ± 0.5%
F = ± 1%
G = ± 2%
J = ± 5%

Resistance Value:

E-24 series: the 1st digit is "0", the 2nd & 3rd digits are for the significant figures of the resistance and the 4th indicate the number of zeros following:
"J" ~ 0.1, "K" ~ 0.01

Ex.: 4.7Ω ~ 47J, 4.7KΩ ~ 472

E--96 Series: the 1st to 3rd digits are significant figures of resistance and the fourth one denotes number of zeros following:

Ex.: 1.33KΩ = 1331

Packing Quantity:

1 = 1,000pcs
2 = 2,000pcs
4 = 4,000pcs
5 = 5,000pcs
A = 500pcs
B = 2,500pcs
0 = for Bulk/Box

Packing Type:

A = Tape/Box
T = Tape/Reel
B = Bulk/Box
P = Tape/Box of PT-26mm

PPM requirement:

B = ± 15PPM
C = ± 25PPM
F = ± 50PPM
G = ± 100PPM
J = ± 200PPM

Addition Information:

P = Panasert type
1 = Avisert type 1
2 = Avisert type 2
3 = Avisert type 3
0 = PT-52mm, PT-26mm
8 = PT-58mm
9 = PT-64mm
7 = Lead wire(H) 38mm

Sample:

MF 1/4W +/- 1% 50ppm 100Ω T/B 2,000 → MF0W4FF1000A20

Metal Film Fixed Resistors

Environment Related Substance

This product complies to EU RoHS directive, EU PAHs directive, EU PFOS directive and Halogen free.

Ozone layer depleting substances.

Ozone depleting substances are not used in our manufacturing process of this product.

This product is not manufactured using Chloro fluorocarbons (CFCs), Hydrochlorofluorocarbons (HCFCs), Hydrobromofluorocarbons (HBFCs) or other ozone depleting substances in any phase of the manufacturing process.

Storage Condition

The performance of these products, including the solderability, is guaranteed for a year from the date of arrival at your company, provided that they remain packed as they were when delivered and stored at a temperature of $25^{\circ}\text{C} \pm 5^{\circ}\text{C}$ and a relative humidity of $60\%\text{RH} \pm 10\%\text{RH}$

Even within the above guarantee periods, do not store these products in the following conditions. Otherwise, their electrical performance and/or solderability may be deteriorated, and the packaging materials (e.g. taping materials) may be deformed or deteriorated, resulting in mounting failures.

1. In salty air or in air with a high concentration of corrosive gas, such as Cl_2 , H_2S , NH_3 , SO_2 , or NO_2
2. In direct sunlight

This is a publication by Conrad Electronic SE, Klaus-Conrad-Str. 1, D-92240 Hirschau (www.conrad.com).

All rights including translation reserved. Reproduction by any method, e.g. photocopy, microfilming, or the capture in electronic data processing systems require the prior written approval by the editor. Reprinting, also in part, is prohibited. This publication represents the technical status at the time of printing.

© Copyright 2017 by Conrad Electronic SE.