

Datasheet

Item no. 1586586

V1_0617_02_EN

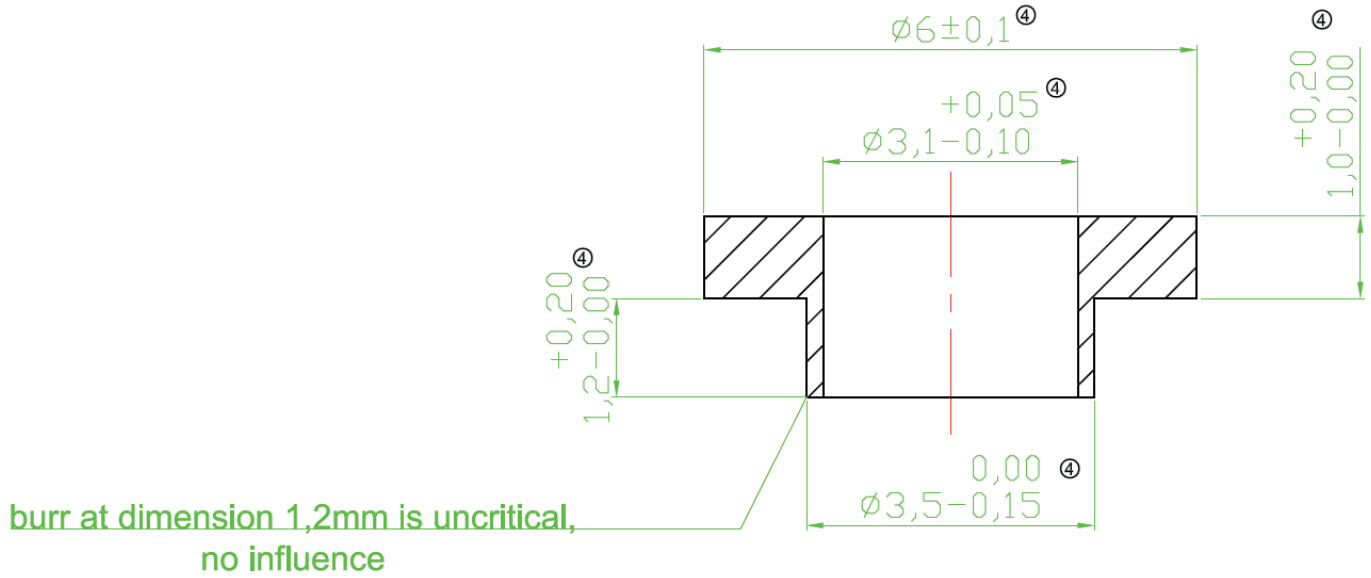

Notes
Material:SR25
Dielectric strength: 380kV/cm
Heat resistance:215°C
Tensile strength: 80N/mm

RoHS compliant
Unit: mm