

## Datasheet

Item no. 1586597

V1\_0617\_02\_EN

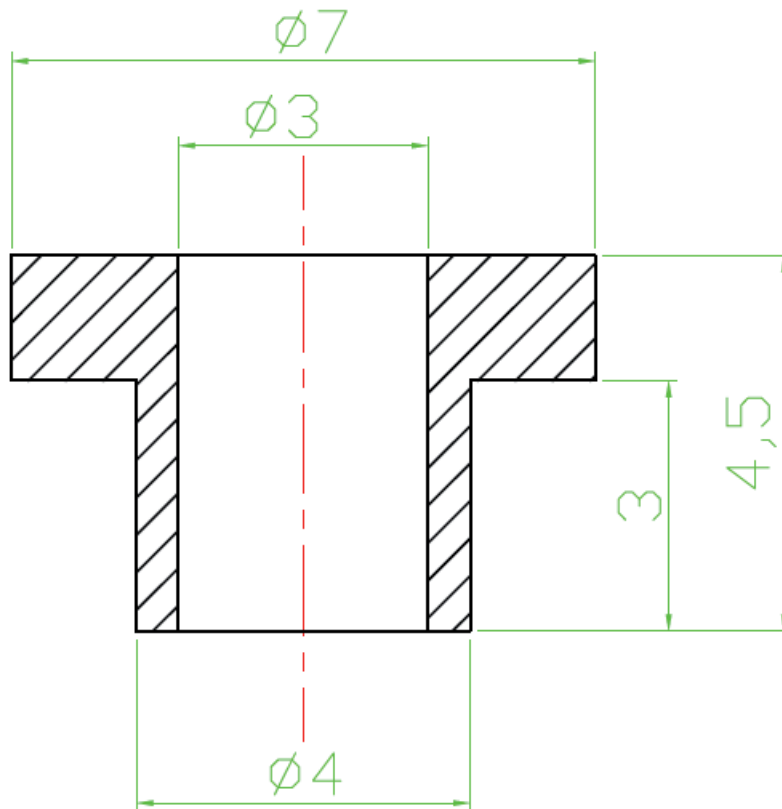

### Notes

Material:SR25

Dielectric strength: 380kV/cm

Heat resistance:215°C

Tensile strength: 80N/mm

**RoHS compliant**

Unit: mm