

Datasheet

Item no. 1586600

V1_0617_02_EN

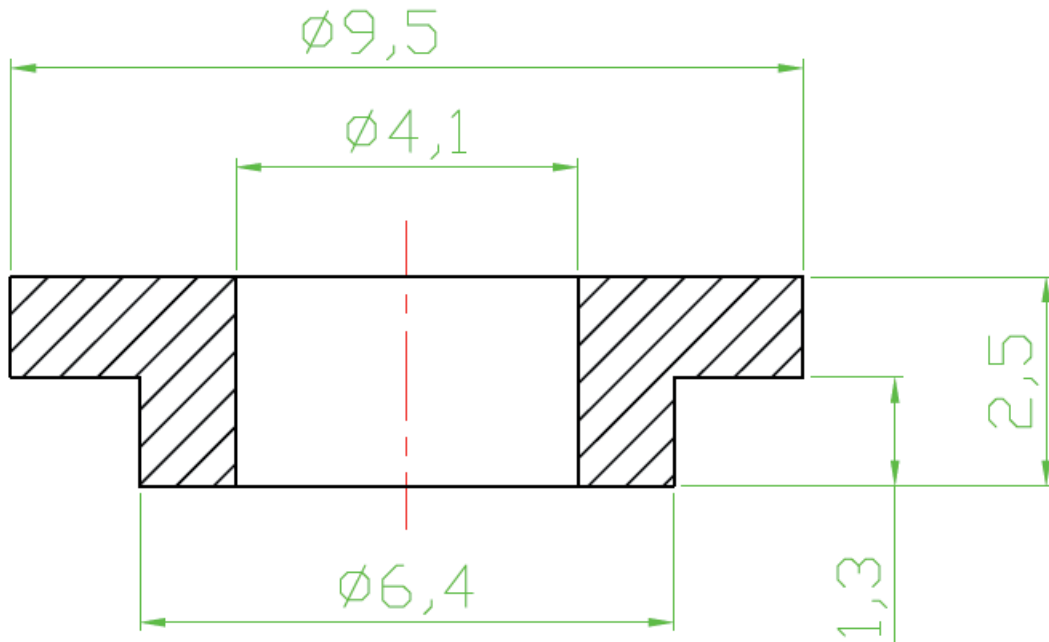

Notes

Material: SR25

Dielectric strength: 380kV/cm

Heat resistance: 215°C

Tensile strength: 80N/mm

RoHS compliant

Unit: mm