



# Rocker Switch

Rating	10(4)A 250V~ 	Mounting Hole
	16A 125V AC  10A 250V AC	
	10A 28VDC  6A 14VT	
Contact Resistance	50m ohm Max.	
Insulation Resistance	DC 500V 100M ohm Min.	
Dielectric Strength	AC 1500V 1 minute	
Operation Temperature	-20°C~125°C	
Switch Function	2P SPST ON-OFF	

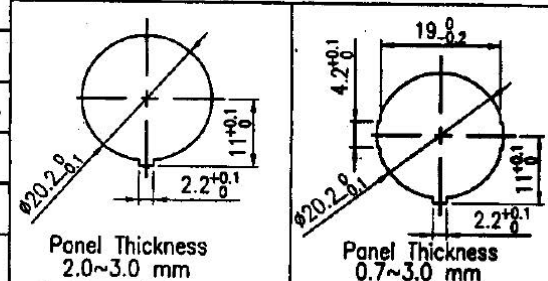
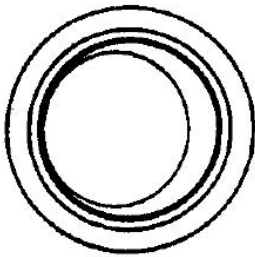

\*Material  
 Frame: Nylon#66,Black  
 Actuator: Nylon#66,Black  
 Terminal: Copper alloy,Silver plated

### Diagram

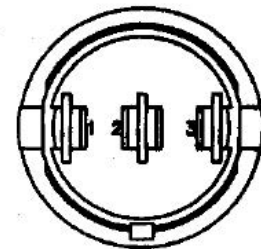
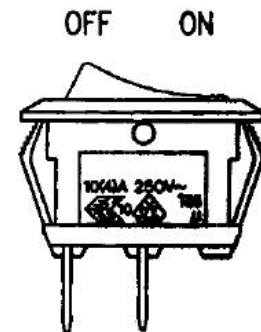
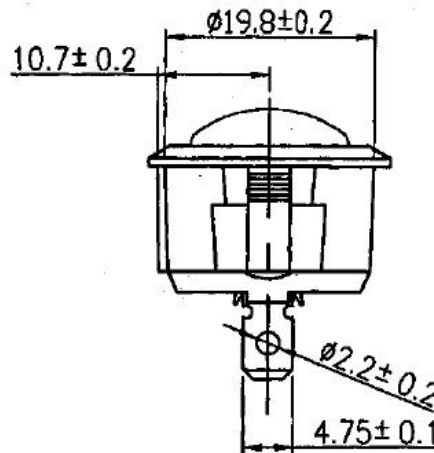
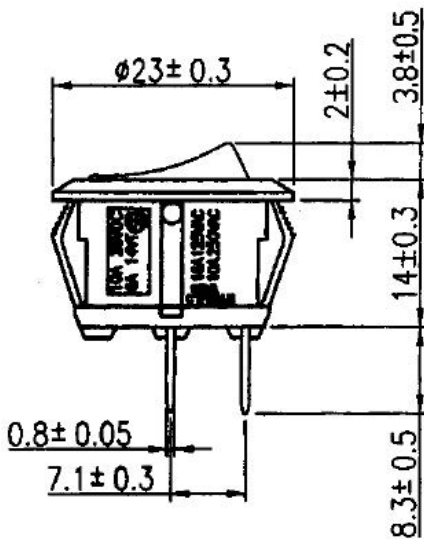
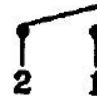

Unit: mm