



Rocker Switch

Rating	10(4)A 250V~ 	Mounting Hole
	18A 125V AC 10A 250V AC  10A 28VDC 6A 14VT 	
Contact Resistance	50m ohm Max.	 Panel Thickness 2.0~3.0 mm Panel Thickness 0.7~3.0 mm
Insulation Resistance	DC 500V 100M ohm Min.	
Dielectric Strength	AC 1500V 1 minute	Diagram
Operation Temperature	-20°~85°	
Switch Function	2P SPST ON-OFF	



*Material
 Frame: Nylon#66,Black
 Actuator: Nylon#66,Black and Red
 Terminal: Copper alloy, Silver plated

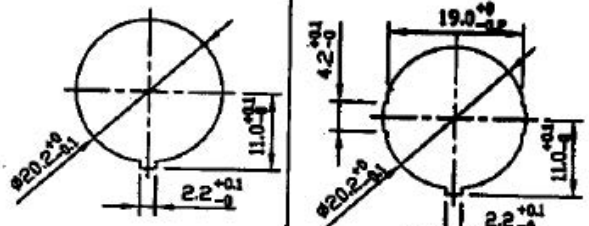
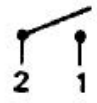
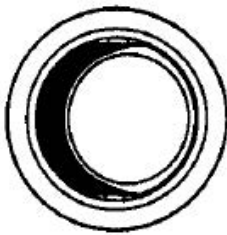
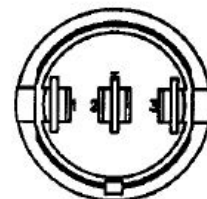
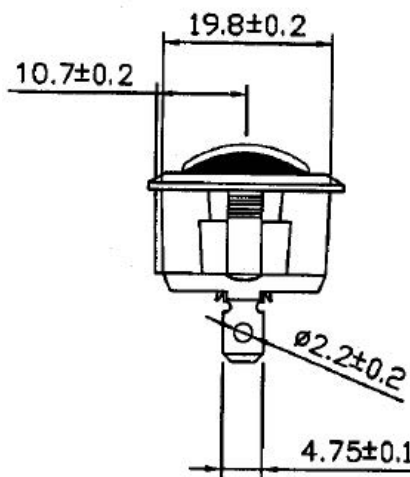
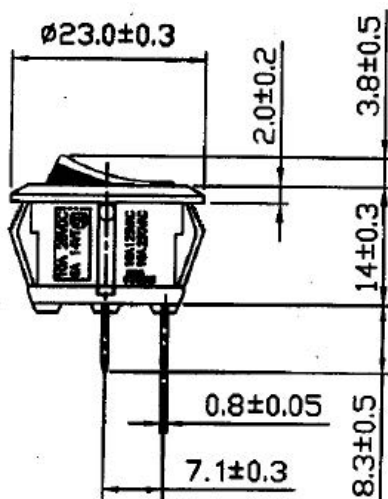

Unit: mm