





# Rocker switch 3P SPST ON-OFF (LED or Lamp)

Rating	10(4)A 250V~ 	Mounting Hole
	16A 125V AC 	
	10A 250V AC 	
	10A 28VDC 	
	6A 14VT 	
Contact Resistance	50m ohm Max.	
Insulation Resistance	DC 500V 100M ohm Min.	
Dielectric Strength	AC 1500V 1 minute	
Operation Temperature	-20°C~85°C	
Switch Function	3P SPST ON-OFF (Illuminated)	



\*Material  
 Frame: Nylon#66,Black  
 Lens: PC  
 Terminal: Copper alloy,Silver plated

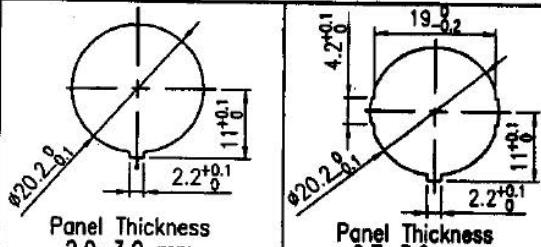
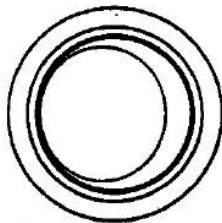
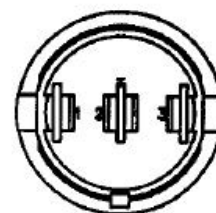
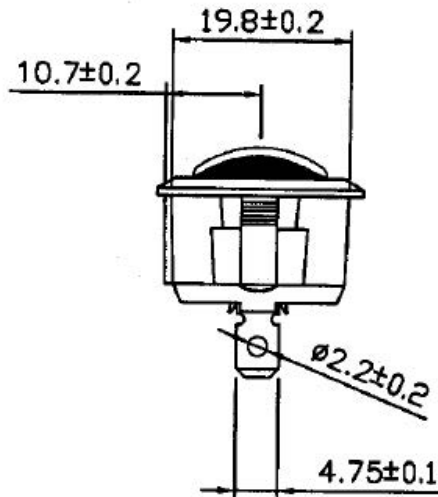
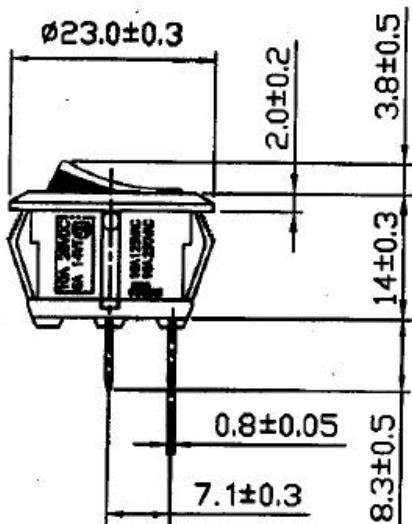
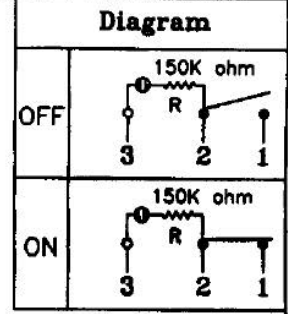

Unit: mm