

Data Sheet

Rocker Switch: R13-208C-02

Rating	10A 125VAC, 6A 250VAC. CQC	Mounting Hole 	
	10(4)A 125/250VAC 		
	16A 125VAC, 10A 250VAC 		
Contact Resistance	50m ohm Max.		
Insulation Resistance	DC 500V 100M ohm Min.		
Dielectric Strength	AC 1500V 1 minute		
Operation Temperature	-25°C~85°C		
Switch Function	3P SPDT ON-ON	Panel Thickness: 2.0~3.0 mm	

Circuit Diagram

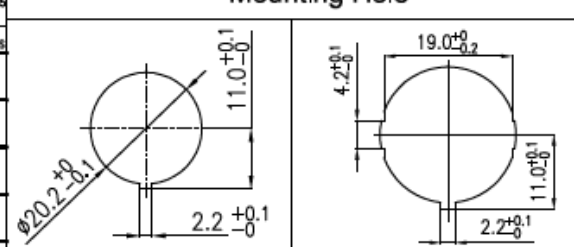
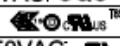
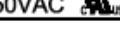

Material:
 Frame: Nylon#66, Black
 Actuator: Nylon#66, Black
 Terminals: Silver plated, Copper alloy

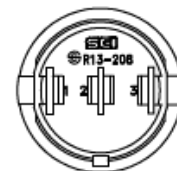
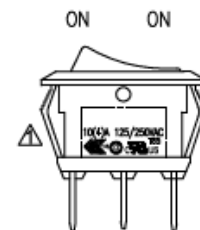
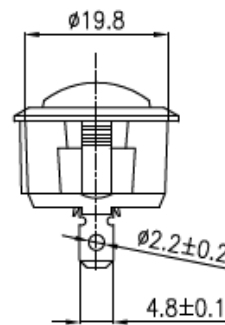
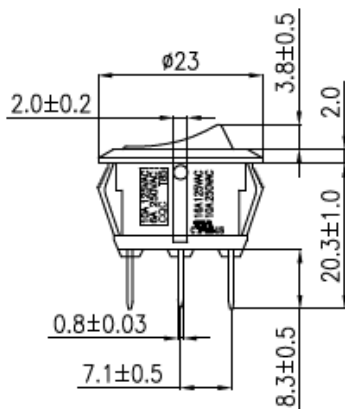

原稿
 2021/09/08
 研發部

Tolerances ±0.3mm Unless Otherwise Specified