



Datasheet

Item no. 1587657

V1_0817_01_en

Rocker Switch

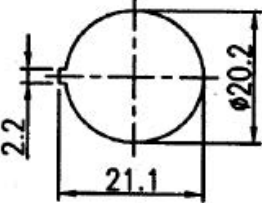
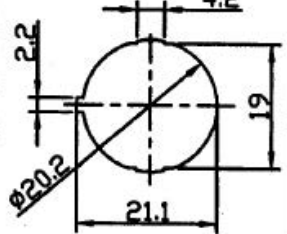
Rating	10(4)A 250V AC   16A 125V AC 10A 250V AC 	Mounting Hole  	
Contact Resistance	50m ohm Max.		
Insulation Resistance	DC 500V 100M ohm Min.		
Dielectric Strength	AC 1500V 1 minute		
Operation Temperature	-20~85°		
Operation Force	800g±200g		
Switch Function	4P DPST ON-OFF (Illuminated)		

*Material
 Frame: Nylon#66, Black
 Lens: PC
 Terminal: Copper alloy, Silver plated

Diagram

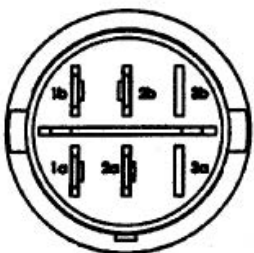
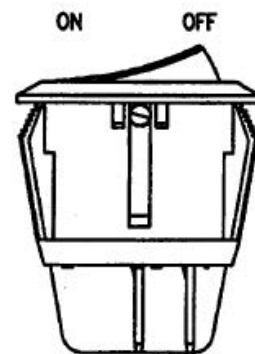
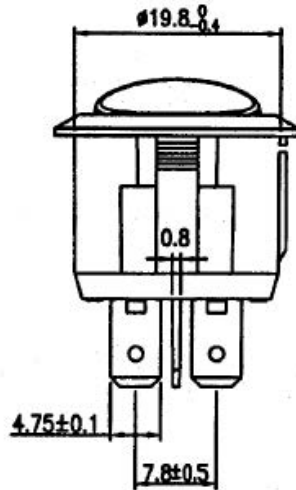
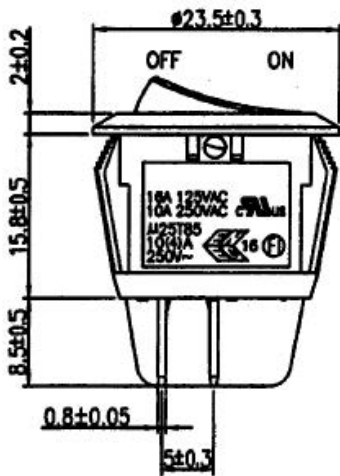
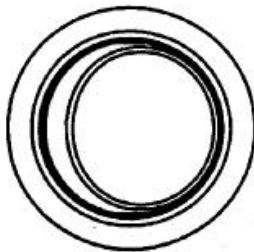
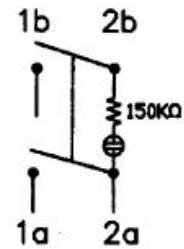

1822466	Red	Yellow clear
1821915	Red	Red clear
1821909	Green	Green clear
SCI NO.	Neon Light Color	Lens Color

Unit: mm