

## Toggle Switch

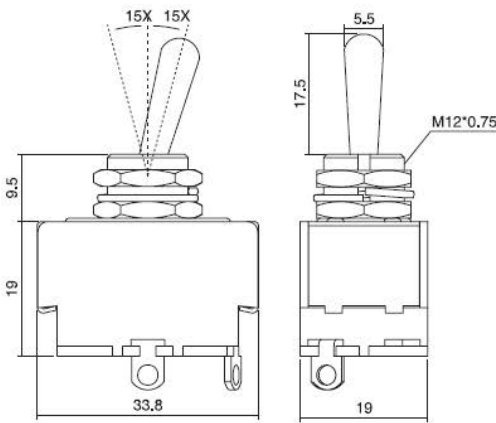

70 10 24-12

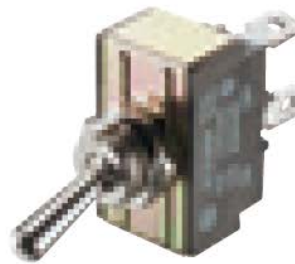

70 11 92-12



70 10 29-12

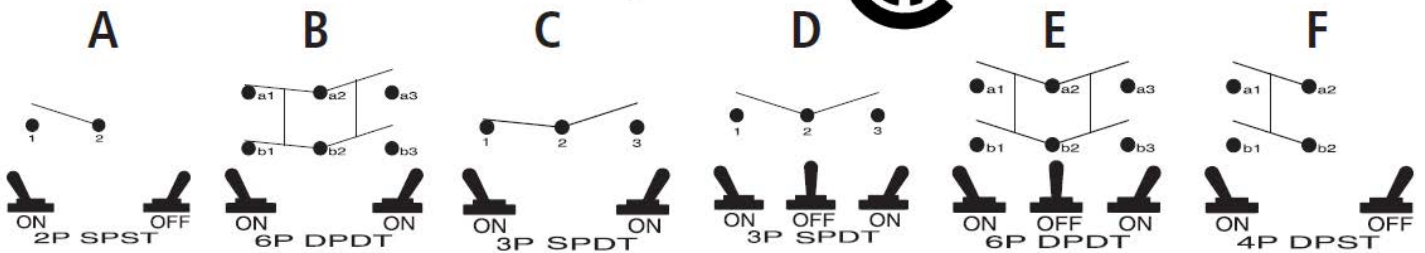

Kippschalter mit Rahmen aus Nylon ·  
Anschlüsse Messing vernickelt · Phenol-  
harz Grundplatte · Mit Führungsnut für  
Frontplatteneinbau.

**Technische Daten:** Schaltleistung  
125 V/AC 15 A, 250 V/AC 10 A · Kontakt-

widerstand 50 mΩ max. · Isolations-  
widerstand DC 500 V 100 MΩ min. ·  
Spannungsfestigkeit AC 1500 V/60 s ·  
Einbau-Ø 12,2 · Max. Frontplattenstärke  
4 mm.

## Toggle Switch

Best.-Nr.	Hersteller-bez.	Typ	Ausf.	Anschluss
70 11 92-12	R13-28A-01	1pol.	EIN/AUS	Flachstecker
70 10 23-12	R13-28B-01	2pol.	EIN/EIN	Flachstecker
70 12 12-12 <b>NEU!</b>	R13-28C-01	1pol.	EIN/EIN	Flachstecker
70 12 14-12 <b>NEU!</b>	R13-28D-01	1pol.	EIN/AUS/EIN	Flachstecker
70 10 24-12	R13-28E-01	2pol.	EIN/AUS/EIN	Flachstecker
70 10 26-12	R13-28F-01	2pol.	EIN/AUS	Flachstecker
70 11 93-12	R13-28A-06	1pol.	EIN/AUS	Schraubanschl.
70 10 27-12	R13-28B-06	2pol.	EIN/EIN	Schraubanschl.
70 12 13-12 <b>NEU!</b>	R13-28C-06	1pol.	EIN/EIN	Schraubanschl.
70 12 15-12 <b>NEU!</b>	R13-28D-06	1pol.	EIN/AUS/EIN	Schraubanschl.
70 10 28-12	R13-28E-06	2pol.	EIN/AUS/EIN	Schraubanschl.
70 10 29-12	R13-28F-06	2pol.	EIN/AUS	Schraubanschl.

## Toggle Switch

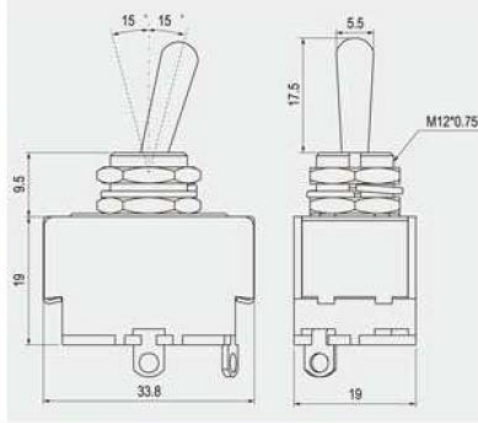

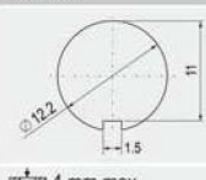
<b>Rating</b>	15A 125V AC 10A 250V AC
<b>Contact resistance</b>	50mΩ Max
<b>Insulation resistance</b>	DC 500V 100MΩ Min
<b>Dielectric strength</b>	AC 1500V 1 minute
<b>Cut-out</b>	

### FEATURES

- \* MATERIAL: Metal lever and bushing are nickel plated metal. Frame is metal plated steel. Terminals are nickel plated brass. Base is phenolic.
- \* Standard toggle lever.
- \* Indicator plate, waterproof boot, safety cover and connector are optional.













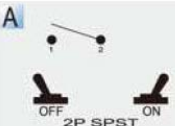
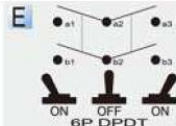
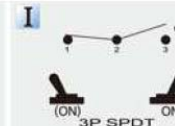
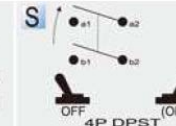

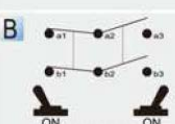
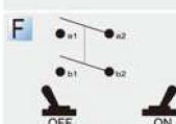
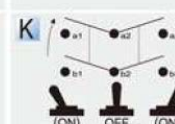
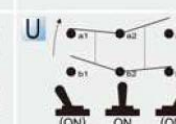
For safety cover, Pts refer to page 7.4 (R17-199)

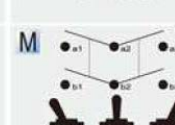

For wire connector, Pts refer to page 7.1 (R4-93)



For waterproof boot, Pts refer to page 7.2 (R1-199)

FUNCTION				TERMINAL
<b>A</b>  2P SPST	<b>E</b>  6P DPDT	<b>I</b>  3P SPDT	<b>S</b>  4P DPST	0 1  .250" SQ
<b>B</b>  6P DPDT	<b>F</b>  4P DPST	<b>K</b>  6P DPDT	<b>U</b>  6P DPDT	0 5  SO
<b>C</b>  3P SPDT	<b>G</b>  3P SPDT	<b>M</b>  6P DPDT	<b>L</b>  6P DPDT	0 6  SC 3
<b>D</b>  3P SPDT	<b>H</b>  3P SPDT	<b>P</b>  6P DPDT		0 7  SC 4

\* ( ) =momentary

This is a publication by Conrad Electronic SE, Klaus-Conrad-Str. 1, D-92240 Hirschau (www.conrad.com).

All rights including translation reserved. Reproduction by any method, e.g. photocopy, microfilming, or the capture in electronic data processing systems require the prior written approval by the editor. Reprinting, also in part, is prohibited. This publication represents the technical status at the time of printing.