

Toggle Switch RED LED (printing CSA)

Rating	10A 125V, 6A 250V AC 	Mounting Hole		Circuit Diagram	
Contact Resistance	50m ohm Max.				
Insulation Resistance	DC 500V 100M ohm Min.				
Dielectric Strength	AC 1500V 1 minute				
Switch Function	4P SPST ON-OFF (LED Independent)				

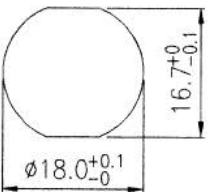

Material:
Frame: Black, Nylon 66
Toggle: Black, Nylon 66

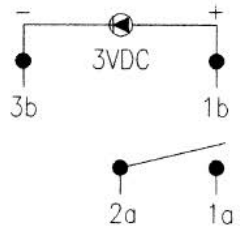
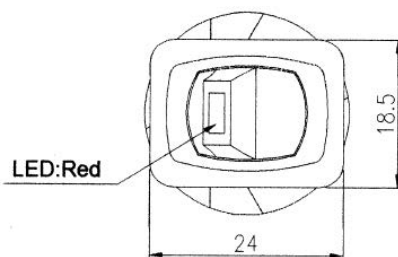
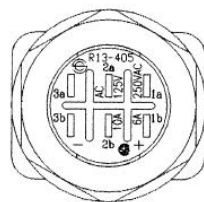
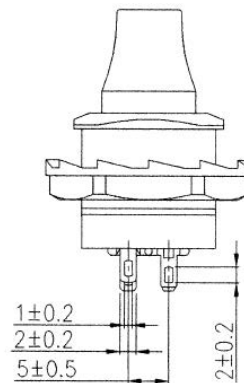
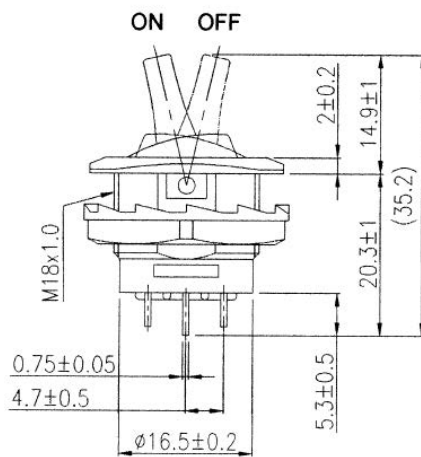

Tolerances ±0.3 Unless Otherwise Specified

Unit: mm

This is a publication by Conrad Electronic SE, Klaus-Conrad-Str. 1, D-92240 Hirschau (www.conrad.com).

All rights including translation reserved. Reproduction by any method, e.g. photocopy, microfilming, or the capture in electronic data processing systems require the prior written approval by the editor. Reprinting, also in part, is prohibited. This publication represents the technical status at the time of printing.

© Copyright 2017 by Conrad Electronic SE.